

#### CARMEN-W-C-WHT

~55° wide beam. Assembly with holder C compatible with HEKLA sockets and connectors. White version.

#### TECHNICAL SPECIFICATIONS:

Dimensions	Ø 69.5 mm
Height	41.5 mm
Fastening	socket
ROHS compliant	yes ⓘ

#### MATERIAL SPECIFICATIONS:

Component	Type	Material	Colour	Finish
CARMEN-W	Single lens	PMMA	clear	
CARMEN-HLD-C-WHT	Holder	PC	white	



#### ORDERING INFORMATION:

Component		Qty in box	MOQ	MPQ	Box weight (kg)
CP16939_CARMEN-W-C-WHT	Single lens	150	150	15	6.2
» Box size: 476 x 273 x 292 mm					

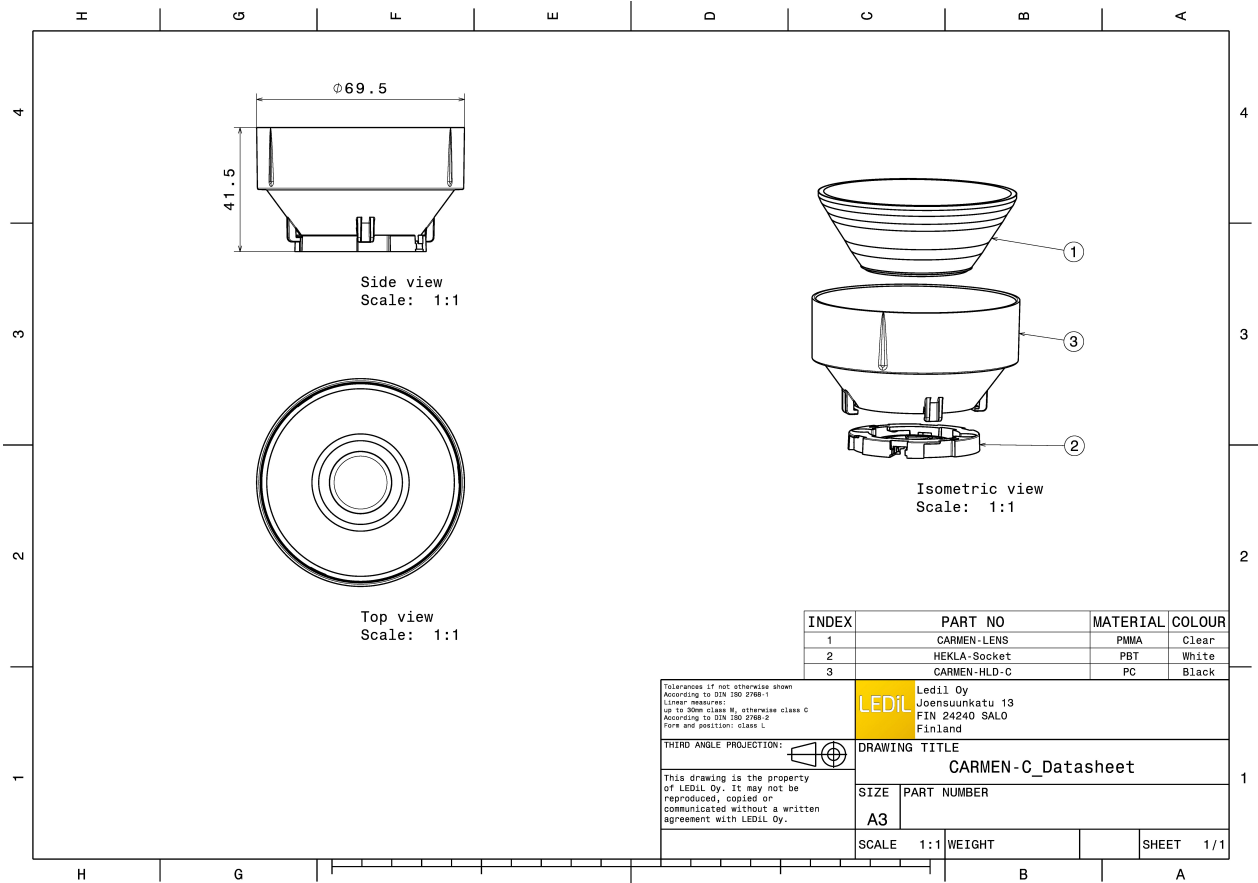

#### PHOTOMETRIC DATA (MEASURED):

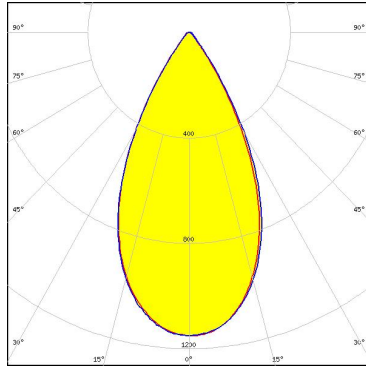
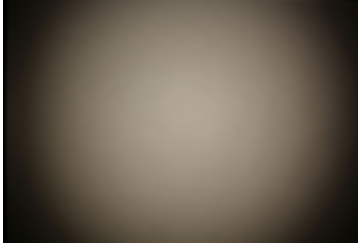
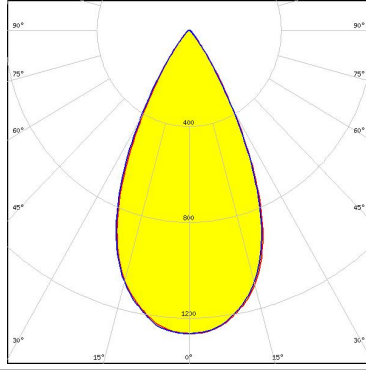
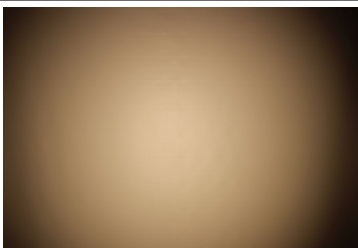
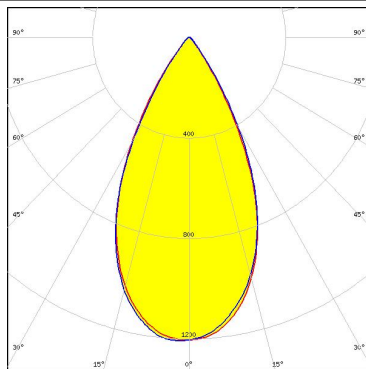
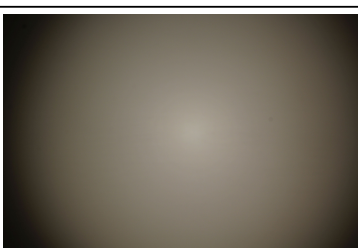
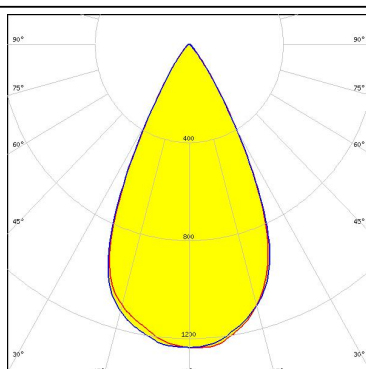
<p>bridgelux</p> <p>LED Vesta TW 9mm (9W) DP            FWHM 52.0°            Efficiency 88 %            Peak intensity 1.2 cd/lm            LEDs/each optic 1            Light colour White            Required components:            C16142_HEKLA-SOCKET-K            Bender Wirth: 489 Typ L8</p>		
<p><b>CITIZEN</b></p> <p>LED CLU700/701/702            FWHM 52.0°            Efficiency 92 %            Peak intensity 1.3 cd/lm            LEDs/each optic 1            Light colour White            Required components:            F15255_HEKLA-SOCKET-C</p>		
<p><b>CITIZEN</b></p> <p>LED CLU710/711            FWHM 53.0°            Efficiency 89 %            Peak intensity 1.2 cd/lm            LEDs/each optic 1            Light colour White            Required components:            F15859_HEKLA-SOCKET-I</p>		
<p><b>CITIZEN</b></p> <p>LED CLU7B2            FWHM 53.0°            Efficiency 93 %            Peak intensity 1.2 cd/lm            LEDs/each optic 1            Light colour White            Required components:            F15255_HEKLA-SOCKET-C</p>		

#### PHOTOMETRIC DATA (MEASURED):



LED CXA/B 15xx  
 FWHM 55.0°  
 Efficiency 91 %  
 Peak intensity 1.1 cd/lm  
 LEDs/each optic 1  
 Light colour White  
 Required components:  
 F15256\_HEKLA-SOCKET-D

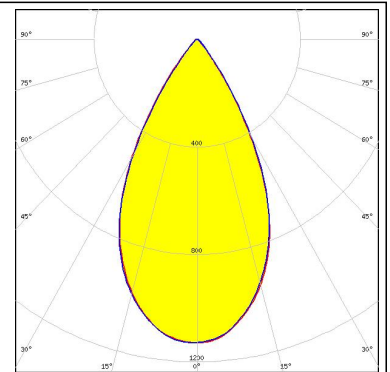
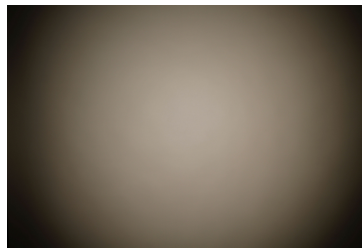

LED LUXEON CX Plus CoB - HD S01H4  
 FWHM 50.0°  
 Efficiency 89 %  
 Peak intensity 1.3 cd/lm  
 LEDs/each optic 1  
 Light colour White  
 Required components:  
 Bender Wirth: 634c Hekla

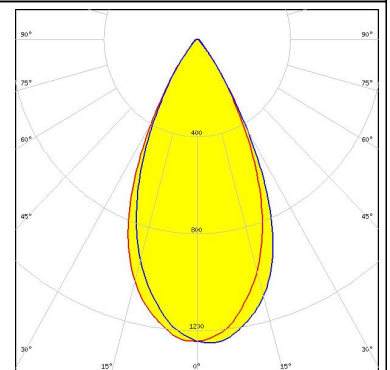
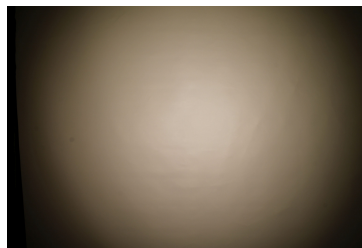

LED LUXEON CX Plus CoB - HD S01H6 / HD S02H6  
 FWHM 51.0°  
 Efficiency 89 %  
 Peak intensity 1.2 cd/lm  
 LEDs/each optic 1  
 Light colour White  
 Required components:  
 Bender Wirth: 634c Hekla

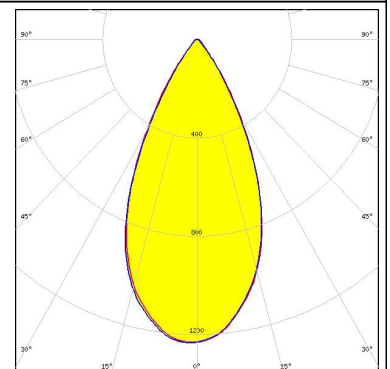

LED LUXEON CX Plus CoB - HD S04H9  
 FWHM 53.0°  
 Efficiency 88 %  
 Peak intensity 1.1 cd/lm  
 LEDs/each optic 1  
 Light colour White  
 Required components:  
 Bender Wirth: 634c Hekla

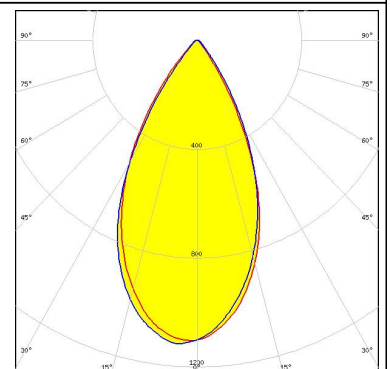
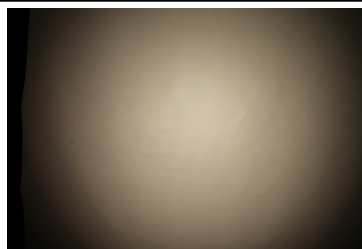

#### PHOTOMETRIC DATA (MEASURED):

#### LUMILEDS

LED LUXEON Fusion 21-up (20x24)  
 FWHM 48.0°  
 Efficiency 88 %  
 Peak intensity 1.3 cd/lm  
 LEDs/each optic 21  
 Light colour White  
 Required components:  
 C16142\_HEKLA-SOCKET-K  
 Bender Wirth: 442 Typ L8

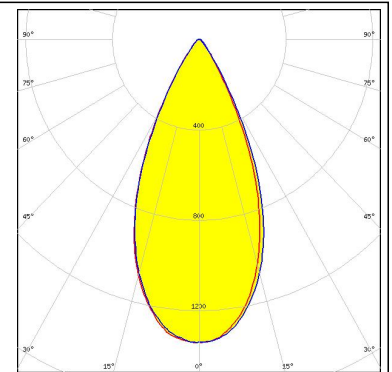

#### LUMINUS

LED CXM-3  
 FWHM 53.0°  
 Efficiency 95 %  
 Peak intensity 1.3 cd/lm  
 LEDs/each optic 1  
 Light colour White  
 Required components:  
 F15255\_HEKLA-SOCKET-C

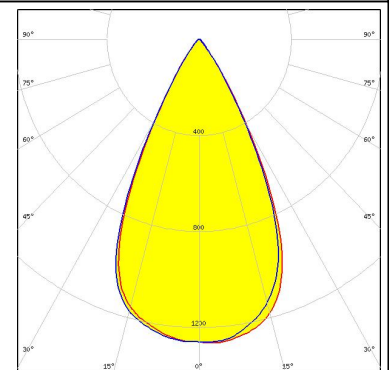
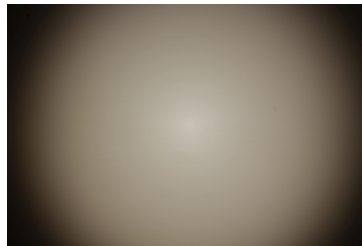

#### LUMINUS

LED CXM-4  
 FWHM 52.0°  
 Efficiency 92 %  
 Peak intensity 1.3 cd/lm  
 LEDs/each optic 1  
 Light colour White  
 Required components:  
 F15255\_HEKLA-SOCKET-C

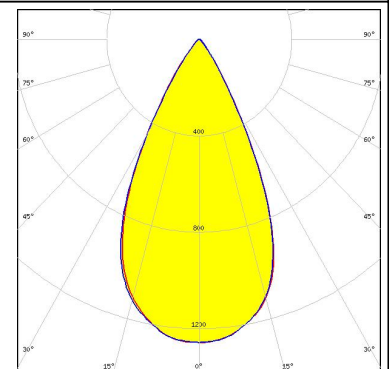
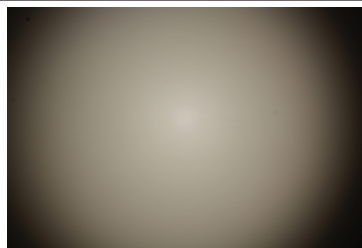

#### SAMSUNG

LED LC010T (Tunable White)  
 FWHM 52.0°  
 Efficiency 87 %  
 Peak intensity 1.2 cd/lm  
 LEDs/each optic 1  
 Light colour Tunable White  
 Required components:  
 C16142\_HEKLA-SOCKET-K  
 Bender Wirth: 501 Typ L8

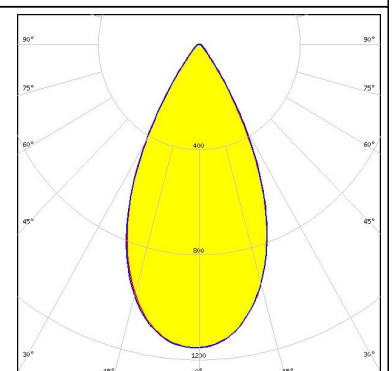
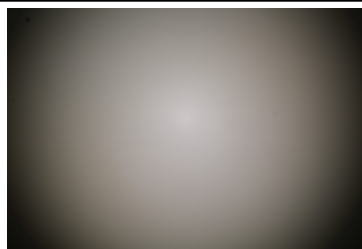

### PHOTOMETRIC DATA (MEASURED):

#### XICATO

LED XOB 6 mm  
FWHM 54.0°  
Efficiency 91 %  
Peak intensity 1.2 cd/lm  
LEDs/each optic 1  
Light colour White  
Required components:  
F15255\_HEKLA-SOCKET-C

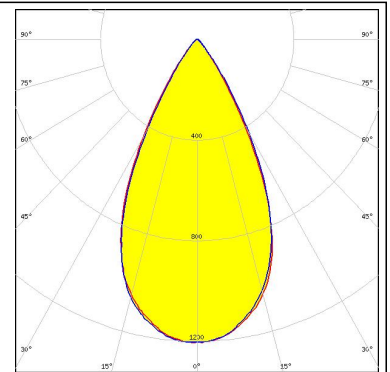

#### XICATO

LED XOB 9.8 mm  
FWHM 54.0°  
Efficiency 90 %  
Peak intensity 1.1 cd/lm  
LEDs/each optic 1  
Light colour White  
Required components:  
F15255\_HEKLA-SOCKET-C

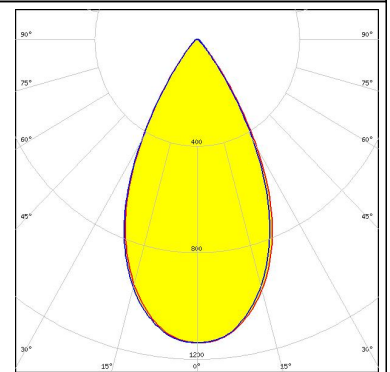
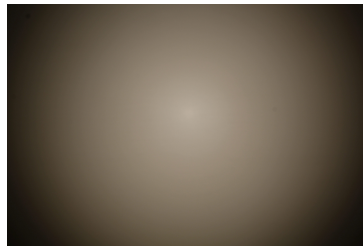

## PHOTOMETRIC DATA (SIMULATED):

### CITIZEN

LED	CLL02x/CLU02x (LES10)
FWHM	54.0°
Efficiency	87 %
Peak intensity	1.2 cd/lm
LEDs/each optic	1
Light colour	White
Required components:	

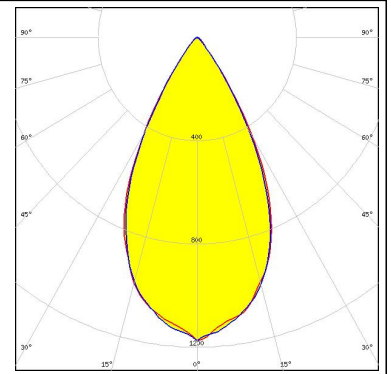

#### GENERAL INFORMATION:

NOTE: The typical beam angle will be changed by different color, chip size and chip position tolerance. The typical total beam angle is the full angle measured where the luminous intensity is half of the peak value.

Due to use of high power COB's with this product, special attention to proper thermal design is highly recommended. LEDiL has no liability for direct, indirect or consecutive damages arising from the LEDiL products being used outside of the recommended temperature range.

#### MATERIALS:

As part of our continuous research and improvement processes, and to ensure the best possible quality and availability of our products, LEDiL reserves the right to change material grades without notice.

#### PRODUCT DATA USER AGREEMENT AND DISCLAIMER:

The measured data in the provided downloadable LEDiL Product Datasheets and Mechanical 2D-Drawings is rounded and provided as reference for planning. LEDiL Oy's optical specifications have been verified by conducting performance testing of the products in accordance with the company's quality system. The reported data are averaged results of multiple measurements with typical variation. LEDiL Oy reserves the right to without prior notification make changes and improvements to its products.

LEDiL Oy assumes neither warranty, nor guarantee nor any other liability of any kind for the contents and correctness of the provided data. The provided data has been generated with highest diligence but the provided data may in reality not represent the complete possible variation range of all intrinsic parameters. Therefore, in certain cases a deviation from the provided data could occur.

LEDiL Oy reserves the right to undertake technical changes of its products without further notification which could lead to changes in the provided data. LEDiL Oy assumes no liability of any kind for the possible deviation from any provided data or any other damage resulting from the usage of the provided data.

The user agrees to this disclaimer and user agreement with the download or usage of the provided files.

#### LEDiL Oy

Joensuunkatu 13  
FI-24240 SALO  
Finland

#### LEDiL Inc.

228 West Page Street  
Suite D  
Sycamore IL 60178  
USA

#### Local sales and technical support

[www.ledil.com/  
where\\_to\\_buy](http://www.ledil.com/where_to_buy)

#### Shipping locations

Salo, Finland  
Hong Kong, China

#### Distribution Partners

[www.ledil.com/  
where\\_to\\_buy](http://www.ledil.com/where_to_buy)



Компания «Океан Электроники» предлагает заключение долгосрочных отношений при поставках импортных электронных компонентов на взаимовыгодных условиях!

Наши преимущества:

- Поставка оригинальных импортных электронных компонентов напрямую с производств Америки, Европы и Азии, а так же с крупнейших складов мира;
- Широкая линейка поставок активных и пассивных импортных электронных компонентов (более 30 млн. наименований);
- Поставка сложных, дефицитных, либо снятых с производства позиций;
- Оперативные сроки поставки под заказ (от 5 рабочих дней);
- Экспресс доставка в любую точку России;
- Помощь Конструкторского Отдела и консультации квалифицированных инженеров;
- Техническая поддержка проекта, помощь в подборе аналогов, поставка прототипов;
- Поставка электронных компонентов под контролем ВП;
- Система менеджмента качества сертифицирована по Международному стандарту ISO 9001;
- При необходимости вся продукция военного и аэрокосмического назначения проходит испытания и сертификацию в лаборатории (по согласованию с заказчиком);
- Поставка специализированных компонентов военного и аэрокосмического уровня качества (Xilinx, Altera, Analog Devices, Intersil, Interpoint, Microsemi, Actel, Aeroflex, Peregrine, VPT, Syfer, Eurofarad, Texas Instruments, MS Kennedy, Miteq, Cobham, E2V, MA-COM, Hittite, Mini-Circuits, General Dynamics и др.);

Компания «Океан Электроники» является официальным дистрибьютором и эксклюзивным представителем в России одного из крупнейших производителей разъемов военного и аэрокосмического назначения «JONHON», а так же официальным дистрибьютором и эксклюзивным представителем в России производителя высокотехнологичных и надежных решений для передачи СВЧ сигналов «FORSTAR».



## JONHON

«JONHON» (основан в 1970 г.)

Разъемы специального, военного и аэрокосмического назначения:

(Применяются в военной, авиационной, аэрокосмической, морской, железнодорожной, горно- и нефтедобывающей отраслях промышленности)

«FORSTAR» (основан в 1998 г.)

ВЧ соединители, коаксиальные кабели, кабельные сборки и микроволновые компоненты:

(Применяются в телекоммуникациях гражданского и специального назначения, в средствах связи, РЛС, а так же военной, авиационной и аэрокосмической отраслях промышленности).



Телефон: 8 (812) 309-75-97 (многоканальный)

Факс: 8 (812) 320-03-32

Электронная почта: [ocean@oceanchips.ru](mailto:ocean@oceanchips.ru)

Web: <http://oceanchips.ru/>

Адрес: 198099, г. Санкт-Петербург, ул. Калинина, д. 2, корп. 4, лит. А