

### »» Features



- 10A general purpose Power Relay.
- Both available 0.25 and 0.187 terminals.
- SPDT, DPDT, TPDT contact configurations.
- AC & DC coils are both available.
- Optional for anti-rotation tab, tapped core, indicator lamp & push-to-test button, flanged cover.
- Comply with RoHS-Directive 2002/95/EC.

### »» Type List

#### ◆ 731

| Terminal style | Contact form | Enclosure style |            |               |                   |             |
|----------------|--------------|-----------------|------------|---------------|-------------------|-------------|
|                |              | Open type       | Dust cover | Ears on cover | Antirotation -tab | Ears on top |
| Quick terminal | 1A (SPNO)    | 731-SPNO        | 731-SPNO-C | 731-SPNO-C1   | 731-SPNO-C2       | 731-SPNO-C3 |
|                | 1C (SPDT)    | 731-SPDT        | 731-SPDT-C | 731-SPDT-C1   | 731-SPDT-C2       | 731-SPDT-C3 |
|                | 2A (DPNO)    | 731-DPNO        | 731-DPNO-C | 731-DPNO-C1   | 731-DPNO-C2       | 731-DPNO-C3 |
|                | 2C (DPDT)    | 731-DPDT        | 731-DPDT-C | 731-DPDT-C1   | 731-DPDT-C2       | 731-DPDT-C3 |
|                | 3A (TPNO)    | 731-TPNO        | 731-TPNO-C | 731-TPNO-C1   | 731-TPNO-C2       | 731-TPNO-C3 |
|                | 3C (TPDT)    | 731-TPDT        | 731-TPDT-C | 731-TPDT-C1   | 731-TPDT-C2       | 731-TPDT-C3 |

#### ◆ 731H

| Terminal style | Contact form | Enclosure style |               |              |
|----------------|--------------|-----------------|---------------|--------------|
|                |              | Dust cover      | Ears on cover | Ears on top  |
| Quick terminal | 1A (SPNO)    | 731H-SPNO-C     | 731H-SPNO-C1  | 731H-SPNO-C3 |
|                | 1C (SPDT)    | 731H-SPDT-C     | 731H-SPDT-C1  | 731H-SPDT-C3 |
|                | 2A (DPNO)    | 731H-DPNO-C     | 731H-DPNO-C1  | 731H-DPNO-C3 |
|                | 2C (DPDT)    | 731H-DPDT-C     | 731H-DPDT-C1  | 731H-DPDT-C3 |
|                | 3A (TPNO)    | 731H-TPNO-C     | 731H-TPNO-C1  | 731H-TPNO-C3 |
|                | 3C (TPDT)    | 731H-TPDT-C     | 731H-TPDT-C1  | 731H-TPDT-C3 |

### »» Ordering Information

731 □ - TPDT - □ □ - □  
 1 2 3 4 5 6

1. 731 -- Basic series designation
2. Blank -- Standard type  
H -- High power type
3. SPDT -- Single pole double throw  
SPNO -- Single pole normally open  
SPNC -- Single pole normally closed

- DPDT -- Double pole double throw
- DPNO -- Double pole normally open
- DPNC -- Double pole normally closed
- TPDT -- Three pole double throw
- TPNO -- Three pole normally open
- TPNC -- Three pole normally closed

- |          |   |          |                                    |
|----------|---|----------|------------------------------------|
| 4. Blank | -- Open type without frame tab                          | 5. Blank | -- No special feature              |
| C        | -- With cover   | M        | -- With manual operator            |
| C1       | -- With mounting ears on cover                          | T        | -- Printed circuit board terminals |
| C2       | -- With accessible mounting hole with anti-rotation tab | L        | -- Pilot lamp                      |
| C3       | -- Mounting Ears on top of cover                        | 6. Blank | -- Standard type                   |
| X        | -- Open type with frame tab                             | F        | -- Class F                         |

### »» Contact Rating

|                | 731        | 731H 1P · 2P | 731H 3P    |
|----------------|------------|--------------|------------|
| Resistive load | 10A 28VDC  | 20A 300VAC   | 16A 300VAC |
|                | 10A 240VAC | 25A 277VAC   | 20A 277VAC |

### »» Coil Rating (DC)

| Rated voltage (V) | Rated current ±10 % at 23°C (mA) | Coil resistance ±10 % at 23°C (Ω) | Max. continuous voltage at 70°C | Pick up voltage(Max) at 23°C | Drop out voltage(Min) at 23°C | Power consumption at rated voltage |
|-------------------|----------------------------------|-----------------------------------|---------------------------------|------------------------------|-------------------------------|------------------------------------|
| 6                 | 188                              | 32                                | 140 % of rated voltage          | 75 % of rated voltage        | 10 % of rated voltage         | approx. 1.2W                       |
| 12                | 100                              | 120                               |                                 |                              |                               |                                    |
| 24                | 51                               | 472                               |                                 |                              |                               |                                    |
| 48                | 27                               | 1800                              |                                 |                              |                               |                                    |
| 110               | 11                               | 10000                             |                                 |                              |                               |                                    |
| 120               | 12                               | 10000                             |                                 |                              |                               |                                    |

### »» Coil Rating (AC)

| Rated voltage (V) | Coil resistance ±10 % at 23°C (Ω) | Max. continuous voltage at 70°C | Pick up voltage(Max) at 23°C | Drop out voltage(Min) at 23°C | Power consumption at rated voltage |               |
|-------------------|-----------------------------------|---------------------------------|------------------------------|-------------------------------|------------------------------------|---------------|
| SP<br>DP          | 12                                | 21                              | 110 % of rated voltage       | 85 % of rated voltage         | 30 % of rated voltage              | approx. 2.0VA |
|                   | 24                                | 85                              |                              |                               |                                    |               |
|                   | 110                               | 1700                            |                              |                               |                                    |               |
|                   | 115                               | 1700                            |                              |                               |                                    |               |
|                   | 120                               | 2250                            |                              |                               |                                    |               |
|                   | 220                               | 7200                            |                              |                               |                                    |               |
|                   | 230                               | 7200                            |                              |                               |                                    |               |
| 240               | 9110                              |                                 |                              |                               |                                    |               |

## »» Coil Rating (AC)

| Rated voltage (V) | Coil resistance $\pm 10\%$ at 23°C ( $\Omega$ ) | Max. continuous voltage at 70°C | Pick up voltage(Max) at 23°C | Drop out voltage(Min) at 23°C | Power consumption at rated voltage |               |
|-------------------|---|---------------------------------|------------------------------|-------------------------------|------------------------------------|---------------|
| TP                | 12  | 18                              | 110 % of rated voltage       | 85 % of rated voltage         | 30 % of rated voltage              | approx. 2.7VA |
|                   | 24  | 72                              |                              |                               |                                    |               |
|                   | 110   | 1300                            |                              |                               |                                    |               |
|                   | 115   | 1300                            |                              |                               |                                    |               |
|                   | 120   | 1700                            |                              |                               |                                    |               |
|                   | 220   | 5600                            |                              |                               |                                    |               |
|                   | 230   | 5600                            |                              |                               |                                    |               |
|                   | 240   | 7200                            |                              |                               |                                    |               |

## »» Specification

|                                      |   |  |
|--------------------------------------|---|--|
| Contact material                     | AgSnO alloy   |  |
| Contact resistance <sup>(1)</sup>    | 50m $\Omega$ Max. (for 731) ; 100m $\Omega$ Max. (for 731H) (1A/6VDC by 4 pipes m $\Omega$ meter) |  |
| Operate time <sup>(1)</sup>          | 20 ms Max.  |  |
| Release time <sup>(1)</sup>          | 20 ms Max.  |  |
| Insulation resistance <sup>(1)</sup> | 1000 M $\Omega$ Min. (DC 500V)  |  |
| Dielectric strength <sup>(1)</sup>   | Between open contact  | : AC 500V , 50/60Hz 1 min. (for 731)<br>: AC 1000V , 50/60Hz 1 min. (for 731H)                                 |
|                                      | Between contact and coil  | : AC 1500V , 50/60Hz 1 min. (for 731)<br>: AC 2500V , 50/60Hz 1 min. (for 731H)                                |
|                                      | Between contact circuits  | : AC 1500V , 50/60Hz 1 min. (for 731)<br>: AC 2500V , 50/60Hz 1 min. (for 731H)                                |
| Vibration resistance                 | Operating extremes  | 10~55Hz , amplitude 1.0 mm   |
|                                      | Damage limits   | 10~55Hz , amplitude 1.5 mm   |
| Shock resistance                     | Operating extremes  | 10G  |
|                                      | Damage limits   | 100G   |
| Life expectancy                      | Mechanical  | 10,000,000 operations (frequency 18,000 ops./hr)   |
|                                      | Electrical  | 100,000 operations (frequency 1,200 ops./hr) (for 731)<br>50,000 operations (frequency 360 ops./hr) (for 731H) |
| Operating ambient temperature        | -45~+70°C (no freezing) (for 731)   |  |
|                                      | AC coil : -45~+55°C (no freezing) (for 731H)<br>DC coil : -45~+65°C (no freezing)                 |  |
| Weight                               | Approx. 79.2 g  |  |

Note : (1) initial value.

# 731

## »» Safety Approval

| Certified | 731    |         |       | 731H     |
|-----------|--------|---------|-------|----------|
|           | UL     | CSA     | FIMKO | UL / CUL |
| File No.  | E88991 | 1663800 | 23797 | E88991   |

## »» Safety Approval Rating

| 731          |            | 731H 1P - 2P | 731H 3P      |
|--------------|------------|--------------|--------------|
| UL - CSA     | FIMKO      | UL / CUL     |              |
| 10A 240VAC   | 10A 250VAC | 20A 300VAC   | 16A 300VAC   |
| 10A 28VDC    |            | 25A 277VAC   | 20A 277VAC   |
| 1/3HP 120VAC |            | 1.5HP 240VAC | 1.5HP 240VAC |
| 1/2HP 240VAC |            | 1HP 120VAC   | 1HP 120VAC   |

## »» Outline Dimensions

### ◆ 731 OPEN



### ◆ 731 M

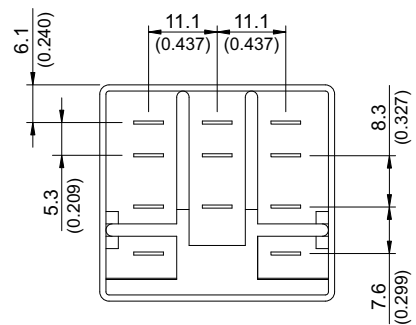

◆ 731 C



◆ 731 T



◆ 731 C2



◆ 731 C1



◆ 731 C3



»» Wiring Diagram  
BOTTOM VIEW

SPNO



DPNO



TPNO



SPNC

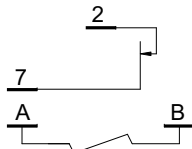

DPNC

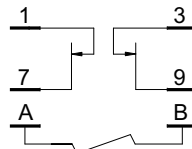

TPNC

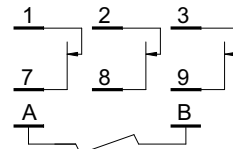

SPDT

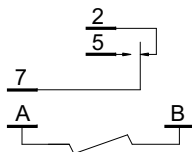

DPDT

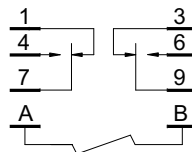

TPDT

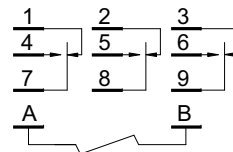

»» PC Board Layout  
BOTTOM VIEW

1P



2P



3P



## Engineering Data

◆ 731



◆ 731 H







Компания «Океан Электроники» предлагает заключение долгосрочных отношений при поставках импортных электронных компонентов на взаимовыгодных условиях!

Наши преимущества:

- Поставка оригинальных импортных электронных компонентов напрямую с производств Америки, Европы и Азии, а так же с крупнейших складов мира;
- Широкая линейка поставок активных и пассивных импортных электронных компонентов (более 30 млн. наименований);
- Поставка сложных, дефицитных, либо снятых с производства позиций;
- Оперативные сроки поставки под заказ (от 5 рабочих дней);
- Экспресс доставка в любую точку России;
- Помощь Конструкторского Отдела и консультации квалифицированных инженеров;
- Техническая поддержка проекта, помощь в подборе аналогов, поставка прототипов;
- Поставка электронных компонентов под контролем ВП;
- Система менеджмента качества сертифицирована по Международному стандарту ISO 9001;
- При необходимости вся продукция военного и аэрокосмического назначения проходит испытания и сертификацию в лаборатории (по согласованию с заказчиком);
- Поставка специализированных компонентов военного и аэрокосмического уровня качества (Xilinx, Altera, Analog Devices, Intersil, Interpoint, Microsemi, Actel, Aeroflex, Peregrine, VPT, Syfer, Eurofarad, Texas Instruments, MS Kennedy, Miteq, Cobham, E2V, MA-COM, Hittite, Mini-Circuits, General Dynamics и др.);

Компания «Океан Электроники» является официальным дистрибьютором и эксклюзивным представителем в России одного из крупнейших производителей разъемов военного и аэрокосмического назначения «JONHON», а так же официальным дистрибьютором и эксклюзивным представителем в России производителя высокотехнологичных и надежных решений для передачи СВЧ сигналов «FORSTAR».



## JONHON

«JONHON» (основан в 1970 г.)

Разъемы специального, военного и аэрокосмического назначения:

(Применяются в военной, авиационной, аэрокосмической, морской, железнодорожной, горно- и нефтедобывающей отраслях промышленности)

«FORSTAR» (основан в 1998 г.)

ВЧ соединители, коаксиальные кабели, кабельные сборки и микроволновые компоненты:

(Применяются в телекоммуникациях гражданского и специального назначения, в средствах связи, РЛС, а так же военной, авиационной и аэрокосмической отраслях промышленности).



Телефон: 8 (812) 309-75-97 (многоканальный)

Факс: 8 (812) 320-03-32

Электронная почта: [ocean@oceanchips.ru](mailto:ocean@oceanchips.ru)

Web: <http://oceanchips.ru/>

Адрес: 198099, г. Санкт-Петербург, ул. Калинина, д. 2, корп. 4, лит. А