

The S-8425 Series is a CMOS IC designed for use in the switching circuits of primary and backup power supplies on a single chip. It consists of three voltage regulators, two voltage detectors, a power supply switch and its controller, as well as other functions.

In addition to the function for switching between the primary and backup power supply, the S-8425 Series can provide microcontrollers with two types of voltage detection output signals corresponding to the power supply voltage.

Moreover, adopting a special sequence for switch control enables the effective use of the backup power supply, making this IC ideal for configuring a backup system.

■ Features

- Low power consumption
 - Normal operation: 15 μ A max. ($V_{IN} = 6$ V)
 - Backup: 2.1 μ A max.
- Voltage regulator
 - Output voltage tolerance : $\pm 2\%$
 - Output voltage: Independently selectable in 0.1 V steps in the range of 2.3 V to 5.4 V
- Two built-in voltage detectors (\overline{CS} , \overline{RESET})
 - Detection voltage tolerance: $\pm 2\%$
 - Detection voltage: Selectable in 0.1 V steps in the range of 2.4 V to 5.3 V (\overline{CS} voltage detector)
Selectable in 0.1 V steps in the range of 1.7 V to 3.4 V (\overline{RESET} voltage detector)
- \overline{RESET} release delay: 300 μ s min.
- Switching circuit for primary power supply and backup power supply configurable on one chip
- Efficient use of backup power supply possible
- Special sequence
 - Backup voltage is not output when the primary power supply voltage does not reach the initial voltage at which the switch unit operates.
- Lead-free, Sn 100%, halogen-free^{*1}

*1. Refer to "■ Product Name Structure" for details.

■ Packages

- 8-Pin TSSOP
- 8-Pin SON(B)

■ Applications

- Camcorders
- Digital cameras
- Memory cards
- SRAM backup equipment

■ **Product Name Structure**

1. Product Name

(1) 8-Pin TSSOP

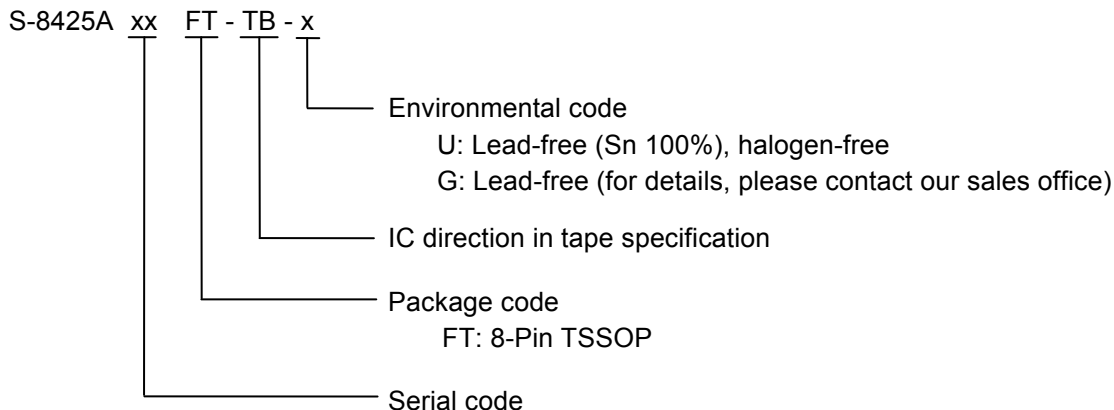

(2) 8-Pin SON(B)

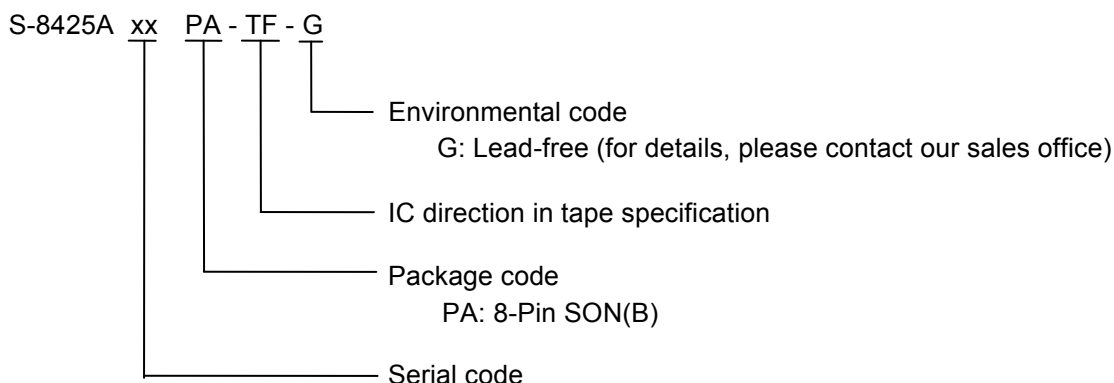

2. Packages

Package Name		Drawing Code		
		Package	Tape	Reel
8-Pin TSSOP	Environmental code = G	FT008-A-P-SD	FT008-E-C-SD	FT008-E-R-SD
	Environmental code = U	FT008-A-P-SD	FT008-E-C-SD	FT008-E-R-S1
8-Pin SON(B)		PA008-B-P-SD	PA008-B-C-SD	PA008-B-R-SD

3. Product Name List

Product Name	Package	Output Voltage (V)			CS Voltage (V)		RESET Voltage (V)		Switch Voltage (V)
		V _{RO}	V _{OUT}	V _{CH}	-V _{DET1}	+V _{DET1}	-V _{DET2}	+V _{DET2}	V _{SW1}
S-8425AAAFT-TB-x	8-Pin TSSOP	3.000	3.000	3.300	3.300	3.401	2.200	2.312	+V _{DET1} × 0.85
S-8425AAGFT-TB-U	8-Pin TSSOP	3.000	2.800	2.800	4.300	4.441	1.800	1.880	+V _{DET1} × 0.85
S-8425AAAPA-TF-G	8-Pin SON(B)	3.000	3.000	3.300	3.300	3.401	2.200	2.312	+V _{DET1} × 0.85

Caution Set the CS voltage so that the switch voltage (V_{SW1}) is equal to or greater than the RESET detection voltage (-V_{DET2}).

Remark 1 The selection range is as follows.

V _{RO} , V _{OUT} , V _{CH} :	2.3 to 5.4 V (0.1 V steps)
-V _{DET1} :	2.4 to 5.3 V (0.1 V steps)
-V _{DET2} :	1.7 to 3.4 V (0.1 V steps)
V _{SW1} :	+V _{DET1} × 0.85 or +V _{DET1} × 0.77

- Please contact our sales office for the products with a voltage other than those specified above.
- x: G or U
- Please select products of environmental code = U for Sn 100%, halogen-free products.

■ **Block Diagram**

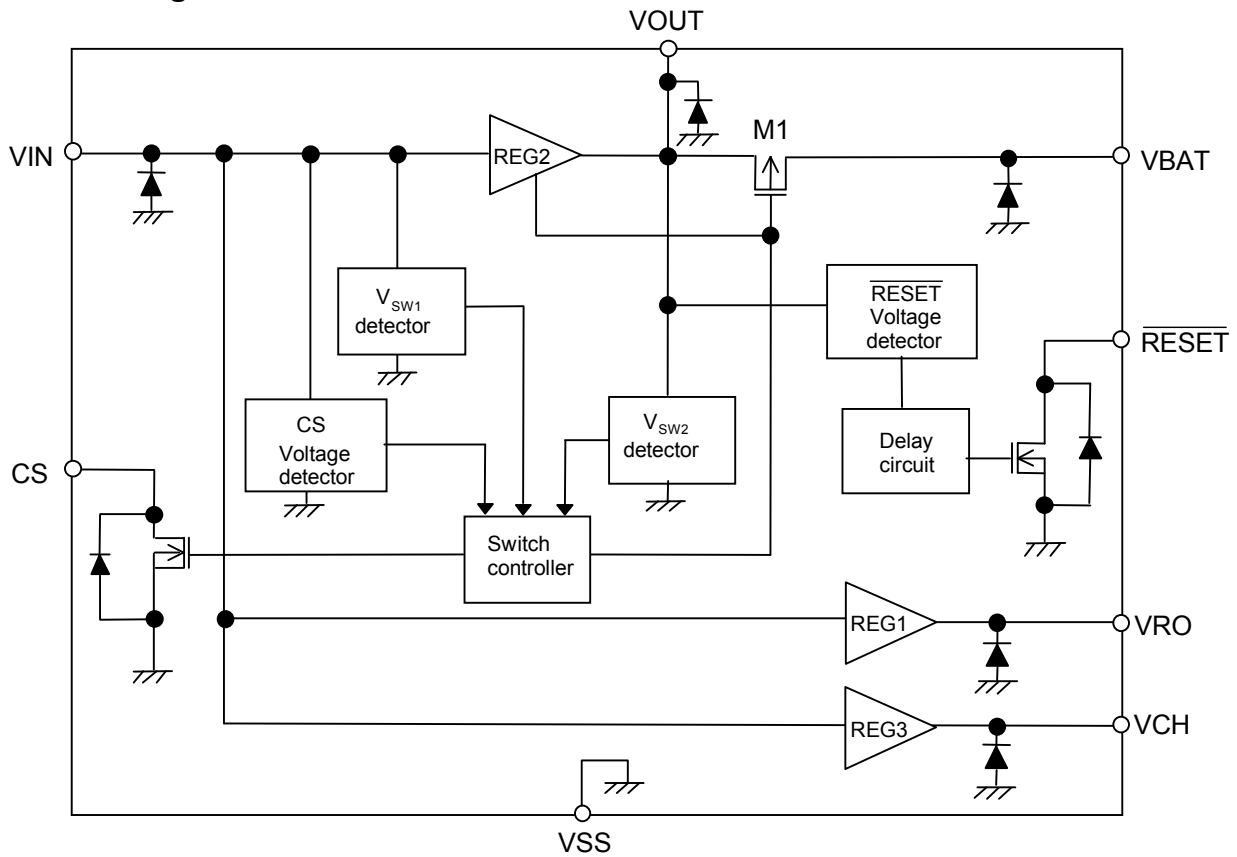
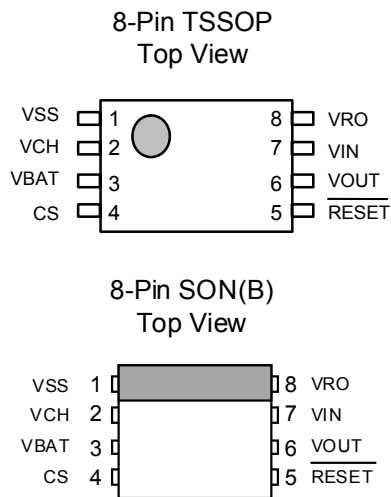

Figure 1 Block Diagram

■ Pin Configurations



Pin No.	Symbol	Description
1	VSS	Ground
2	VCH ^{*1}	Output pin of voltage regulator 3
3	VBAT ^{*1}	Backup power supply input pin
4	CS	Output pin of CS voltage detector
5	$\overline{\text{RESET}}$	Output pin of RESET voltage detector
6	VOUT ^{*1}	Output pin of voltage regulator 2
7	VIN ^{*1}	Primary power supply input pin
8	VRO ^{*1}	Output pin of voltage regulator 1

Figure 2 Pin Configurations

- *1. Mount capacitors between VSS (GND) and the VIN, VBAT, VOUT, VRO, and VCH pins (see the **Standard Circuit** section).

■ **Absolute Maximum Ratings**

Table 1 Absolute Maximum Ratings

(Ta = 25°C, unless otherwise specified)

Item	Symbol	Absolute Maximum Rating	Unit
Primary power supply input voltage	V _{IN}	V _{SS} -0.3 to V _{SS} +18	V
Backup power supply input voltage	V _{BAT}	V _{SS} -0.3 to V _{SS} +18	V
Output voltage of voltage regulator	V _{RO} , V _{OUT} , V _{CH}	V _{SS} -0.3 to V _{IN} +0.3	V
CS output voltage	V _{CS}	V _{SS} -0.3 to V _{SS} +18	V
RESET output voltage	V _{RESET}		V
Power dissipation	P _D	300 (When not mounted on board)	mW
		700*1	mW
		300 (When not mounted on board)	mW
		750*1	mW
Operating ambient temperature	T _{opr}	-40 to +85	°C
Storage temperature	T _{stg}	-40 to +125	°C

*1. When mounted on board

[Mounted board]

- (1) Board size: 114.3 mm × 76.2 mm × t1.6 mm
- (2) Board name: JEDEC STANDARD51-7

Caution The absolute maximum ratings are rated values exceeding which the product could suffer physical damage. These values must therefore not be exceeded under any conditions.

(1) When mounted on board

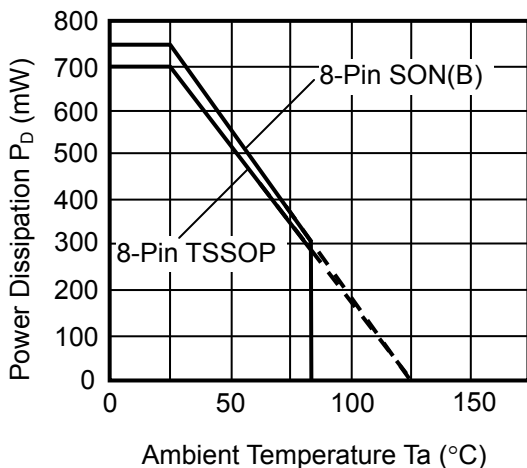

(2) When not mounted on board



Figure 3 Power Dissipation of Package

Electrical Characteristics

S-8425AAAFT, S-8425AAAPA

Table 2 Electrical Characteristics

(Ta = 25°C, Unless otherwise specified)

	Item	Symbol	Condition	Min.	Typ.	Max.	Unit	Test Circuit	
V o l t a g e r e g u l a t o r	Output voltage 1	V _{RO}	V _{IN} = 7.2 V, I _{RO} = 3 mA	2.940	3.000	3.060	V	1	
	Dropout voltage 1	V _{drop1}	I _{RO} = 3 mA	–	41	59	mV		
	Load stability 1	ΔV _{RO1}	V _{IN} = 7.2 V, I _{RO} = 100 μA to 20 mA	–	50	100	mV		
	Input stability 1	ΔV _{RO2}	V _{IN} = 4 V to 16 V, I _{RO} = 3 mA	–	5	20	mV		
	Output voltage temperature coefficient 1	$\frac{\Delta V_{RO}}{\Delta T_a \bullet V_{RO}}$	Ta = –40°C to +85°C	–	±100	–	ppm/°C		
	Output voltage 2	V _{OUT}	V _{IN} = 7.2 V, I _{OUT} = 23 mA	2.940	3.000	3.060	V		
	Dropout voltage 2	V _{drop2}	I _{OUT} = 23 mA	–	187	252	mV		
	Load stability 2	ΔV _{OUT1}	V _{IN} = 7.2 V, I _{OUT} = 100 μA to 60 mA	–	50	100	mV		
	Input stability 2	ΔV _{OUT2}	V _{IN} = 4 V to 16 V, I _{OUT} = 23 mA	–	5	20	mV		
	Output voltage temperature coefficient 2	$\frac{\Delta V_{OUT}}{\Delta T_a \bullet V_{OUT}}$	Ta = –40°C to +85°C	–	±100	–	ppm/°C		
	Output voltage 3	V _{CH}	V _{IN} = 7.2 V, I _{CH} = 3 mA	3.234	3.300	3.366	V		
	Dropout voltage 3	V _{drop3}	I _{CH} = 3 mA	–	90	120	mV		
	Load stability 3	ΔV _{CH1}	V _{IN} = 7.2 V, I _{CH} = 100 μA to 10 mA	–	50	100	mV		
	Input stability 3	ΔV _{CH2}	V _{IN} = 4.3 V to 16 V, I _{CH} = 3 mA	–	5	20	mV		
	Output voltage temperature coefficient 3	$\frac{\Delta V_{CH}}{\Delta T_a \bullet V_{CH}}$	Ta = –40°C to +85°C	–	±100	–	ppm/°C		
Primary power input voltage	V _{IN}	–	–	–	16	V			
V o l t a g e d e t e c t o r	CS detection voltage	–V _{DET1}	V _{IN} voltage detection	3.234	3.300	3.366	V	2	
	CS release voltage	+V _{DET1}	–	3.319	3.401	3.482	V		
	RESET detection voltage	–V _{DET2}	V _{OUT} voltage detection	2.156	2.200	2.244	V	9	
	RESET release voltage	+V _{DET2}	–	2.256	2.312	2.367	V		
	RESET release delay time	t _{DELAY}	–	0.3	0.8	–	ms		
Operating voltage	V _{OPF}	V _{IN} or V _{BAT}	1.7	–	16	V	2		
Detection voltage temperature coefficient		$\frac{\Delta - V_{DET1}}{\Delta T_a \bullet (-V_{DET1})}$	Ta = –40°C to +85°C	–	±100	–		ppm/°C	
		$\frac{\Delta - V_{DET2}}{\Delta T_a \bullet (-V_{DET2})}$	Ta = –40°C to +85°C	–	±100	–	ppm/°C		
Sink current	I _{SINK}	V _{DS} = 0.5 V V _{IN} = V _{BAT} = 2.0 V	RESET	1.50	2.30	–	mA	3	
			CS	1.50	2.30	–	mA		
Leakage current	I _{LEAK}	V _{DS} = 16 V, V _{IN} = 16 V	–	–	0.1	μA			
S w i t c h u n i t	Switch voltage	V _{SW1}	V _{BAT} = 2.8 V, V _{IN} voltage detection	+V _{DET1} × 0.83	+V _{DET1} × 0.85	+V _{DET1} × 0.87	V	4	
	CS output inhibit voltage	V _{SW2}	V _{BAT} = 3 V, V _{OUT} voltage detection	V _{OUT} × 0.93	V _{OUT} × 0.95	V _{OUT} × 0.97	V	5	
	V _{BAT} switch leakage current	I _{LEAK}	V _{IN} = 3.6 V, V _{BAT} = 0 V	–	–	0.1	μA	6	
	V _{BAT} switch resistance	R _{SW}	V _{IN} = Open, V _{BAT} = 3 V, I _{OUT} = 10 μA to 500 μA	–	30	60	Ω	7	
	Switch voltage temperature coefficient	$\frac{\Delta V_{SW1}}{\Delta T_a \bullet V_{SW1}}$	Ta = –40°C to +85°C	–	±100	–	ppm/°C	4	
	CS output inhibit voltage temperature coefficient	$\frac{\Delta V_{SW2}}{\Delta T_a \bullet V_{SW2}}$	Ta = –40°C to +85°C	–	±100	–	ppm/°C	5	
T o t a l	Current consumption	I _{SS1}	V _{IN} = 3.6 V, Unload	–	7	15	μA	8	
			V _{BAT} = 3 V	–	–	0.1	μA		
		I _{BAT2}	V _{IN} = Open, V _{BAT} = 3 V	Ta = 25°C	–	1.0	2.1		μA
			Unload	Ta = 85°C	–	–	3.5		μA
Backup power supply input voltage	V _{BAT}	–	2.0	–	4.0	V	7		

Remark The number in the Test Circuit column corresponds to the circuit number in the **Test Circuits** section.

S-8425AAGFT

Table 3 Electrical Characteristics

(Ta = 25°C, Unless otherwise specified)

	Item	Symbol	Condition	Min.	Typ.	Max.	Unit	Test Circuit	
V o l t a g e r e g u l a t o r	Output voltage 1	V _{RO}	V _{IN} = 7.2 V, I _{RO} = 3 mA	2.940	3.000	3.060	V	1	
	Dropout voltage 1	V _{drop1}	I _{RO} = 3 mA	–	41	59	mV		
	Load stability 1	ΔV _{RO1}	V _{IN} = 7.2 V, I _{RO} = 100 μA to 20 mA	–	50	100	mV		
	Input stability 1	ΔV _{RO2}	V _{IN} = 4 V to 16 V, I _{RO} = 3 mA	–	5	20	mV		
	Output voltage temperature coefficient 1	$\frac{\Delta V_{RO}}{\Delta T_a \bullet V_{RO}}$	Ta = –40°C to +85°C	–	±100	–	ppm/°C		
	Output voltage 2	V _{OUT}	V _{IN} = 7.2 V, I _{OUT} = 23 mA	2.744	2.800	2.856	V		
	Dropout voltage 2	V _{drop2}	I _{OUT} = 23 mA	–	187	252	mV		
	Load stability 2	ΔV _{OUT1}	V _{IN} = 7.2 V, I _{OUT} = 100 μA to 60 mA	–	50	100	mV		
	Input stability 2	ΔV _{OUT2}	V _{IN} = 3.8 V to 16 V, I _{OUT} = 23 mA	–	5	20	mV		
	Output voltage temperature coefficient 2	$\frac{\Delta V_{OUT}}{\Delta T_a \bullet V_{OUT}}$	Ta = –40°C to +85°C	–	±100	–	ppm/°C		
	Output voltage 3	V _{CH}	V _{IN} = 7.2 V, I _{CH} = 3 mA	2.744	2.800	2.856	V		
	Dropout voltage 3	V _{drop3}	I _{CH} = 3 mA	–	90	120	mV		
	Load stability 3	ΔV _{CH1}	V _{IN} = 7.2 V, I _{CH} = 100 μA to 10 mA	–	50	100	mV		
	Input stability 3	ΔV _{CH2}	V _{IN} = 3.8 V to 16 V, I _{CH} = 3 mA	–	5	20	mV		
Output voltage temperature coefficient 3	$\frac{\Delta V_{CH}}{\Delta T_a \bullet V_{CH}}$	Ta = –40°C to +85°C	–	±100	–	ppm/°C			
Primary power input voltage	V _{IN}	–	–	–	16	V			
V o l t a g e d e t e c t o r	CS detection voltage	–V _{DET1}	V _{IN} voltage detection	4.214	4.300	4.386	V	2	
	CS release voltage	+V _{DET1}	–	4.335	4.441	4.548	V		
	RESET detection voltage	–V _{DET2}	V _{OUT} voltage detection	1.764	1.800	1.836	V	9	
	RESET release voltage	+V _{DET2}	–	1.835	1.880	1.925	V		
	RESET release delay time	t _{DELAY}	–	0.3	0.8	–	ms		
	Operating voltage	V _{opr}	V _{IN} or V _{BAT}	1.7	–	16	V	2	
Detection voltage temperature coefficient	$\frac{\Delta - V_{DET1}}{\Delta T_a \bullet (-V_{DET1})}$	Ta = –40°C to +85°C	–	±100	–	ppm/°C			
	$\frac{\Delta - V_{DET2}}{\Delta T_a \bullet (-V_{DET2})}$	Ta = –40°C to +85°C	–	±100	–	ppm/°C			
Sink current	I _{SINK}	V _{DS} = 0.5 V V _{IN} = V _{BAT} = 2.0 V	RESET CS	1.50 1.50	2.30 2.30	– –	mA mA	3	
Leakage current	I _{LEAK}	V _{DS} = 16 V, V _{IN} = 16 V	–	–	0.1	μA			
S w i t c h u n i t	Switch voltage	V _{SW1}	V _{BAT} = 2.8 V, V _{IN} voltage detection	+V _{DET1} × 0.83	+V _{DET1} × 0.85	+V _{DET1} × 0.87	V	4	
	CS output inhibit voltage	V _{SW2}	V _{BAT} = 3 V, V _{OUT} voltage detection	V _{OUT} × 0.93	V _{OUT} × 0.95	V _{OUT} × 0.97	V	5	
	V _{BAT} switch leakage current	I _{LEAK}	V _{IN} = 3.6 V, V _{BAT} = 0 V	–	–	0.1	μA	6	
	V _{BAT} switch resistance	R _{SW}	V _{IN} = Open, V _{BAT} = 3 V, I _{OUT} = 10 μA to 500 μA	–	30	60	Ω	7	
	Switch voltage temperature coefficient	$\frac{\Delta V_{SW1}}{\Delta T_a \bullet V_{SW1}}$	Ta = –40°C to +85°C	–	±100	–	ppm/°C	4	
	CS output inhibit voltage temperature coefficient	$\frac{\Delta V_{SW2}}{\Delta T_a \bullet V_{SW2}}$	Ta = –40°C to +85°C	–	±100	–	ppm/°C	5	
T o t a l	Current consumption	I _{SS1}	V _{IN} = 3.6 V, Unload	–	7	15	μA	8	
		I _{BAT1}	V _{BAT} = 3 V	–	–	0.1	μA		
		I _{BAT2}	V _{IN} = Open, V _{BAT} = 3 V	Ta = 25°C	–	1.0	2.1		μA
			Unload	Ta = 85°C	–	–	3.5		μA
Backup power supply input voltage	V _{BAT}	–	2.0	–	4.0	V	7		

Remark The number in the Test Circuit column corresponds to the circuit number in the **Test Circuits** section.

■ Test Circuits

1.

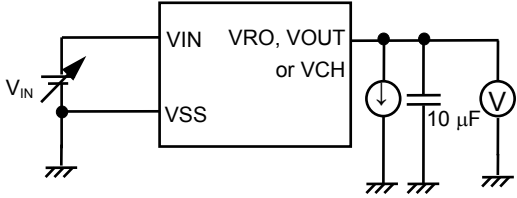

2.

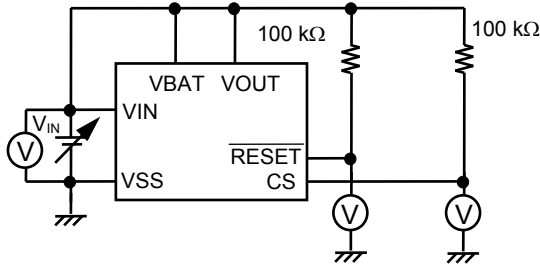

3.

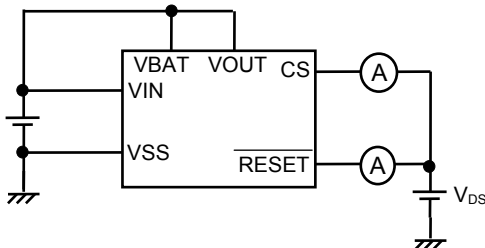

4.

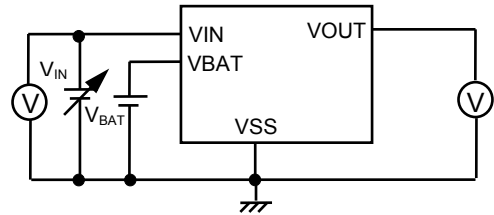

Measure the value after applying 6 V to VIN.

5.

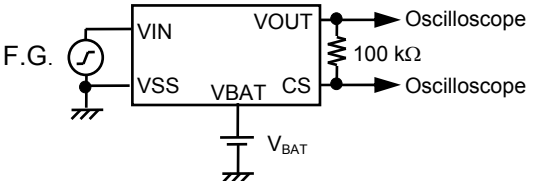

6.

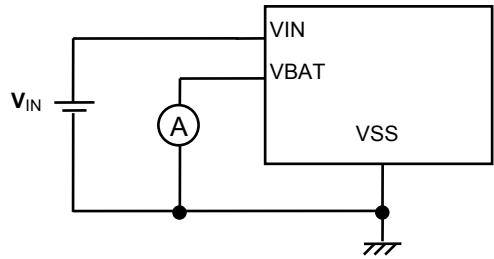

7.

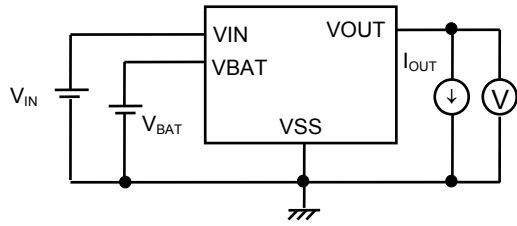

Leave open and measure the value after applying 6 V to VIN.

8.

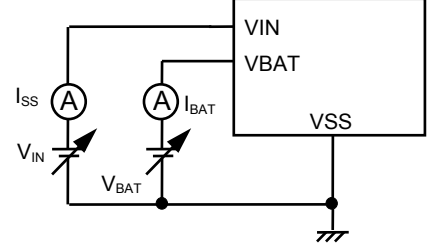

To measure I_{BAT2} , apply 6 V to VIN and then leave VIN open and measure I_{BAT} .

9.

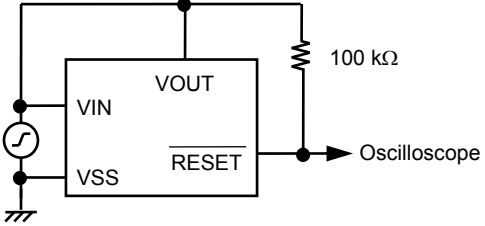
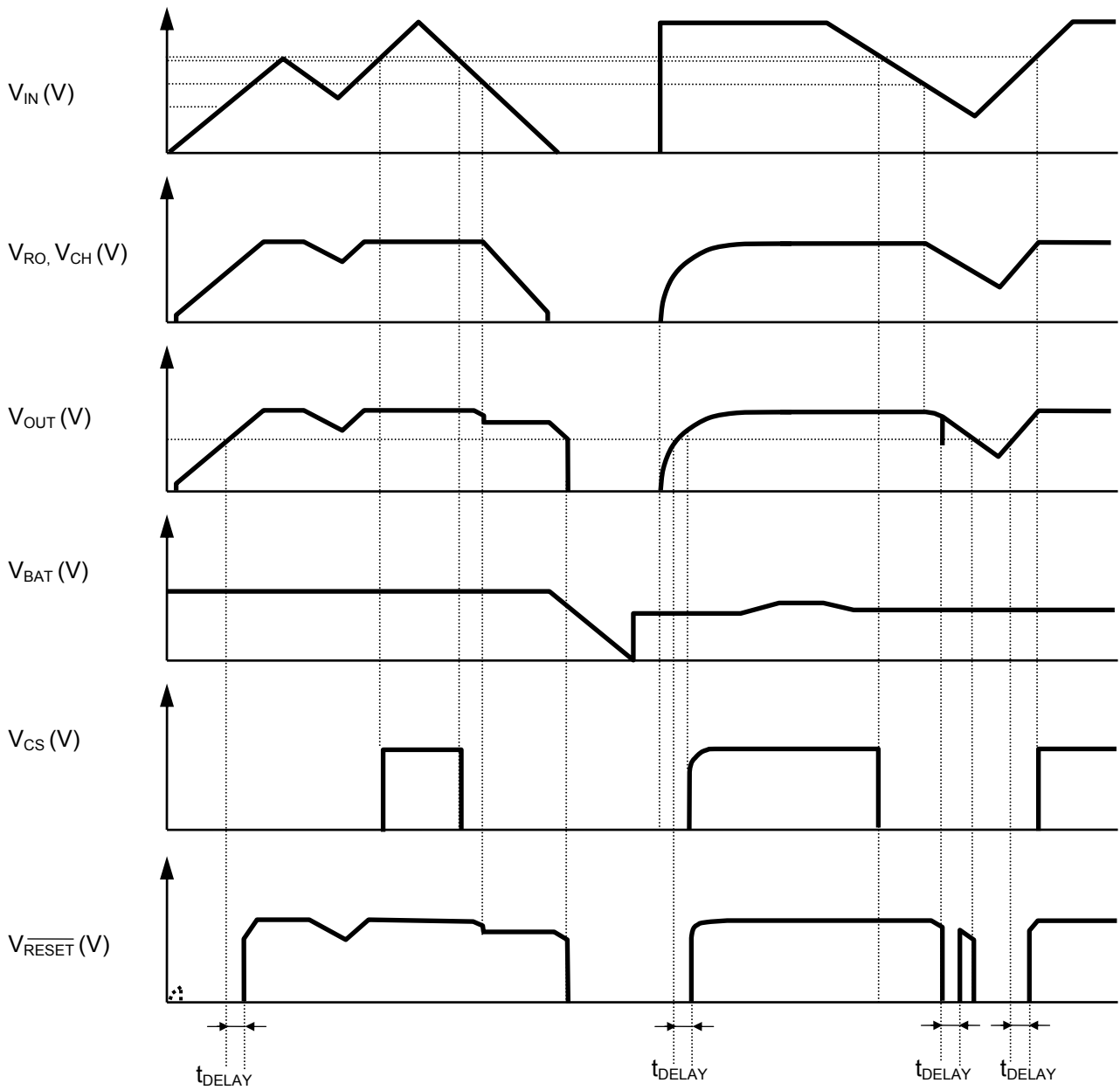

Figure 4 Test Circuits

■ **Timing Chart**



Remark CS and \overline{RESET} are pulled up to V_{OUT} . The Y-axis is an arbitrary scale.

Figure 5 Timing Chart

■ Operation

The internal configuration of the S-8425 Series is as follows.

- Voltage regulator 1, which stabilizes input voltage V_{IN} and outputs it to V_{RO}
- Voltage regulator 2, which stabilizes input voltage V_{IN} and outputs it to V_{OUT}
- Voltage regulator 3, which stabilizes input voltage V_{IN} and outputs it to V_{CH}
- CS voltage detector, which monitors input voltage V_{IN}
- \overline{RESET} voltage detector, which monitors output voltage V_{OUT}
- Switch unit

The functions and operations of the above-listed elements are described below.

1. Voltage Regulators

The S-8425 Series features on-chip voltage regulators with a small dropout voltage. The voltage of the VRO, VOUT, and VCH pins (the output pins of the voltage regulator) can separately be selected for the output voltage in 0.1 V steps between the range of 2.3 to 5.4 V.

[Dropout voltage V_{drop1} , V_{drop2} , V_{drop3}]

Assume that the voltage output from the VRO pin is $V_{RO(E)}$ under the conditions of output voltage 1 described in the electrical characteristics table. V_{IN1} is defined as the input voltage at which the output voltage from the VRO pin becomes 98% of $V_{RO(E)}$ when the input voltage V_{IN} is decreased. Then, the dropout voltage V_{drop1} is calculated by the following expression.

$$V_{drop1} = V_{IN1} - V_{RO(E)} \times 0.98$$

Similarly, assume that the voltage of the VOUT pin is $V_{OUT(E)}$, and $V_{CH(E)}$ respectively under the conditions of output voltage 2 and 3 described in the electrical characteristics table. V_{IN2} and V_{IN3} are defined as the input voltages at which the output voltage from the VOUT pin becomes 98% of $V_{OUT(E)}$ and $V_{CH(E)}$, respectively. Then, the dropout voltages V_{drop2} and V_{drop3} are calculated by the following expression.

$$V_{drop2} = V_{IN2} - V_{OUT(E)} \times 0.98$$

$$V_{drop3} = V_{IN3} - V_{CH(E)} \times 0.98$$

2. Voltage Detector

The S-8425 Series incorporates two high-precision, low power consuming voltage detectors with hysteresis characteristics. The power of the CS voltage detector is supplied from the VIN and VBAT pins. Therefore, the output is stable as long as the primary or backup power supply is within the operating voltage range (1.7 to 16 V). All outputs are Nch open-drain, and need pull-up resistors of about 100 k Ω .

2.1 CS Voltage Detector

The CS voltage detector monitors the input voltage V_{IN} (VIN pin voltage). The detection voltage can be selected from between 2.4 and 5.3 V in 0.1 V steps. The result of detection is output at the CS pin: "Low" for lower voltage than the detection level and "High" for higher voltage than the release level (however, when the VOUT pin voltage is the CS output inhibit voltage (V_{SW2}), a low level is output).

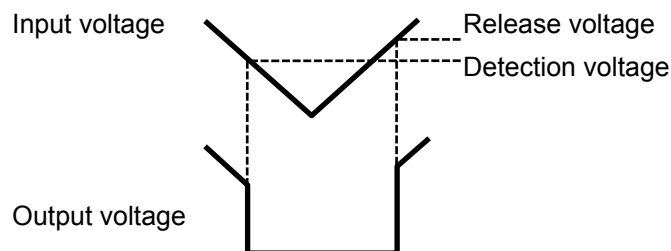

Figure 6 Definition of Detection and Release Voltages

2.2 $\overline{\text{RESET}}$ Voltage Detector

The $\overline{\text{RESET}}$ voltage detector monitors the output voltage V_{OUT} (V_{OUT} pin voltage). The detection voltage can be selected from between 1.7 V and 3.4 V in 0.1 V steps. The result of detection is output at the $\overline{\text{RESET}}$ pin: “Low” for a lower voltage than the detection level and “High” for a higher voltage than the release level. $\overline{\text{RESET}}$ outputs the normal logic if the V_{OUT} pin voltage is 1.0 V or more.

The S-8425 Series incorporates a $\overline{\text{RESET}}$ release delay circuit.

[$\overline{\text{RESET}}$ release delay time (t_{DELAY})]

The interval from when the V_{OUT} pin voltage exceeds the $\overline{\text{RESET}}$ release voltage value ($+V_{\text{DET2}}$) until the output of the $\overline{\text{RESET}}$ pin is actually inverted is called the $\overline{\text{RESET}}$ release delay time.



Figure 7 Definition of $\overline{\text{RESET}}$ Release Delay Time (t_{DELAY})

3. Switch Unit

The switch unit consists of the V_{SW1} and V_{SW2} detectors, a switch controller, voltage regulator 2, and switch transistor M1 (see **Figure 8 Switch Unit**).

3.1 V_{SW1} Detector

The V_{SW1} detector monitors the power supply voltage V_{IN} and sends the results of detection to the switch controller. The detection voltage (V_{SW1}) can be set to $77 \pm 2\%$ or $85 \pm 2\%$ of the CS release voltage $+V_{\text{DET1}}$.

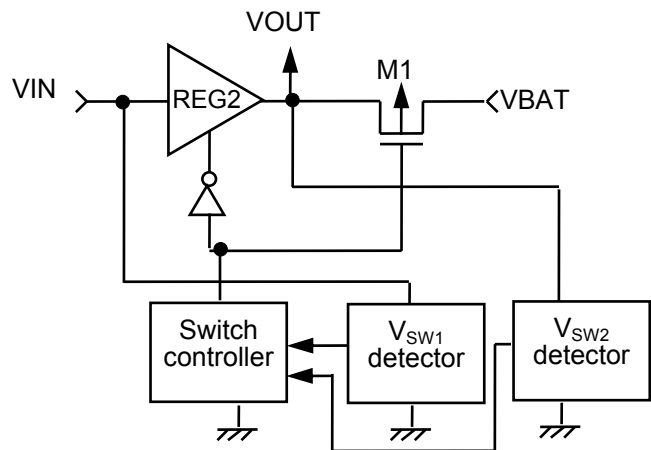

Figure 8 Switch Unit

3.2 V_{SW2} Detector

The V_{SW2} detector monitors the VOUT pin voltage and keeps the CS release voltage output low until the VOUT pin voltage rises to V_{SW2} voltage. The CS pin output then changes from low to high if the VIN pin voltage is more than the CS release voltage ($+V_{DET1}$) when the VOUT pin voltage rises to $95 \pm 2\%$ of the output voltage of voltage regulator 2 (V_{OUT}). The CS pin output changes from high to low regardless of the V_{SW2} voltage when the VIN pin voltage drops to less than the CS detection voltage ($-V_{DET1}$).

The CS pin output remains high if the VIN pin voltage stays higher than the CS detection voltage ($-V_{DET1}$) when the VOUT pin voltage drops to less than the V_{SW2} voltage due to an undershoot.

3.3 Switch Controller

The switch controller controls voltage regulator 2 and switch transistor M1. There are two statuses corresponding to the power supply voltage V_{IN} (or power supply voltage V_{BAT}) sequence: a special sequence status and a normal sequence status. When the power supply voltage V_{IN} rises and becomes equal to or exceeds the CS release voltage ($+V_{DET1}$), the normal sequence status is entered, but until then the special sequence status is maintained.

(1) Special sequence status

The switch controller sets voltage regulator 2 ON and switch transistor M1 OFF from the initial status until the primary power supply voltage V_{IN} is connected and reaches more than the CS release voltage ($+V_{DET1}$) in order to prevent consumption of the backup power supply regardless of the V_{SW1} detector status. This status is called the special sequence status.

(2) Normal sequence status

The switch controller enters the normal sequence status from the special sequence status once the primary power supply voltage V_{IN} reaches more than the CS release voltage ($+V_{DET1}$).

Once the normal sequence is entered, the switch controller switches voltage regulator 2 and switch transistor M1 ON/OFF as shown in Table 4 according to the power supply voltage V_{IN} . The time required for voltage regulator 2 to be switched from OFF to ON is a few hundred μs at most. During this interval, voltage regulator 2 and switch transistor M1 may both switch OFF and the VOUT pin voltage may drop. To prevent this, connect a capacitor of 10 μF or more to the VOUT pin.

When the VOUT pin voltage becomes lower than the RESET detection voltage, the status returns to the special sequence status.

**Table 4 ON/OFF Switching of Voltage Regulator 2 and Switch Transistor M1
According to Power Supply Voltage V_{IN}**

Power Supply Voltage V_{IN}	Voltage Regulator 2	Switch Transistor M1	VOUT Pin Voltage
$V_{IN} > V_{SW1}$	ON	OFF	V_{OUT}
$V_{IN} < V_{SW1}$	OFF	ON	$V_{BAT} - V_{dif}$

3.4 Switch Transistor M1

Voltage regulator 2 is also used to switch from the VIN pin to the VOUT pin. Therefore, no reverse current flows from the VOUT pin to the VIN pin when voltage regulator 2 is OFF.

The output voltage of voltage regulator 2 can be selected from between 2.3 V and 5.4 V in 0.1 V steps.

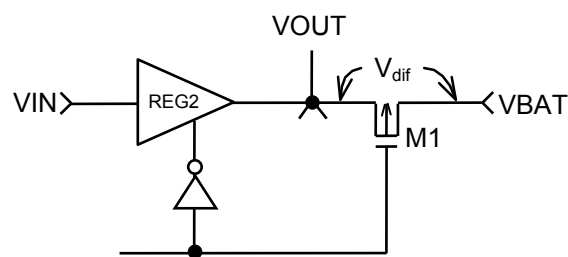

Figure 9 Definition of V_{dif}

The on-resistance of switch transistor M1 is 60 Ω or lower ($I_{OUT} = 10$ to $500 \mu A$).

Therefore, when M1 is switched ON and the VOUT pin is connected to the VBAT pin, the voltage drop V_{dif} caused by M1 is $60 \times I_{OUT}$ (output current) at maximum, and $V_{BAT} - V_{dif}(\text{max.})$ is output to the VOUT pin at minimum.

When voltage regulator 2 is ON and M1 is OFF, the leakage current of M1 is kept below $0.1 \mu A$ max. ($V_{IN} = 6 V$, $T_a = 25^\circ C$) with the VBAT pin grounded (VSS pin).

■ Transient Response

1. Line Transient Response Against Input Voltage Variation

The input voltage variation differs depending on whether the power supply input (0 V→10 V square wave) is applied or the power supply variation (6 V↔10 V square waves) is applied. This section describes the ringing waveforms and parameter dependency of each type. The test circuit is shown for reference.

Power supply application: 0 V→10 V square wave



Figure 10 Power Supply Application: 0 V→10 V Square Wave

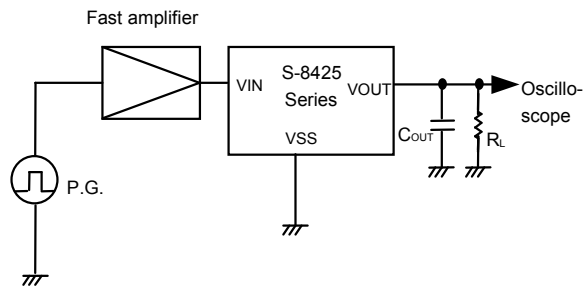

Figure 11 Test Circuit

Power Supply Application

VOUT pin

$C_{OUT} = 22 \mu F, I_{OUT} = 50 \text{ mA}, T_a = 25^\circ C$



Figure 12 Ringing Waveform of Power Supply Application (VOUT Pin)

VRO pin

$C_{RO} = 22 \mu F, I_{RO} = 30 \text{ mA}, T_a = 25^\circ C$

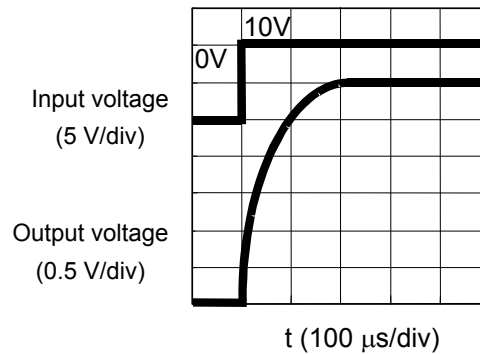

Figure 13 Ringing Waveform of Power Supply Application (VRO Pin)

VCH pin

$C_{CH} = 10 \mu F, I_{CH} = 10 \text{ mA}, T_a = 25^\circ C$



Figure 14 Ringing Waveform of Power Supply Application (VCH Pin)

Power supply variation: 6 V↔10 V square waves

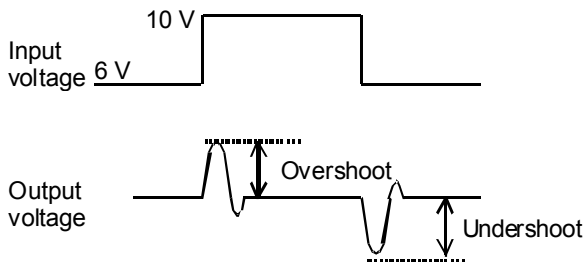

**Figure 15 Power Supply Variation:
6 V↔10 V Square Waves**



Figure 16 Test Circuit

Power Supply Variation

VOUT pin



Figure 17 Ringing Waveform of Power Supply Variation (VOUT Pin)

VRO pin



Figure 18 Ringing Waveform of Power Supply Variation (VRO Pin)

VCH pin

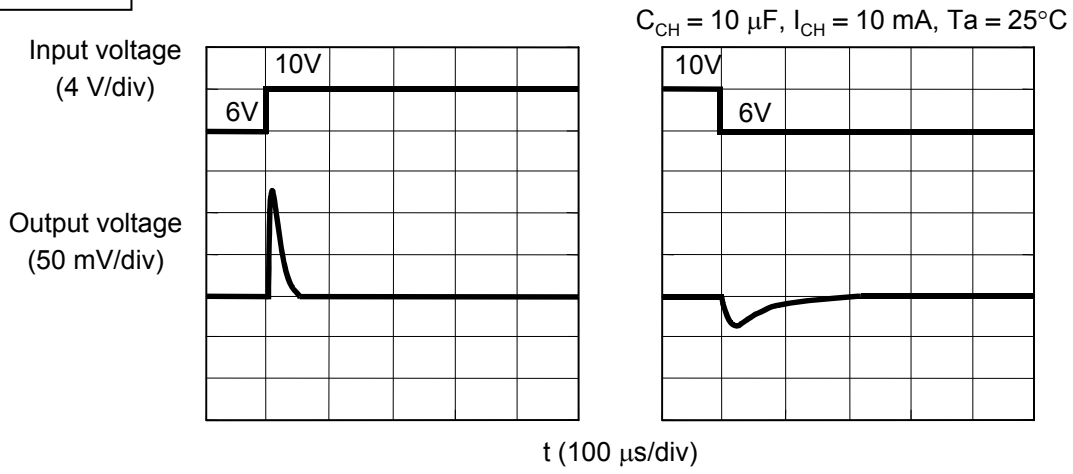

Figure 19 Ringing Waveform of Power Supply Variation (VCH Pin)

**Reference data: Dependency of output current (I_{OUT}), load capacitance (C_{OUT}),
input variation width (ΔV_{IN}), temperature (T_a)**

For reference, the following pages describe the results of measuring the ringing amounts at the VOUT and VRO pins using the output current (I_{OUT}), load capacitance (C_{OUT}), input variation width (ΔV_{IN}), and temperature (T_a) as parameters.

1.1 I_{OUT} Dependency

(1) VOUT pin

$C_{OUT} = 22 \mu F$, $V_{IN} = 6 V \leftrightarrow 10 V$, $T_a = 25^\circ C$

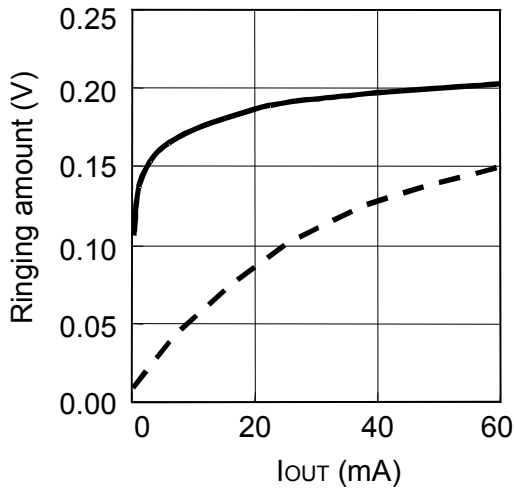

(2) VRO pin

$C_{RO} = 22 \mu F$, $V_{IN} = 6 V \leftrightarrow 10 V$, $T_a = 25^\circ C$

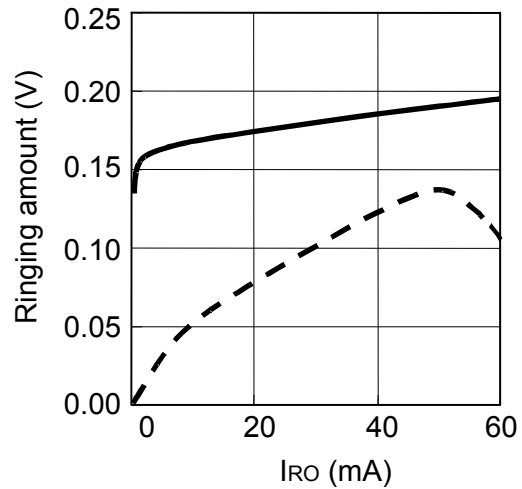

(3) VCH pin

$C_{CH} = 10 \mu F$, $V_{IN} = 6 V \leftrightarrow 10 V$, $T_a = 25^\circ C$

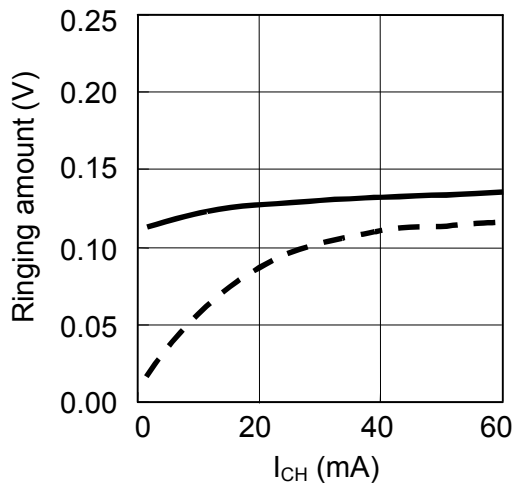

— Overshoot
- - - Undershoot

1.2 C_{OUT} Dependency

(1) V_{OUT} pin

I_{OUT} = 50 mA, V_{IN} = 6 V↔10 V, Ta = 25°C

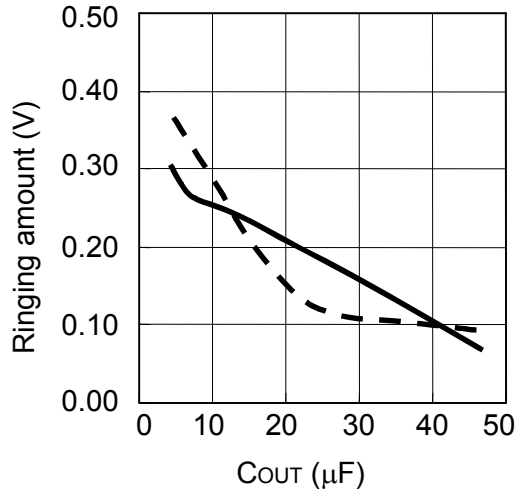

(2) V_{RO} pin

I_{RO} = 30 mA, V_{IN} = 6 V↔10 V, Ta = 25°C

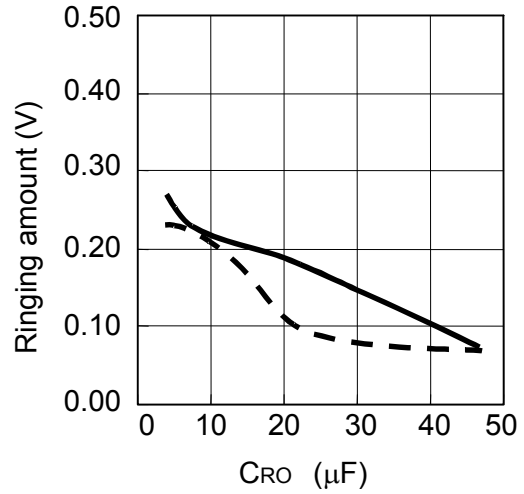

(3) V_{CH} pin

I_{CH} = 10 mA, V_{IN} = 6 V↔10 V, Ta = 25°C

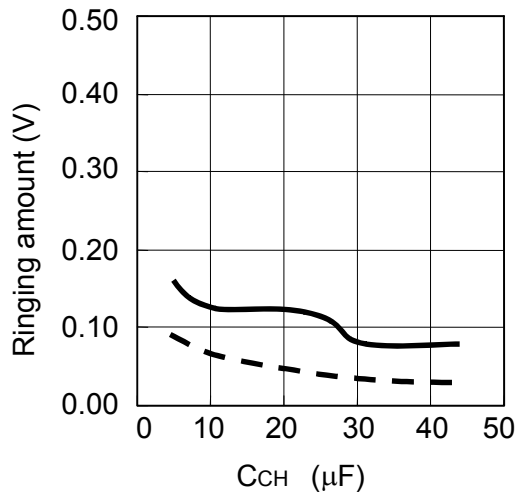

— Overshoot
- - - Undershoot

1.3 ΔV_{IN} Dependency

ΔV_{IN} shows the difference between the low voltage fixed to 6 V and the high voltage.

For example, $\Delta V_{IN} = 2$ V means the difference between 6 V and 8 V.

(1) VOUT pin

$I_{OUT} = 50$ mA, $C_{OUT} = 22$ μ F, $T_a = 25^\circ$ C

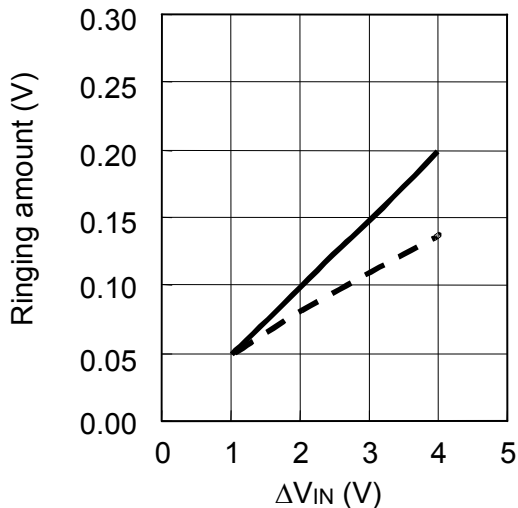

(2) VRO pin

$I_{RO} = 30$ mA, $C_{RO} = 22$ μ F, $T_a = 25^\circ$ C

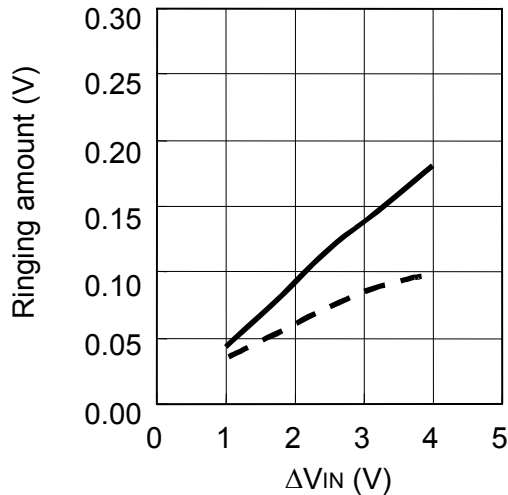

(3) VCH pin

$I_{CH} = 10$ mA, $C_{CH} = 10$ μ F, $T_a = 25^\circ$ C

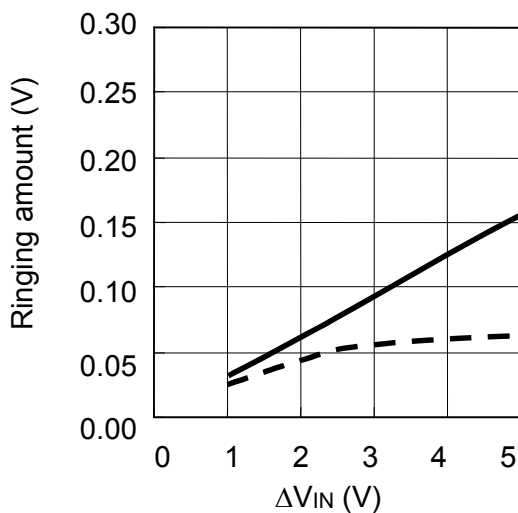

— Overshoot
 - - - Undershoot

1.4 Temperature Dependency

(1) VOUT pin

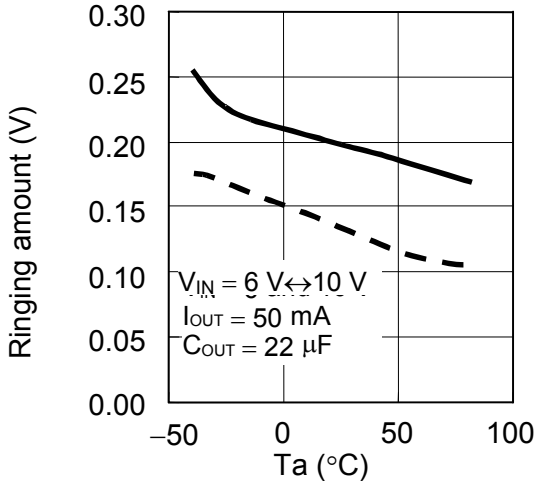

(2) VRO pin

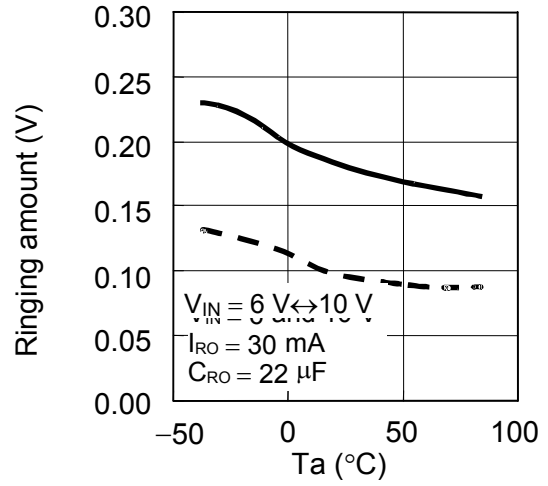

(3) VCH pin

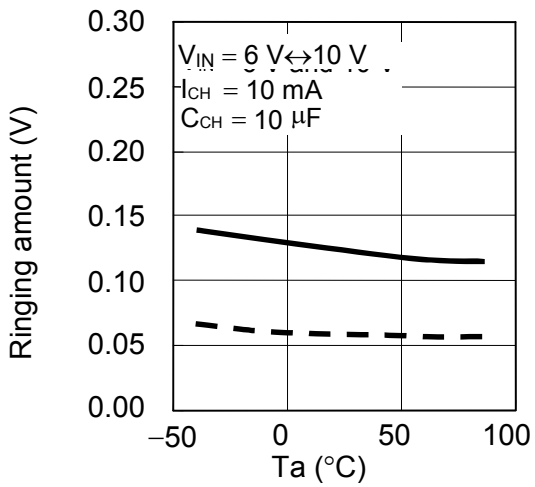

Overshoot
 Undershoot

2. Load Transient Response Based on Output Current Fluctuation

The overshoot and undershoot are caused in the output voltage if the output current fluctuates between 10 μ A and 50 mA (V_{RO} is between 10 μ A and 30 mA, V_{CH} is between 10 μ A and 10 mA) while the input voltage is constant. Figure 20 shows the output voltage variation due to the output current. Figure 21 shows the test circuit for reference. The latter half of this section describes ringing waveform and parameter dependency.

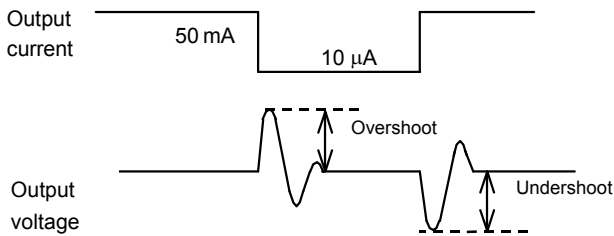

Figure 20 Output Voltage Variation due to Output Current

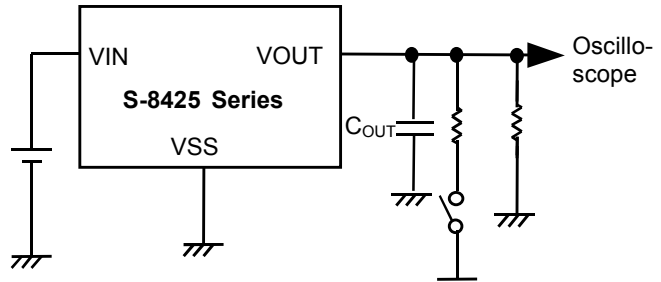

Figure 21 Test Circuit

Figures 22 to 24 show the ringing waveforms at the VOUT, VRO, and VCH pins due to the load variation.

VOUT pin

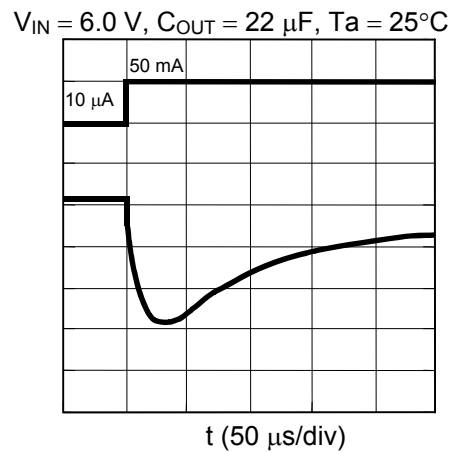
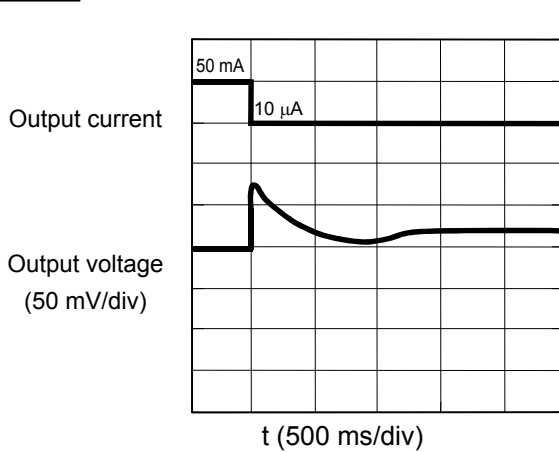

Figure 22 Ringing Waveform due to Load Variation (VOUT Pin)

VRO pin

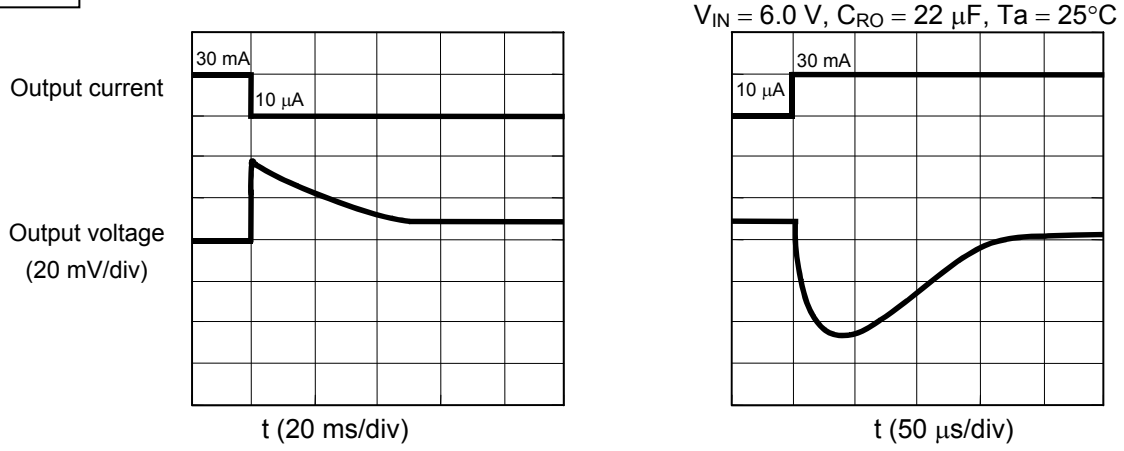

Figure 23 Ringing Waveform due to Load Variation (VRO Pin)

VCH pin

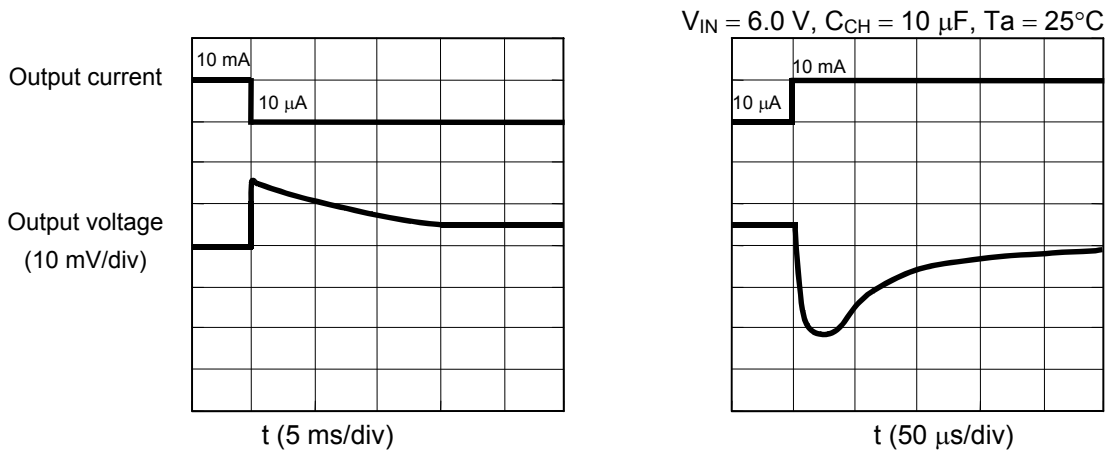

Figure 24 Ringing Waveform due to Load Variation (VCH Pin)

Reference data: Dependency of input voltage (V_{IN}), load capacitance (C_{OUT}), output variation width (ΔI_{OUT}), temperature (T_a)

2.1 V_{IN} Dependency

(1) V_{OUT} pin

$C_{OUT} = 22 \mu F$, $I_{OUT} = 50 \text{ mA} \leftrightarrow 10 \mu A$, $T_a = 25^\circ C$



(2) V_{RO} pin

$C_{RO} = 22 \mu F$, $I_{RO} = 30 \text{ mA} \leftrightarrow 10 \mu A$, $T_a = 25^\circ C$



(3) V_{CH} pin

$C_{CH} = 10 \mu F$, $I_{CH} = 10 \text{ mA} \leftrightarrow 10 \mu A$, $T_a = 25^\circ C$

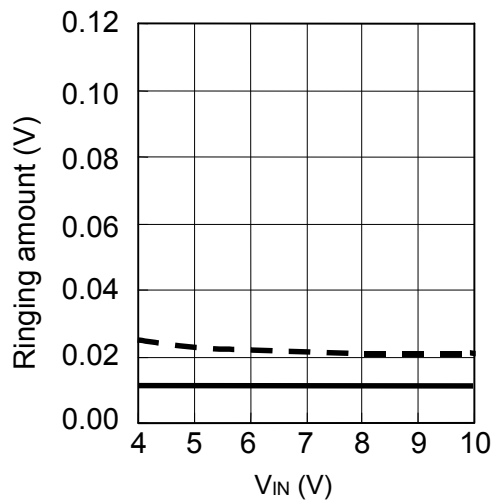

— Overshoot
 - - - Undershoot

2.2 C_{OUT} Dependency

(1) V_{OUT} pin

V_{IN} = 6.0 V, I_{OUT} = 50 mA ↔ 10 μA, Ta = 25°C

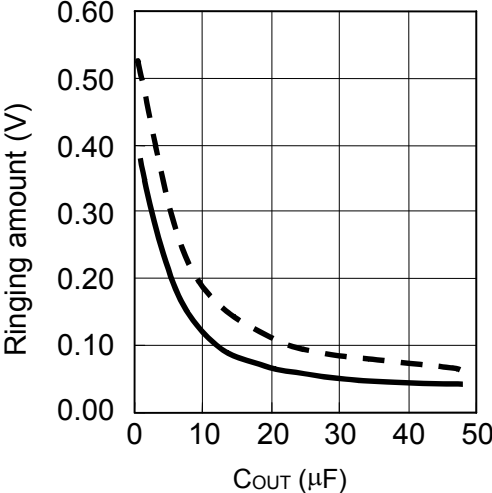

(2) V_{RO} pin

V_{IN} = 6.0 V, I_{RO} = 30 mA ↔ 10 μA, Ta = 25°C

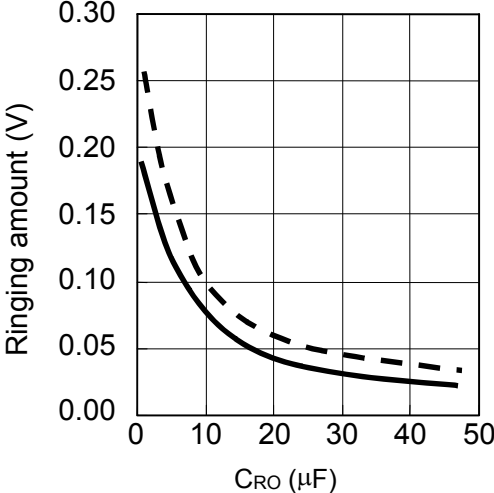

(3) V_{CH} pin

C_{CH} = 10 μF, I_{CH} = 10 mA ↔ 10 μA, Ta = 25°C

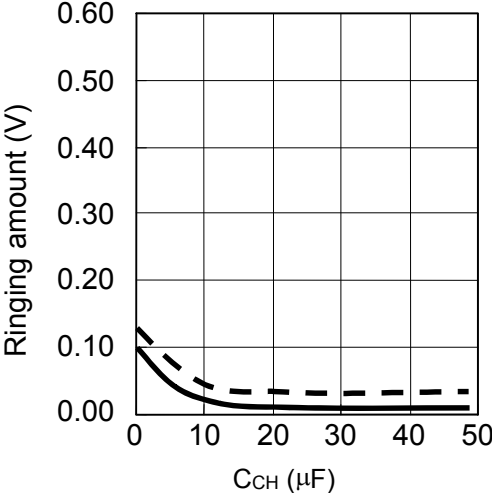

— Overshoot
- - - Undershoot

2.3 ΔI_{OUT} Dependency

ΔI_{OUT} and ΔI_{RO} show the fluctuation between the low current stabilized at 10 μA and the high current. For example, $\Delta I_{OUT} = 10$ mA means a fluctuation between 10 μA and 10 mA.

(1) VOUT pin

$C_{OUT} = 22 \mu F$, $V_{IN} = 6$ V, $T_a = 25^\circ C$



(2) VRO pin

$C_{RO} = 22 \mu F$, $V_{IN} = 6$ V, $T_a = 25^\circ C$

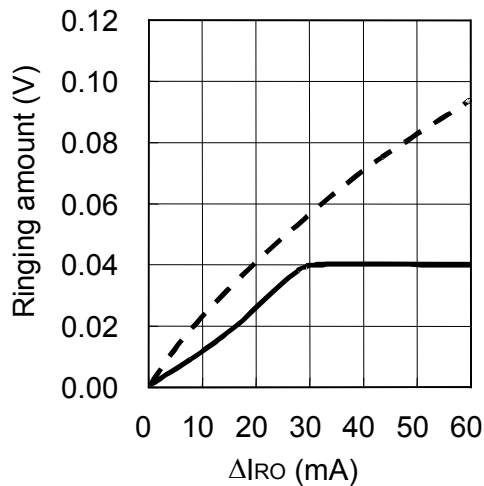

(3) VCH pin

$C_{CH} = 10 \mu F$, $V_{IN} = 6$ V, $T_a = 25^\circ C$

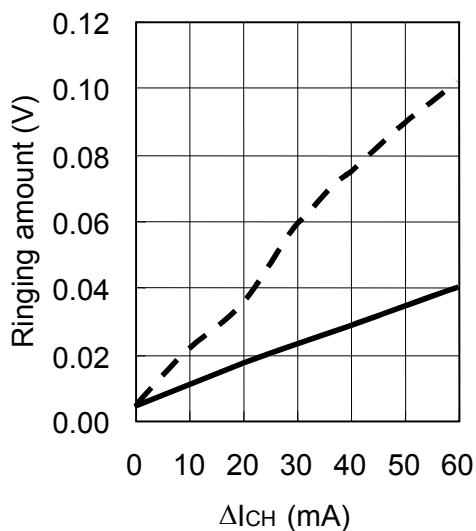

— Overshoot
 - - - Undershoot

2.4 Temperature Dependency

(1) VOUT pin

$V_{IN} = 6.0\text{ V}$, $I_{OUT} = 50\ \mu\text{A} \leftrightarrow 10\ \mu\text{A}$, $C_{OUT} = 22\ \mu\text{F}$

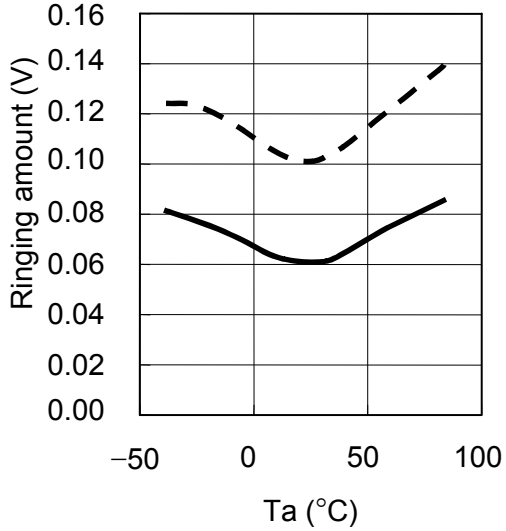

(2) VRO pin

$V_{IN} = 6.0\text{ V}$, $I_{RO} = 30\ \text{mA} \leftrightarrow 10\ \mu\text{A}$, $C_{RO} = 22\ \mu\text{F}$

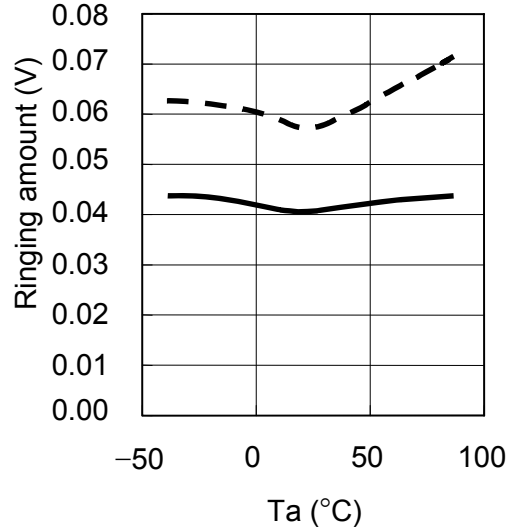

(3) VCH pin

$V_{IN} = 6\text{ V}$, $I_{CH} = 10\ \text{mA} \leftrightarrow 10\ \mu\text{A}$, $C_{CH} = 10\ \mu\text{F}$

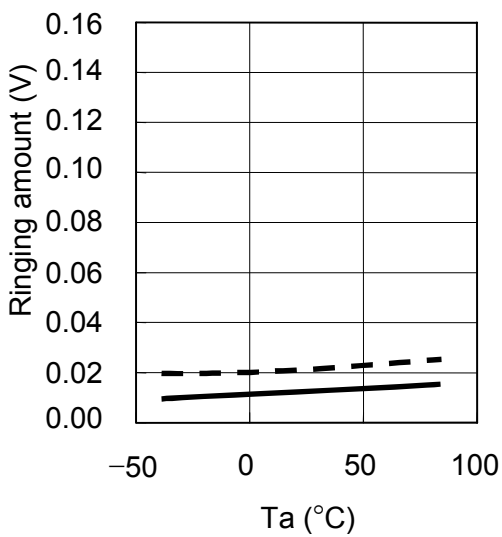

— Overshoot
- - - Undershoot

■ Standard Circuit



Figure 25 Standard Circuit

- Caution**
- Be sure to add a 10 μF or more capacitor to the VOUT, VRO, and VCH pins.
 - The above connection diagram and constant will not guarantee successful operation. Perform thorough evaluation using the actual application to set the constant.

■ Precautions

- In applications in which any one of I_{RO} , I_{OUT} , or I_{CH} is small, the output voltages V_{RO} , V_{OUT} , and V_{CH} may rise, causing the load stability to exceed standard levels. Set I_{RO} , I_{OUT} , or I_{CH} to 10 μA or more.
- Attach the proper capacitor to the VOUT pin to prevent the $\overline{\text{RESET}}$ voltage detector (which monitors the VOUT pin) from becoming active due to undershoot.
- Watch for overshoot and ensure it does not exceed the ratings of the IC chips and/or capacitors attached to the VRO, VOUT, and VCH pins.
- Add a 10 μF or more capacitor to the VOUT, VRO, and VCH pins.
- Do not apply an electrostatic discharge to this IC that exceeds the performance ratings of the built-in electrostatic protection circuit.
- ABLIC Inc. claims no responsibility for any and all disputes arising out of or in connection with any infringement by products including this IC of patents owned by a third party.

■ Application Circuit

When Using Secondary Battery as Backup Battery

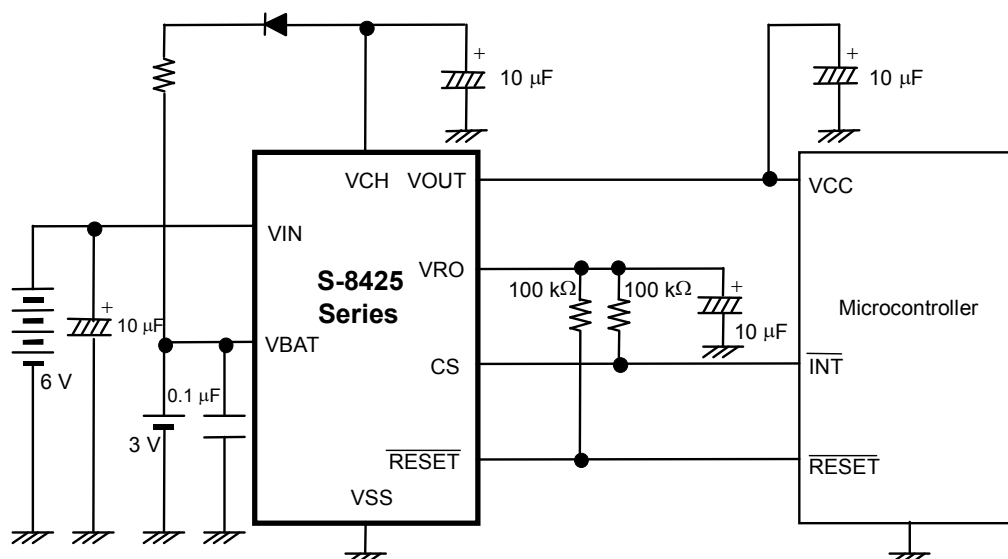

Caution The above connection diagram and constant will not guarantee successful operation. Perform thorough evaluation using the actual application to set the constant.

Remark The backup battery can be floating-recharged by using voltage regulator 3.

Figure 26 Application Circuit

■ **Characteristics**

1. Voltage Regulator Unit

1.1 Input Voltage (V_{IN}) vs. Output Voltage (V_{RO}) Characteristics (REG1) ($V_{RO} = 3.0\text{ V}$)

(1) $T_a = 85^\circ\text{C}$

$I_{RO} = 10\text{ mA}, 30\text{ mA}, 50\text{ mA}, 70\text{ mA}, 90\text{ mA}$



(2) $T_a = 25^\circ\text{C}$

$I_{RO} = 10\text{ mA}, 30\text{ mA}, 50\text{ mA}, 70\text{ mA}, 90\text{ mA}$

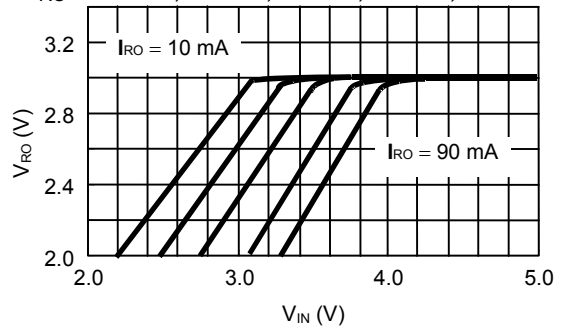

(3) $T_a = -40^\circ\text{C}$

$I_{RO} = 10\text{ mA}, 30\text{ mA}, 50\text{ mA}, 70\text{ mA}, 90\text{ mA}$

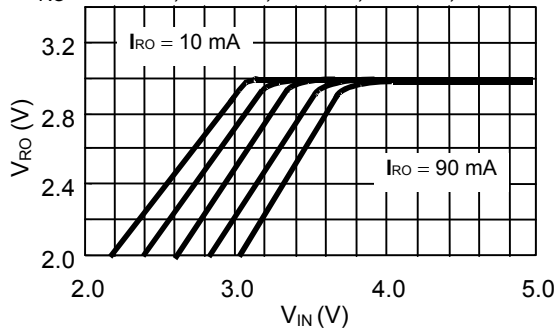

1.2 Input Voltage (V_{IN}) vs. Output Voltage (V_{OUT}) Characteristics (REG2) ($V_{OUT} = 3.0\text{ V}$)

(1) $T_a = 85^\circ\text{C}$

$I_{OUT} = 10\text{ mA}, 30\text{ mA}, 50\text{ mA}, 70\text{ mA}, 90\text{ mA}$

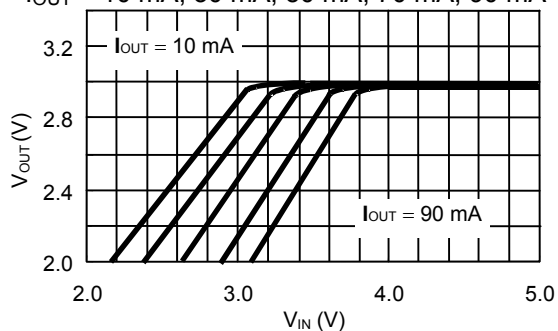

(2) $T_a = 25^\circ\text{C}$

$I_{OUT} = 10\text{ mA}, 30\text{ mA}, 50\text{ mA}, 70\text{ mA}, 90\text{ mA}$

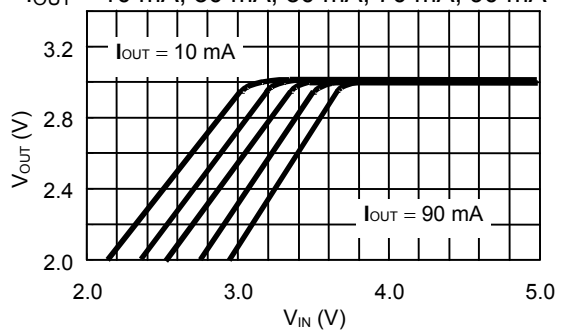

(3) $T_a = -40^\circ\text{C}$

$I_{OUT} = 10\text{ mA}, 30\text{ mA}, 50\text{ mA}, 70\text{ mA}, 90\text{ mA}$

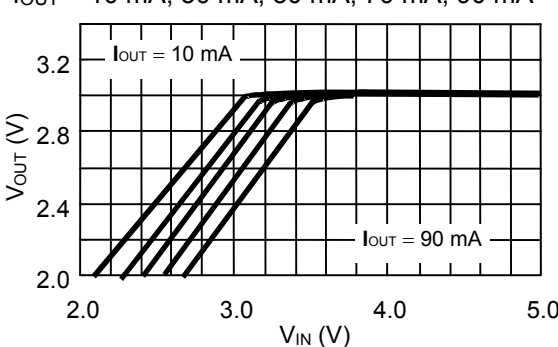

1.3 Input Voltage (V_{IN}) vs. Output Voltage (V_{OUT}) Characteristics (REG3) ($V_{CH} = 3.3\text{ V}$)

(1) $T_a = 85^\circ\text{C}$

(2) $T_a = 25^\circ\text{C}$

$I_{RO} = 10\text{ mA}, 30\text{ mA}, 50\text{ mA}, 70\text{ mA}$

$I_{RO} = 10\text{ mA}, 30\text{ mA}, 50\text{ mA}, 70\text{ mA}$

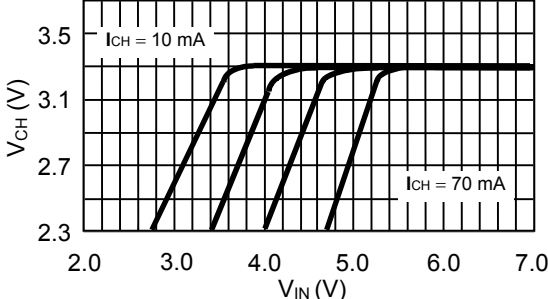
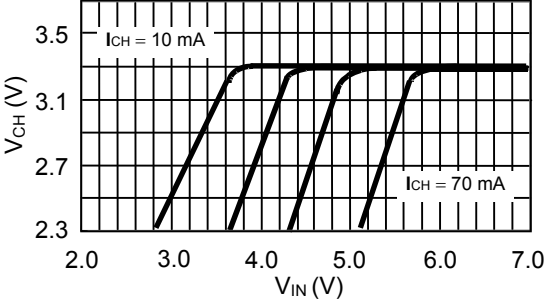

(3) $T_a = -40^\circ\text{C}$

$I_{RO} = 10\text{ mA}, 30\text{ mA}, 50\text{ mA}, 70\text{ mA}$

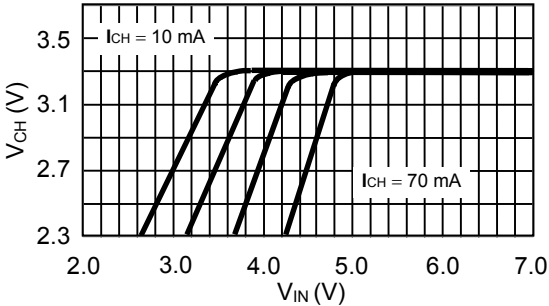

1.4 Output Current (I_{RO}) vs. Dropout Voltage (V_{drop1}) Characteristics

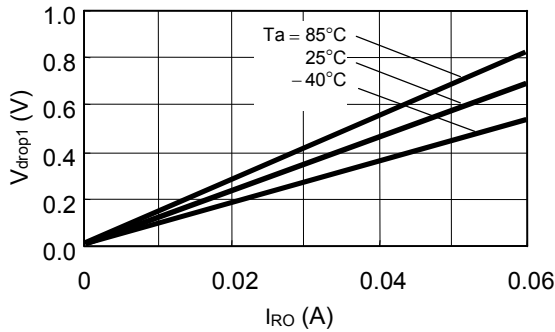

1.5 Output Current (I_{OUT}) vs. Dropout Voltage (V_{drop2}) Characteristics

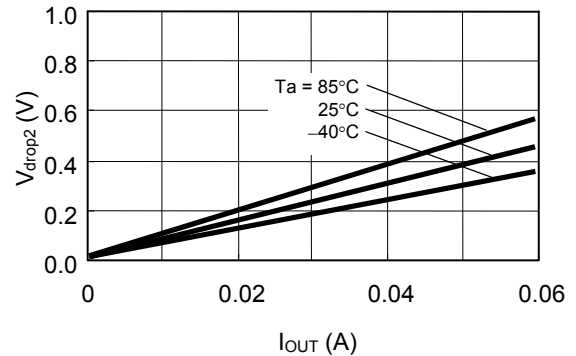

1.6 Output Current (I_{CH}) vs. Dropout Voltage (V_{drop3}) Characteristics



1.7 Output Current (I_{RO}) vs. Output Voltage (V_{RO}) Characteristics

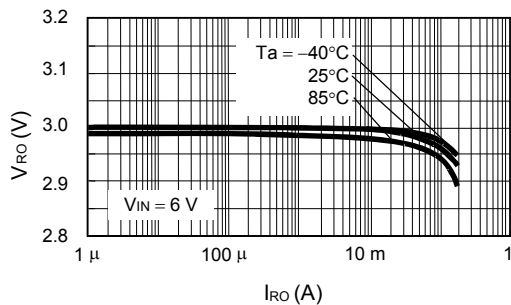

1.8 Output Current (I_{OUT}) vs. Output Voltage (V_{OUT}) Characteristics

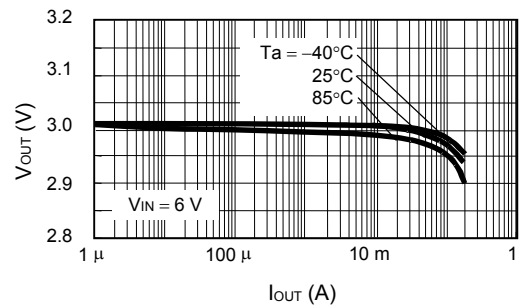

1.9 Output Current (I_{OUT}) vs. Output Voltage (V_{CH}) Characteristics

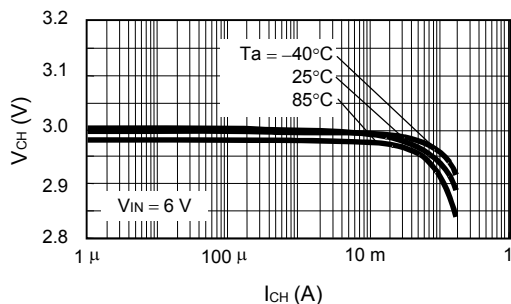

1.10 Output Voltage (V_{RO}) Temperature Characteristics

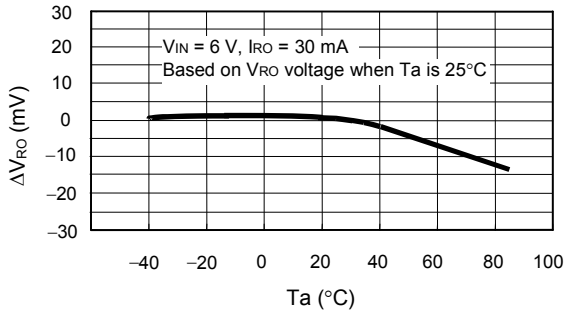

1.11 Output Voltage (V_{OUT}) Temperature Characteristics

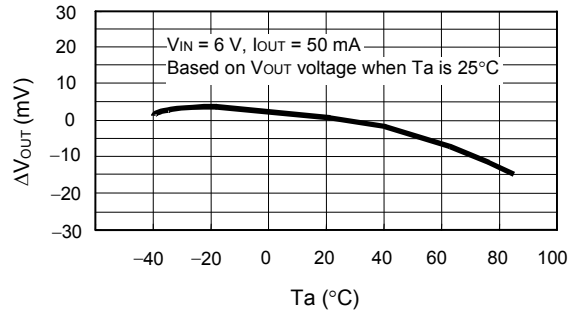

1.12 Output Voltage (V_{CH}) Temperature Characteristics

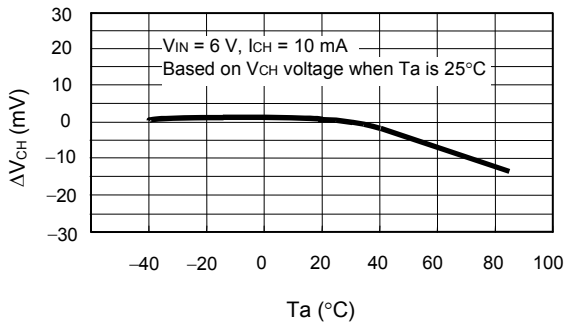

1.13 Input Stability (ΔV_{RO2}) Temperature Characteristics

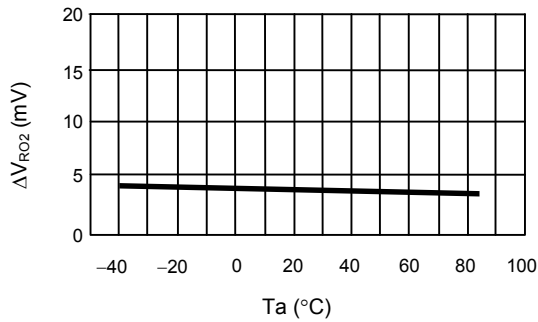

1.14 Input Stability (ΔV_{OUT2}) Temperature Characteristics

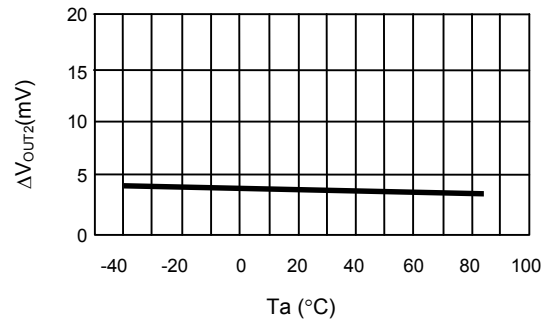

1.15 Input Stability (ΔV_{CH2}) Temperature Characteristics



1.16 Load Stability (ΔV_{RO1}) Temperature Characteristics



1.17 Load Stability (ΔV_{OUT1}) Temperature Characteristics



1.18 Load Stability (ΔV_{CH1}) Temperature Characteristics



2. Voltage Detector

2.1 CS Voltage Detector ($-V_{DET1} = 3.3\text{ V}$)

(1) Detection voltage ($-V_{DET1}$) temperature characteristics

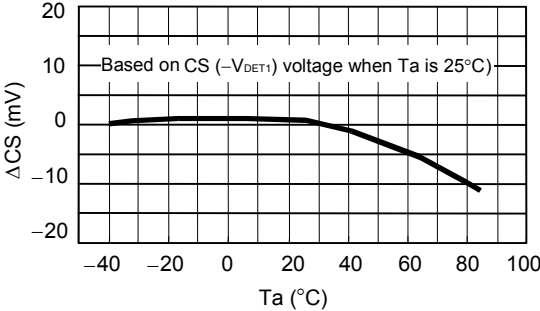

(2) Output current (I_{SINK}) characteristics

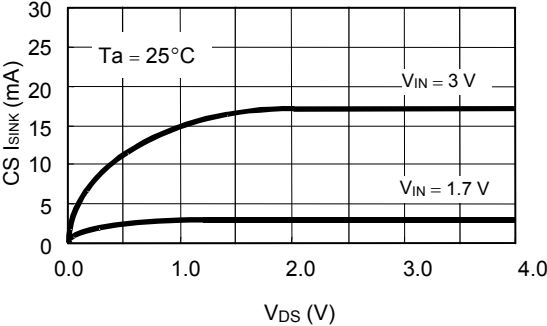

(3) Output current (I_{SINK}) temperature characteristics

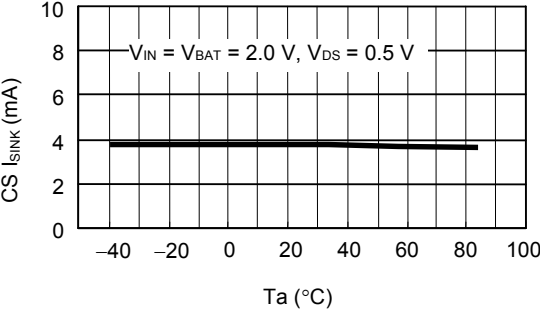

2.2 RESET Voltage Detector ($-V_{DET2} = 2.4\text{ V}$)

(1) Detection voltage ($-V_{DET2}$) temperature characteristics

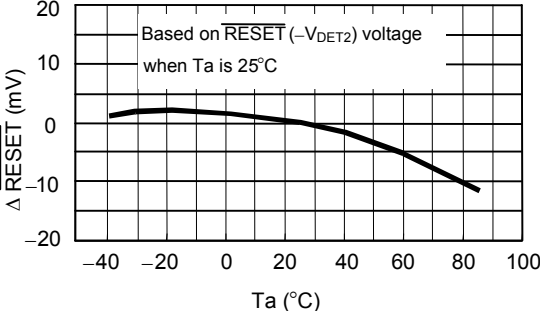

(2) Output current (I_{SINK}) characteristics

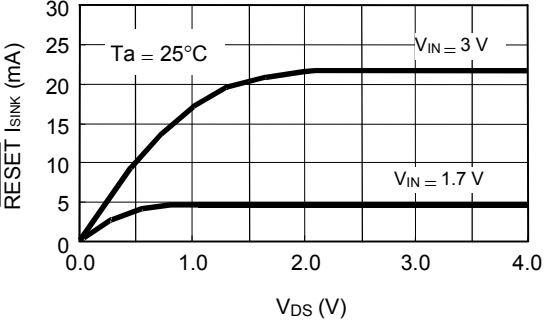

(3) Output current (I_{SINK}) temperature characteristics

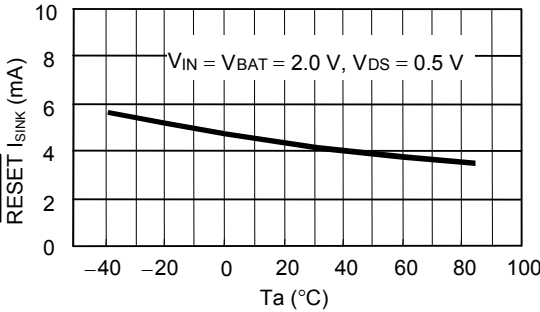

(4) RESET release delay time

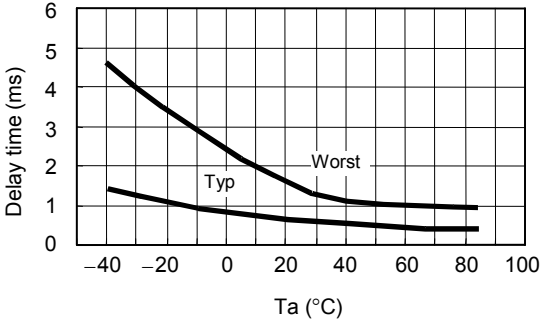

3. Switch Unit

3.1 Switch Voltage (V_{SW1}) Temperature Characteristics

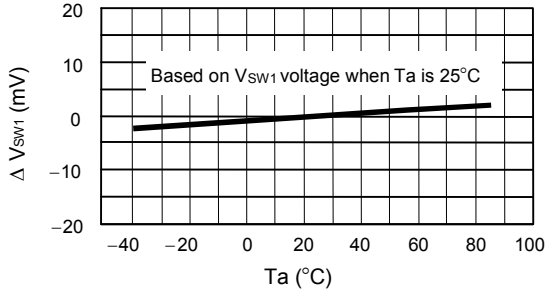

3.2 CS Output Inhibit Voltage (V_{SW2}) Temperature Characteristics



3.3 Input Voltage (V_{BAT}) vs. V_{BAT} Switch Resistance (R_{SW}) Characteristics

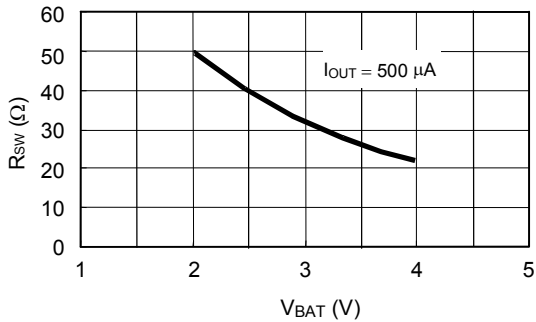

3.4 V_{BAT} Switch Resistance (R_{SW}) Temperature Characteristics



3.5 V_{BAT} Switch Leakage Current (I_{LEAK}) Temperature Characteristics

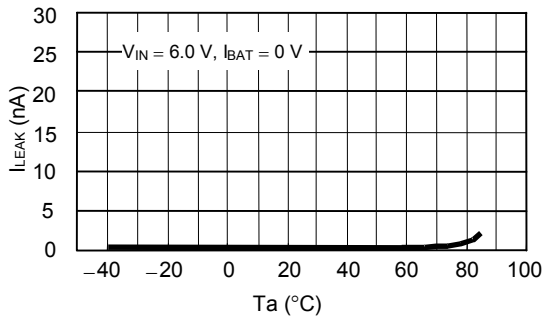

4. Current Consumption

4.1 V_{IN} vs. I_{SS1} Current Consumption (I_{SS1}) Characteristics

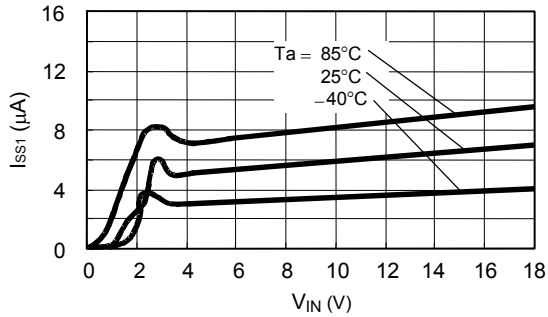

4.2 V_{BAT} vs. I_{BAT2} Current Consumption (I_{BAT2}) Characteristics

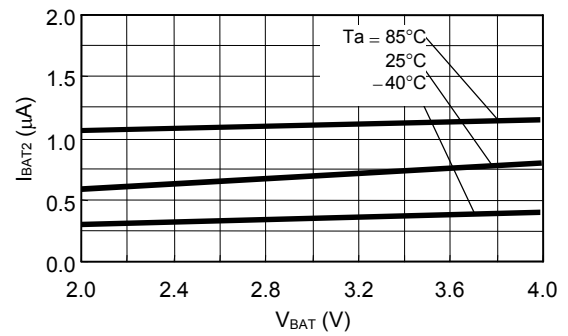

4.3 Current Consumption Temperature Characteristics

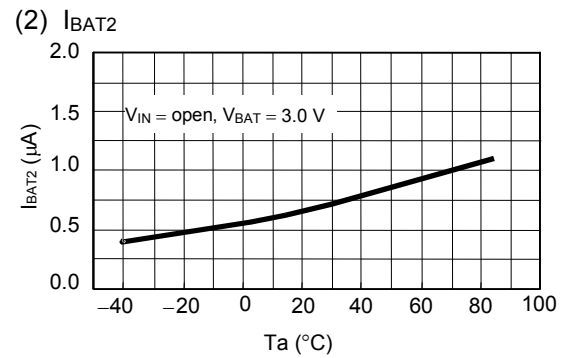
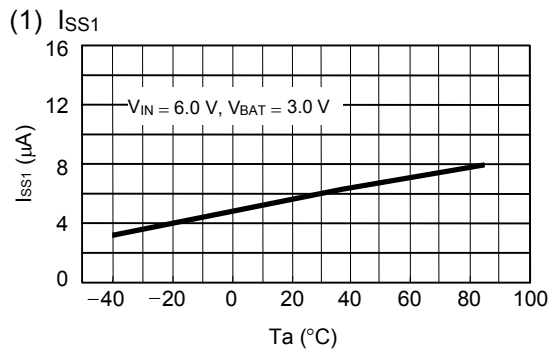

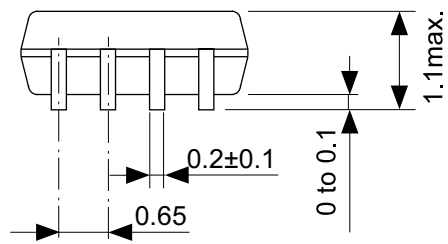
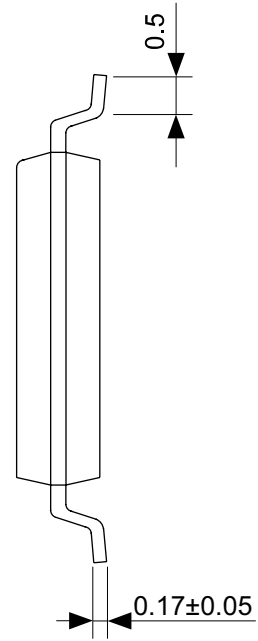

No. FT008-A-P-SD-1.2

TITLE	TSSOP8-E-PKG Dimensions
No.	FT008-A-P-SD-1.2
ANGLE	
UNIT	mm
ABLIC Inc.	

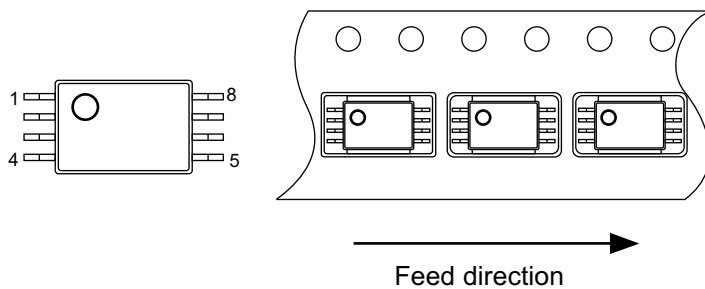
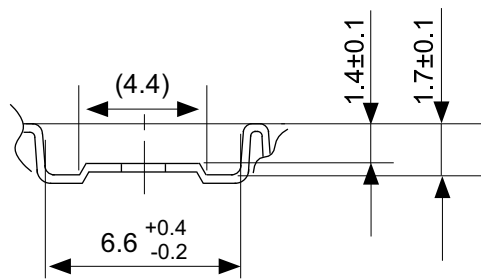

No. FT008-E-C-SD-1.0

TITLE	TSSOP8-E-Carrier Tape
No.	FT008-E-C-SD-1.0
ANGLE	
UNIT	mm
ABLIC Inc.	



Enlarged drawing in the central part



No. FT008-E-R-SD-1.0

TITLE	TSSOP8-E-Reel		
No.	FT008-E-R-SD-1.0		
ANGLE		QTY.	3,000
UNIT	mm		
ABLIC Inc.			



Enlarged drawing in the central part



No. FT008-E-R-S1-1.0

TITLE	TSSOP8-E-Reel		
No.	FT008-E-R-S1-1.0		
ANGLE		QTY.	4,000
UNIT	mm		
ABLIC Inc.			

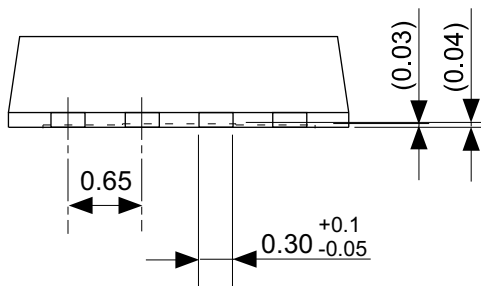
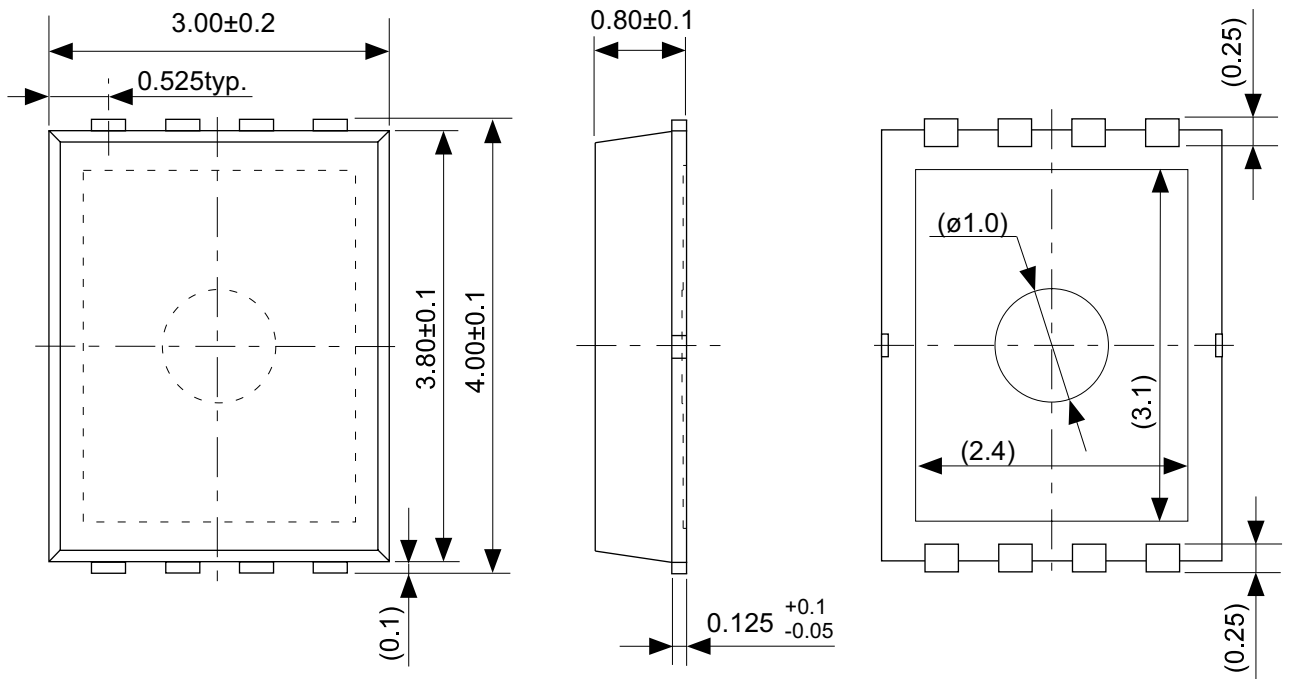

No. PA008-B-P-SD-4.0

TITLE	SON8B-B-PKG Dimensions
No.	PA008-B-P-SD-4.0
ANGLE	
UNIT	mm
ABLIC Inc.	

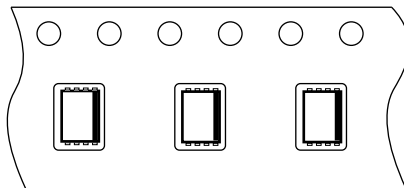

→
Feed direction

No. PA008-B-C-SD-1.1

TITLE	SON8B-B-Carrier Tape
No.	PA008-B-C-SD-1.1
ANGLE	
UNIT	mm
ABLIC Inc.	



Enlarged drawing in the central part

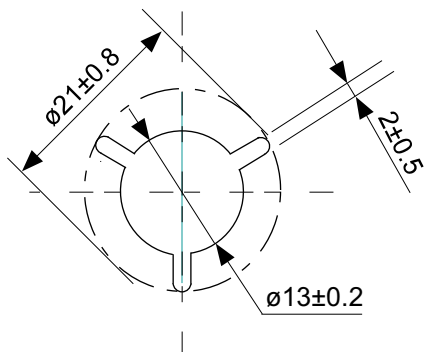

No. PA008-B-R-SD-1.1

TITLE	SON8B-B-Reel		
No.	PA008-B-R-SD-1.1		
ANGLE		QTY.	3,000
UNIT	mm		
ABLIC Inc.			

Disclaimers (Handling Precautions)

1. All the information described herein (product data, specifications, figures, tables, programs, algorithms and application circuit examples, etc.) is current as of publishing date of this document and is subject to change without notice.
2. The circuit examples and the usages described herein are for reference only, and do not guarantee the success of any specific mass-production design.
ABLIC Inc. is not responsible for damages caused by the reasons other than the products described herein (hereinafter "the products") or infringement of third-party intellectual property right and any other right due to the use of the information described herein.
3. ABLIC Inc. is not responsible for damages caused by the incorrect information described herein.
4. Be careful to use the products within their specified ranges. Pay special attention to the absolute maximum ratings, operation voltage range and electrical characteristics, etc.
ABLIC Inc. is not responsible for damages caused by failures and / or accidents, etc. that occur due to the use of the products outside their specified ranges.
5. When using the products, confirm their applications, and the laws and regulations of the region or country where they are used and verify suitability, safety and other factors for the intended use.
6. When exporting the products, comply with the Foreign Exchange and Foreign Trade Act and all other export-related laws, and follow the required procedures.
7. The products must not be used or provided (exported) for the purposes of the development of weapons of mass destruction or military use. ABLIC Inc. is not responsible for any provision (export) to those whose purpose is to develop, manufacture, use or store nuclear, biological or chemical weapons, missiles, or other military use.
8. The products are not designed to be used as part of any device or equipment that may affect the human body, human life, or assets (such as medical equipment, disaster prevention systems, security systems, combustion control systems, infrastructure control systems, vehicle equipment, traffic systems, in-vehicle equipment, aviation equipment, aerospace equipment, and nuclear-related equipment), excluding when specified for in-vehicle use or other uses. Do not apply the products to the above listed devices and equipments without prior written permission by ABLIC Inc. Especially, the products cannot be used for life support devices, devices implanted in the human body and devices that directly affect human life, etc.
Prior consultation with our sales office is required when considering the above uses.
ABLIC Inc. is not responsible for damages caused by unauthorized or unspecified use of our products.
9. Semiconductor products may fail or malfunction with some probability.
The user of the products should therefore take responsibility to give thorough consideration to safety design including redundancy, fire spread prevention measures, and malfunction prevention to prevent accidents causing injury or death, fires and social damage, etc. that may ensue from the products' failure or malfunction.
The entire system must be sufficiently evaluated and applied on customer's own responsibility.
10. The products are not designed to be radiation-proof. The necessary radiation measures should be taken in the product design by the customer depending on the intended use.
11. The products do not affect human health under normal use. However, they contain chemical substances and heavy metals and should therefore not be put in the mouth. The fracture surfaces of wafers and chips may be sharp. Be careful when handling these with the bare hands to prevent injuries, etc.
12. When disposing of the products, comply with the laws and ordinances of the country or region where they are used.
13. The information described herein contains copyright information and know-how of ABLIC Inc.
The information described herein does not convey any license under any intellectual property rights or any other rights belonging to ABLIC Inc. or a third party. Reproduction or copying of the information from this document or any part of this document described herein for the purpose of disclosing it to a third-party without the express permission of ABLIC Inc. is strictly prohibited.
14. For more details on the information described herein, contact our sales office.

2.2-2018.06

Mouser Electronics

Authorized Distributor

Click to View Pricing, Inventory, Delivery & Lifecycle Information:

ABLIC:

[S-8425AAAFT-TB-G](#) [S-8425AAAPA-TF-G](#) [S-8425AAAFT-TB-U](#) [S-8425AAFFT-TB-U](#) [S-8425AAGFT-TB-U](#) [S-8425SAAFT-TB-U](#)

Компания «Океан Электроники» предлагает заключение долгосрочных отношений при поставках импортных электронных компонентов на взаимовыгодных условиях!

Наши преимущества:

- Поставка оригинальных импортных электронных компонентов напрямую с производств Америки, Европы и Азии, а так же с крупнейших складов мира;
- Широкая линейка поставок активных и пассивных импортных электронных компонентов (более 30 млн. наименований);
- Поставка сложных, дефицитных, либо снятых с производства позиций;
- Оперативные сроки поставки под заказ (от 5 рабочих дней);
- Экспресс доставка в любую точку России;
- Помощь Конструкторского Отдела и консультации квалифицированных инженеров;
- Техническая поддержка проекта, помощь в подборе аналогов, поставка прототипов;
- Поставка электронных компонентов под контролем ВП;
- Система менеджмента качества сертифицирована по Международному стандарту ISO 9001;
- При необходимости вся продукция военного и аэрокосмического назначения проходит испытания и сертификацию в лаборатории (по согласованию с заказчиком);
- Поставка специализированных компонентов военного и аэрокосмического уровня качества (Xilinx, Altera, Analog Devices, Intersil, Interpoint, Microsemi, Actel, Aeroflex, Peregrine, VPT, Syfer, Eurofarad, Texas Instruments, MS Kennedy, Miteq, Cobham, E2V, MA-COM, Hittite, Mini-Circuits, General Dynamics и др.);

Компания «Океан Электроники» является официальным дистрибьютором и эксклюзивным представителем в России одного из крупнейших производителей разъемов военного и аэрокосмического назначения «JONHON», а так же официальным дистрибьютором и эксклюзивным представителем в России производителя высокотехнологичных и надежных решений для передачи СВЧ сигналов «FORSTAR».



JONHON

«JONHON» (основан в 1970 г.)

Разъемы специального, военного и аэрокосмического назначения:

(Применяются в военной, авиационной, аэрокосмической, морской, железнодорожной, горно- и нефтедобывающей отраслях промышленности)

«FORSTAR» (основан в 1998 г.)

ВЧ соединители, коаксиальные кабели, кабельные сборки и микроволновые компоненты:

(Применяются в телекоммуникациях гражданского и специального назначения, в средствах связи, РЛС, а так же военной, авиационной и аэрокосмической отраслях промышленности).



Телефон: 8 (812) 309-75-97 (многоканальный)

Факс: 8 (812) 320-03-32

Электронная почта: ocean@oceanchips.ru

Web: <http://oceanchips.ru/>

Адрес: 198099, г. Санкт-Петербург, ул. Калинина, д. 2, корп. 4, лит. А