

## 600 nA, Non-Unity Gain Rail-to-Rail Input/Output Op Amps

### Features:

- Low Quiescent Current: 600 nA/amplifier (typical)
- Gain Bandwidth Product: 100 kHz (typical)
- Stable for gains of 10 V/V or higher
- Rail-to-Rail Input/Output
- Wide Supply Voltage Range: 1.4V to 6.0V
- Available in Single, Dual, and Quad
- Chip Select ( $\overline{CS}$ ) with MCP6143
- Available in 5-lead and 6-lead SOT-23 Packages
- Temperature Ranges:
  - Industrial: -40°C to +85°C
  - Extended: -40°C to +125°C

### Applications:

- Toll Booth Tags
- Wearable Products
- Temperature Measurement
- Battery Powered

### Design Aids:

- SPICE Macro Models
- FilterLab<sup>®</sup> Software
- Mindi<sup>™</sup> Simulation Tool
- Microchip Advanced Part Selector (MAPS)
- Analog Demonstration and Evaluation Boards
- Application Notes

### Related Devices:

- MCP6041/2/3/4: Unity Gain Stable Op Amps

### Typical Application



### Description:

The MCP6141/2/3/4 family of non-unity gain stable operational amplifiers (op amps) from Microchip Technology Inc. operate with a single supply voltage as low as 1.4V, while drawing less than 1  $\mu$ A (maximum) of quiescent current per amplifier. These devices are also designed to support rail-to-rail input and output operation. This combination of features supports battery-powered and portable applications.

The MCP6141/2/3/4 amplifiers have a gain bandwidth product of 100 kHz (typical) and are stable for gains of 10 V/V or higher. These specifications make these op amps appropriate for battery powered applications where a higher frequency response from the amplifier is required.

The MCP6141/2/3/4 family operational amplifiers are offered in single (MCP6141), single with Chip Select ( $\overline{CS}$ ) (MCP6143), dual (MCP6142) and quad (MCP6144) configurations. The MCP6141 device is available in the 5-lead SOT-23 package, and the MCP6143 device is available in the 6-lead SOT-23 package.

### Package Types



# MCP6141/2/3/4

---

NOTES:

## 1.0 ELECTRICAL CHARACTERISTICS

### Absolute Maximum Ratings †

$V_{DD} - V_{SS}$ .....	7.0V
Current at Analog Input Pins .....	±2 mA
Analog Inputs ( $V_{IN+}$ , $V_{IN-}$ ) †† .....	$V_{SS} - 1.0V$ to $V_{DD} + 1.0V$
All Other Inputs and Outputs .....	$V_{SS} - 0.3V$ to $V_{DD} + 0.3V$
Difference Input Voltage .....	$ V_{DD} - V_{SS} $
Output Short Circuit Current .....	Continuous
Current at Output and Supply Pins .....	±30 mA
Storage Temperature .....	-65°C to +150°C
Maximum Junction Temperature ( $T_J$ ) .....	+150°C
ESD Protection On All Pins (HBM; MM) .....	≥ 4 kV; 400V

† **Notice:** Stresses above those listed under “Absolute Maximum Ratings” may cause permanent damage to the device. This is a stress rating only and functional operation of the device at those or any other conditions above those indicated in the operational listings of this specification is not implied. Exposure to maximum rating conditions for extended periods may affect device reliability.

†† See Section 4.1.2 “Input Voltage and Current Limits”.

### DC ELECTRICAL CHARACTERISTICS

**Electrical Characteristics:** Unless otherwise indicated,  $V_{DD} = +1.4V$  to  $+5.5V$ ,  $V_{SS} = GND$ ,  $T_A = +25^\circ C$ ,  $V_{CM} = V_{DD}/2$ ,  $V_{OUT} \approx V_{DD}/2$ ,  $V_L = V_{DD}/2$ ,  $R_L = 1 M\Omega$  to  $V_L$  and  $CS$  is tied low (refer to Figure 1-2 and Figure 1-3).

Parameters	Sym	Min	Typ	Max	Units	Conditions
<b>Input Offset</b>						
Input Offset Voltage	$V_{OS}$	-3	—	+3	mV	$V_{CM} = V_{SS}$
Drift with Temperature	$\Delta V_{OS}/\Delta T_A$	—	±1.8	—	$\mu V/^\circ C$	$V_{CM} = V_{SS}$ , $T_A = -40^\circ C$ to $+85^\circ C$
	$\Delta V_{OS}/\Delta T_A$	—	±10	—	$\mu V/^\circ C$	$V_{CM} = V_{SS}$ , $T_A = +85^\circ C$ to $+125^\circ C$
Power Supply Rejection	PSRR	70	85	—	dB	$V_{CM} = V_{SS}$
<b>Input Bias Current and Impedance</b>						
Input Bias Current	$I_B$	—	1	—	pA	
Industrial Temperature Extended Temperature	$I_B$	—	20	100	pA	$T_A = +85^\circ$
	$I_B$	—	1200	5000	pA	$T_A = +125^\circ$
Input Offset Current	$I_{OS}$	—	1	—	pA	
Common Mode Input Impedance	$Z_{CM}$	—	$10^{13}  6$	—	$\Omega  pF$	
Differential Input Impedance	$Z_{DIFF}$	—	$10^{13}  6$	—	$\Omega  pF$	
<b>Common Mode</b>						
Common-Mode Input Range	$V_{CMR}$	$V_{SS}-0.3$	—	$V_{DD}+0.3$	V	
Common-Mode Rejection Ratio	CMRR	62	80	—	dB	$V_{DD} = 5V$ , $V_{CM} = -0.3V$ to $5.3V$
	CMRR	60	75	—	dB	$V_{DD} = 5V$ , $V_{CM} = 2.5V$ to $5.3V$
	CMRR	60	80	—	dB	$V_{DD} = 5V$ , $V_{CM} = -0.3V$ to $2.5V$
<b>Open-Loop Gain</b>						
DC Open-Loop Gain (large signal)	$A_{OL}$	95	115	—	dB	$R_L = 50 k\Omega$ to $V_L$ , $V_{OUT} = 0.1V$ to $V_{DD}-0.1V$
<b>Output</b>						
Maximum Output Voltage Swing	$V_{OL}$ , $V_{OH}$	$V_{SS} + 10$	—	$V_{DD} - 10$	mV	$R_L = 50 k\Omega$ to $V_L$ , 0.5V input overdrive
Linear Region Output Voltage Swing	$V_{OVR}$	$V_{SS} + 100$	—	$V_{DD} - 100$	mV	$R_L = 50 k\Omega$ to $V_L$ , $A_{OL} \geq 95$ dB
Output Short Circuit Current	$I_{SC}$	—	2	—	mA	$V_{DD} = 1.4V$
	$I_{SC}$	—	20	—	mA	$V_{DD} = 5.5V$
<b>Power Supply</b>						
Supply Voltage	$V_{DD}$	1.4	—	6.0	V	<b>Note 1</b>
Quiescent Current per Amplifier	$I_Q$	0.3	0.6	1.0	$\mu A$	$I_O = 0$

**Note 1:** All parts with date codes February 2008 and later have been screened to ensure operation at  $V_{DD} = 6.0V$ . However, the other minimum and maximum specifications are measured at 1.8V and 5.5V

# MCP6141/2/3/4

## AC ELECTRICAL CHARACTERISTICS

**Electrical Characteristics:** Unless otherwise indicated,  $V_{DD} = +1.4V$  to  $+5.5V$ ,  $V_{SS} = GND$ ,  $T_A = +25^\circ C$ ,  $V_{CM} = V_{DD}/2$ ,  $V_{OUT} \approx V_{DD}/2$ ,  $V_L = V_{DD}/2$ ,  $R_L = 1 M\Omega$  to  $V_L$ ,  $C_L = 60$  pF and CS is tied low (refer to Figure 1-2 and Figure 1-3).

Parameters	Sym	Min	Typ	Max	Units	Conditions
<b>AC Response</b>						
Gain Bandwidth Product	GBWP	—	100	—	kHz	
Slew Rate	SR	—	24	—	V/ms	
Phase Margin	PM	—	60	—	°	G = +10 V/V
<b>Noise</b>						
Input Voltage Noise	$E_{ni}$	—	5.0	—	$\mu V_{P-P}$	f = 0.1 Hz to 10 Hz
Input Voltage Noise Density	$e_{ni}$	—	170	—	nV/ $\sqrt{Hz}$	f = 1 kHz
Input Current Noise Density	$i_{ni}$	—	0.6	—	fA/ $\sqrt{Hz}$	f = 1 kHz

## MCP6143 CHIP SELECT ( $\overline{CS}$ ) ELECTRICAL CHARACTERISTICS

**Electrical Characteristics:** Unless otherwise indicated,  $V_{DD} = +1.4V$  to  $+5.5V$ ,  $V_{SS} = GND$ ,  $T_A = +25^\circ C$ ,  $V_{CM} = V_{DD}/2$ ,  $V_{OUT} \approx V_{DD}/2$ ,  $V_L = V_{DD}/2$ ,  $R_L = 1 M\Omega$  to  $V_L$ , and  $C_L = 60$  pF (refer to Figure 1-2 and Figure 1-3).

Parameters	Sym	Min	Typ	Max	Units	Conditions
<b><math>\overline{CS}</math> Low Specifications</b>						
$\overline{CS}$ Logic Threshold, Low	$V_{IL}$	$V_{SS}$	—	$V_{SS}+0.3$	V	
$\overline{CS}$ Input Current, Low	$I_{CSL}$	—	5	—	pA	$\overline{CS} = V_{SS}$
<b><math>\overline{CS}</math> High Specifications</b>						
$\overline{CS}$ Logic Threshold, High	$V_{IH}$	$V_{DD}-0.3$	—	$V_{DD}$	V	
$\overline{CS}$ Input Current, High	$I_{CSH}$	—	5	—	pA	$\overline{CS} = V_{DD}$
$\overline{CS}$ Input High, GND Current	$I_{SS}$	—	-20	—	pA	$\overline{CS} = V_{DD}$
Amplifier Output Leakage, $\overline{CS}$ High	$I_{OLEAK}$	—	20	—	pA	$\overline{CS} = V_{DD}$
<b>Dynamic Specifications</b>						
$\overline{CS}$ Low to Amplifier Output Turn-on Time	$t_{ON}$	—	2	50	ms	G = +1 V/V, $\overline{CS} = 0.3V$ to $V_{OUT} = 0.9V_{DD}/2$
$\overline{CS}$ High to Amplifier Output High-Z	$t_{OFF}$	—	10	—	$\mu s$	G = +1 V/V, $\overline{CS} = V_{DD}-0.3V$ to $V_{OUT} = 0.1V_{DD}/2$
Hysteresis	$V_{HYST}$	—	0.6	—	V	$V_{DD} = 5.0V$

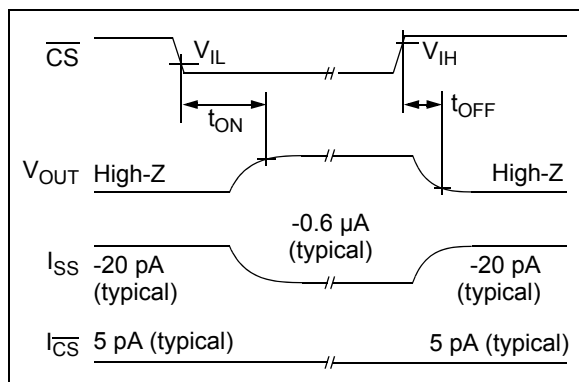

**FIGURE 1-1:** Chip Select ( $\overline{CS}$ ) Timing Diagram (MCP6143 only).

## TEMPERATURE CHARACTERISTICS

Electrical Characteristics: Unless otherwise indicated, $V_{DD} = +1.4V$ to $+5.5V$ , $V_{SS} = GND$ .						
Parameters	Sym.	Min.	Typ.	Max.	Units	Conditions
Temperature Ranges						
Specified Temperature Range	$T_A$	-40	—	+85	°C	Industrial Temperature parts
	$T_A$	-40	—	+125	°C	Extended Temperature parts
Operating Temperature Range	$T_A$	-40	—	+125	°C	<b>(Note 1)</b>
Storage Temperature Range	$T_A$	-65	—	+150	°C	
Thermal Package Resistances						
Thermal Resistance, 5L-SOT-23	$\theta_{JA}$	—	256	—	°C/W	
Thermal Resistance, 6L-SOT-23	$\theta_{JA}$	—	230	—	°C/W	
Thermal Resistance, 8L-MSOP	$\theta_{JA}$	—	206	—	°C/W	
Thermal Resistance, 8L-PDIP	$\theta_{JA}$	—	85	—	°C/W	
Thermal Resistance, 8L-SOIC	$\theta_{JA}$	—	163	—	°C/W	
Thermal Resistance, 14L-PDIP	$\theta_{JA}$	—	70	—	°C/W	
Thermal Resistance, 14L-SOIC	$\theta_{JA}$	—	120	—	°C/W	
Thermal Resistance, 14L-TSSOP	$\theta_{JA}$	—	100	—	°C/W	

**Note 1:** The MCP6141/2/3/4 family of Industrial Temperature op amps operates over this extended range, but with reduced performance. In any case, the internal Junction Temperature ( $T_J$ ) must not exceed the Absolute Maximum specification of  $+150^\circ\text{C}$ .

### 1.1 Test Circuits

The test circuits used for the DC and AC tests are shown in [Figure 1-2](#) and [Figure 1-2](#). The bypass capacitors are laid out according to the rules discussed in [Section 4.6 “Supply Bypass”](#).



**FIGURE 1-2:** AC and DC Test Circuit for Most Non-Inverting Gain Conditions.



**FIGURE 1-3:** AC and DC Test Circuit for Most Inverting Gain Conditions.

# MCP6141/2/3/4

---

NOTES:

## 2.0 TYPICAL PERFORMANCE CURVES

**Note:** The graphs and tables provided following this note are a statistical summary based on a limited number of samples and are provided for informational purposes only. The performance characteristics listed herein are not tested or guaranteed. In some graphs or tables, the data presented may be outside the specified operating range (e.g., outside specified power supply range) and therefore outside the warranted range.

**Note:** Unless otherwise indicated,  $T_A = +25^\circ\text{C}$ ,  $V_{DD} = +1.4\text{V}$  to  $+5.5\text{V}$ ,  $V_{SS} = \text{GND}$ ,  $V_{CM} = V_{DD}/2$ ,  $V_{OUT} \approx V_{DD}/2$ ,  $V_L = V_{DD}/2$ ,  $R_L = 1\text{ M}\Omega$  to  $V_L$ ,  $C_L = 60\text{ pF}$ , and CS is tied low.



**FIGURE 2-1:** Input Offset Voltage.

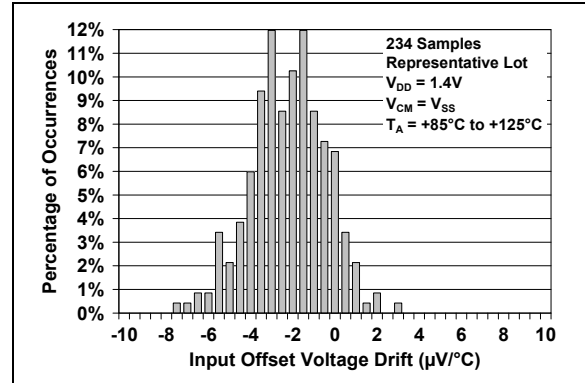

**FIGURE 2-4:** Input Offset Voltage Drift with  $T_A = +85^\circ\text{C}$  to  $+125^\circ\text{C}$  and  $V_{DD} = 1.4\text{V}$ .

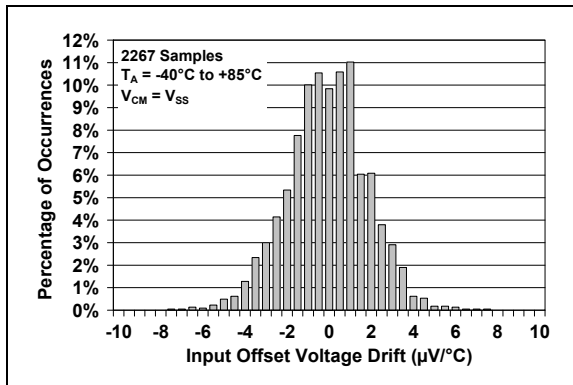

**FIGURE 2-2:** Input Offset Voltage Drift with  $T_A = -40^\circ\text{C}$  to  $+85^\circ\text{C}$ .

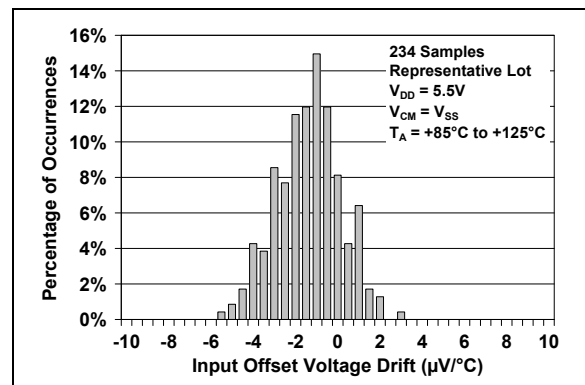

**FIGURE 2-5:** Input Offset Voltage Drift with  $T_A = +85^\circ\text{C}$  to  $+125^\circ\text{C}$  and  $V_{DD} = 5.5\text{V}$ .

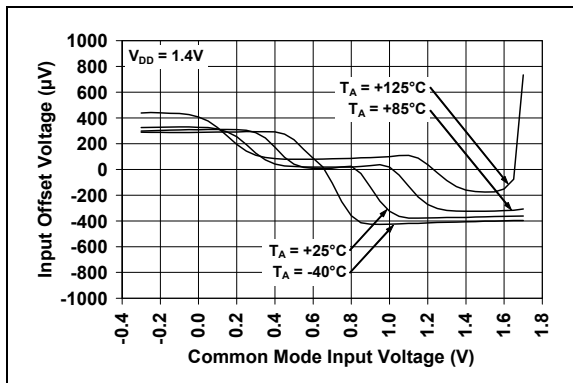

**FIGURE 2-3:** Input Offset Voltage vs. Common Mode Input Voltage with  $V_{DD} = 1.4\text{V}$ .

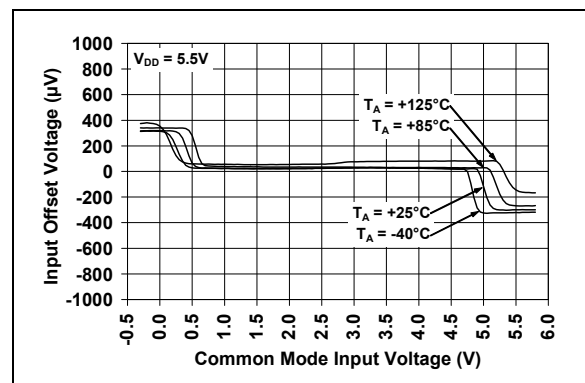

**FIGURE 2-6:** Input Offset Voltage vs. Common Mode Input Voltage with  $V_{DD} = 5.5\text{V}$ .

# MCP6141/2/3/4

**Note:** Unless otherwise indicated,  $T_A = +25^\circ\text{C}$ ,  $V_{DD} = +1.4\text{V}$  to  $+5.5\text{V}$ ,  $V_{SS} = \text{GND}$ ,  $V_{CM} = V_{DD}/2$ ,  $V_{OUT} \approx V_{DD}/2$ ,  $V_L = V_{DD}/2$ ,  $R_L = 1\text{ M}\Omega$  to  $V_L$ ,  $C_L = 60\text{ pF}$ , and  $\overline{\text{CS}}$  is tied low.

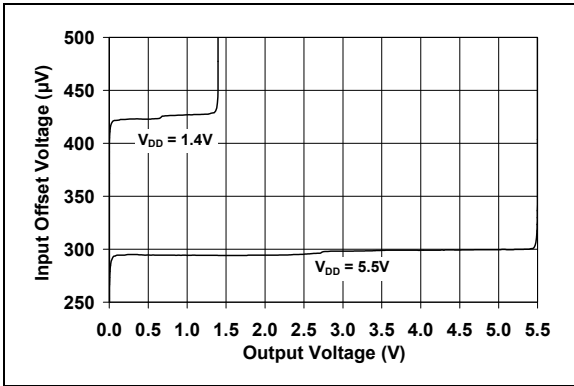

**FIGURE 2-7:** Input Offset Voltage vs. Output Voltage.



**FIGURE 2-10:** The MCP6141/2/3/4 Family Shows No Phase Reversal.

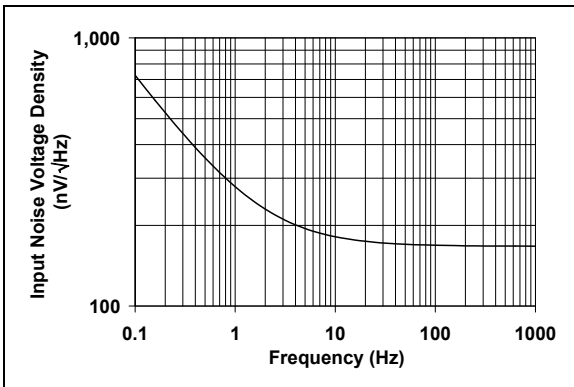

**FIGURE 2-8:** Input Noise Voltage Density vs. Frequency.



**FIGURE 2-11:** Input Noise Voltage Density vs. Common Mode Input Voltage.

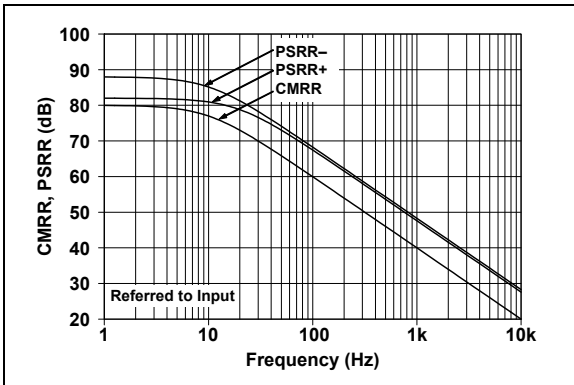

**FIGURE 2-9:** CMRR, PSRR vs. Frequency.



**FIGURE 2-12:** CMRR, PSRR vs. Ambient Temperature.



**Note:** Unless otherwise indicated,  $T_A = +25^\circ\text{C}$ ,  $V_{DD} = +1.4\text{V}$  to  $+5.5\text{V}$ ,  $V_{SS} = \text{GND}$ ,  $V_{CM} = V_{DD}/2$ ,  $V_{OUT} \approx V_{DD}/2$ ,  $V_L = V_{DD}/2$ ,  $R_L = 1\text{ M}\Omega$  to  $V_L$ ,  $C_L = 60\text{ pF}$ , and  $\overline{\text{CS}}$  is tied low.



**FIGURE 2-13:** Input Bias, Offset Currents vs. Ambient Temperature.



**FIGURE 2-16:** Input Bias, Offset Currents vs. Common Mode Input Voltage.



**FIGURE 2-14:** Open-Loop Gain, Phase vs. Frequency.



**FIGURE 2-17:** DC Open-Loop Gain vs. Load Resistance.

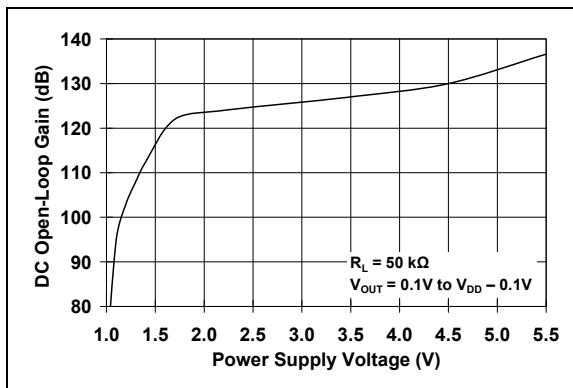

**FIGURE 2-15:** DC Open-Loop Gain vs. Power Supply Voltage.

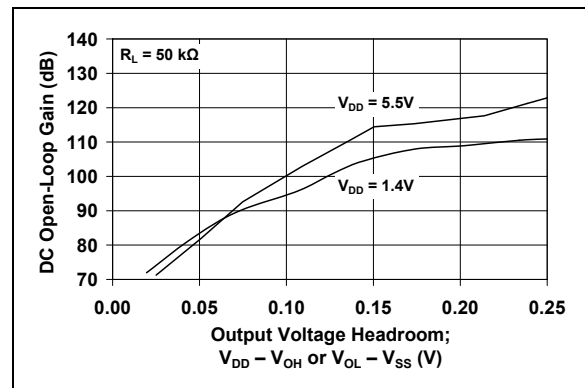

**FIGURE 2-18:** DC Open-Loop Gain vs. Output Voltage Headroom.

# MCP6141/2/3/4

**Note:** Unless otherwise indicated,  $T_A = +25^\circ\text{C}$ ,  $V_{DD} = +1.4\text{V}$  to  $+5.5\text{V}$ ,  $V_{SS} = \text{GND}$ ,  $V_{CM} = V_{DD}/2$ ,  $V_{OUT} \approx V_{DD}/2$ ,  $V_L = V_{DD}/2$ ,  $R_L = 1\text{ M}\Omega$  to  $V_L$ ,  $C_L = 60\text{ pF}$ , and  $\overline{\text{CS}}$  is tied low.



**FIGURE 2-19:** Channel to Channel Separation vs. Frequency (MCP6142 and MCP6144 only).



**FIGURE 2-22:** Gain Bandwidth Product, Phase Margin vs. Common Mode Input Voltage.



**FIGURE 2-20:** Gain Bandwidth Product, Phase Margin vs. Ambient Temperature with  $V_{DD} = 1.4\text{V}$ .



**FIGURE 2-23:** Gain Bandwidth Product, Phase Margin vs. Ambient Temperature with  $V_{DD} = 5.5\text{V}$ .



**FIGURE 2-21:** Quiescent Current vs. Power Supply Voltage.



**FIGURE 2-24:** Output Short Circuit Current vs. Power Supply Voltage.

**Note:** Unless otherwise indicated,  $T_A = +25^\circ\text{C}$ ,  $V_{DD} = +1.4\text{V}$  to  $+5.5\text{V}$ ,  $V_{SS} = \text{GND}$ ,  $V_{CM} = V_{DD}/2$ ,  $V_{OUT} \approx V_{DD}/2$ ,  $V_L = V_{DD}/2$ ,  $R_L = 1\text{ M}\Omega$  to  $V_L$ ,  $C_L = 60\text{ pF}$ , and  $\overline{\text{CS}}$  is tied low.



**FIGURE 2-25:** Output Voltage Headroom vs. Output Current Magnitude.



**FIGURE 2-28:** Output Voltage Headroom vs. Ambient Temperature.



**FIGURE 2-26:** Slew Rate vs. Ambient Temperature.



**FIGURE 2-29:** Maximum Output Voltage Swing vs. Frequency.



**FIGURE 2-27:** Small Signal Non-inverting Pulse Response.



**FIGURE 2-30:** Small Signal Inverting Pulse Response.

# MCP6141/2/3/4

**Note:** Unless otherwise indicated,  $T_A = +25^\circ\text{C}$ ,  $V_{DD} = +1.4\text{V}$  to  $+5.5\text{V}$ ,  $V_{SS} = \text{GND}$ ,  $V_{CM} = V_{DD}/2$ ,  $V_{OUT} \approx V_{DD}/2$ ,  $V_L = V_{DD}/2$ ,  $R_L = 1\text{ M}\Omega$  to  $V_L$ ,  $C_L = 60\text{ pF}$ , and  $\overline{\text{CS}}$  is tied low.



**FIGURE 2-31:** Large Signal Non-inverting Pulse Response.



**FIGURE 2-34:** Large Signal Inverting Pulse Response.

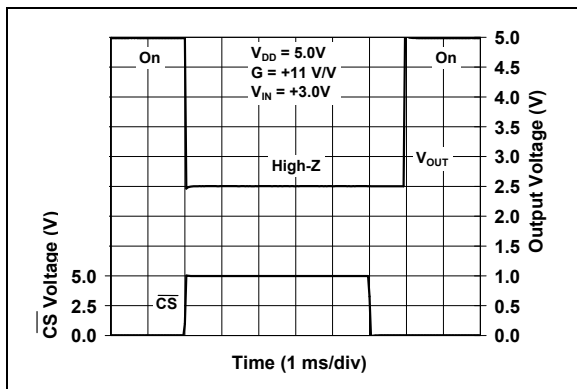

**FIGURE 2-32:** Chip Select ( $\overline{\text{CS}}$ ) to Amplifier Output Response Time (MCP6143 only).

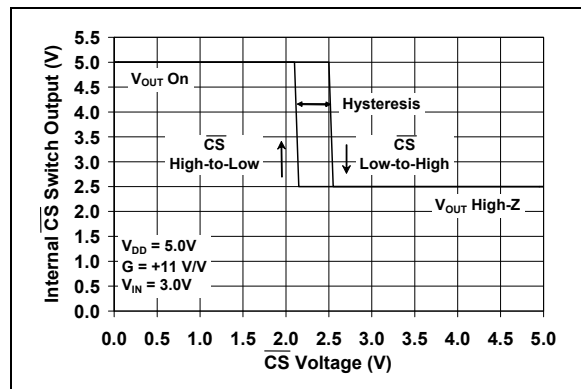

**FIGURE 2-35:** Internal Chip Select ( $\overline{\text{CS}}$ ) Hysteresis (MCP6143 only).



**FIGURE 2-33:** Input Current vs. Input Voltage (Below  $V_{SS}$ ).

## 3.0 PIN DESCRIPTIONS

Descriptions of the pins are listed in [Table 3-1](#).

**TABLE 3-1: PIN FUNCTION TABLE**

MCP6141		MCP6142	MCP6143		MCP6144	Symbol	Description
MSOP, PDIP, SOIC	SOT-23-5	MSOP, PDIP, SOIC	MSOP, PDIP, SOIC	SOT-23-6	MSOP, PDIP, SOIC		
6	1	1	6	1	1	$V_{OUT}, V_{OUTA}$	Analog Output (op amp A)
2	4	2	2	4	2	$V_{IN-}, V_{INA-}$	Inverting Input (op amp A)
3	3	3	3	3	3	$V_{IN+}, V_{INA+}$	Non-inverting Input (op amp A)
7	5	8	7	6	4	$V_{DD}$	Positive Power Supply
—	—	5	—	—	5	$V_{INB+}$	Non-inverting Input (op amp B)
—	—	6	—	—	6	$V_{INB-}$	Inverting Input (op amp B)
—	—	7	—	—	7	$V_{OUTB}$	Analog Output (op amp B)
—	—	—	—	—	8	$V_{OUTC}$	Analog Output (op amp C)
—	—	—	—	—	9	$V_{INC-}$	Inverting Input (op amp C)
—	—	—	—	—	10	$V_{INC+}$	Non-inverting Input (op amp C)
4	2	4	4	2	11	$V_{SS}$	Negative Power Supply
—	—	—	—	—	12	$V_{IND+}$	Non-inverting Input (op amp D)
—	—	—	—	—	13	$V_{IND-}$	Inverting Input (op amp D)
—	—	—	—	—	14	$V_{OUTD}$	Analog Output (op amp D)
—	—	—	8	5	—	$\overline{CS}$	Chip Select
1, 5, 8	—	—	1, 5	—	—	NC	No Internal Connection

### 3.1 Analog Outputs

The output pins are low-impedance voltage sources.

### 3.2 Analog Inputs

The non-inverting and inverting inputs are high-impedance CMOS inputs with low bias currents.

### 3.3 $\overline{CS}$ Digital Input

This is a CMOS, Schmitt-triggered input that places the part into a low power mode of operation.

### 3.4 Power Supply Pins

The positive power supply pin ( $V_{DD}$ ) is 1.4V to 6.0V higher than the negative power supply pin ( $V_{SS}$ ). For normal operation, the other pins are at voltages between  $V_{SS}$  and  $V_{DD}$ .

Typically, these parts are used in a single (positive) supply configuration. In this case,  $V_{SS}$  is connected to ground and  $V_{DD}$  is connected to the supply.  $V_{DD}$  will need bypass capacitors.

# MCP6141/2/3/4

---

NOTES:

## 4.0 APPLICATIONS INFORMATION

The MCP6141/2/3/4 family of op amps is manufactured using Microchip's state of the art CMOS process. These op amps are stable for gains of 10 V/V and higher. They are suitable for a wide range of general purpose, low power applications.

See Microchip's related MCP6041/2/3/4 family of op amps for applications needing unity gain stability.

### 4.1 Rail-to-Rail Input

#### 4.1.1 PHASE REVERSAL

The MCP6141/2/3/4 op amps are designed to not exhibit phase inversion when the input pins exceed the supply voltages. Figure 2-10 shows an input voltage exceeding both supplies with no phase inversion.

#### 4.1.2 INPUT VOLTAGE AND CURRENT LIMITS

The ESD protection on the inputs can be depicted as shown in Figure 4-1. This structure was chosen to protect the input transistors, and to minimize input bias current ( $I_B$ ). The input ESD diodes clamp the inputs when they try to go more than one diode drop below  $V_{SS}$ . They also clamp any voltages that go too far above  $V_{DD}$ ; their breakdown voltage is high enough to allow normal operation, and low enough to bypass quick ESD events within the specified limits.



**FIGURE 4-1:** Simplified Analog Input ESD Structures.

In order to prevent damage and/or improper operation of these amplifiers, the circuit must limit the currents (and voltages) at the input pins (see **Absolute Maximum Ratings †** at the beginning of **Section 1.0 "Electrical Characteristics"**). Figure 4-2 shows the recommended approach to protecting these inputs. The internal ESD diodes prevent the input pins ( $V_{IN+}$  and  $V_{IN-}$ ) from going too far below ground, and the resistors  $R_1$  and  $R_2$  limit the possible current drawn out of the input pins. Diodes  $D_1$  and  $D_2$  prevent the input pins ( $V_{IN+}$  and  $V_{IN-}$ ) from going too far above  $V_{DD}$ , and

dump any currents onto  $V_{DD}$ . When implemented as shown, resistors  $R_1$  and  $R_2$  also limit the current through  $D_1$  and  $D_2$ .



**FIGURE 4-2:** Protecting the Analog Inputs.

It is also possible to connect the diodes to the left of the resistor  $R_1$  and  $R_2$ . In this case, the currents through the diodes  $D_1$  and  $D_2$  need to be limited by some other mechanism. The resistors then serve as in-rush current limiters; the DC current into the input pins ( $V_{IN+}$  and  $V_{IN-}$ ) should be very small.

A significant amount of current can flow out of the inputs (through the ESD diodes) when the common mode voltage ( $V_{CM}$ ) is below ground ( $V_{SS}$ ); see Figure 2-33. Applications that are high impedance may need to limit the usable voltage range.

#### 4.1.3 NORMAL OPERATION

The input stage of the MCP6141/2/3/4 op amps uses two differential input stages in parallel. One operates at a low common mode input voltage ( $V_{CM}$ ), while the other operates at a high  $V_{CM}$ . With this topology, the device operates with a  $V_{CM}$  up to 300 mV above  $V_{DD}$  and 300 mV below  $V_{SS}$ . The input offset voltage is measured at  $V_{CM} = V_{SS} - 0.3V$  and  $V_{DD} + 0.3V$  to ensure proper operation.

There are two transitions in input behavior as  $V_{CM}$  is changed. The first occurs, when  $V_{CM}$  is near  $V_{SS} + 0.4V$ , and the second occurs when  $V_{CM}$  is near  $V_{DD} - 0.5V$  (see Figure 2-3 and Figure 2-6). For the best distortion performance with non-inverting gains, avoid these regions of operation.

# MCP6141/2/3/4

## 4.2 Rail-to-Rail Output

There are two specifications that describe the output swing capability of the MCP6141/2/3/4 family of op amps. The first specification (Maximum Output Voltage Swing) defines the absolute maximum swing that can be achieved under the specified load condition. Thus, the output voltage swings to within 10 mV of either supply rail with a 50 kΩ load to  $V_{DD}/2$ . Figure 2-10 shows how the output voltage is limited when the input goes beyond the linear region of operation.

The second specification that describes the output swing capability of these amplifiers is the Linear Output Voltage Range. This specification defines the maximum output swing that can be achieved while the amplifier still operates in its linear region. To verify linear operation in this range, the large signal DC Open-Loop Gain ( $A_{OL}$ ) is measured at points inside the supply rails. The measurement must meet the specified  $A_{OL}$  condition in the specification table.

## 4.3 Output Loads and Battery Life

The MCP6141/2/3/4 op amp family has outstanding quiescent current, which supports battery-powered applications. There is minimal quiescent current glitching when Chip Select (CS) is raised or lowered. This prevents excessive current draw, and reduced battery life, when the part is turned off or on.

Heavy resistive loads at the output can cause excessive battery drain. Driving a DC voltage of 2.5V across a 100 kΩ load resistor will cause the supply current to increase by 25 μA, depleting the battery 43 times as fast as  $I_Q$  (0.6 μA, typical) alone.

High frequency signals (fast edge rate) across capacitive loads will also significantly increase supply current. For instance, a 0.1 μF capacitor at the output presents an AC impedance of 15.9 kΩ (1/2πfC) to a 100 Hz sinewave. It can be shown that the average power drawn from the battery by a 5.0 V<sub>P-P</sub> sinewave (1.77 V<sub>rms</sub>), under these conditions, is:

### EQUATION 4-1:

$$\begin{aligned}
 P_{Supply} &= (V_{DD} - V_{SS}) (I_Q + V_{L(p-p)} f C_L) \\
 &= (5V)(0.6 \mu A + 5.0V_{p-p} \cdot 100Hz \cdot 0.1\mu F) \\
 &= 3.0 \mu W + 50 \mu W
 \end{aligned}$$

This will drain the battery 18 times as fast as  $I_Q$  alone.

## 4.4 Stability

### 4.4.1 NOISE GAIN

The MCP6141/2/3/4 op amp family is designed to give high bandwidth and slew rate for circuits with high noise gain ( $G_N$ ) or signal gain. Low gain applications should be realized using the MCP6041/2/3/4 op amp family; this simplifies design and implementation issues.

Noise gain is defined to be the gain from a voltage source at the non-inverting input to the output when all other voltage sources are zeroed (shorted out). Noise gain is independent of signal gain and depends only on components in the feedback loop. The amplifier circuits in Figure 4-3 and Figure 4-4 have their noise gain calculated as follows:

### EQUATION 4-2:

$$G_N = 1 + \frac{R_F}{R_G} \geq 10 \text{ V/V}$$

In order for the amplifiers to be stable, the noise gain should meet the specified minimum noise gain. Note that a noise gain of  $G_N = +10 \text{ V/V}$  corresponds to a non-inverting signal gain of  $G = +10 \text{ V/V}$ , or to an inverting signal gain of  $G = -9 \text{ V/V}$ .



**FIGURE 4-3:** Noise Gain for Non-inverting Gain Configuration.



**FIGURE 4-4:** Noise Gain for Inverting Gain Configuration.



Figure 4-5 shows three example circuits that are unstable when used with the MCP6141/2/3/4 family. The unity gain buffer and low gain amplifier (non-inverting or inverting) are at gains that are too low for stability (see Equation 4-2). The Miller integrator's capacitor makes it reach unity gain at high frequencies, causing instability.

**Note:** The three circuits shown in Figure 4-5 are not to be used with the MCP6141/2/3/4 op amps. They are included for illustrative purposes only.



**FIGURE 4-5:** Examples of Unstable Circuits for the MCP6141/2/3/4 Family.

#### 4.4.2 CAPACITIVE LOADS

Driving large capacitive loads can cause stability problems for voltage feedback op amps. As the load capacitance increases, the feedback loop's phase margin decreases and the closed-loop bandwidth is reduced. This produces gain peaking in the frequency response, with overshoot and ringing in the step response. A unity gain buffer ( $G = +1$ ) is the most sensitive to capacitive loads, though all gains show the same general behavior.

When driving large capacitive loads with these op amps (e.g.,  $> 60$  pF when  $G = +10$ ), a small series resistor at the output ( $R_{ISO}$  in Figure 4-6) improves the feedback loop's phase margin (stability) by making the output load resistive at higher frequencies. The bandwidth will be generally lower than the bandwidth with no capacitive load.



**FIGURE 4-6:** Output Resistor,  $R_{ISO}$  stabilizes large capacitive loads.

Figure 4-7 gives recommended  $R_{ISO}$  values for different capacitive loads and gains. The x-axis is the normalized load capacitance ( $C_L/G_N$ ), where  $G_N$  is the circuit's noise gain. For non-inverting gains,  $G_N$  and the Signal Gain are equal. For inverting gains,  $G_N$  is  $1 + |\text{Signal Gain}|$  (e.g.,  $-9$  V/V gives  $G_N = +10$  V/V).



**FIGURE 4-7:** Recommended  $R_{ISO}$  Values for Capacitive Loads.

After selecting  $R_{ISO}$  for your circuit, double check the resulting frequency response peaking and step response overshoot. Modify  $R_{ISO}$ 's value until the response is reasonable. Bench evaluation and simulations with the MCP6141/2/3/4 SPICE macro model are helpful.

#### 4.5 MCP6143 Chip Select

The MCP6143 is a single op amp with Chip Select (CS). When CS is pulled high, the supply current drops to 50 nA (typical) and flows through the CS pin to  $V_{SS}$ . When this happens, the amplifier output is put into a high impedance state. By pulling CS low, the amplifier is enabled. If the CS pin is left floating, the amplifier will not operate properly. Figure 1-1 shows the output voltage and supply current response to a CS pulse.

# MCP6141/2/3/4

## 4.6 Supply Bypass

With this family of operational amplifiers, the power supply pin ( $V_{DD}$  for single supply) should have a local bypass capacitor (i.e., 0.01  $\mu\text{F}$  to 0.1  $\mu\text{F}$ ) within 2 mm for good high frequency performance. It can use a bulk capacitor (i.e., 1  $\mu\text{F}$  or larger) within 100 mm to provide large, slow currents. This bulk capacitor is not required for most applications and can be shared with other nearby analog parts.

## 4.7 Unused Op Amps

An unused op amp in a quad package (MCP6144) should be configured as shown in Figure 4-8. These circuits prevent the output from toggling and causing crosstalk.

Circuit A sets the op amp near its minimum noise gain. The resistor divider produces any desired reference voltage within the output voltage range of the op amp; the op amp buffers that reference voltage. Circuit B uses the minimum number of components and operates as a comparator, but it may draw more current.



FIGURE 4-8: Unused Op Amps.

## 4.8 PCB Surface Leakage

In applications where low input bias current is critical, printed circuit board (PCB) surface leakage effects need to be considered. Surface leakage is caused by humidity, dust or other contamination on the board. Under low humidity conditions, a typical resistance between nearby traces is  $10^{12}\Omega$ . A 5V difference would cause 5 pA of current to flow, which is greater than the MCP6141/2/3/4 family's bias current at +25°C (1 pA, typical).

The easiest way to reduce surface leakage is to use a guard ring around sensitive pins (or traces). The guard ring is biased at the same voltage as the sensitive pin. An example of this type of layout is shown in Figure 4-9.



FIGURE 4-9: Example Guard Ring Layout for Inverting Gain.

1. Non-inverting Gain and Unity Gain Buffer:
  - a) Connect the non-inverting pin ( $V_{IN+}$ ) to the input with a wire that does not touch the PCB surface.
  - b) Connect the guard ring to the inverting input pin ( $V_{IN-}$ ). This biases the guard ring to the common mode input voltage.
2. Inverting Gain and Transimpedance Gain (convert current to voltage, such as photo detectors) amplifiers:
  - a) Connect the guard ring to the non-inverting input pin ( $V_{IN+}$ ). This biases the guard ring to the same reference voltage as the op amp (e.g.,  $V_{DD}/2$  or ground).
  - b) Connect the inverting pin ( $V_{IN-}$ ) to the input with a wire that does not touch the PCB surface.

## 4.9 Application Circuits

### 4.9.1 BATTERY CURRENT SENSING

The MCP6141/2/3/4 op amps' Common Mode Input Range, which goes 0.3V beyond both supply rails, supports their use in high side and low side battery current sensing applications. The very low quiescent current (0.6  $\mu$ A, typical) help prolong battery life, and the rail-to-rail output supports detection low currents.

Figure 4-10 shows a high side battery current sensor circuit. The 1 k $\Omega$  resistor is sized to minimize power losses. The battery current ( $I_{DD}$ ) through the 1 k $\Omega$  resistor causes its top terminal to be more negative than the bottom terminal. This keeps the common mode input voltage of the op amp below  $V_{DD}$ , which is within its allowed range. When no current is flowing, the output will be at its Maximum Output Voltage Swing ( $V_{OH}$ ), which is virtually at  $V_{DD}$ .

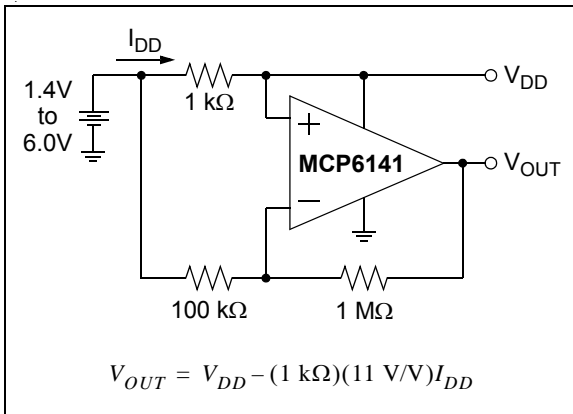

**FIGURE 4-10:** High Side Battery Current Sensor.

### 4.9.2 INVERTING SUMMING AMPLIFIER

The MCP6141/2/3/4 op amp is well suited for the inverting summing amplifier shown in Figure 4-11 when the resistors at the input ( $R_1$ ,  $R_2$ , and  $R_3$ ) make the noise gain at least 10 V/V. The output voltage ( $V_{OUT}$ ) is a weighted sum of the inputs ( $V_1$ ,  $V_2$ , and  $V_3$ ), and is shifted by the  $V_{REF}$  input. The necessary calculations follow in Equation 4-3.

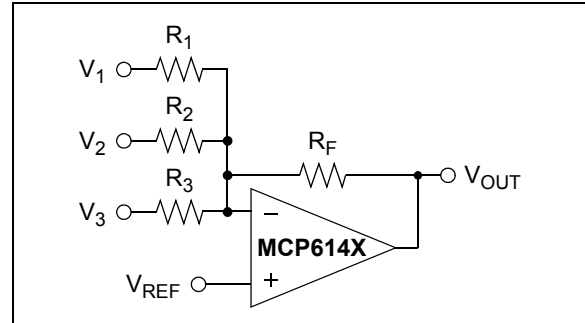

**FIGURE 4-11:** Summing Amplifier.

#### EQUATION 4-3:

**Noise Gain:**

$$G_N = 1 + R_F \left( \frac{1}{R_1} + \frac{1}{R_2} + \frac{1}{R_3} \right) \geq 10 \text{ V/V}$$

**Signal Gains:**

$$G_1 = -R_F/R_1$$

$$G_2 = -R_F/R_2$$

$$G_3 = -R_F/R_3$$

**Output Signal:**

$$V_{OUT} = V_1 G_1 + V_2 G_2 + V_3 G_3 + V_{REF} G_N$$

# MCP6141/2/3/4

---

NOTES:

## 5.0 DESIGN AIDS

Microchip provides the basic design tools needed for the MCP6141/2/3/4 family of op amps.

### 5.1 SPICE Macro Model

The latest SPICE macro model for the MCP6141/2/3/4 op amps is available on the Microchip web site at [www.microchip.com](http://www.microchip.com). This model is intended to be an initial design tool that works well in the op amp's linear region of operation over the temperature range. See the model file for information on its capabilities.

Bench testing is a very important part of any design and cannot be replaced with simulations. Also, simulation results using this macro model need to be validated by comparing them to the data sheet specifications and characteristic curves.

### 5.2 FilterLab<sup>®</sup> Software

Microchip's FilterLab<sup>®</sup> software is an innovative software tool that simplifies analog active filter (using op amps) design. Available at no cost from the Microchip web site at [www.microchip.com/filterlab](http://www.microchip.com/filterlab), the FilterLab design tool provides full schematic diagrams of the filter circuit with component values. It also outputs the filter circuit in SPICE format, which can be used with the macro model to simulate actual filter performance.

### 5.3 Mindi<sup>™</sup> Simulation Tool

Microchip's Mindi<sup>™</sup> simulation tool aids in the design of various circuits useful for active filter, amplifier and power-management applications. It is a free online simulation tool available from the Microchip web site at [www.microchip.com/mindi](http://www.microchip.com/mindi). This interactive simulator enables designers to quickly generate circuit diagrams, simulate circuits. Circuits developed using the Mindi simulation tool can be downloaded to a personal computer or workstation.

### 5.4 Microchip Advanced Part Selector (MAPS)

MAPS is a software tool that helps semiconductor professionals efficiently identify Microchip devices that fit a particular design requirement. Available at no cost from the Microchip website at [www.microchip.com/maps](http://www.microchip.com/maps), the MAPS is an overall selection tool for Microchip's product portfolio that includes Analog, Memory, MCUs and DSCs. Using this tool you can define a filter to sort features for a parametric search of devices and export side-by-side technical comparison reports. Helpful links are also provided for Data sheets, Purchase, and Sampling of Microchip parts.

## 5.5 Analog Demonstration and Evaluation Boards

Microchip offers a broad spectrum of Analog Demonstration and Evaluation Boards that are designed to help you achieve faster time to market. For a complete listing of these boards and their corresponding user's guides and technical information, visit the Microchip web site at [www.microchip.com/analogtools](http://www.microchip.com/analogtools).

Two of our boards that are especially useful are:

- *8-Pin SOIC/MSOP/TSSOP/DIP Evaluation Board, P/N SOIC8EV*
- *14-Pin SOIC/TSSOP/DIP Evaluation Board, P/N SOIC14EV*

## 5.6 Application Notes

The following Microchip Analog Design Note and Application Notes are available on the Microchip web site at [www.microchip.com/appnotes](http://www.microchip.com/appnotes) and are recommended as supplemental reference resources.

- **ADN003:** *"Select the Right Operational Amplifier for your Filtering Circuits"*, DS21821
- **AN722:** *"Operational Amplifier Topologies and DC Specifications"*, DS00722
- **AN723:** *"Operational Amplifier AC Specifications and Applications"*, DS00723
- **AN884:** *"Driving Capacitive Loads With Op Amps"*, DS00884
- **AN990:** *"Analog Sensor Conditioning Circuits – An Overview"*, DS00990

These application notes and others are listed in the design guide:

- *"Signal Chain Design Guide"*, DS21825

# MCP6141/2/3/4

---

NOTES:

## 6.0 PACKAGING INFORMATION

### 6.1 Package Marking Information

5-Lead SOT-23 (MCP6141)



Device	E-Temp Code
MCP6141	ASNN

Note: Applies to 5-Lead SOT-23

Example:



6-Lead SOT-23 (MCP6143)



Device	E-Temp Code
MCP6143	AWNN

Note: Applies to 6-Lead SOT-23

Example:



8-Lead MSOP



Example:

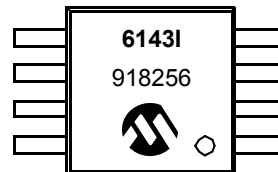

8-Lead PDIP (300 mil)

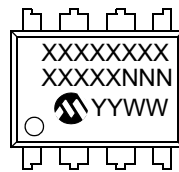

Example:

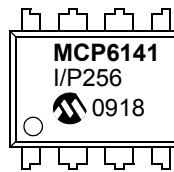

OR

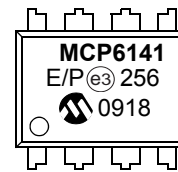

8-Lead SOIC (150 mil)

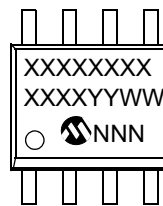

Example:

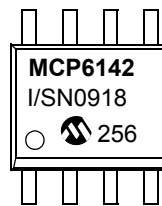

OR

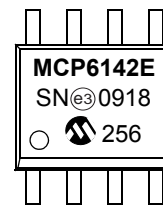

<b>Legend:</b>	XX...X	Customer-specific information
	Y	Year code (last digit of calendar year)
	YY	Year code (last 2 digits of calendar year)
	WW	Week code (week of January 1 is week '01')
	NNN	Alphanumeric traceability code
	(e3)	Pb-free JEDEC designator for Matte Tin (Sn)
	*	This package is Pb-free. The Pb-free JEDEC designator (e3) can be found on the outer packaging for this package.

**Note:** In the event the full Microchip part number cannot be marked on one line, it will be carried over to the next line, thus limiting the number of available characters for customer-specific information.

# MCP6141/2/3/4

## Package Marking Information (Continued)

14-Lead PDIP (300 mil) (MCP6144)

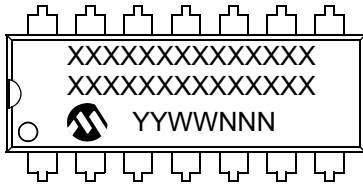

Example:

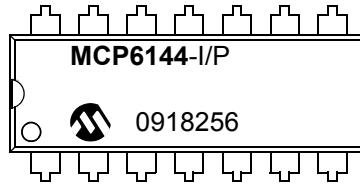

OR

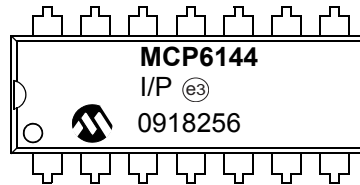

14-Lead SOIC (150 mil) (MCP6144)

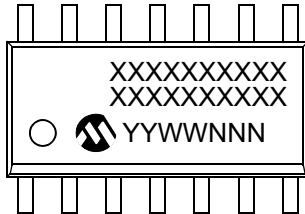

Example:

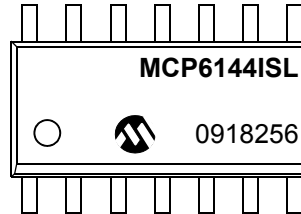

OR

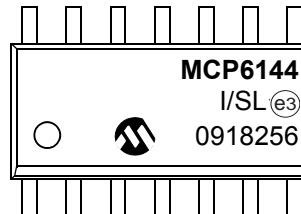

14-Lead TSSOP (MCP6144)

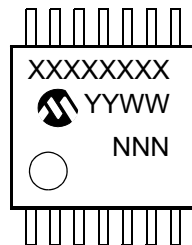

Example:

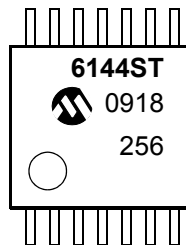

OR

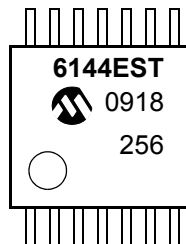



## 5-Lead Plastic Small Outline Transistor (OT) [SOT-23]

**Note:** For the most current package drawings, please see the Microchip Packaging Specification located at <http://www.microchip.com/packaging>



Dimension Limits	Units	MILLIMETERS		
		MIN	NOM	MAX
Number of Pins	N	5		
Lead Pitch	e	0.95 BSC		
Outside Lead Pitch	e1	1.90 BSC		
Overall Height	A	0.90	–	1.45
Molded Package Thickness	A2	0.89	–	1.30
Standoff	A1	0.00	–	0.15
Overall Width	E	2.20	–	3.20
Molded Package Width	E1	1.30	–	1.80
Overall Length	D	2.70	–	3.10
Foot Length	L	0.10	–	0.60
Footprint	L1	0.35	–	0.80
Foot Angle	$\phi$	0°	–	30°
Lead Thickness	c	0.08	–	0.26
Lead Width	b	0.20	–	0.51

**Notes:**

- Dimensions D and E1 do not include mold flash or protrusions. Mold flash or protrusions shall not exceed 0.127 mm per side.
- Dimensioning and tolerancing per ASME Y14.5M.

BSC: Basic Dimension. Theoretically exact value shown without tolerances.

Microchip Technology Drawing C04-091B

# MCP6141/2/3/4

## 6-Lead Plastic Small Outline Transistor (CH) [SOT-23]

**Note:** For the most current package drawings, please see the Microchip Packaging Specification located at <http://www.microchip.com/packaging>



Dimension Limits	Units	MILLIMETERS		
		MIN	NOM	MAX
Number of Pins	N	6		
Pitch	e	0.95 BSC		
Outside Lead Pitch	e1	1.90 BSC		
Overall Height	A	0.90	–	1.45
Molded Package Thickness	A2	0.89	–	1.30
Standoff	A1	0.00	–	0.15
Overall Width	E	2.20	–	3.20
Molded Package Width	E1	1.30	–	1.80
Overall Length	D	2.70	–	3.10
Foot Length	L	0.10	–	0.60
Footprint	L1	0.35	–	0.80
Foot Angle	$\phi$	0°	–	30°
Lead Thickness	c	0.08	–	0.26
Lead Width	b	0.20	–	0.51

**Notes:**

- Dimensions D and E1 do not include mold flash or protrusions. Mold flash or protrusions shall not exceed 0.127 mm per side.
- Dimensioning and tolerancing per ASME Y14.5M.

BSC: Basic Dimension. Theoretically exact value shown without tolerances.

Microchip Technology Drawing C04-028B

## 8-Lead Plastic Micro Small Outline Package (MS) [MSOP]

**Note:** For the most current package drawings, please see the Microchip Packaging Specification located at <http://www.microchip.com/packaging>

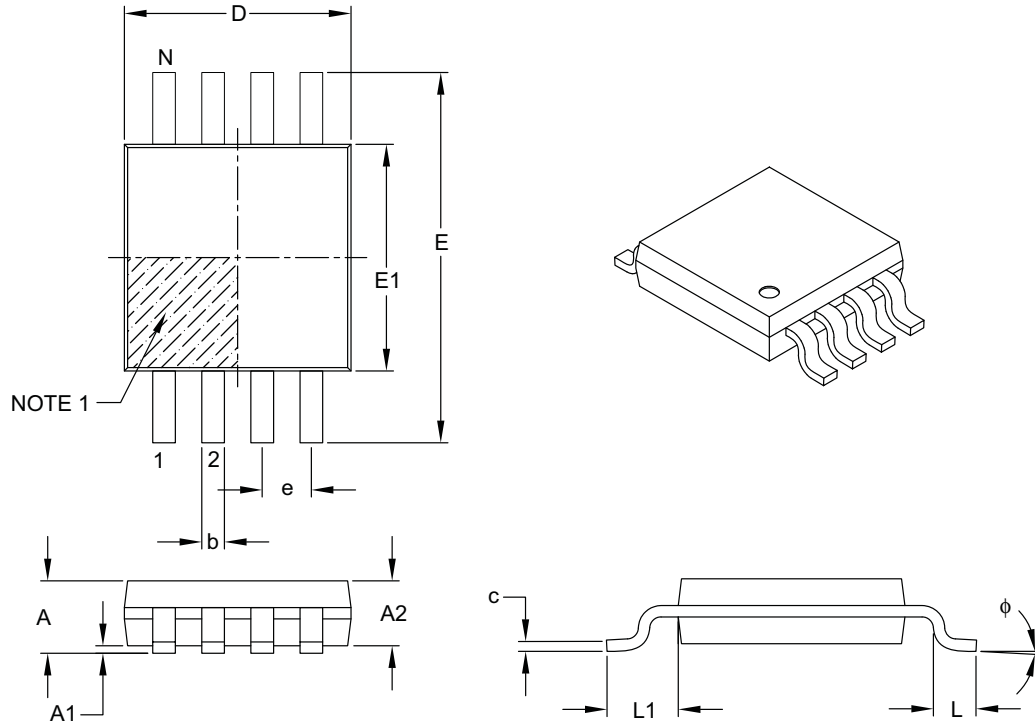

Dimension Limits	Units	MILLIMETERS		
		MIN	NOM	MAX
Number of Pins	N	8		
Pitch	e	0.65 BSC		
Overall Height	A	–	–	1.10
Molded Package Thickness	A2	0.75	0.85	0.95
Standoff	A1	0.00	–	0.15
Overall Width	E	4.90 BSC		
Molded Package Width	E1	3.00 BSC		
Overall Length	D	3.00 BSC		
Foot Length	L	0.40	0.60	0.80
Footprint	L1	0.95 REF		
Foot Angle	$\phi$	0°	–	8°
Lead Thickness	c	0.08	–	0.23
Lead Width	b	0.22	–	0.40

**Notes:**

- Pin 1 visual index feature may vary, but must be located within the hatched area.
- Dimensions D and E1 do not include mold flash or protrusions. Mold flash or protrusions shall not exceed 0.15 mm per side.
- Dimensioning and tolerancing per ASME Y14.5M.

BSC: Basic Dimension. Theoretically exact value shown without tolerances.

REF: Reference Dimension, usually without tolerance, for information purposes only.

Microchip Technology Drawing C04-111B

# MCP6141/2/3/4

## 8-Lead Plastic Dual In-Line (P) – 300 mil Body [PDIP]

**Note:** For the most current package drawings, please see the Microchip Packaging Specification located at <http://www.microchip.com/packageing>



Dimension Limits	Units	INCHES		
		MIN	NOM	MAX
Number of Pins	N	8		
Pitch	e	.100 BSC		
Top to Seating Plane	A	–	–	.210
Molded Package Thickness	A2	.115	.130	.195
Base to Seating Plane	A1	.015	–	–
Shoulder to Shoulder Width	E	.290	.310	.325
Molded Package Width	E1	.240	.250	.280
Overall Length	D	.348	.365	.400
Tip to Seating Plane	L	.115	.130	.150
Lead Thickness	c	.008	.010	.015
Upper Lead Width	b1	.040	.060	.070
Lower Lead Width	b	.014	.018	.022
Overall Row Spacing §	eB	–	–	.430

**Notes:**

- Pin 1 visual index feature may vary, but must be located with the hatched area.
- § Significant Characteristic.
- Dimensions D and E1 do not include mold flash or protrusions. Mold flash or protrusions shall not exceed .010" per side.
- Dimensioning and tolerancing per ASME Y14.5M.

BSC: Basic Dimension. Theoretically exact value shown without tolerances.

Microchip Technology Drawing C04-018B

## 14-Lead Plastic Dual In-Line (P) – 300 mil Body [PDIP]

**Note:** For the most current package drawings, please see the Microchip Packaging Specification located at <http://www.microchip.com/packaging>



Dimension Limits	Units	INCHES		
		MIN	NOM	MAX
Number of Pins	N	14		
Pitch	e	.100 BSC		
Top to Seating Plane	A	–	–	.210
Molded Package Thickness	A2	.115	.130	.195
Base to Seating Plane	A1	.015	–	–
Shoulder to Shoulder Width	E	.290	.310	.325
Molded Package Width	E1	.240	.250	.280
Overall Length	D	.735	.750	.775
Tip to Seating Plane	L	.115	.130	.150
Lead Thickness	c	.008	.010	.015
Upper Lead Width	b1	.045	.060	.070
Lower Lead Width	b	.014	.018	.022
Overall Row Spacing §	eB	–	–	.430

**Notes:**

1. Pin 1 visual index feature may vary, but must be located with the hatched area.
2. § Significant Characteristic.
3. Dimensions D and E1 do not include mold flash or protrusions. Mold flash or protrusions shall not exceed .010" per side.
4. Dimensioning and tolerancing per ASME Y14.5M.

BSC: Basic Dimension. Theoretically exact value shown without tolerances.

Microchip Technology Drawing C04-005B

# MCP6141/2/3/4

## 8-Lead Plastic Small Outline (SN) – Narrow, 3.90 mm Body [SOIC]

**Note:** For the most current package drawings, please see the Microchip Packaging Specification located at <http://www.microchip.com/packaging>



Dimension Limits	Units	MILLIMETERS		
		MIN	NOM	MAX
Number of Pins	N	8		
Pitch	e	1.27 BSC		
Overall Height	A	–	–	1.75
Molded Package Thickness	A2	1.25	–	–
Standoff §	A1	0.10	–	0.25
Overall Width	E	6.00 BSC		
Molded Package Width	E1	3.90 BSC		
Overall Length	D	4.90 BSC		
Chamfer (optional)	h	0.25	–	0.50
Foot Length	L	0.40	–	1.27
Footprint	L1	1.04 REF		
Foot Angle	$\phi$	0°	–	8°
Lead Thickness	c	0.17	–	0.25
Lead Width	b	0.31	–	0.51
Mold Draft Angle Top	$\alpha$	5°	–	15°
Mold Draft Angle Bottom	$\beta$	5°	–	15°

**Notes:**

- Pin 1 visual index feature may vary, but must be located within the hatched area.
- § Significant Characteristic.
- Dimensions D and E1 do not include mold flash or protrusions. Mold flash or protrusions shall not exceed 0.15 mm per side.
- Dimensioning and tolerancing per ASME Y14.5M.

BSC: Basic Dimension. Theoretically exact value shown without tolerances.

REF: Reference Dimension, usually without tolerance, for information purposes only.

Microchip Technology Drawing C04-057B

## 14-Lead Plastic Small Outline (SL) – Narrow, 3.90 mm Body [SOIC]

**Note:** For the most current package drawings, please see the Microchip Packaging Specification located at <http://www.microchip.com/packaging>



		Units	MILLIMETERS		
Dimension Limits			MIN	NOM	MAX
Number of Pins	N		14		
Pitch	e		1.27 BSC		
Overall Height	A		–	–	1.75
Molded Package Thickness	A2		1.25	–	–
Standoff §	A1		0.10	–	0.25
Overall Width	E		6.00 BSC		
Molded Package Width	E1		3.90 BSC		
Overall Length	D		8.65 BSC		
Chamfer (optional)	h		0.25	–	0.50
Foot Length	L		0.40	–	1.27
Footprint	L1		1.04 REF		
Foot Angle	φ		0°	–	8°
Lead Thickness	c		0.17	–	0.25
Lead Width	b		0.31	–	0.51
Mold Draft Angle Top	α		5°	–	15°
Mold Draft Angle Bottom	β		5°	–	15°

**Notes:**

- Pin 1 visual index feature may vary, but must be located within the hatched area.
- § Significant Characteristic.
- Dimensions D and E1 do not include mold flash or protrusions. Mold flash or protrusions shall not exceed 0.15 mm per side.
- Dimensioning and tolerancing per ASME Y14.5M.

BSC: Basic Dimension. Theoretically exact value shown without tolerances.

REF: Reference Dimension, usually without tolerance, for information purposes only.

Microchip Technology Drawing C04-065B

# MCP6141/2/3/4

## 14-Lead Plastic Thin Shrink Small Outline (ST) – 4.4 mm Body [TSSOP]

**Note:** For the most current package drawings, please see the Microchip Packaging Specification located at <http://www.microchip.com/packaging>



Dimension Limits	Units	MILLIMETERS		
		MIN	NOM	MAX
Number of Pins	N	14		
Pitch	e	0.65 BSC		
Overall Height	A	–	–	1.20
Molded Package Thickness	A2	0.80	1.00	1.05
Standoff	A1	0.05	–	0.15
Overall Width	E	6.40 BSC		
Molded Package Width	E1	4.30	4.40	4.50
Molded Package Length	D	4.90	5.00	5.10
Foot Length	L	0.45	0.60	0.75
Footprint	L1	1.00 REF		
Foot Angle	φ	0°	–	8°
Lead Thickness	c	0.09	–	0.20
Lead Width	b	0.19	–	0.30

**Notes:**

- Pin 1 visual index feature may vary, but must be located within the hatched area.
- Dimensions D and E1 do not include mold flash or protrusions. Mold flash or protrusions shall not exceed 0.15 mm per side.
- Dimensioning and tolerancing per ASME Y14.5M.

BSC: Basic Dimension. Theoretically exact value shown without tolerances.

REF: Reference Dimension, usually without tolerance, for information purposes only.

Microchip Technology Drawing C04-087B



## APPENDIX A: REVISION HISTORY

### Revision D (May 2009)

The following is the list of modifications:

1. **DC Electrical Characteristics** table: Corrected formatting issue in Output section.
2. **AC Electrical Characteristics** table: Slew Rate - changed typical value from 3.0 to 24. Changed Phase Margin from 65 to 60. Changed Phase Margin Condition from G=+1 to G=+10 V/V.
3. Updated Package Outline Drawings
4. Updated Revision History.

### Revision C (December 2007)

- Updated Figures 2.4 and 2.5
- Expanded Analog Input Absolute Max Voltage Range (applies retroactively)
- Expanded maximum operating  $V_{DD}$  (going forward)
- **Section 1.0 “Electrical Characteristics”** updated
- **Section 2.0 “Typical Performance Curves”** updated
- **Section 4.0 “Applications Information”**
  - Updated input stage explanation
- **Section 5.0 “Design Aids”** updated

### Revision B (November 2005)

The following is the list of modifications:

1. Added the following:
  - a) SOT-23-5 package for the MCP6141 single op amps.
  - b) SOT-23-6 package for the MCP6143 single op amps with Chip Select.
  - c) Extended Temperature (-40°C to +125°C) op amps.
2. Updated specifications in **Section 1.0 “Electrical Characteristics”** for E-temp parts.
3. Corrected and updated plots in **Section 2.0 “Typical Performance Curves”**.
4. Added **Section 3.0 “Pin Descriptions”**.
5. Updated **Section 4.0 “Applications Information”** and added section on unused op amps.
6. Updated **Section 5.0 “Design Aids”** to include FilterLab.
7. Added SOT-23-5 and SOT-23-6 packages and corrected package marking information in **Section 6.0 “Packaging Information”**.
8. Added **Appendix A: “Revision History”**.

### Revision A (September 2002)

- Original Release of this Document.

# MCP6141/2/3/4

---

NOTES:

## PRODUCT IDENTIFICATION SYSTEM

To order or obtain information, e.g., on pricing or delivery, refer to the factory or the listed sales office.

<u>PART NO.</u>	<u>- X</u>	<u>/ XX</u>	
 Device	 Temperature Range	 Package	
<b>Examples:</b>			
a) MCP6141-I/P:	Industrial Temperature	8 lead PDIP package.	
b) MCP6141T-E/OT:	Tape and Reel, Extended Temperature	5 lead SOT-23 package.	
a) MCP6142-I/SN:	Industrial Temperature	8 lead SOIC package.	
b) MCP6142T-E/MS:	Tape and Reel, Extended Temperature	8 lead MSOP package.	
a) MCP6143-I/P:	Industrial Temperature,	8 lead PDIP package.	
b) MCP6143T-E/CH:	Tape and Reel, Extended Temperature	6 lead SOT-23 package.	
a) MCP6144-I/SL:	Industrial Temperature	14 lead PDIP package.	
b) MCP6144T-E/ST:	Tape and Reel, Extended Temperature	14 lead TSSOP package.	
<b>Device:</b>			
MCP6141:	Single Op Amp		
MCP6141T:	Single Op Amp (Tape and Reel for SOT-23, SOIC, MSOP)		
MCP6142:	Dual Op Amp		
MCP6142T:	Dual Op Amp (Tape and Reel for SOIC and MSOP)		
MCP6143:	Single Op Amp w/ $\overline{CS}$		
MCP6143T:	Single Op Amp w/ $\overline{CS}$ (Tape and Reel for SOT-23, SOIC, MSOP)		
MCP6144:	Quad Op Amp		
MCP6144T:	Quad Op Amp (Tape and Reel for SOIC and TSSOP)		
<b>Temperature Range:</b>			
I	= -40°C to +85°C (industrial)		
E	= -40°C to +125°C (extended)		
<b>Package:</b>			
CH	= Plastic Small Outline Transistor (SOT-23), 6-lead (Tape and Reel - MCP6143 only)		
MS	= Plastic Micro Small Outline (MSOP), 8-lead		
OT	= Plastic Small Outline Transistor (SOT-23), 5-lead (Tape and Reel - MCP6141 only)		
P	= Plastic DIP (300 mil body), 8-lead, 14-lead		
SL	= Plastic SOIC (3.9 mm body), 14-lead		
SN	= Plastic SOIC (3.9 mm body), 8-lead		
ST	= Plastic TSSOP (4.4 mm body), 14-lead		

# MCP6141/2/3/4

---

NOTES:

---

**Note the following details of the code protection feature on Microchip devices:**

- Microchip products meet the specification contained in their particular Microchip Data Sheet.
- Microchip believes that its family of products is one of the most secure families of its kind on the market today, when used in the intended manner and under normal conditions.
- There are dishonest and possibly illegal methods used to breach the code protection feature. All of these methods, to our knowledge, require using the Microchip products in a manner outside the operating specifications contained in Microchip's Data Sheets. Most likely, the person doing so is engaged in theft of intellectual property.
- Microchip is willing to work with the customer who is concerned about the integrity of their code.
- Neither Microchip nor any other semiconductor manufacturer can guarantee the security of their code. Code protection does not mean that we are guaranteeing the product as “unbreakable.”

Code protection is constantly evolving. We at Microchip are committed to continuously improving the code protection features of our products. Attempts to break Microchip's code protection feature may be a violation of the Digital Millennium Copyright Act. If such acts allow unauthorized access to your software or other copyrighted work, you may have a right to sue for relief under that Act.

---

Information contained in this publication regarding device applications and the like is provided only for your convenience and may be superseded by updates. It is your responsibility to ensure that your application meets with your specifications. MICROCHIP MAKES NO REPRESENTATIONS OR WARRANTIES OF ANY KIND WHETHER EXPRESS OR IMPLIED, WRITTEN OR ORAL, STATUTORY OR OTHERWISE, RELATED TO THE INFORMATION, INCLUDING BUT NOT LIMITED TO ITS CONDITION, QUALITY, PERFORMANCE, MERCHANTABILITY OR FITNESS FOR PURPOSE. Microchip disclaims all liability arising from this information and its use. Use of Microchip devices in life support and/or safety applications is entirely at the buyer's risk, and the buyer agrees to defend, indemnify and hold harmless Microchip from any and all damages, claims, suits, or expenses resulting from such use. No licenses are conveyed, implicitly or otherwise, under any Microchip intellectual property rights.

**Trademarks**

The Microchip name and logo, the Microchip logo, Accuron, dsPIC, KEELOQ, KEELOQ logo, MPLAB, PIC, PICmicro, PICSTART, rfPIC, SmartShunt and UNI/O are registered trademarks of Microchip Technology Incorporated in the U.S.A. and other countries.

FilterLab, Hampshire, Linear Active Thermistor, MXDEV, MXLAB, SEEVAL, SmartSensor and The Embedded Control Solutions Company are registered trademarks of Microchip Technology Incorporated in the U.S.A.

Analog-for-the-Digital Age, Application Maestro, CodeGuard, dsPICDEM, dsPICDEM.net, dsPICworks, dsSPEAK, ECAN, ECONOMONITOR, FanSense, In-Circuit Serial Programming, ICSP, ICEPIC, Mindi, MiWi, MPASM, MPLAB Certified logo, MPLIB, MPLINK, mTouch, nanoWatt XLP, PICkit, PICDEM, PICDEM.net, PICtail, PIC<sup>32</sup> logo, PowerCal, PowerInfo, PowerMate, PowerTool, REAL ICE, rfLAB, Select Mode, Total Endurance, TSHARC, WiperLock and ZENA are trademarks of Microchip Technology Incorporated in the U.S.A. and other countries.

SQTP is a service mark of Microchip Technology Incorporated in the U.S.A.

All other trademarks mentioned herein are property of their respective companies.

© 2009, Microchip Technology Incorporated, Printed in the U.S.A., All Rights Reserved.

 Printed on recycled paper.

**QUALITY MANAGEMENT SYSTEM**  
**CERTIFIED BY DNV**  
**== ISO/TS 16949:2002 ==**

*Microchip received ISO/TS-16949:2002 certification for its worldwide headquarters, design and wafer fabrication facilities in Chandler and Tempe, Arizona; Gresham, Oregon and design centers in California and India. The Company's quality system processes and procedures are for its PIC® MCUs and dsPIC® DSCs, KEELOQ® code hopping devices, Serial EEPROMs, microperipherals, nonvolatile memory and analog products. In addition, Microchip's quality system for the design and manufacture of development systems is ISO 9001:2000 certified.*



---

---

## WORLDWIDE SALES AND SERVICE

---

---

### AMERICAS

**Corporate Office**  
2355 West Chandler Blvd.  
Chandler, AZ 85224-6199  
Tel: 480-792-7200  
Fax: 480-792-7277  
Technical Support:  
<http://support.microchip.com>  
Web Address:  
[www.microchip.com](http://www.microchip.com)

**Atlanta**  
Duluth, GA  
Tel: 678-957-9614  
Fax: 678-957-1455

**Boston**  
Westborough, MA  
Tel: 774-760-0087  
Fax: 774-760-0088

**Chicago**  
Itasca, IL  
Tel: 630-285-0071  
Fax: 630-285-0075

**Cleveland**  
Independence, OH  
Tel: 216-447-0464  
Fax: 216-447-0643

**Dallas**  
Addison, TX  
Tel: 972-818-7423  
Fax: 972-818-2924

**Detroit**  
Farmington Hills, MI  
Tel: 248-538-2250  
Fax: 248-538-2260

**Kokomo**  
Kokomo, IN  
Tel: 765-864-8360  
Fax: 765-864-8387

**Los Angeles**  
Mission Viejo, CA  
Tel: 949-462-9523  
Fax: 949-462-9608

**Santa Clara**  
Santa Clara, CA  
Tel: 408-961-6444  
Fax: 408-961-6445

**Toronto**  
Mississauga, Ontario,  
Canada  
Tel: 905-673-0699  
Fax: 905-673-6509

### ASIA/PACIFIC

**Asia Pacific Office**  
Suites 3707-14, 37th Floor  
Tower 6, The Gateway  
Harbour City, Kowloon  
Hong Kong  
Tel: 852-2401-1200  
Fax: 852-2401-3431

**Australia - Sydney**  
Tel: 61-2-9868-6733  
Fax: 61-2-9868-6755

**China - Beijing**  
Tel: 86-10-8528-2100  
Fax: 86-10-8528-2104

**China - Chengdu**  
Tel: 86-28-8665-5511  
Fax: 86-28-8665-7889

**China - Hong Kong SAR**  
Tel: 852-2401-1200  
Fax: 852-2401-3431

**China - Nanjing**  
Tel: 86-25-8473-2460  
Fax: 86-25-8473-2470

**China - Qingdao**  
Tel: 86-532-8502-7355  
Fax: 86-532-8502-7205

**China - Shanghai**  
Tel: 86-21-5407-5533  
Fax: 86-21-5407-5066

**China - Shenyang**  
Tel: 86-24-2334-2829  
Fax: 86-24-2334-2393

**China - Shenzhen**  
Tel: 86-755-8203-2660  
Fax: 86-755-8203-1760

**China - Wuhan**  
Tel: 86-27-5980-5300  
Fax: 86-27-5980-5118

**China - Xiamen**  
Tel: 86-592-2388138  
Fax: 86-592-2388130

**China - Xian**  
Tel: 86-29-8833-7252  
Fax: 86-29-8833-7256

**China - Zhuhai**  
Tel: 86-756-3210040  
Fax: 86-756-3210049

### ASIA/PACIFIC

**India - Bangalore**  
Tel: 91-80-3090-4444  
Fax: 91-80-3090-4080

**India - New Delhi**  
Tel: 91-11-4160-8631  
Fax: 91-11-4160-8632

**India - Pune**  
Tel: 91-20-2566-1512  
Fax: 91-20-2566-1513

**Japan - Yokohama**  
Tel: 81-45-471- 6166  
Fax: 81-45-471-6122

**Korea - Daegu**  
Tel: 82-53-744-4301  
Fax: 82-53-744-4302

**Korea - Seoul**  
Tel: 82-2-554-7200  
Fax: 82-2-558-5932 or  
82-2-558-5934

**Malaysia - Kuala Lumpur**  
Tel: 60-3-6201-9857  
Fax: 60-3-6201-9859

**Malaysia - Penang**  
Tel: 60-4-227-8870  
Fax: 60-4-227-4068

**Philippines - Manila**  
Tel: 63-2-634-9065  
Fax: 63-2-634-9069

**Singapore**  
Tel: 65-6334-8870  
Fax: 65-6334-8850

**Taiwan - Hsin Chu**  
Tel: 886-3-6578-300  
Fax: 886-3-6578-370

**Taiwan - Kaohsiung**  
Tel: 886-7-536-4818  
Fax: 886-7-536-4803

**Taiwan - Taipei**  
Tel: 886-2-2500-6610  
Fax: 886-2-2508-0102

**Thailand - Bangkok**  
Tel: 66-2-694-1351  
Fax: 66-2-694-1350

### EUROPE

**Austria - Wels**  
Tel: 43-7242-2244-39  
Fax: 43-7242-2244-393

**Denmark - Copenhagen**  
Tel: 45-4450-2828  
Fax: 45-4485-2829

**France - Paris**  
Tel: 33-1-69-53-63-20  
Fax: 33-1-69-30-90-79

**Germany - Munich**  
Tel: 49-89-627-144-0  
Fax: 49-89-627-144-44

**Italy - Milan**  
Tel: 39-0331-742611  
Fax: 39-0331-466781

**Netherlands - Drunen**  
Tel: 31-416-690399  
Fax: 31-416-690340

**Spain - Madrid**  
Tel: 34-91-708-08-90  
Fax: 34-91-708-08-91

**UK - Wokingham**  
Tel: 44-118-921-5869  
Fax: 44-118-921-5820

03/26/09

Компания «Океан Электроники» предлагает заключение долгосрочных отношений при поставках импортных электронных компонентов на взаимовыгодных условиях!

Наши преимущества:

- Поставка оригинальных импортных электронных компонентов напрямую с производств Америки, Европы и Азии, а так же с крупнейших складов мира;
- Широкая линейка поставок активных и пассивных импортных электронных компонентов (более 30 млн. наименований);
- Поставка сложных, дефицитных, либо снятых с производства позиций;
- Оперативные сроки поставки под заказ (от 5 рабочих дней);
- Экспресс доставка в любую точку России;
- Помощь Конструкторского Отдела и консультации квалифицированных инженеров;
- Техническая поддержка проекта, помощь в подборе аналогов, поставка прототипов;
- Поставка электронных компонентов под контролем ВП;
- Система менеджмента качества сертифицирована по Международному стандарту ISO 9001;
- При необходимости вся продукция военного и аэрокосмического назначения проходит испытания и сертификацию в лаборатории (по согласованию с заказчиком);
- Поставка специализированных компонентов военного и аэрокосмического уровня качества (Xilinx, Altera, Analog Devices, Intersil, Interpoint, Microsemi, Actel, Aeroflex, Peregrine, VPT, Syfer, Eurofarad, Texas Instruments, MS Kennedy, Miteq, Cobham, E2V, MA-COM, Hittite, Mini-Circuits, General Dynamics и др.);

Компания «Океан Электроники» является официальным дистрибьютором и эксклюзивным представителем в России одного из крупнейших производителей разъемов военного и аэрокосмического назначения «JONHON», а так же официальным дистрибьютором и эксклюзивным представителем в России производителя высокотехнологичных и надежных решений для передачи СВЧ сигналов «FORSTAR».



## JONHON

«JONHON» (основан в 1970 г.)

Разъемы специального, военного и аэрокосмического назначения:

(Применяются в военной, авиационной, аэрокосмической, морской, железнодорожной, горно- и нефтедобывающей отраслях промышленности)

«FORSTAR» (основан в 1998 г.)

ВЧ соединители, коаксиальные кабели, кабельные сборки и микроволновые компоненты:

(Применяются в телекоммуникациях гражданского и специального назначения, в средствах связи, РЛС, а так же военной, авиационной и аэрокосмической отраслях промышленности).



Телефон: 8 (812) 309-75-97 (многоканальный)

Факс: 8 (812) 320-03-32

Электронная почта: [ocean@oceanchips.ru](mailto:ocean@oceanchips.ru)

Web: <http://oceanchips.ru/>

Адрес: 198099, г. Санкт-Петербург, ул. Калинина, д. 2, корп. 4, лит. А