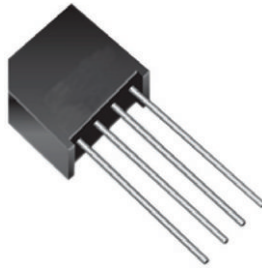

## Single Phase Rectifier Bridge, 1.9 A

**2KBB**

### FEATURES

- Suitable for printed circuit board mounting
- Leads on standard 2.54 mm (0.1") grid
- Compact construction
- High surge current capability
- Polarized package
- Equivalent to standard DIN parts
- Material categorization: for definitions of compliance please see [www.vishay.com/doc?99912](http://www.vishay.com/doc?99912)

**RoHS**  
COMPLIANT

### PRODUCT SUMMARY

$I_O$	1.9 A
$V_{RRM}$	50 V to 1000 V
Package	2KBB
Circuit	Single phase bridge

### DESCRIPTION

A 1.9 A single phase diode bridge rectifier assembly consisting of four silicon diodes in a plastic encapsulation, intended for general applications in industrial and consumer equipment.

### MAJOR RATINGS AND CHARACTERISTICS

SYMBOL	CHARACTERISTICS	VALUES	UNITS
$I_O$		1.9	A
	$T_C$	45	°C
$I_{FSM}$	50 Hz	50	A
	60 Hz	52	
$I^2t$	50 Hz	17.7	A <sup>2</sup> s
	60 Hz	16.1	
$V_{RRM}$		100 to 1000	V
$T_J$		-40 to 150	°C

### ELECTRICAL SPECIFICATIONS

#### VOLTAGE RATINGS AND APPLICATION DATA

CROSS REFERENCE		$V_{RRM}, V_{RSM}$ MAXIMUM PEAK REVERSE VOLTAGE $T_J = 15\text{ °C}$ (V)	$I_{RM}$ TYPICAL PEAK REVERSE CURRENT PER DIODE AT RATED $V_{RRM}$ ( $\mu$ A)		APPLICATION DATA (SEE FIGURE 3)		
PART NUMBER	DIN CODE		$T_J = 25\text{ °C}$	$T_J = 150\text{ °C}$	$V_{RMS}$ MAXIMUM RECOMMENDE D AC SUPPLY VOLTAGE (V)	$C_{MAX}$ MAXIMUM LOAD CAPACITANCE ( $\mu$ F)	$R_{MIN}$ MINIMUM SOURCE RESISTANCE ( $\Omega$ )
VS-2KBB05	B20C1500	50	10	500	20	7000	0.3
VS-2KBB10	B40C1500	100	10	500	40	5000	0.5
VS-2KBB20	B80C1500	200	10	500	80	3300	0.8
VS-2KBB40	B125C1500	400	10	500	125	1600	1.5
VS-2KBB60	B250C1500	600	10	500	250	1200	2.5
VS-2KBB80	B380C1500	800	10	500	380	800	3.0
VS-2KBB100	B500C1500	1000	10	500	500	600	5.0

#### Note

- For PIN configuration - ~ ~ + add "R" to end of part number, e.g. 2KBB05R (see also dimensions for details - link at the end of datasheet)

FORWARD CONDUCTION					
PARAMETER	SYMBOL	TEST CONDITIONS		VALUES	UNITS
Maximum DC output current	$I_O$	$T_C = 45\text{ }^\circ\text{C}$ , resistive and inductive load		1.9	A
		$T_C = 45\text{ }^\circ\text{C}$ , capacitive load		1.5	
Maximum peak one cycle, non-repetitive surge current	$I_{FSM}$	$t = 6\text{ ms}$	Following any rated load condition, and with rated $V_{RRM}$ applied following surge	50	A
		$t = 5\text{ ms}$		52	
Maximum $I^2t$ for fusing, initial $T_J = T_J$ maximum	$I^2t$	$t = 10\text{ ms}$	Rated $V_{RRM}$ applied following surge, initial $T_J = 150\text{ }^\circ\text{C}$	12.5	$\text{A}^2\text{s}$
		$t = 8.3\text{ ms}$		11.3	
		$t = 10\text{ ms}$		17.7	
		$t = 8.3\text{ ms}$		16.1	
Maximum $I^2\sqrt{t}$ capability for fusing	$I^2\sqrt{t}^{(1)}$	$t = 0.1\text{ to }10\text{ ms}$ , $V_{RRM}$ following surge = 0		177	$\text{A}^2\sqrt{\text{s}}$
Maximum peak forward voltage per diode	$V_{FM}$	$I_O = 1.9\text{ A}$ ( $3.0\text{ A}_{pk}$ )		1.1	V
Operating frequency range	$f$			40 to 2000	Hz

**Note**

(1)  $I^2t$  for time  $t_x = I^2\sqrt{t} \times \sqrt{t_x}$

THERMAL AND MECHANICAL SPECIFICATIONS			
PARAMETER	SYMBOL	VALUES	UNITS
Operating junction and storage temperature range	$T_J, T_{Stg}$	-40 to 150	$^\circ\text{C}$
Approximate weight		4	g
		0.14	oz.

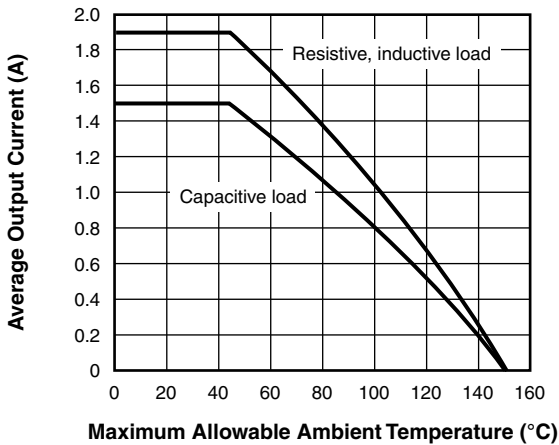

Fig. 1 - Average (DC) Output Current vs. Maximum Allowable Ambient Temperature

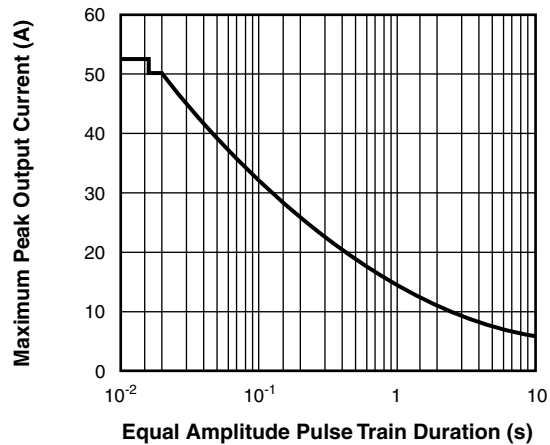

Fig. 2 - Maximum Non-Repetitive Surge Current vs. Pulse Train Duration ( $f = 50\text{ Hz}$ )

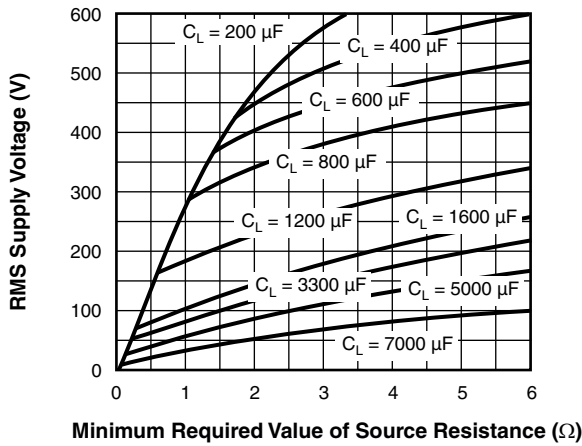

Fig. 3 - Minimum Required Source Resistance vs. RMS Supply Voltage and Load Capacitance

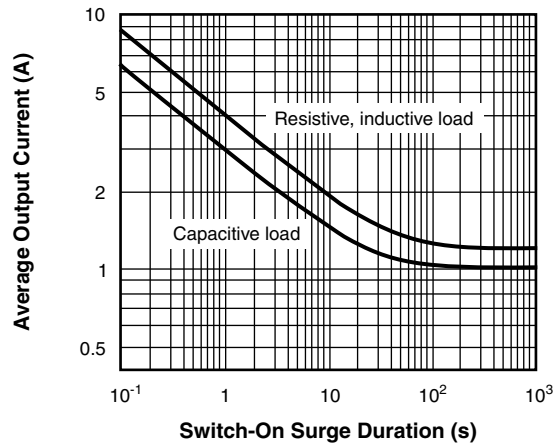
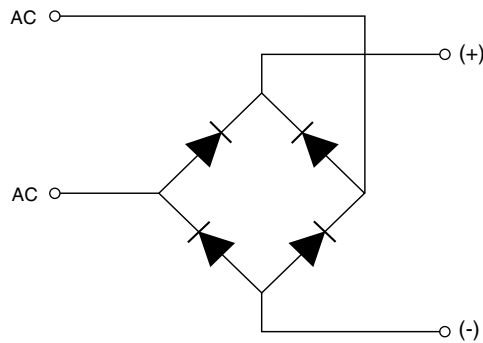

Fig. 4 - Maximum Switch-On Surge Current vs. Surge Duration

**CIRCUIT CONFIGURATION**



LINKS TO RELATED DOCUMENTS	
Dimensions	<a href="http://www.vishay.com/doc?95328">www.vishay.com/doc?95328</a>

## 2KBB

**DIMENSIONS** in millimeters (inches)

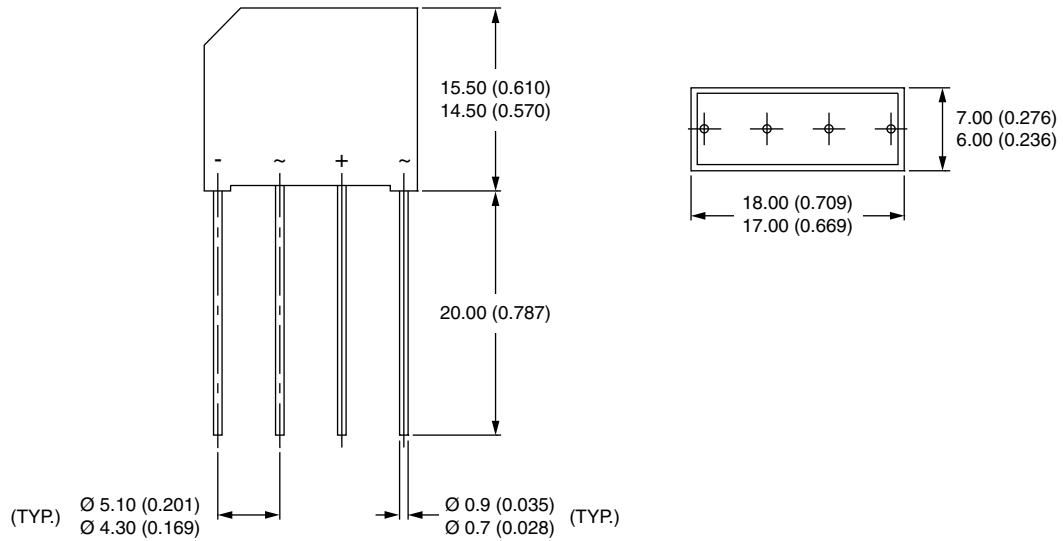

**Note**

- For PIN configuration - ~ ~ + add "R" to end of part number



## Disclaimer

ALL PRODUCT, PRODUCT SPECIFICATIONS AND DATA ARE SUBJECT TO CHANGE WITHOUT NOTICE TO IMPROVE RELIABILITY, FUNCTION OR DESIGN OR OTHERWISE.

Vishay Intertechnology, Inc., its affiliates, agents, and employees, and all persons acting on its or their behalf (collectively, "Vishay"), disclaim any and all liability for any errors, inaccuracies or incompleteness contained in any datasheet or in any other disclosure relating to any product.

Vishay makes no warranty, representation or guarantee regarding the suitability of the products for any particular purpose or the continuing production of any product. To the maximum extent permitted by applicable law, Vishay disclaims (i) any and all liability arising out of the application or use of any product, (ii) any and all liability, including without limitation special, consequential or incidental damages, and (iii) any and all implied warranties, including warranties of fitness for particular purpose, non-infringement and merchantability.

Statements regarding the suitability of products for certain types of applications are based on Vishay's knowledge of typical requirements that are often placed on Vishay products in generic applications. Such statements are not binding statements about the suitability of products for a particular application. It is the customer's responsibility to validate that a particular product with the properties described in the product specification is suitable for use in a particular application. Parameters provided in datasheets and/or specifications may vary in different applications and performance may vary over time. All operating parameters, including typical parameters, must be validated for each customer application by the customer's technical experts. Product specifications do not expand or otherwise modify Vishay's terms and conditions of purchase, including but not limited to the warranty expressed therein.

Except as expressly indicated in writing, Vishay products are not designed for use in medical, life-saving, or life-sustaining applications or for any other application in which the failure of the Vishay product could result in personal injury or death. Customers using or selling Vishay products not expressly indicated for use in such applications do so at their own risk. Please contact authorized Vishay personnel to obtain written terms and conditions regarding products designed for such applications.

No license, express or implied, by estoppel or otherwise, to any intellectual property rights is granted by this document or by any conduct of Vishay. Product names and markings noted herein may be trademarks of their respective owners.

## Material Category Policy

**Vishay Intertechnology, Inc. hereby certifies that all its products that are identified as RoHS-Compliant fulfill the definitions and restrictions defined under Directive 2011/65/EU of The European Parliament and of the Council of June 8, 2011 on the restriction of the use of certain hazardous substances in electrical and electronic equipment (EEE) - recast, unless otherwise specified as non-compliant.**

**Please note that some Vishay documentation may still make reference to RoHS Directive 2002/95/EC. We confirm that all the products identified as being compliant to Directive 2002/95/EC conform to Directive 2011/65/EU.**

**Vishay Intertechnology, Inc. hereby certifies that all its products that are identified as Halogen-Free follow Halogen-Free requirements as per JEDEC JS709A standards. Please note that some Vishay documentation may still make reference to the IEC 61249-2-21 definition. We confirm that all the products identified as being compliant to IEC 61249-2-21 conform to JEDEC JS709A standards.**

Компания «Океан Электроники» предлагает заключение долгосрочных отношений при поставках импортных электронных компонентов на взаимовыгодных условиях!

Наши преимущества:

- Поставка оригинальных импортных электронных компонентов напрямую с производств Америки, Европы и Азии, а так же с крупнейших складов мира;
- Широкая линейка поставок активных и пассивных импортных электронных компонентов (более 30 млн. наименований);
- Поставка сложных, дефицитных, либо снятых с производства позиций;
- Оперативные сроки поставки под заказ (от 5 рабочих дней);
- Экспресс доставка в любую точку России;
- Помощь Конструкторского Отдела и консультации квалифицированных инженеров;
- Техническая поддержка проекта, помощь в подборе аналогов, поставка прототипов;
- Поставка электронных компонентов под контролем ВП;
- Система менеджмента качества сертифицирована по Международному стандарту ISO 9001;
- При необходимости вся продукция военного и аэрокосмического назначения проходит испытания и сертификацию в лаборатории (по согласованию с заказчиком);
- Поставка специализированных компонентов военного и аэрокосмического уровня качества (Xilinx, Altera, Analog Devices, Intersil, Interpoint, Microsemi, Actel, Aeroflex, Peregrine, VPT, Syfer, Eurofarad, Texas Instruments, MS Kennedy, Miteq, Cobham, E2V, MA-COM, Hittite, Mini-Circuits, General Dynamics и др.);

Компания «Океан Электроники» является официальным дистрибьютором и эксклюзивным представителем в России одного из крупнейших производителей разъемов военного и аэрокосмического назначения «JONHON», а так же официальным дистрибьютором и эксклюзивным представителем в России производителя высокотехнологичных и надежных решений для передачи СВЧ сигналов «FORSTAR».



## JONHON

«JONHON» (основан в 1970 г.)

Разъемы специального, военного и аэрокосмического назначения:

(Применяются в военной, авиационной, аэрокосмической, морской, железнодорожной, горно- и нефтедобывающей отраслях промышленности)

«FORSTAR» (основан в 1998 г.)

ВЧ соединители, коаксиальные кабели, кабельные сборки и микроволновые компоненты:

(Применяются в телекоммуникациях гражданского и специального назначения, в средствах связи, РЛС, а так же военной, авиационной и аэрокосмической отраслях промышленности).



Телефон: 8 (812) 309-75-97 (многоканальный)

Факс: 8 (812) 320-03-32

Электронная почта: [ocean@oceanchips.ru](mailto:ocean@oceanchips.ru)

Web: <http://oceanchips.ru/>

Адрес: 198099, г. Санкт-Петербург, ул. Калинина, д. 2, корп. 4, лит. А