

## Object Actuates Switch and Turns Built-in Monitor Indicator ON

- Instantaneous operation upon contact with extremely limited hysteresis for high-precision position detection.
- Detects minute displacement or lightweight objects with minimal operating force.
- Built-in LED indicator ensures easy operation monitoring.
- DC models provide versatile functions in combination with the S3D2 Sensor Controller.



 Be sure to read *Safety Precautions* on page 6 to 7 and *Safety Precautions for All Limit Switches*.

## Application Examples

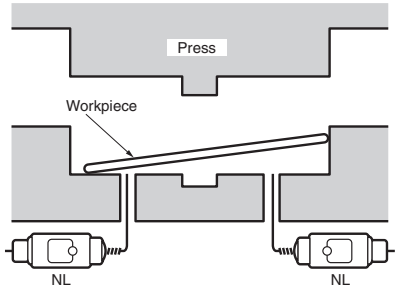
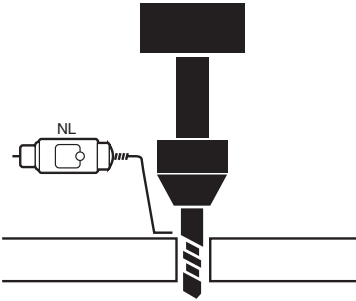
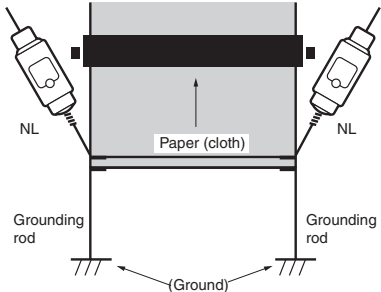
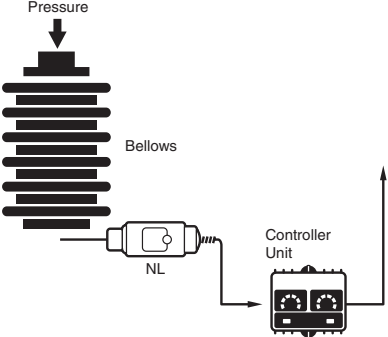
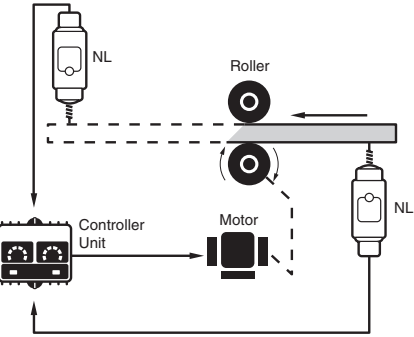
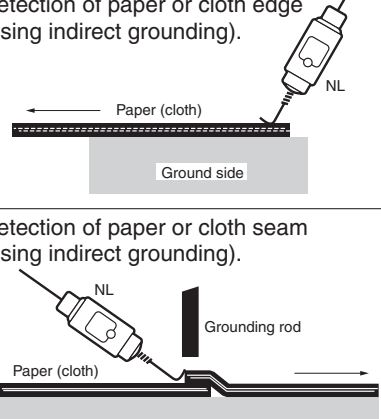
|  |   |  |
|--|---|--|
| <p>· Detection of press completion position.<br/>· Detection of mistakes in workpiece setting or removal.<br/>· Detection of minute workpieces.</p>  | <p>· Drill positioning.<br/>· Material positioning.</p>  | <p>· Detection of workpiece edges.</p>    |
| <p>· Displacement detection and control.</p>   | <p>· Thickness control of rolling plates.</p>            | <p>· Detection of paper or cloth edge (using indirect grounding).<br/>· Detection of paper or cloth seam (using indirect grounding).</p>  |

## Ordering Information

### Built-in Antenna Model

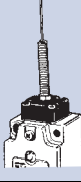
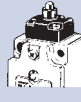
|              |   |   |
|--------------|---|---|
| Model        | Built-in antenna model  |   |
|              | Features  | <ul style="list-style-type: none"> <li>· Provides sufficient OT (overtravel).</li> <li>· Antenna tip withstands bending.</li> </ul> |
| Antenna      | Coil spring   | Plunger   |
|              |  |    |
| Series       | Power supply voltage  | Model   |
| NL1          | 12 VDC  | NL1-C   |
| NL2          | 24 VDC  | NL2-C   |
| NL3          | 100 VAC   | NL3-C 100V  |
|              | 200 VAC   | NL3-C 200V  |
| Antenna only |   | NL1-C ANTENNA ASSY (Same for NL1, NL2, and NL3)   |

Note: Each model is provided with a standard 1-m cable.

### Separate Antenna Model

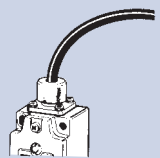
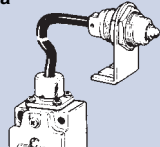
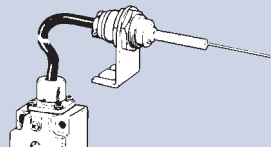
|              |   |   |   |
|--------------|---|---|---|
| Model        | Separate antenna model  |   |   |
|              | Features  | · Antenna with 3-m extension cable is available for narrow spaces where conventional limit switches cannot be used. |   |
| Antenna      | No antenna  | Plunger with antenna  | Coil spring with antenna  |
|              |  |                                   |  |
| Series       | Power supply voltage  | Model   | Model   |
| NL1          | 12 VDC  | NL1-S   | NL1-SP  |
| NL2          | 24 VDC  | NL2-S   | NL2-SP  |
| Antenna only |   | ---   | NL1-SC ANTENNA (Same for NL1 and NL2)   |

Note: Each model is provided with a standard 1-m cable.

## Specifications

| Item                                     | Model | NL1   | NL2   | NL3   |
|--|-------|---|---|---|
| Degree of protection                     |       | IP60  |   |   |
| Supply voltage                           |       | 12 VDC  | 24 VDC  | 100 VAC or 200 VAC  |
| Rated frequency                          |       | ---   |   | 50/60 Hz  |
| Sensitivity                              |       | Grounded object: Contact resistance of 3 kΩ max.<br>Non-grounded object: Antenna-to-ground capacitance of 100 pF min. |   |   |
| Current consumption                      |       | 8 mA  | 15 mA   | ---   |
| Leakage current                          |       | ---   |   | Circuit: 2 mA; Antenna: 1 mA *1   |
| Response time                            |       | 5 ms max.   |   |   |
| Output signal                            |       | Voltage output model: 30 mA at 12 VDC with output impedance of 4.7 kΩ   | Current output model: 24 VDC (directly switching resistive load of 170 mA max.) | Thyristor output model: 100 or 200 VAC (directly switching resistive load of 30 to 300 mA) *2 |
| Insulation resistance                    |       | 0 V (black lead wire) is connected to casing  |   | 100 MΩ min. at 500 VDC *3   |
| Dielectric strength                      |       | 0 V (black lead wire) is connected to casing  |   | 1,500 VAC at 50/60 Hz for 1 min *3  |
| Pollution degree (operating environment) |       | 3 (IEC947-5-1)  |   |   |
| Protection against electric shock        |       | Class II  |   |   |
| Proof tracking index (PTI)               |       | 175   |   |   |
| Switch category                          |       | D (IEC335)  |   |   |
| Vibration resistance                     |       | 10 to 55 Hz, 1.5-mm double amplitude  |   |   |
| Shock resistance                         |       | Approx. 200 m/s <sup>2</sup> min.   |   |   |
| Ambient temperature                      |       | -10°C to +60°C (with no icing)  |   |   |
| Ambient humidity                         |       | 35% to 95%RH  |   |   |
| Weight                                   |       | Approx. 370 g (NL□-C, -P) Approx. 550 g (NL□-S) Approx. 680 g (NL□-SP, -SC)   |   |   |

\*1. The NL3 has a capacitor and resistor for the protection of the built-in SCR. Therefore, the NL3 has leakage current.

\*2. The NL3 requires a current of 30 mA for circuit protection.

If the load current is less than 30 mA, connect the bleeder resistance R in parallel with the load as shown below so that the total current of the load circuit will be 30 to 300 mA. Obtain R from the following formula.

$$R = \frac{V}{30 - I} \text{ (k}\Omega\text{)}$$

Make sure that the permissible power of the resistor is sufficient.

\*3. Between current-carrying and non-current-carrying metal parts

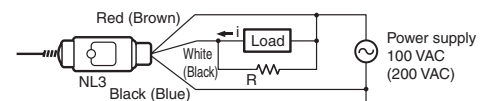

## Structure and Nomenclature

### Nomenclature

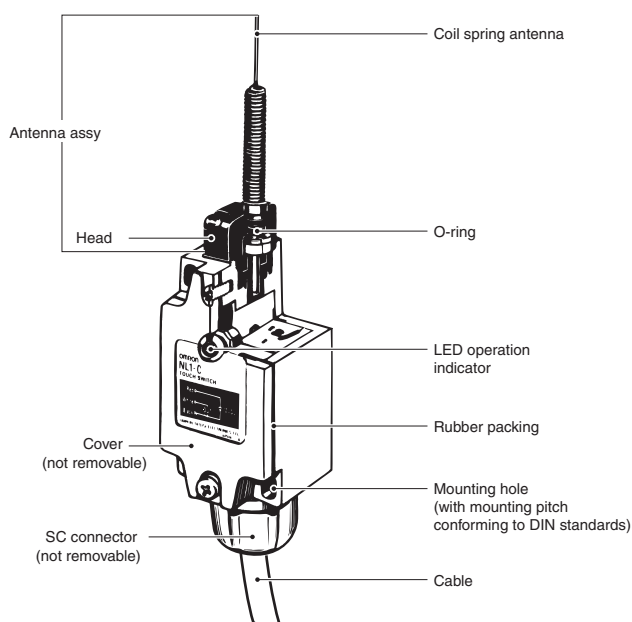

### Principle of Operation

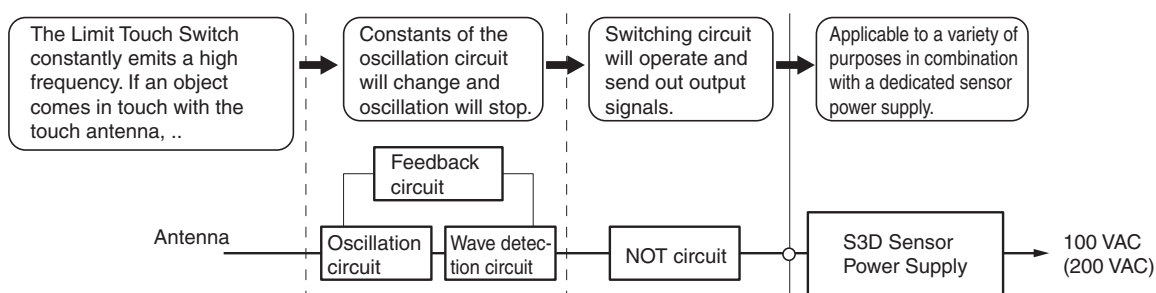

### Classification by Series and Features

#### NL1

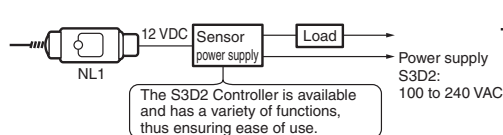

#### NL2

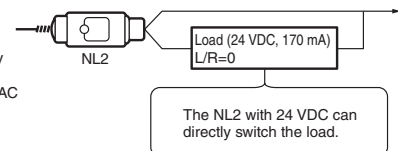

#### NL3

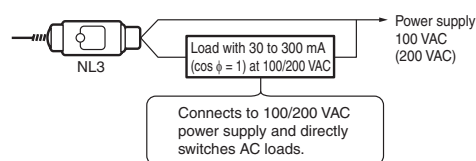

| Applicable model | Sensor Controller | Function                   | Power supply voltage |
|------------------|-------------------|----------------------------|----------------------|
| NL1              | S3D2-AK           | Basic operation            | 100 to 240 VAC       |
|                  | S3D2-BK           | Memory and timer operation |                      |
|                  | S3D2-CK           | Timer operation            |                      |
| NL2              | S3D2-AKD          | Basic operation            | 24 VDC               |
|                  | S3D2-CKD          | Timer operation            |                      |

Contact your OMRON representative for the datasheet of the S3D2.

# Connections

## Output Circuit Diagrams

NL1

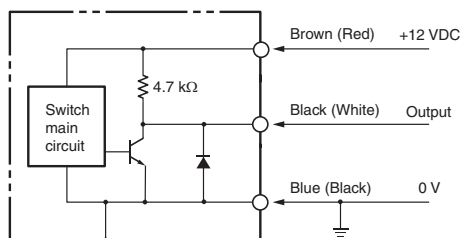

NL2

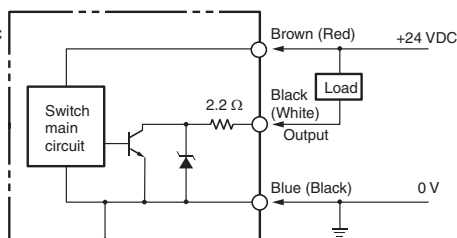

NL3

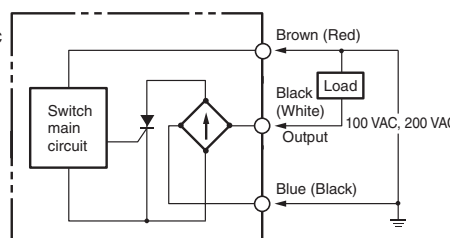

Note: The 0-V power supply side will be connected to the casing if the model is the NL1 or NL2.

## External Connection

### Sensor Power Supply (S3D2)

The use of the S3D2 is recommended for supplying 12 VDC to the NL2 (or 24 VDC to the NL2) and converting the output of the NL into relay or open collector output in versatile timing control. The NL3 does not require a sensor power supply.

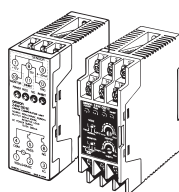

S3D2 Controller Unit

| Applicable model | Sensor Controller | Power supply voltage       |
|------------------|-------------------|----------------------------|
| NL1              | S3D2-AK           | Basic operation            |
|                  | S3D2-BK           | Memory and timer operation |
|                  | S3D2-CK           | Timer operation            |
| NL2              | S3D2-AKD          | Basic operation            |
|                  | S3D2-CKD          | Timer operation            |

Be sure to wire the cable correctly according to the color of each lead wire. Do not wire power lines or high-tension lines alongside the cable.

The use of S3D2 is recommended as a power supply to the NL1. Contact your OMRON representative for the datasheet of the S3D2.

**NL1**

S3D2-AK

**NL2**

\* Ground the blue (black) wire.

A maximum DC load of 170 mA (with no inductance or resistance). Can be switched directly.

**NL3**

\* Be sure to ground the blue (black) line of the NL3.

A maximum AC load of 300 mA (cos φ = 1). Can be switched directly.

- Note: 1. The lead wire colors of the NL have been changed in compliance with the latest applicable JIS standards. Colors in parentheses are previous ones.  
 2. The figures in the S3D2 illustration indicate the terminal numbers of the socket.  
 3. Use a three-conductor cable with a minimum thickness of 0.75 mm to connect the NL and the Sensor Power Supply or other devices with no built-in contacts. The cable can be extended up to 100 m on condition that the cable is wired in an independent conduit.

Dimensions

Built-in Antenna Models

Coil Spring

NL1-C  
NL2-C  
NL3-C

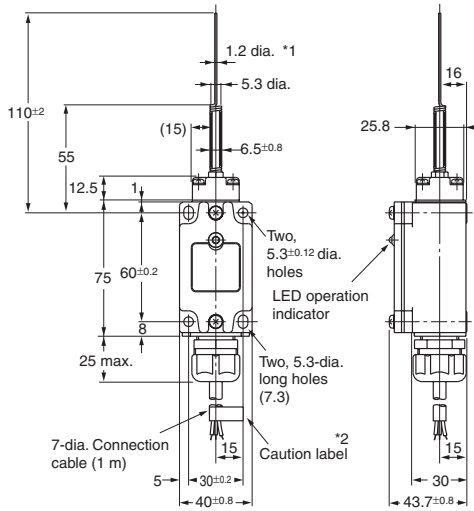
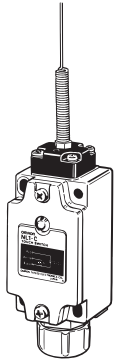

\*1. The coil spring antenna is movable in any direction. Make sure that the angle of the antenna is within 30° to the FP (free position) after the antenna comes into contact with the object.  
\*2. Use after removing the caution label.

Note: 1. The force that pushes the actuator must not exceed 1.96 N.  
2. The antenna is replaceable. Contact your OMRON representative for details.

Plunger

NL1-P  
NL2-P  
NL3-P

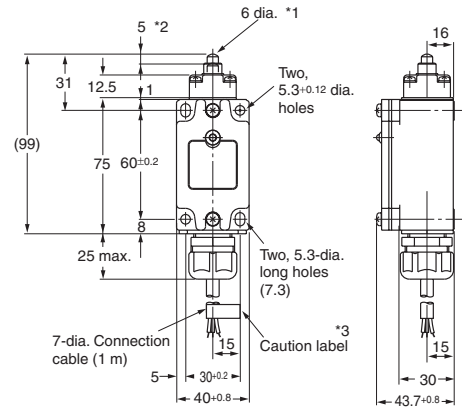

\*1. The stainless-steel plunger antenna allows a maximum OT (overtravel) of 5 mm.  
\*2. This position is the FP (free position) of the plunger.  
\*3. Use after removing the caution label.

Note: Do not apply a force greater than 9.8 N to the plunger.

Separated Antenna Models

The dimensions provided for the NL1-SP, NL2-SP, NL1-SC, and NL2-SC are the external dimensions for the antennas. The casing dimensions of these models are all the same as those for the coil spring or plunger models.

No Antenna

NL1-S  
NL2-S

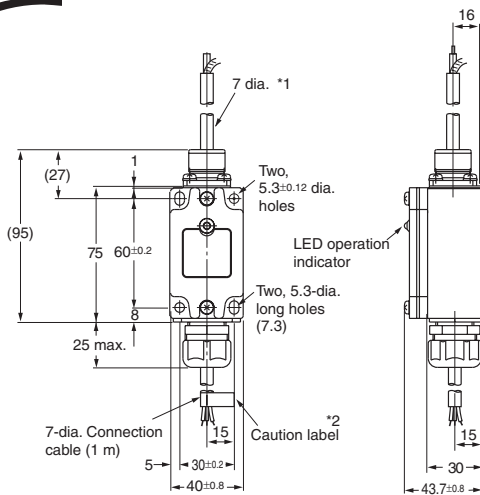
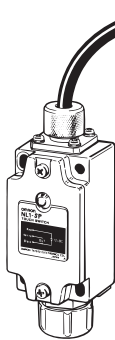

\*1. A standard 3-m high-frequency coaxial cable is provided.  
\*2. Use after removing the caution label.

Note: 1. Make sure that the shape of the antenna is suitable to the application. Use the plunger antenna or coil spring antenna as shown right for the NL1-S or NL2-S.  
2. Do not cut or extend the connecting cable.

Plunger Antenna

NL1-SP  
NL2-SP

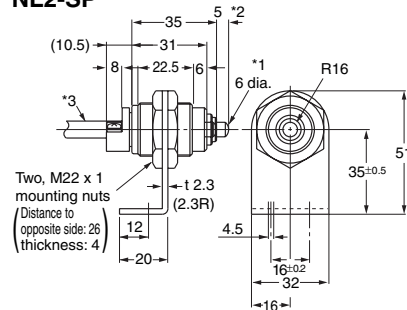
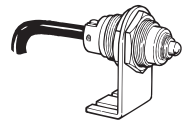

\*1. The stainless-steel plunger antenna allows a maximum OT (overtravel) of 5 mm.  
\*2. This position is the FP (free position) of the plunger.  
\*3. A standard 3-m high-frequency coaxial cable is provided.

Note: 1. Do not apply a force greater than 9.8 N to the plunger.  
2. Do not cut or extend the connecting cable.

Coil Spring Antenna

NL1-SC  
NL2-SC

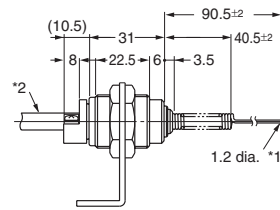
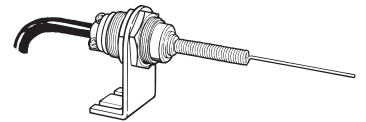

\*1. The coil spring antenna is movable in any direction. Make sure that the angle of the antenna is within 30° to the FP (free position) after the antenna comes into contact with the object.  
\*2. A standard 3-m high-frequency coaxial cable is provided.

Note: 1. Do not cut or extend the connecting cable.  
2. The antenna is replaceable. Contact your OMRON representative for details.

Note: Unless otherwise specified, a tolerance of ±0.4 mm applies to all dimensions.

## Safety Precautions

Refer to *Safety Precautions for All Limit Switches*.

### CAUTION

Make sure that the antenna does not come into contact with the human body, otherwise an electric shock may be received.



### Precautions for Correct Use

#### Antenna Grounded through Sensing Object

##### <Size of Sensing Object>

###### • Grounded Object

If the sensing object is the following grounded conductor, its size will not affect the operation of the NL. Check for the presence of insulators sticking to the sensing object or the corrosion of the sensing object, however, so that the ground resistance will not exceed 3 kΩ.

###### Contact with Grounded Conductor

The sensing object is equivalently grounded through ground resistor R.

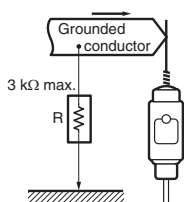

R: 3 kΩ max.

The sensing object must not come into contact with the human body.

###### • Non-grounded Object

If the sensing object is the following non-grounded conductor, the NL will operate if the capacitance between the sensing object and the ground is 100 pF or more. The larger the surface area of the sensing object is, the higher its capacitance will be. The shorter the distance between the sensing object and the ground is, the higher the capacitance will be. Furthermore, the capacitance greatly varies with the ground condition (e.g., dry sand, concrete, or wet soil).

###### Contact with Non-grounded Conductor

The sensing object is equivalently grounded through capacitor C.

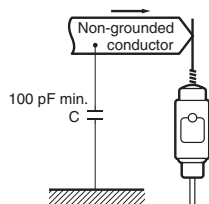

Generally, the conductor will be detectable if the ambient humidity is 60% to 70%RH and the surface area of the conductor is approximately 300 × 500 mm.

C: 100 pF min.

##### <Conditions of Sensing Object>

- The detection of conductors (e.g., iron, stainless steel, aluminum, and brass objects) poses no particular problem. A conductor coated with paint cannot be detected, however, because there is no electrical continuity between the antenna and the conductor.
- Non-conductive objects (e.g., plastic, ceramic, glass, and cloth objects) can be detected by grounding them indirectly.

#### Antenna

##### <Shape and Extension>

If a metal plate is used as an antenna by connecting it to the built-in or separated antenna of the NL, the surface area of the metal plate must be 200 cm<sup>2</sup> maximum. The antenna can be extended, provided that the total length of the antenna is 1 m maximum and that the bottom of the antenna is at least 10 cm away from the ground. Refer to the illustrations below.

Fig. 1

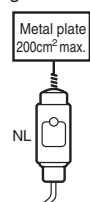

Fig. 2

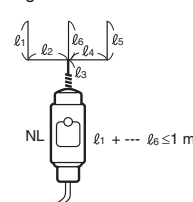
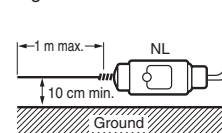
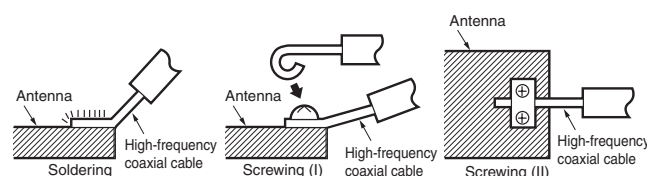

Fig. 3



#### Antenna Connection

To connect a suitable antenna to the high-frequency coaxial cable of the NL□-S, perform the following steps.



#### Braided Shield

- The shield is connected to the casing of the NL. Pay the utmost attention so that the conductor connected to the antenna will not come into contact with the shield. Secure the shield with insulation tape.

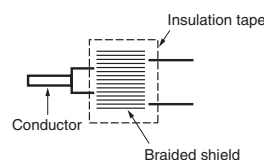

- If the antenna cable needs to be extended, use the separated antenna model. Do not use a standard cable in place of the high-frequency coaxial cable.

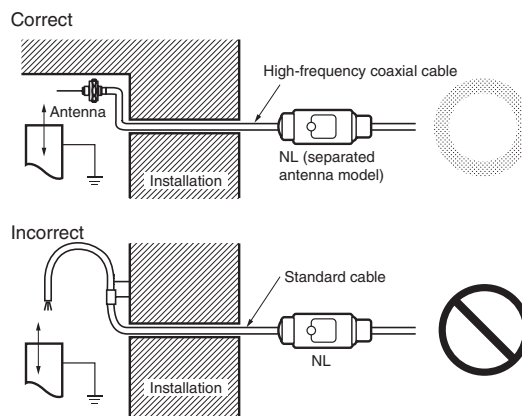

## <Antenna in Parallel>

If more than one NL is used in parallel or side-by-side, make sure that the distance between the antennas is at least 4 cm.

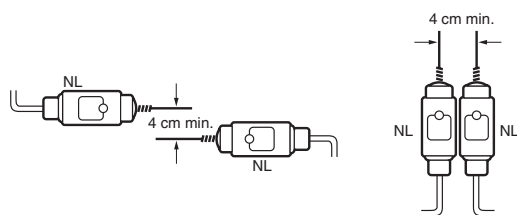

## <Maintenance>

**Make sure that the antenna is free of oil, dust, or rust, otherwise the antenna may not operate.**

Application in Locations Subject to Water or Oil.

Do not use the NL in places where water or oil (especially water-soluble oil) is frequently sprayed to the NL or antenna, otherwise the NL may malfunction.

## Grounding

- In order to maintain the operational reliability of the NL, be sure to ground the blue (black) wire of the power cable.
- The blue (black) lead wire of the connection cable will be connected to the casing internally if the model is the NL1 or NL2. The NL1 or NL2 does not operate with the service power supply of the PC (Programmable Controller) because the negative end of the service power supply is not grounded. The noise immunity performance of the PC will be degraded if the negative end of the service power supply is grounded.
- Provided that single-phase 200 V is supplied to the NL3, if one phase is grounded, the power supply will be short-circuited and a machinery breakdown will result. Use an isolating transformer and ground the secondary side of the transformer instead.
- To maintain operating reliability and durability, connect the blue (black) line in the connecting cable to ground.
- In the above case, be sure to ground the secondary side, otherwise the NL may not operate.

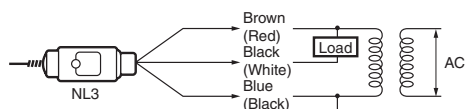

Note: The lead wire colors of the NL have been changed in compliance with the latest applicable JIS standards. Colors in parentheses are previous ones.

## Others

- Do not disassemble the NL, otherwise the internal wiring will be damaged and the NL will fail to operate.
- Make sure that the conduit opening is free of foreign materials or cuttings.
- The sealing of the NL uses nitrile butadiene rubber (NBR), which is highly oil resistant. If exposed to some types of oil or chemical indoors or outdoors, however, the NBR may deteriorate. Contact your OMRON representative for details.
- Make sure that the load is connected according to the connection diagram. The internal circuit of the NL will break due to mistakes in wiring or load short-circuiting.

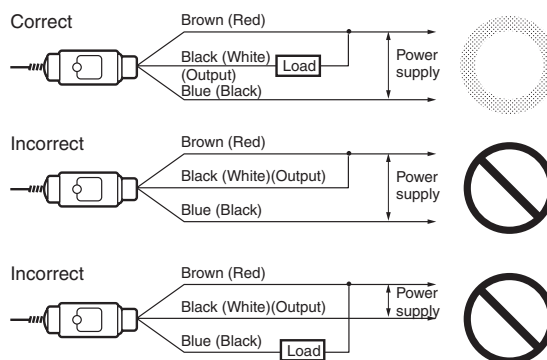

Note: The lead wire colors of the NL have been changed in compliance with the latest applicable JIS standards. Colors in parentheses are previous ones.

- Remove the warning label on the end of the connection cable before wiring.
- Load Switching  
The NL3 switches AC loads. The maximum switching load varies with the ambient temperature as shown in the following graph of load characteristic curves.

NL3 Load Characteristic Curves

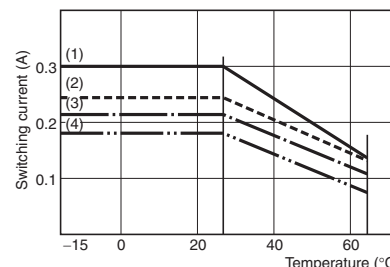

- Note: 1. Load (1) is an inductive load with a maximum repetitive operation rate of once per 5-minute period or resistive load.  
2. Load (2) is an inductive load with a maximum repetitive operation rate of 3 times per minute.  
3. Load (3) is an inductive load with a maximum repetitive operation rate of 30 times per minute.  
4. Load (4) is an inductive load with a maximum repetitive operation rate of 300 times per minute.  
5. Except for the resistive load, the characteristic curves cover repetitive operations in an ON-to-OFF ratio of 1:1. If the OFF period is extremely short in actual application, use 80% of the above values.

## Read and Understand This Catalog

Please read and understand this catalog before purchasing the products. Please consult your OMRON representative if you have any questions or comments.

## Warranty and Limitations of Liability

### WARRANTY

OMRON's exclusive warranty is that the products are free from defects in materials and workmanship for a period of one year (or other period if specified) from date of sale by OMRON.

OMRON MAKES NO WARRANTY OR REPRESENTATION, EXPRESS OR IMPLIED, REGARDING NON-INFRINGEMENT, MERCHANTABILITY, OR FITNESS FOR PARTICULAR PURPOSE OF THE PRODUCTS. ANY BUYER OR USER ACKNOWLEDGES THAT THE BUYER OR USER ALONE HAS DETERMINED THAT THE PRODUCTS WILL SUITABLY MEET THE REQUIREMENTS OF THEIR INTENDED USE. OMRON DISCLAIMS ALL OTHER WARRANTIES, EXPRESS OR IMPLIED.

### LIMITATIONS OF LIABILITY

OMRON SHALL NOT BE RESPONSIBLE FOR SPECIAL, INDIRECT, OR CONSEQUENTIAL DAMAGES, LOSS OF PROFITS OR COMMERCIAL LOSS IN ANY WAY CONNECTED WITH THE PRODUCTS, WHETHER SUCH CLAIM IS BASED ON CONTRACT, WARRANTY, NEGLIGENCE, OR STRICT LIABILITY.

In no event shall the responsibility of OMRON for any act exceed the individual price of the product on which liability is asserted.

IN NO EVENT SHALL OMRON BE RESPONSIBLE FOR WARRANTY, REPAIR, OR OTHER CLAIMS REGARDING THE PRODUCTS UNLESS OMRON'S ANALYSIS CONFIRMS THAT THE PRODUCTS WERE PROPERLY HANDLED, STORED, INSTALLED, AND MAINTAINED AND NOT SUBJECT TO CONTAMINATION, ABUSE, MISUSE, OR INAPPROPRIATE MODIFICATION OR REPAIR.

## Application Considerations

### SUITABILITY FOR USE

OMRON shall not be responsible for conformity with any standards, codes, or regulations that apply to the combination of products in the customer's application or use of the products.

At the customer's request, OMRON will provide applicable third party certification documents identifying ratings and limitations of use that apply to the products. This information by itself is not sufficient for a complete determination of the suitability of the products in combination with the end product, machine, system, or other application or use.

The following are some examples of applications for which particular attention must be given. This is not intended to be an exhaustive list of all possible uses of the products, nor is it intended to imply that the uses listed may be suitable for the products:

- Outdoor use, uses involving potential chemical contamination or electrical interference, or conditions or uses not described in this catalog.
- Nuclear energy control systems, combustion systems, railroad systems, aviation systems, medical equipment, amusement machines, vehicles, safety equipment, and installations subject to separate industry or government regulations.
- Systems, machines, and equipment that could present a risk to life or property.

Please know and observe all prohibitions of use applicable to the products.

NEVER USE THE PRODUCTS FOR AN APPLICATION INVOLVING SERIOUS RISK TO LIFE OR PROPERTY WITHOUT ENSURING THAT THE SYSTEM AS A WHOLE HAS BEEN DESIGNED TO ADDRESS THE RISKS, AND THAT THE OMRON PRODUCTS ARE PROPERLY RATED AND INSTALLED FOR THE INTENDED USE WITHIN THE OVERALL EQUIPMENT OR SYSTEM.

### PROGRAMMABLE PRODUCTS

OMRON shall not be responsible for the user's programming of a programmable product, or any consequence thereof.

## Disclaimers

### CHANGE IN SPECIFICATIONS

Product specifications and accessories may be changed at any time based on improvements and other reasons.

It is our practice to change model numbers when published ratings or features are changed, or when significant construction changes are made. However, some specifications of the products may be changed without any notice. When in doubt, special model numbers may be assigned to fix or establish key specifications for your application on your request. Please consult with your OMRON representative at any time to confirm actual specifications of purchased products.

### DIMENSIONS AND WEIGHTS

Dimensions and weights are nominal and are not to be used for manufacturing purposes, even when tolerances are shown.

### PERFORMANCE DATA

Performance data given in this catalog is provided as a guide for the user in determining suitability and does not constitute a warranty. It may represent the result of OMRON's test conditions, and the users must correlate it to actual application requirements. Actual performance is subject to the OMRON Warranty and Limitations of Liability.

### ERRORS AND OMISSIONS

The information in this document has been carefully checked and is believed to be accurate; however, no responsibility is assumed for clerical, typographical, or proofreading errors, or omissions.

2008.11

In the interest of product improvement, specifications are subject to change without notice.

**OMRON Corporation**  
Industrial Automation Company

<http://www.ia.omron.com/>

(c)Copyright OMRON Corporation 2008 All Right Reserved.



Компания «Океан Электроники» предлагает заключение долгосрочных отношений при поставках импортных электронных компонентов на взаимовыгодных условиях!

Наши преимущества:

- Поставка оригинальных импортных электронных компонентов напрямую с производств Америки, Европы и Азии, а так же с крупнейших складов мира;
- Широкая линейка поставок активных и пассивных импортных электронных компонентов (более 30 млн. наименований);
- Поставка сложных, дефицитных, либо снятых с производства позиций;
- Оперативные сроки поставки под заказ (от 5 рабочих дней);
- Экспресс доставка в любую точку России;
- Помощь Конструкторского Отдела и консультации квалифицированных инженеров;
- Техническая поддержка проекта, помощь в подборе аналогов, поставка прототипов;
- Поставка электронных компонентов под контролем ВП;
- Система менеджмента качества сертифицирована по Международному стандарту ISO 9001;
- При необходимости вся продукция военного и аэрокосмического назначения проходит испытания и сертификацию в лаборатории (по согласованию с заказчиком);
- Поставка специализированных компонентов военного и аэрокосмического уровня качества (Xilinx, Altera, Analog Devices, Intersil, Interpoint, Microsemi, Actel, Aeroflex, Peregrine, VPT, Syfer, Eurofarad, Texas Instruments, MS Kennedy, Miteq, Cobham, E2V, MA-COM, Hittite, Mini-Circuits, General Dynamics и др.);

Компания «Океан Электроники» является официальным дистрибьютором и эксклюзивным представителем в России одного из крупнейших производителей разъемов военного и аэрокосмического назначения «JONHON», а так же официальным дистрибьютором и эксклюзивным представителем в России производителя высокотехнологичных и надежных решений для передачи СВЧ сигналов «FORSTAR».



## JONHON

«JONHON» (основан в 1970 г.)

Разъемы специального, военного и аэрокосмического назначения:

(Применяются в военной, авиационной, аэрокосмической, морской, железнодорожной, горно- и нефтедобывающей отраслях промышленности)

«FORSTAR» (основан в 1998 г.)

ВЧ соединители, коаксиальные кабели, кабельные сборки и микроволновые компоненты:

(Применяются в телекоммуникациях гражданского и специального назначения, в средствах связи, РЛС, а так же военной, авиационной и аэрокосмической отраслях промышленности).



Телефон: 8 (812) 309-75-97 (многоканальный)

Факс: 8 (812) 320-03-32

Электронная почта: [ocean@oceanchips.ru](mailto:ocean@oceanchips.ru)

Web: <http://oceanchips.ru/>

Адрес: 198099, г. Санкт-Петербург, ул. Калинина, д. 2, корп. 4, лит. А