

# Amphenol<sup>®</sup> Heavy Duty Cylindrical Connectors

12-052-9



**MIL-C-22992**  
**Class L, QWLD**

---

**Amphenol**

---

Inside Cover is Blank

<b>Table of Contents</b>	<b>Page</b>
Amphenol® Heavy Duty Cylindrical Connectors, MIL-C-22992/Proprietary	
Design Characteristics, Environmental Testing	1
Heavy Duty Cylindrical Connectors	
MIL-C-22992, Class L	
General Information, Design Features	2, 3
How to Order	4
Contact Arrangements	5, 6
Alternate Insert Rotations	7
MS90555 Wall Mount Receptacle (power source)	8
MS90556 Straight Plug	9
MS90557 Cable Connecting Receptacle without coupling ring	10
MS90558 Wall Mount Plug with coupling ring (equipment end)	11
Accessories - Contacts	12
Accessories - Contact Bushing/Removal Tool	13
Accessories - Cable Strain Relief/Cable Sealing Gland	14
Accessories - Protective Covers	15
Installation Instructions	16-19
Heavy Duty Cylindrical Connectors	
MIL-C-22992, QWLD	
General Information, Design Features	21
How to Order	22
MIL-C-22992, QWLD Insert Arrangement Charts	23, 24
QWLD Special Insert Arrangement Chart	25
Alternate Insert Rotations	26
MIL-C-22992, QWLD Contact Arrangements	27-38
QWLD Special Contact Arrangements	39-47
QWLD Thermocouple Contact Arrangements	48-52
MS17343 or 10-1940XX Wall Mount Receptacle	53
MS17345 or 10-1941XX Cable Connecting Plug	54
MS17346 or 10-1942XX Box Mount Receptacle	55
MS17347 or 10-1943XX Jam Nut Receptacle (Wall Mount)	56
10-1944XX Thru-Bulkhead Receptacle	57
MS17344 or 10-1946XX Straight Plug	58
MS17348 or 10-1949XX Jam Nut Receptacle (Box Mount)	59
Accessories - M85049/X or 10-522958 Cable Sealing Adapters (Plug)	60-63
Accessories - M85049/X or 10-524959 Cable Sealing Adapters (Receptacle)	64-67
Accessories - Cable Clamp, Adapter	68, 69
Accessories - Protective Covers	70, 71
Accessories - Sealing Gaskets	72
Accessories - Encapsulation Adapter	73
Accessories - Encapsulation End Bell	74
MS Solder Contacts	75
Solderless Crimp Contacts	76
Application Tools (Crimp Type)	77
Heavy Duty Cylindrical Connectors	
Proprietary, QWL Series	
General Information, Design Features, (References Amphenol Catalog 12-053)	78
Sales Office Listing	

Amphenol Aerospace is a Certified ISO 9001 Manufacturer

This catalog covers Amphenol® Heavy Duty/ Power Connectors covered by MIL-C-22992.

The first section covers Class L Power Connectors, complete with insert arrangements, accessories and assembly instructions.

The second part covers our QWLD Heavy Duty Connectors. This second part is made up of 3 sections, including QWLD insert arrangements, connector shell styles and accessories.

If more information is needed concerning our Heavy Duty/Power Connectors, please contact:

Amphenol Corporation  
Amphenol Aerospace  
40-60 Delaware Avenue  
Sidney, New York 13838-1395  
Telephone: 607-563-5011  
Fax: 607-563-5157

This catalog and other product literature from Amphenol Aerospace and Amphenol Industrial Operations can be viewed, saved, and down-loaded from our website: [www.amphenol-aerospace.com](http://www.amphenol-aerospace.com).

Due to space limitations, metric equivalents of dimensional data in this catalog have not been included. All dimensions given may be converted to the metric system by the standard formula; Dimension (inches) x 25.40 = dimension (millimeters).

# Amphenol® Heavy Duty Cylindrical Connectors MIL-C-22992/Proprietary

- High Current Capacity
- Rugged Construction
- Safety
- Serviceability

Amphenol meets the demands for heavy duty connectors by providing three cylindrical connector series, each with unique design characteristics for reliable operation in specific industrial environments.

**Class “L”** – for the heaviest electrical loads (Pages 2 – 19)

- Current range from 40 to 200 amperes
- Direct current or single/three phase, 60/400 Hertz alternating current
- Automatic grounding for safety
- MIL-C-22992 qualification

**QWLD** – for most power and control circuits (Pages 21 – 77)

- Military (MIL-C-22992) qualified connectors and industrial equivalents available
- Increased shell size for greater durability than similar standard connectors

**QWL** – a more compact heavy duty design for industrial power and control applications (Page 78, references Amphenol Catalog 12-053)

These three series share the following common characteristics which are critical to reliable heavy duty connectors:

- Resistance to the operating environment. Refer to environmental data, below.
- Double stub coupling threads for faster connections; no cross threading, easy cleaning.
- Left hand accessory threads to minimize cable twisting, wire breakage, accidental connector disassembly.
- Gaskets or O-rings at appropriate surfaces for perfect weathertight connections.

Amphenol® heavy duty connectors have been exposed to the following environmental conditions, without compromise of mechanical integrity or degradation of electrical performance.



Condition	Configuration	Description	Reference
Thermal Shock	Unmated	Five complete one hour temperature cycles of -55°C to +125°C	MIL-STD-1344, method 1003, test condition A
Moisture Resistance (Cable mounted connectors)	Mated	Ten complete 24 hour cycles of +25°C to +65°C temperature at 90% to 98% humidity	MIL-STD-202, method 106
Durability	Mated	500 complete mating/unmating cycles	MIL-C-22992
Salt Spray (Corrosion)	Unmated	48 hour exposure to atomized 5% saline solution at +35°C	MIL-STD-1344, method 1001
Vibration	Mated	10 to 55 Hz, .06 inch total excursion in 1 minute cycles for 6 hours, 55 to 2000 Hz, 10G peak amplitude sweep	MIL-STD-1344, method 2005
High Impact	Mated	Nine hammer blows from 1, 3 and 5 feet, three each in three axes on mounting panel	MIL-STD-202, method 207
Heat Rise (Class L only)	Mated	Maximum rated DC current for four hours at +25°C in still air	MIL-C-22992
Fluid Immersion	Unmated	20 hours immersion in hydraulic fluid and lubricating oil	MIL-C-22992
Water Immersion	Mated and Unmated	4 hours immersion at 1 atmosphere pressure differential	MIL-C-22992



# Amphenol® Heavy Duty Cylindrical Connectors

## MIL-C-22992, Class L



The Amphenol® Class L\* heavy duty connectors are the largest size cylindricals, highly suitable for industrial or military applications, and designed to meet the demands of heavy power interconnections.

The design features of this connector series provide:

- **Greatest Capacity** - current ranges 40 to 200 amps, conductor sizes 6 to 4/0
- **Safety** - complete protection of personnel and equipment if connectors are inadvertently disconnected under load
- **Foolproof Mating** - design incorporates specific voltage, current, frequency, phase and grounding requirements
- **Standardization** - MIL-C-22992 Class L insert arrangements specify connector/cable combinations for maximum reliability
- **Serviceable Contacts** - contacts are normally crimped to the cable before connector assembly. No insertion tools required. Bushings are available to adapt smaller diameter wires to larger contacts

\* Amphenol design is covered by one or more of the following U. S. Patent Numbers: 3,023,396; 3,221,292.

# Amphenol<sup>®</sup> Heavy Duty Cylindrical Connectors MIL-C-22992, Class L

Class L connectors are available only in the specific configurations prescribed by MIL-C-22992 for either military or industrial applications. This rigid configuration control assures correct interconnection of electrical circuits for maximum safety and reliability. Controlled parameters include:

**Connector shell style and contact type** - wall mount and cable connecting receptacles are supplied with socket contacts only and always lead from the power source. Plugs (with coupling rings) have pin contacts only and always lead to the equipment end.

**Shell size** - the direct relationship of shell size to current carrying capability reduces the possibility of inadequate wiring for heavy electrical loads.†

Shell Size	Current Rating (Amperes)	Contact Size
28	40	6
32	60	4
44	100	1/0
52	200	4/0

**Keyway position** - four positions of the main keyway are used to discriminate between the following power sources:

- two wire D.C
- two wire single phase A.C.
- three wire single phase A.C.
- four wire three phase A.C.

**Insert rotation** - when carrying alternating current (A.C), different angular rotations of the insert within the connector shell are used to distinguish between 60 Hertz and 400 Hertz circuits.

## Other outstanding design features:

**Arc quenching design** - recessed socket contacts within the insert create an arc suppressing chamber which protects the user when connectors are separated under load.

**Programmed coupling sequence** - grounding and neutral contacts engage before power contacts.

**Waterproof design** - a unique combination of grommets and seals provides waterproofing in any condition - mated or unmated, capped or uncapped.

**Rugged construction** - machined from high strength aluminum. Straight-line attachment of accessories eliminates possibility of cable twisting or misalignment.

**Accessories** - supplied with all Class L connectors as indicated on the individual connector descriptions. Replacement accessories may be ordered separately. See pages 12 through 15.

† MIL-C-22992 includes shell size 48, rated at 150 amperes. Consult your local Amphenol sales representative or Amphenol, Sidney, NY for availability.

# MIL-C-22992, Class L

## how to order

Connectors are supplied with removable contacts unassembled and applicable accessories as listed in the individual connector style descriptions, pages 8 through 11. Additional/replacement contacts or accessories may be ordered by their MS designations.

Connectors are ordered by MS designation. To illustrate the ordering procedure, part number MS90555 C32412SY is shown as follows:

PART NUMBER

MS90555    C    32    4    12    S    Y

1            2    3    4    5    6    7

### 1. MS Number -

- MS90555 designates wall mount receptacle (*power source*)
- MS90556 designates straight plug
- MS90557 designates cable connecting receptacle without coupling ring
- MS90558 designates wall mount plug with coupling ring (*equipment end*)

### 2. Shell Finish - C (conductive) for AC or N (nonconductive) for DC circuits.

Grounding Assemblies: Finish C

Shell Size	Current Rating Amps	Shell Master Key/Keyway Position						
		60Hz & 400Hz						
		1 Phase			3 Phase			
		2 Wire		3 Wire	4 Wire			
	120 VAC	240 VAC	120/240 VAC	450/480 VAC	120/208 VAC	240/416 VAC	277/480 VAC	
28	40	4 (120°)	5 (135°)	4 (120°)	---	4 (120°)	5 (135°)	6 (150°)
32	60	4 (120°)	5 (135°)	4 (120°)	---	4 (120°)	5 (135°)	6 (150°)
44	100	4 (120°)	---	4 (120°)	1 (60°)	4 (120°)	5 (135°)	6 (150°)
52	200	---	---	4 (120°)	---	4 (120°)	5 (135°)	6 (150°)

Non-grounding Assemblies: Finish N

Shell Size	Current Rating Amps	Shell Master/Key Keyway Position
		DC
		2 Wire
		28 VDC
28	40	N (105°)
32	60	N (105°)
44	100	N (105°)
52	200	N (105°)

### 3. Shell Size - related directly to current carrying capability.

- Size 28 - 40 amperes
- Size 32 - 60 amperes
- Size 44 - 100 amperes
- Size 52 - 200 amperes

### 4. Master Key/Keyway Position - N designates normal position. Positions 1, 4, 5 and 6 of the master key/keyway prevent cross-mating of incompatible voltages. Refer to the adjacent illustration.

### 5. Insert Arrangement - determined by connector size (current carrying capability) and cable configuration to be accommodated. Refer to pages 5 & 6.

### 6. Contact Type - P for pin, S for socket. MS90555 and MS90557 are supplied with socket contacts **only**. MS90556 and MS90558 are supplied with pin contacts **only**.

### 7. Alternate Insert Rotation - used to prevent cross-mating of incompatible frequencies. Absence of a letter in this space indicates normal (0°) position of the insert. Refer to page 7.

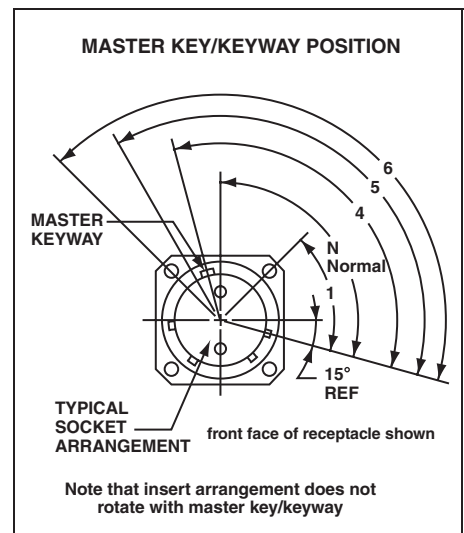

Amphenol Federal Vendor Identification  
FSCM77820



# MIL-C-22992, Class L contact arrangements

## Shell Size 28, 40 amp rating

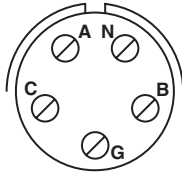

28-12, 28-13  
Three phase AC, 4 wire, grounding

### Cable:

28-12	IPCEA, type G, round, four #8 conductors
28-13	CO-04 HDF, (4/6-4/12R) 1090 per MIL-C-3432

### Contacts:

Position	Size	Pin M39029/48	Socket M39029/49
A, B, C	6	-317	-329
N, G	6N	-318	-329

## Shell Size 32, 60 amp rating



32-04, 32-05  
Single phase AC, 2 wire, grounding

### Cable:

32-04	IPCEA, type G, round, two #6 conductors
32-05	CO-02 HDF, (2/4-2/8R) 1100 per MIL-C-3432

### Contacts:

Position	Size	Pin M39029/48	Socket M39029/49
A	4	-320	-331
N	4N	-321	-331
G1, G2	6N	-318	-329

## Shell Size 32, 60 amp rating



32-12, 32-13  
Three phase AC, 4 wire, grounding

### Cable:

32-12	IPCEA, type G, round, four #6 conductors
32-13	CO-04 HDF, (4/4-4/12R) 1290 per MIL-C-3432

### Contacts:

Position	Size	Pin M39029/48	Socket M39029/49
A, B, C	4	-320	-331
N	4N	-321	-331
G	6N	-318	-329

## Shell Size 44, 100 amp rating



44-02, 44-03  
28 Volts DC, 2 wire

### Cable:

44-02	IPCEA, type W, round, two #2 conductors
44-03	CO-02 HDF, (2/1) 1385 per MIL-C-3432

### Contacts:

Position	Size	Pin M39029/48	Socket M39029/49
A	1/0-1	-323	-333
N	1/0N-1	-324	-333

# MIL-C-22992, Class L contact arrangements

## Shell Size 44, 100 amp rating



44-12, 44-13  
Three phase AC, 4 wire, grounding

### Cable:

44-12	IPCEA, type G, round, four #2 conductors
44-13	CO-04 HDF, (4/1-4/8R) 1620 per MIL-C-3432

### Contacts:

Position	Size	Pin M39029/48	Socket M39029/49
A, B, C	1/0-1	-323	-333
N	1/0N-1	-324	-333
G1, G2, G3, G4	6G	-319	-330

## Shell Size 44, 100 amp rating For Navy Ground Support Equipment use only.



44-50, 44-51, 44-52, 44-56  
Three phase AC, 3 wire, grounding

44-50	Available in MS90555 & MS90558 only 4 each # 1 conductors
-------	--

### Cable:

44-51	Available in MS90556 & MS90557 only IPCEA, type W, round, four # 1 conductors
44-52	Available in MS90556 only IPCEA, type W, round, four # 2 conductors
44-56	Available in MS90556 only IPCEA, type W, round, four # 6 conductors

### Contacts:

Position	Size	Pin M39029/48	Socket M39029/49
A, B, C	1/0-1	-323	-333
G	1/0N-1	-324	-333

## Shell Size 52, 200 amp rating



52-12, 52-13  
Three phase AC, 4 wire, grounding

### Cable:

52-12	IPCEA, type G, round, four #4/0 conductors
52-13	CO-04 HDE, (4/0000-4/4R) 2380 per MIL-C-3432

### Contacts:

Position	Size	Pin M39029/48	Socket M39029/49
A, B, C	4/0	-327	-335
N	4/0N	-328	-335
G1, G2, G3, G4	4G	-322	-332

# MIL-C-22992, Class L alternate insert rotations

To avoid cross-plugging problems in applications requiring the use of more than one connector of the same size and arrangement, alternate insert rotations are available as indicated in the accompanying chart.

As shown in the diagram below, the front face of the pin insert is rotated within the shell in a clockwise direction from the normal shell key. The socket insert would be rotated counterclockwise the same number of degrees in respect to the normal shell key.



Insert Arrangements	Keying Position (degrees from normal position)				
	DC or 60 Hz Normal	400 Hz			
		W	X	Y	Z
28-12	0	–	–	180	–
28-13	0	–	–	180	–
32-04	0	–	90	–	–
32-05	0	–	90	–	–
32-12	0	–	–	180	–
32-13	0	–	–	180	–
44-12	0	–	–	–	60
44-13	0	–	–	–	60
44-50	0	–	–	–	–
44-51	0	–	–	–	–
44-52	0	–	–	–	–
44-56	0	–	–	–	–
52-12	0	300	–	–	–
52-13	0	300	–	–	–

# MIL-C-22992, Class L MS90555

wall mount receptacle (power source)



All dimensions for reference only.

Shell Size	A Thread Class 2A .1428P-.2857L Double Stub	F* ±.031	G Dia. +.006 -0.010	H ±.005	J +.016 -0.000	N Dia. +.011 -0.020	R (BSC)	S +.021 -0.020	T Dia. ±.005
28	2.000	1.376	1.938	1.514	2.188	2.000	1.844	2.375	.177
32	2.250	1.376	2.188	1.514	2.188	2.250	2.062	2.625	.209
44	3.000	1.438	3.062	1.733	2.532	3.125	2.812	3.375	.281
52	3.500	1.438	3.562	1.733	2.532	3.625	3.156	3.875	.281

To complete MS Part number see how to order, pg. 4.

Protective cover MS90563 is supplied as part of this connector assembly. Refer to page 15 for dimensions.

\*F dimension applies only when rear nut is fully tightened

# MIL-C-22992, Class L MS90556 straight plug

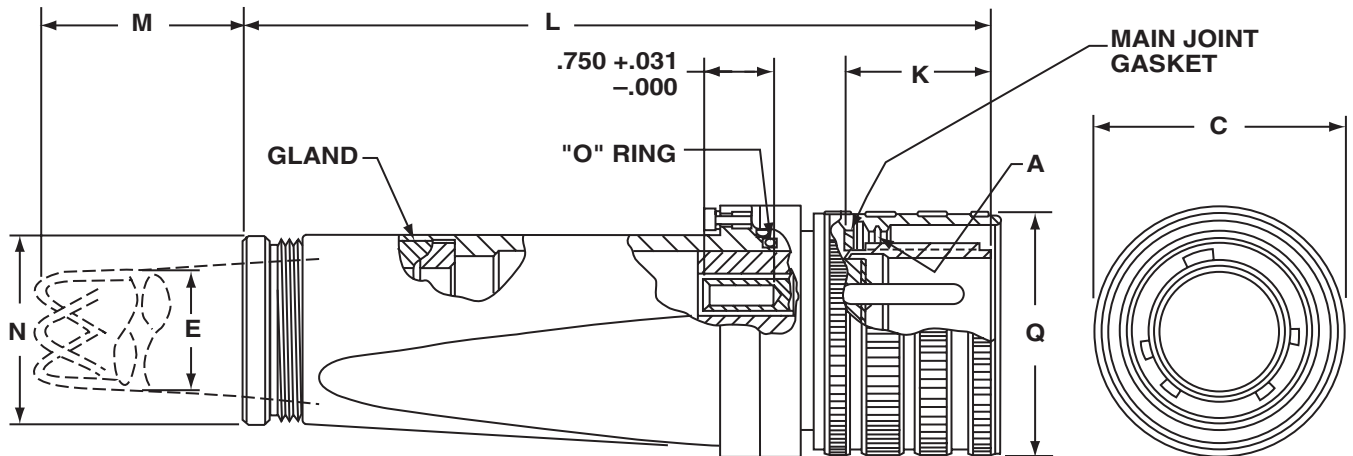

All dimensions for reference only.

Shell Size and Arrangement	A Thread Class 2B .1428P-.2857L Double Stub	C Dia. Max	E Cable Range	K $\pm .005$	L Max Free Length	M Approx. Free Length	N Dia $^{+.011}_{-.020}$	Q Dia. Max
28-12	2.000	2.439	1.047-.922	1.557	8.188	7.188	2.000	2.312
28-13			1.130-1.005			7.188		
32-04	2.250	2.689	.969-.844	1.557	8.188	7.188	2.000	2.562
32-05, -12			1.130-1.005			7.188		
32-13			1.342-1.217			8.688		
44-02	3.000	3.667	1.312-1.187	1.776	10.172	10.688	2.500	3.531
44-03			1.438-1.313			9.688		
44-12			1.516-1.391			10.688		
44-13			1.672-1.547			12.688		
44-51	3.000	3.667	1.734-1.609	1.776	10.172	11.688	2.500	3.531
44-52			1.525-1.435			11.188		
44-56			1.135-1.065			7.188		
52-12			3.500			4.167		
52-13	2.453-2.308	18.188						

To complete MS Part number see how to order, pg. 4.

Protective cover MS90564 is supplied as part of this connector assembly. Refer to page 15 for dimensions.

Contact brushings MS3348 are supplied as part of connector as required. Refer to page 13 for dimensions.

# MIL-C-22992, Class L MS90557

cable connecting receptacle *without coupling ring*

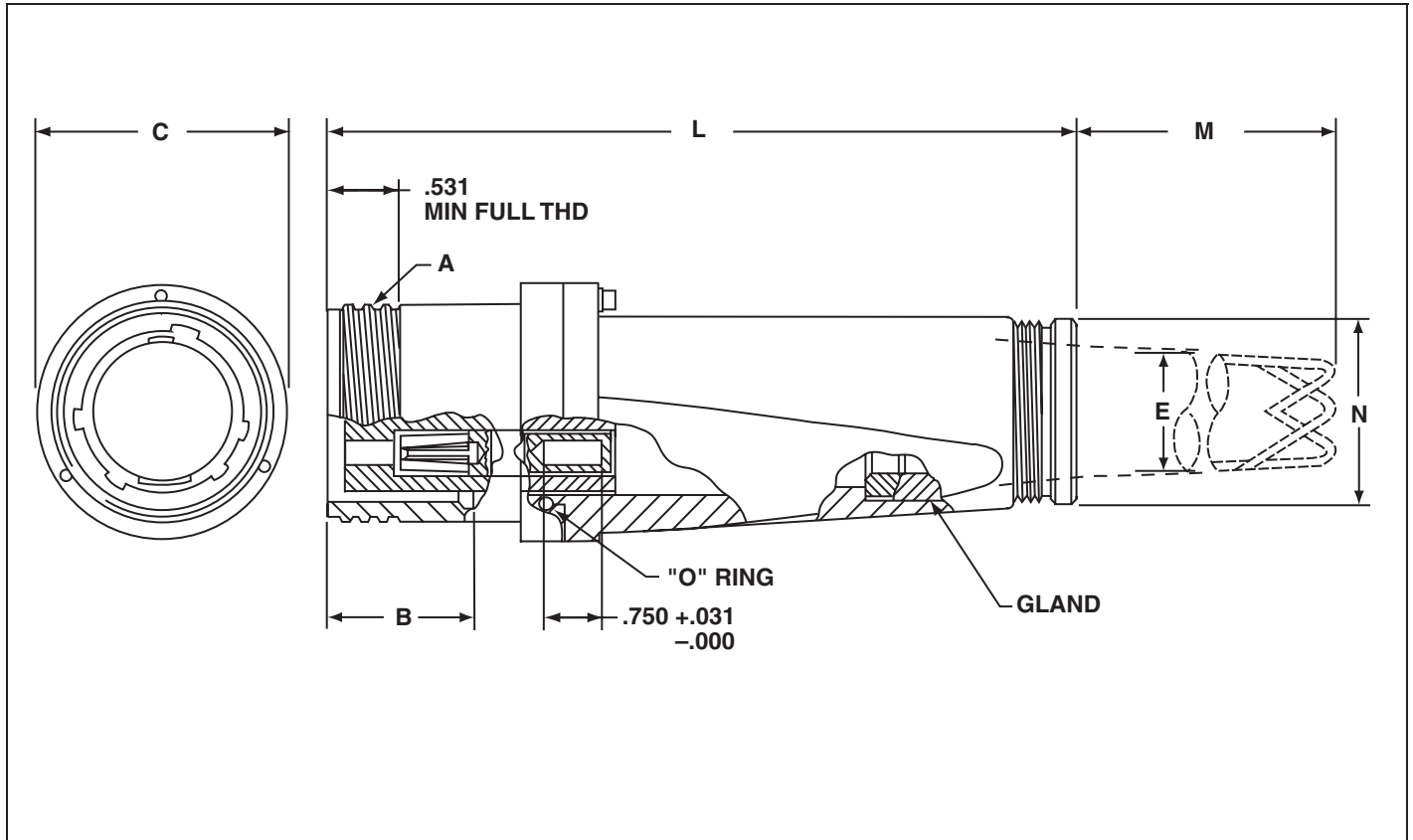

All dimensions for reference only.

Shell Size and Arrangement	A Thread Class 2A .1428P-.2857L Double Stub	B ±.005	C Dia. Max.	E Cable Range	L Max Free Length	M Approx. Free Length	N Dia +.011 -.020
28-12	2.000	1.514	2.439	1.047-.922	8.156	7.188	2.000
28-13				1.130-1.005		7.188	
32-04	2.250	1.514	2.689	.969-.844	8.156	7.188	2.000
32-05, -12				1.130-1.005		7.188	
32-13				1.342-1.217		8.688	
44-02	3.000	1.733	3.667	1.312-1.187	10.125	10.688	2.500
44-03				1.438-1.313		9.688	
44-12				1.516-1.391		10.688	
44-13				1.672-1.547		12.688	
44-51				1.734-1.609		11.688	
52-12	3.500	1.733	4.167	2.328-2.183	11.062	17.188	3.250
52-13				2.453-2.308		18.188	

To complete MS Part number see how to order, pg. 4.

Protective cover MS90563 is supplied as part of this connector assembly. Refer to page 15 for dimensions.

Contact bushings MS3348 are supplied as part of connector as required. Refer to page 13 for dimensions.



# MIL-C-22992, Class L MS90558

wall mount plug with coupling ring (*equipment end*)

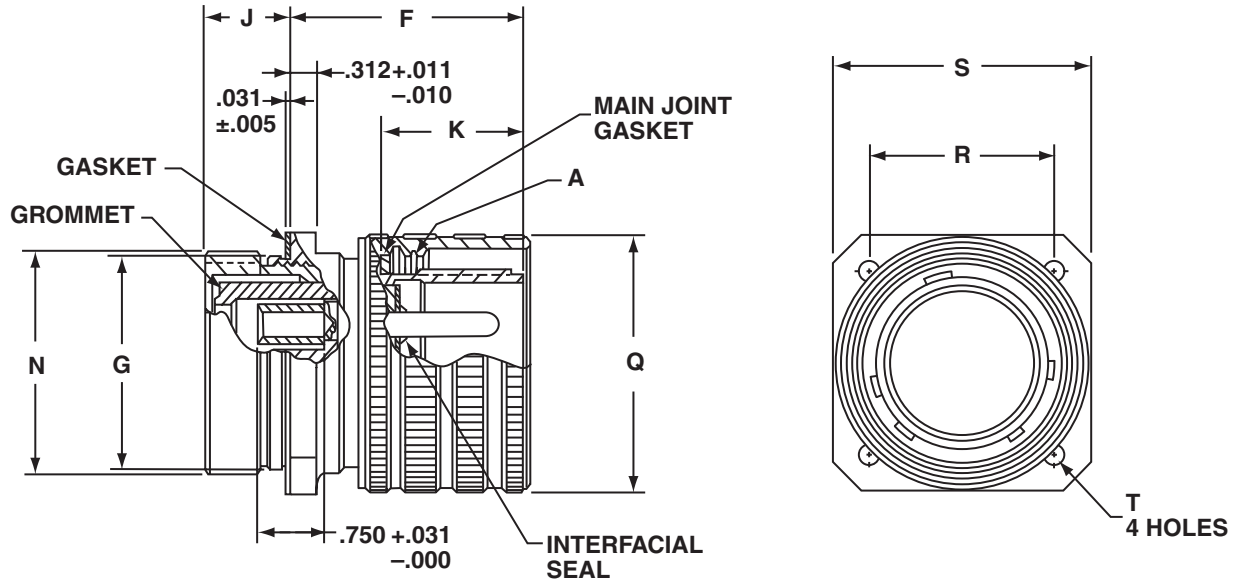

All dimensions for reference only.

Shell Size	A Thread Class 2B .1428P-.2857L Double Stub	J ±.031	G Dia +.006 -.010	F* +.016 -.000	K ±.005	N +.011 -.020	Q Dia. Max	R (BSC)	S +.021 -.020	T Dia. ±.005
28	2.000	.959	1.938	2.639	1.557	2.000	2.312	1.844	2.375	.177
32	2.250	.959	2.188	2.639	1.557	2.250	2.562	2.062	2.625	.209
44	3.000	1.021	3.062	2.998	1.776	3.125	3.531	2.812	3.375	.281
52	3.500	1.021	3.562	2.998	1.776	3.625	4.016	3.156	3.875	.281

To complete MS part number see how to order, pg. 4.

Protective cover MS90564 is supplied as part of this connector assembly. Refer to page 15 for dimensions.

\* F dimension applies only when rear nut is fully tightened.

# MIL-C-22992, Class L Accessories

## contacts

**M39029/48  
pin contact**

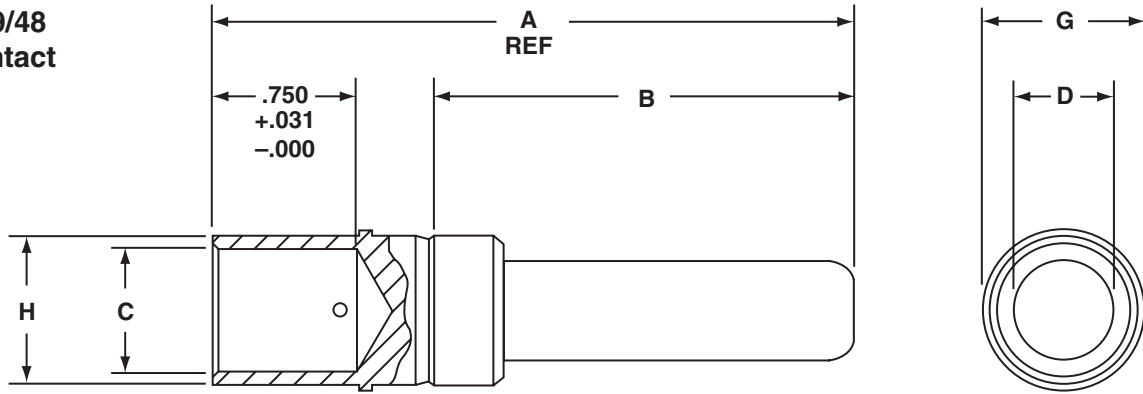

**M39029/49  
socket contact**

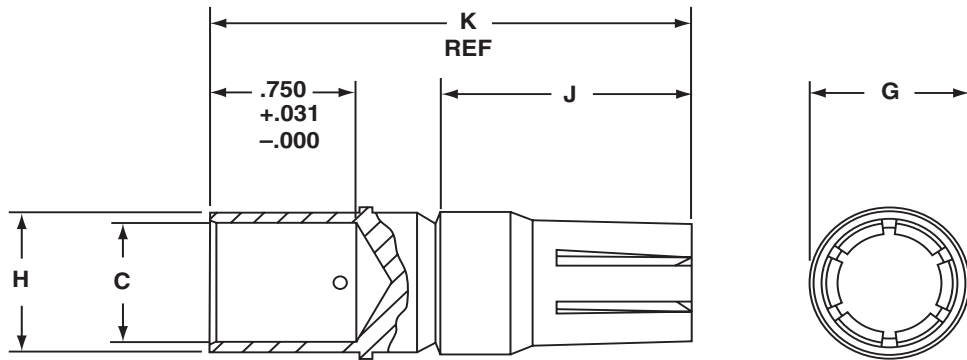

All dimensions for reference only.

Socket MS Part Number*	Pin MS Part Number	Contact Size	Wire Well Size	A Ref.	B $\pm .005$	C Dia $\pm .001$	D Dia $\pm .001$	G Dia	H Dia	J $\pm .005$	K Ref
M39029/49-335	M39029/48-327	4/0	4/0	3.207	2.097	$.641^{+.004}_{-.003}$	.500	$.781 \pm .003$	$.750^{+.004}_{-.003}$	1.283	2.393
---	M39029/48-328	4/0N	4/0	3.325	2.215	$.641^{+.004}_{-.003}$	.500	$.781 \pm .003$	$.750^{+.004}_{-.003}$	---	---
M39029/49-333	M39029/48-323	1/0	1	3.207	2.097	$.406^{+.004}_{-.003}$	.357	$.609 \pm .003$	$.506^{+.004}_{-.003}$	1.283	2.393
---	M39029/48-324	1/0N	1	3.325	2.215	$.406^{+.004}_{-.003}$	.357	$.609 \pm .003$	$.506^{+.004}_{-.003}$	---	---
M39029/49-331	M39029/48-320	4	4	2.786	1.738	$.281 \pm .002$	.225	$.417 \pm .002$	$.374 \pm .002$	1.158	2.206
---	M39029/48-321	4N	4	2.904	1.856	$.281 \pm .002$	.225	$.417 \pm .002$	$.374 \pm .002$	---	---
M39029/49-329	M39029/48-317	6	6	2.786	1.738	$.234 \pm .002$	.178	$.342 \pm .002$	$.312 \pm .002$	1/158	2.206
---	M39029/48-318	6N	6	2.904	1.856	$.234 \pm .002$	.178	$.342 \pm .002$	$.312 \pm .002$	---	---
M39029/49-332	M39029/48-322	4G	4	2.856	1.746	$.281 \pm .002$	.225	$.417 \pm .002$	$.374 \pm .002$	1.752	2.862
M39029/49-330	M39029/48-319	6G	6	2.856	1.746	$.234 \pm .002$	.178	$.342 \pm .002$	$.312 \pm .002$	1.752	2.862

\*Order by MS part number listed for either socket or pin.

# MIL-C-22992, Class L Accessories

## contact bushing/removal tool

### MS3348 contact bushing

All dimensions for reference only.

MS Part Number*	Contact Wire Barrel Size (Ref)	Wire Size (Ref)	A Dia +.010 -.003	B Dia +.002 -.003
MS3348-1 - 2L	1	2	.359	.396
MS3348-4 - 5L	4	5	.250	.272
MS3348-4 - 6L	4	6	.225	.272
MS3348-6 - 8L	6	8	.185	.225
MS3348-6 - 9L	6	9	.155	.225
MS3348-1 - 6L	1	6	.225	.396
MS3348-4 - 8L	4	8	.185	.272
MS3348-6 - 10L	6	10	.136	.225
MS3348-4/0-2/0L	4/0	2/0	.500	.629

\* Order by MS part number listed.

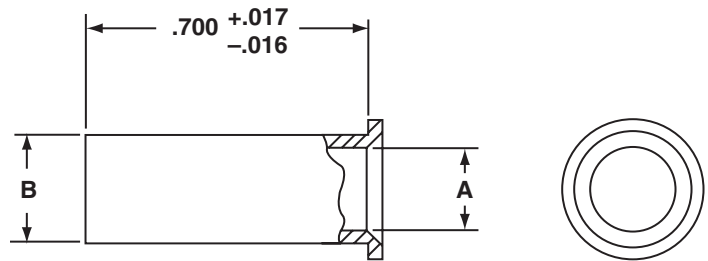

### MS90562 contact removal tool

All dimensions for reference only.

MS Part Number*	Contact Size	A Dia +.000 -.002
MS90562-1	4/0	.790
MS90562-2	2/0	.696
MS90562-3	1/0	.558
MS90562-4	2	.462
MS90562-5	4	.376
MS90562-6	6	.354

\* Order by MS part number listed.

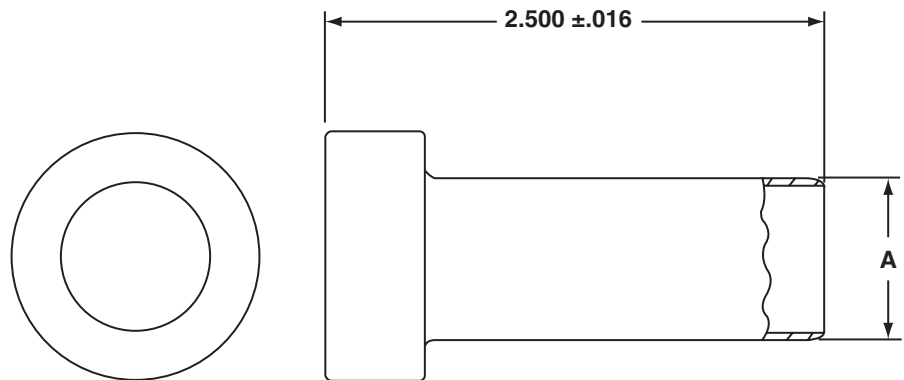

# MIL-C-22992, Class L Accessories

## cable strain relief/cable sealing gland

### MS90561 cable strain relief

All dimensions for reference only.

MS Part Number*	Arrangement Number	A Dia +.000 -.010	H Dia Cable Range		L Approx.
			Max	Min	
MS90561-2	28-13, 32-12	1.797	1.145	1.003	8.000
MS90561-4	28-02, -04	1.797	.844	.688	7.500
MS90561-12	28-12	1.797	1.047	.891	8.000
MS90561-13	32-13	1.797	1.342	1.185	9.500
MS90561-15	44-12	2.235	1.516	1.360	11.500
MS90561-16	44-13	2.235	1.688	1.531	13.500
MS90561-17	52-12	2.922	2.328	2.039	18.000
MS90561-18	52-13	2.922	2.500	2.211	19.000
MS90561-19	44-51	2.235	1.750	1.550	12.500
MS90561-20	44-52	2.235	1.578	1.375	12.000
MS90561-21	44-56	2.235	1.160	1.010	8.000

\* Order by MS part number listed.

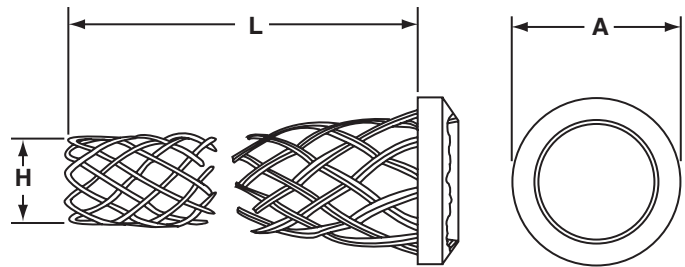

### MS23747 cable sealing gland

All dimensions for reference only.

MS Part Number*	Arrangement Number	A Dia +.000 -.020	B Dia +.020 -.000	C ±.010	Min Cable Dia Ref.
MS23747-2	28-13, 32-05, -12	1.805	1.130	1.034	1.005
MS23747-12	28-12	1.805	1.047	1.034	.922
MS23747-13	32-13	1.805	1.342	1.034	1.217
MS23747-14	44-03	2.242	1.438	1.160	1.313
MS23747-15	44-12	2.242	1.516	1.160	1.391
MS23747-16	44-13	2.242	1.672	1.160	1.547
MS23747-18	52-12	2.927	2.328	1.284	2.183
MS23747-19	52-13	2.927	2.453	1.284	2.308
MS23747-20	44-51	2.242	1.734	1.160	1.609
MS23747-21	44-52	2.242	1.562	1.160	1.437
MS23747-22	44-56	2.242	1.150	1.160	1.025

\* Order by MS part number listed.

This gland must be used with MS90561 strain relief.



# MIL-C-22992, Class L Accessories

## protective covers

### MS90563 protective covers used with: MS90555 wall mount receptacle MS90557 cable connecting receptacle

All dimensions for reference only.

MS Part Number*	Use with Shell Size	A Thread Class 2B .1428P-.2857L Double Stub	B Dia Ref		C Approx.
			For MS90555	For MS90557	
MS90563-1( )	28	2.000	.177	.177	6.000
MS90563-3( )	32	2.250	.209	—	4.500
MS90563-4( )	32	2.250	—	.177	6.000
MS90563-7( )	44	3.000	.281	.281	7.500
MS90563-11( )	52	3.500	.281	.281	7.500

\* To complete MS part number, add letter C (Conductive) for AC or N (Non-conductive) for DC connector assemblies.

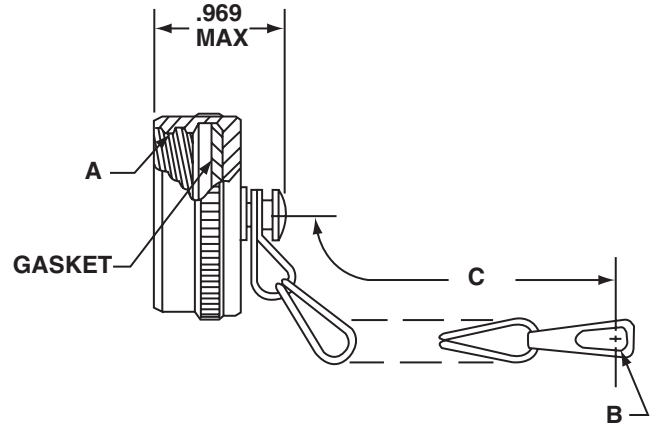

### MS90564 protective covers used with: MS90556 straight plug MS90558 wall mount plug

All dimensions for reference only.

MS Part Number*	Use with Shell Size	A Thread Class 2A (Plated) .1428P-.2857L Double Stub	B Dia Ref		C Approx.	J Max
			For MS90556	For MS90558		
MS90564-1( )	28	2.000	.177	.177	7.500	2.266
MS90564-3( )	32	2.250	—	.209	6.000	2.266
MS90564-4( )	32	2.250	.177	—	7.500	2.266
MS90564-7( )	44	3.000	.281	.281	8.500	2.484
MS90564-11( )	52	3.500	.281	.281	8.500	2.484

\* To complete MS part number, add letter C (Conductive) for AC or N (Non-conductive) for DC connector assemblies.

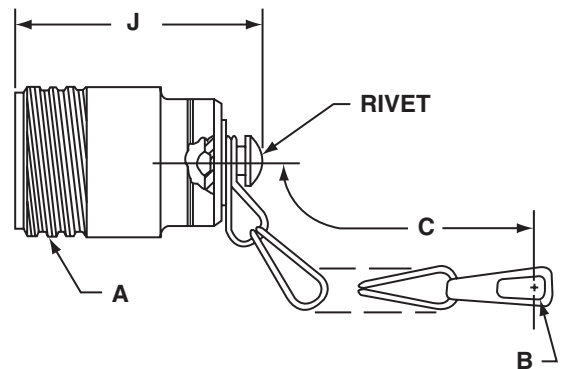

# MIL-C-22992, Class L installation instructions

Complete installation instructions (L-1014) for Class L connectors are available on request. Reproduced below are condensed assembly instructions to familiarize the user with the installation procedure and tooling required.

## Cable Preparation (MS90556 and MS90557 connectors only)

The following table shows the standard wire color coding, generator terminal markings, and connector contact identification used with Class L connectors.

### Standardized Generator Wiring and Connections

Generator Terminal Marking	Current	Contact Designation	Conductor Circuit	Wire Color
+ (POS)	28Vdc	A	Positive	Black
- (NEG) ground	28Vdc	N	Negative	White
L <sub>1</sub>	AC	A	Phase A	Black
L <sub>2</sub>	AC	B	Phase B	Red
L <sub>3</sub>	AC	C	Phase C	Blue (Commercial may be orange)
L <sub>0</sub>	AC	N	Neutral	White
G (or Gnd)	AC	G	Safety grounding	Green (Commercial may be bare)

**Step 1)** Determine cable lay to facilitate alignment of contacts and insert holes without wire crossing.

**Step 2)** Strip cable jacket to dimension shown. Avoid cutting or nicking individual conductor insulation.

Connector Size	D Inches Approx.
28	3.000
32	3.000
44	4.250
52	5.000



#### Note

Some insert arrangements require that two or more ground wires be terminated into one contact. Dimension D must therefore be increased to permit routing these wires around the larger conductors.

**Step 3)** Install connector components in the order shown in the applicable assembly view illustrated on pages 17 and 18.

**Step 4)** Strip insulation of individual conductors to 3/4 inch from end of conductor.



# MIL-C-22992, Class L installation instructions

## MS90555 Connector

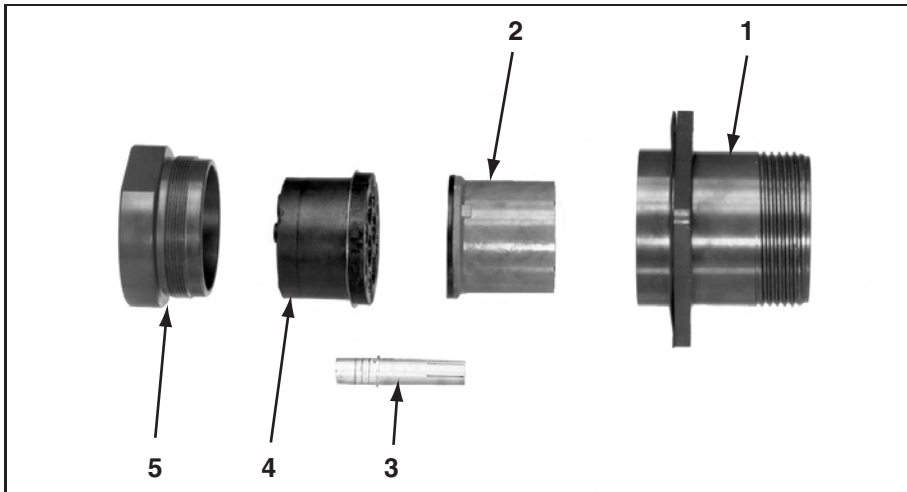

Wall Mount Receptacle Components:

1. Shell
2. Insert Assembly, Socket
3. Contact, Socket
4. Grommet Assembly, Socket
5. Nut, Retaining
6. Protective Cap Assembly (Not Shown)
7. Flange Gasket (Not Shown)

## MS90556 Connector



Straight Plug Components:

1. Shell and Coupling Nut Assembly
2. Insert Assembly, Pin
3. Contact, Pin
4. Spacer Assembly, Pin
5. Back Adapter
6. Gland Washer
7. Gland
8. Cable Grip
9. Gland Nut
10. Lockwasher (3 each)
11. Screw (3 each)
12. Protective Cap Assembly (Not Shown)

Note: On shell size 32 connectors, item #6 (Gland Washer) is contained within item #5 (Back Adapter).

# MIL-C-22992, Class L installation instructions

## MS90557 Connector

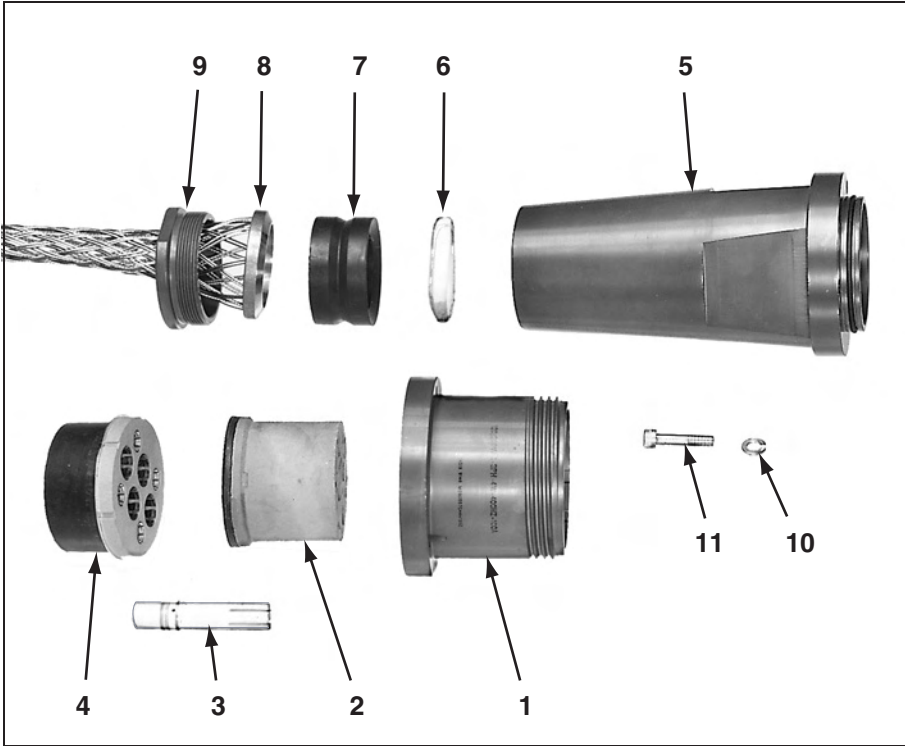

Cable Connecting Receptacle  
Components:

1. Shell
2. Insert Assembly, Socket
3. Contact, Socket
4. Spacer Assembly, Socket
5. Back Adapter
6. Gland Washer
7. Gland
8. Cable Grip
9. Gland Nut
10. Lockwasher (3 each)
11. Screw (3 each)
12. Protective Cap Assembly (Not shown)

Note: On shell size 32 connectors, item #6 (Gland Washer) is contained within item #5 (Back Adapter).

## MS90558 Connector

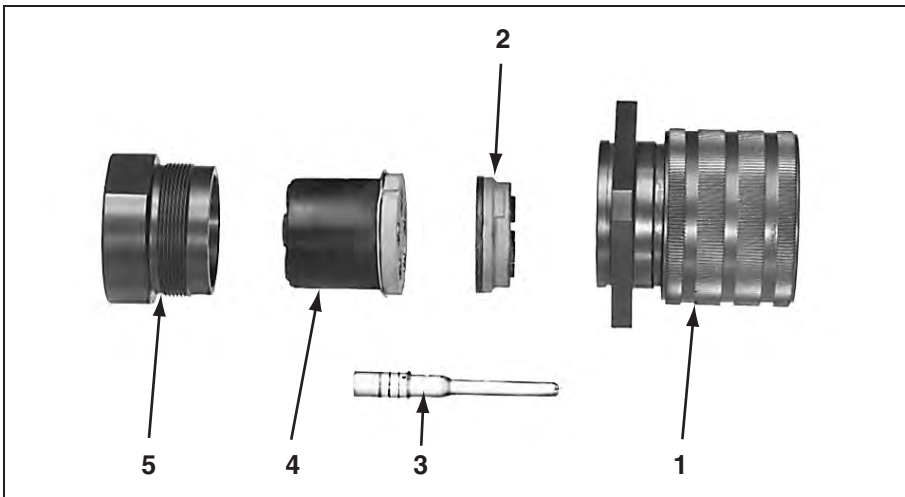

Wall Mount Plug Components:

1. Shell and Coupling Nut Assembly
2. Insert Assembly, Pin
3. Contact, Pin
4. Grommet Assembly, Pin
5. Nut, Retaining
6. Protective Cap Assembly (Not Shown)
7. Flange Gasket (Not Shown)

# MIL-C-22992, Class L installation instructions

## Contact Installation

**Step 1)** Insert stripped conductors in contact wirewells. If contact bushing is used, insert conductor in bushing and bushing in contact wirewell. If two or more ground wires are inserted into a single contact, make sure all wires are fully seated in wirewell.

**Step 2)** Select correct crimping tool, locator and die combination from the table for contacts to be installed. With conductor or contact bushing in place, insert contact into tool. Close crimping die fully to form a uniform crimp.

Contact Part Number	Size	Type	Crimping Tool*	Locator*	Die*	Removal Tool
M39029/48-327	4/0	P	Pico Model			
M39029/49-335	4/0	S	400B or	4297-1	414DA-4/0N-1	MS90562-1
M39029/48-328	4/0N	P	400B-1			
M39029/48-323	1/0	P	Pico Model			
M39029/49-333	1/0	S	400B or	4297-3	414DA-1/0N	MS90562-3
M39029/48-324	1/0N	P	400B-1			
M39029/48-320	4	P	Pico Model			
M39029/49-331	4	S	400B or	4297-5	414DA-4N	MS90562-5
M39029/48-321	4N	P	400B-1			
M39029/48-322	4G	P				
M39029/49-332	4G	S				
M39029/48-317	6	P	Pico Model			
M39029/49-329	6	S	400B or	4297-6	414DA-6N	MS90562-6
M39029/48-318	6N	P	400B-1			
M39029/48-319	6G	P				
M39029/49-330	6G	S				

\* Available from Pico Crimping Tools Co.,  
9832 Jersey Ave.  
Santa Fe Springs, CA 90670  
Phone: 805-388-5510

If crimping tools are available, contacts may be affixed to conductors by soldering. Use rosin-alcohol solder flux, a good grade of 60/40 solder and a 500 watt soldering iron or probe type resistance soldering equipment. Pre-tin conductors before soldering. Solder must not be present on shoulder or retention area of contact.

## Connector Assembly

**Step 1)** If inserts are not already positioned in the connector shell, align large tab on insert with large slot in shell and push insert in until it bottoms in shell.

**Step 2)** Apply a thin coating of Dow Corning DC-4 lubricant to the periphery of contact holes in spacer or grommet assembly. Push contacts into rear of spacer or grommet assembly until locked into contact retainer bushing.

**Step 3)** Align contacts with proper holes in insert. Small key of insert must be aligned with appropriate keyway in spacer or grommet assembly. Slide contacts into insert holes until spacer or grommet assembly butts against insert. A thin film of Dow Corning DC-4 lubricant applied to the periphery of insert contact holes will provide maximum sealing efficiency.

**Step 4)** Assemble accessories to connector. The back adapter "O" ring should have a very thin film of Dow Corning DC-4 lubricant applied. Outer surfaces only of gland should be lubricated with a thin film of UniTemp Grease EP. Avoid getting grease on inside surfaces of gland and on cable jacket.

**Step 5)** Tighten retaining nut or gland nut on shell or adapter. A metal-to-metal seating condition is desirable, but may not be attainable with maximum cable diameters.

## Contact Removal

**Step 1)** Loosen all rear accessories and slide back along cable.

**Step 2)** Remove spacer or grommet assembly with contacts from connector insert.

**Step 3)** Using the appropriate size contact removal tool, push tool over front of contact until it bottoms in spacer or grommet assembly hole. This will open contact retaining bushing and allow contact to be removed from the spacer or grommet assembly from the rear. When using jacketed cable, all contacts should be released from contact retention bushings before removal from spacer or grommet assembly is accomplished.

**Heavy Duty  
Cylindrical  
MIL-C-22992  
QWLD**

# Amphenol® Heavy Duty Cylindrical Connectors

## MIL-C-22992, QWLD



wall mount receptacle

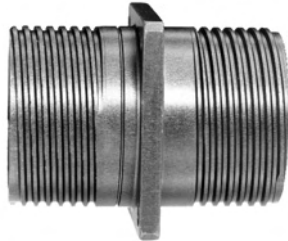

thru bulkhead receptacle



cable connecting plug



straight plug



box mount receptacle



jam nut receptacle  
(box mount)



jam nut receptacle  
(wall mount)

Amphenol® QWLD Series heavy duty cylindrical connectors provide reliable power and control functions in hostile environments where ordinary connectors cannot survive.

**Design features of this connector series provide:**

- **High Durability** - water and explosion proof, resistant to abrasion, corrosion, vibration and shock
- **Quick, Positive Mating** - double stub threads per MIL-STD-1373 for fast coupling, easily cleaned
- **Selection** - over 300 industrial and MS-approved insert patterns available, including coaxial and thermocouple

On the drilling platform in the North Sea, pump and motor generator controls run smoothly, although constantly exposed to salt spray.

At Prudhoe Bay where the nights are six months long, portable lighting systems permit operation regardless of temperature plummeting to 50° below zero.

The circus ferris wheel runs continuously despite the fact that it has rained for five days and all power connections are lying in six inches of mud.

These situations are typical of the extreme conditions under which thousands of Amphenol QWLD connectors are operating daily. Outstanding design features that make these cylindricals a necessity for difficult applications include:

- Alumilite 225\* hard anodic finish for abrasion and corrosion resistance or conductive cadmium plate
- Resilient inserts for moisture sealing, positive proof against shock and vibration
- Sealing gaskets at every joint for water-proof assembly
- Cable strain relief provided by clamp bar type accessories
- Left hand accessory threads to prevent damage from disconnect torque applied in the wrong direction
- Closed entry socket contact design in solder or replaceable crimp contacts

\* Registered trademark of Aluminum Company of America

# MIL-C-22992, QWLD

## how to order

### MS-APPROVED CONNECTORS

To illustrate the ordering procedure, part number MS17343R20N27PW is shown as follows:

	PART NUMBER						
<u>MS17343</u>	<u>R</u>	<u>20</u>	<u>N</u>	<u>27</u>	<u>P</u>	<u>W</u>	
1	2	3	4	5	6	7	

#### 1. MS Number -

- MS17343 designates wall mount receptacle
- MS17344 designates straight plug
- MS17345 designates cable connecting plug
- MS17346 designates box mount receptacle
- MS17347 designates jam nut receptacle with rear accessory threads (wall mount)
- MS17348 designates jam nut receptacle (box mount)

#### 2. Class -

- C designates pressurized - used where circuit integrity is protected by a pressure differential
- R designates environmental - see table, page 1

#### 3. Shell Size - available in shell sizes 12 through 44. Refer to pages 53 through 59 for dimensional data.

#### 4. Shell Finish - C for conductive or N for non-conductive

#### 5. Insert Arrangement - current MS insert arrangements are shown in black in the QWLD insert arrangements section of this catalog. Only these arrangements are available in MS-approved connectors.

#### 6. Contact Type - P for pin, S for socket

#### 7. Alternate Insert Rotation - used to prevent cross-mating of connectors. Absence of a letter in this space indicates normal (0°) position of the insert. Refer to page 26 for alternate insert rotation illustrations.

### QWLD INDUSTRIAL VERSIONS

These heavy duty connectors are identical to MS-approved types except for the added flexibility of connector shell and contact type and finish options, plus added insert arrangements. To illustrate the ordering procedure, part number 10-194622-14S is shown as follows:

	PART NUMBER				
10	-	194	6	22-14	S
<u>1</u>		<u>2</u>	<u>3</u>	<u>4</u>	<u>5</u>

#### 1. Base Number Prefix - used to define connector shell finish and contact type and finish

- 10 - Solder type contacts, silver plated
- 75- Crimp type contacts, silver plated
- 81- Crimp type contacts, plated .0001 gold over silver
- 82- Crimp type contacts for MIL-C-13777 cable, silver plated
- 83- Crimp type contacts for MIL-C-13777 cable, plated .0001 gold over silver
- 85- Crimp type contacts, plated .00005 gold over silver
- All above prefix numbers utilize connector shells with Alumilite\* non-conductive finish*
- 88- Solder type contacts, silver plated. Connector shell utilizes olive drab cadmium plate over nickel conductive finish.

#### 2. Base Number - QWLD Series Heavy Duty Cylindrical Connector

#### 3. Shell Style -

- 0 designates wall mount receptacle
- 1 designates cable connecting plug
- 2 designates box mount receptacle
- 3 designates jam nut receptacle with rear accessory threads (wall mount)
- 4 designates thru bulkhead receptacle
- 6 designates straight plug
- 9 designates jam nut receptacle (box mount)

#### 4. Shell Size/Insert Arrangement - Amphenol® QWLD connectors are available in equivalent MS shell sizes with all current MS insert arrangements as well as a large selection of special arrangements for power and signal circuits. Select the required insert arrangement number from those shown in black (MS arrangements) or red (industrial arrangements).

#### 5. Contact Type/Alternate Insert Rotation - P for pin, S for socket. When an alternate position of the connector insert is required to prevent cross-mating of connectors, a different letter (other than P or S) is used. Select from the table below the Amphenol® letter which indicates both type of contact and insert rotation desired. Refer to page 26 for alternate insert rotation illustrations.

Pin Contacts		Socket Contacts	
MS Letters	Amphenol® Letters	MS Letters	Amphenol® Letters
P	P (normal)	S	S (normal)
PW	G	SW	H
PX	I	SX	J
PY	K	SY	L
PZ	M	SZ	N

Alumilite is a registered trademark of Aluminum Co. of America



# MIL-C-22992, QWLD

## insert arrangements

Insert Arrangement		Service Rating	Total Contacts	Contact Size				
MS Approved	Industrial			0	4	8	12	16
12-5		D	1				1	
	12-48	A	3					3
	12-49	A	2					2
14-3		A	1			1		
	14-53	Inst.	6					6
16-2		E	1				1	
16-7		A	3			1		2
16-9		A	4					2
16-10		A	3				3	
16-11		A	2				2	
16-12		A	1		1			
16-13		A	2				2	
	16-61	A	7				7	
18-1		B, C, F, G = A; Bal. = Inst.	10					10
	18-3	D	2				2	
18-4		D	4					4
18-5		D	3				2	1
18-6		D	1		1			
18-7		B	1			1		
18-8		A	8				1	7
18-9		Inst.	7				2	5
	18-10	A	4				4	
18-11		A	5				5	
	18-12	A	6					6
18-13		A	4			1	3	
18-14		A	2		1			1
18-15		A	4				4	
18-16		C	1				1	
	18-17	Inst.	7				2	5
	18-19	A	10					10
	18-20	A	5					5
	18-22	D	3					3
	18-24	B, C, F, G = A; Bal. = Inst.	10					10
	18-29	A	5					5
	18-30	A	5					5
	18-31	A	5					5
20-2		D	1	1				
	20-3	D	3				3	
20-4		D	4				4	
	20-6	D	3					3
20-7		A, B, H, G = D; C, D, E, F = A	8					8
20-8		Inst.	6			2		4

Insert Arrangement		Service Rating	Total Contacts	Contact Size				
MS Approved	Industrial			0	4	8	12	16
20-9		H = D; Bal. = A	8				1	7
	20-11	Inst.	13					13
	20-12	A	2		1			1
20-14		A	5			2	3	
20-15		A	7				7	
20-16		A	9				2	7
20-17		A	6				5	1
20-18		A	9				3	6
	20-19	A	3			3		
	20-20	A	4		1		3	
20-21		A	9				1	8
20-22		A	6			3		3
	20-23	A	2			2		
20-24		A	4			2		2
	20-25	Inst.	13					13
20-27		A	14					14
20-29		A	17					17
	20-30	Inst.	13					13
20-33		A	11					11
	22-1	D	2			2		
22-2		D	3			3		
	22-4	A	4			2	2	
22-5		D	6				2	4
	22-6	D	3			2		1
22-7		E	1	1				
	22-8	E	2				2	
22-9		E	3				3	
22-10		E	4					4
22-11		B	2					2
22-12		D	5			2		3
	22-13	E = D; A, B, C, D = A	5				4	1
22-14		A	19					19
22-15		D = E; A, B, C, E, F = A	6				5	1
	22-16	A	9				3	6
22-17		A = D; Bal. = A	9				1	8
22-18		A, B, F, G, H = D; C, D, E = A	8					8
22-19		A	14					14
	22-20	A	9					9
22-21		A	3	1				2
22-22		A	4			4		
22-23		H = D; Bal. = A	8				8	
	22-24	C, D, E = D; A, B, F = A	6				2	4

# MIL-C-22992, QWLD

## insert arrangements

Insert Arrangement		Service Rating	Total Contacts	Contact Size				
MS Approved	Industrial			0	4	8	12	16
22-27		J = D; Bal. = A	9			1		8
	22-28	A	7				7	
	22-33	A, B, C, D = D; E, F, G = A	7					7
	22-34	D	5				3	2
22-36		H = D; Bal. = A	8				8	
24-2		D	7				7	
	24-3	D	7				2	5
	24-5	A	16					16
24-6		A, G, H = D; Bal. = A	8				8	
24-7		A	16				2	14
	24-9	A	2		2			
24-10		A	7			7		
24-11		A	9			3	6	
24-12		A	5		2		3	
24-16		A, B, F, G = D; C, D, E = A	7			1	3	3
	24-17	D	5				2	3
24-20		D	11				2	9
24-21		D	10			1		9
24-22		D	4			4		
24-27		E	7					7
24-28		Inst.	24					24
28-1		A, J, E = D; Bal. = A	9			3	6	
28-2		D	14				2	12
28-3		E	3			3		
28-4		G, P, S = E; Bal. = D	9				2	7
28-5		D	5		2		1	2
	28-6	D	3		3			
	28-7	D	2		2			
28-8		L, M = E; B = D; Bal. = A	12				2	10
28-9		D	12				6	6
28-10		G = D; Bal. = A	7		2	2	3	
28-11		A	22				4	18
28-12		A	26					26
	28-13	A	26					26
28-15		A	35					35
	28-16	A	20					20
28-17		R = B; M, N, P = D; A to L = A	15					15
28-18		M = C; G, H, J, K, L = D; A, B = H; Bal. = Inst.	12					12
28-19		H, M = B; A, B = D; Bal. = A	10				4	6
28-20		A	14				10	4

Insert Arrangement		Service Rating	Total Contacts	Contact Size				
MS Approved	Industrial			0	4	8	12	16
28-21		A	37					37
28-22		D	6			3		3
32-1		A = E; Bal. = D	5	2			3	
32-2		E	5			3		2
32-3		D	9	1	2		2	4
	32-4	F, J, K, N = A; Bal. = D	14				2	12
	32-5	D	2	2				
32-6		A	23		2	3	2	16
32-7		A, B, h, j = Inst.; Bal. = A	35				7	28
	32-8	A	30				6	24
32-9		D	14		2			12
	32-10	A, F = E; G = B; B, E = D; C, D = A	7		2	2		3
	32-12	C, D, E, F, G = A; Bal. = D	15				5	10
32-13		D	23				5	18
32-15		D	8	2			6	
	32-16	A	23		2	3	2	16
32-17		D	4		4			
32-73		A	46					46
	36-1	D	22				4	18
36-3		D	6	3			3	
	36-4	A = D; B, C = A	3	3				
36-5		A	4	4				
36-6		A	6	2	4			
36-7		A	47				7	40
36-8		A	47				1	46
36-9		A	31		1	2	14	14
36-10		A	48					48
	36-11	A	48					48
	36-12	A	48					48
	36-13	N, P, Q = E; Bal. = A	17				2	15
	36-14	D	16			5	5	6
36-15		M = D; Bal. = A	35					35
	36-16	A	47				7	40
	36-17	A	47				7	40
	36-18	A	31		1	2	14	14
	36-20	A	34			2	2	30
36-52		A	52					52
40-1		D	30				6	24
40-9		A	47			1	22	24
40-56		A	85					85
44-52		A	104					104

# QWLD

## special insert arrangements

Insert Arrangement	Service Rating	Total Con-acts	Contact Size											
			0	4	8	12	16	Coax**						
								0	4	8	12			
16-59	A	4				4								
20-51	A	3			3									
20-57	A	7				7*								
20-58	A	10				5	5							
20-59	A	3			3*									
20-66	A	6				5*	1							
20-79	A/D	8				1	7							
22-63	A	12				4	8							
22-65	A/D	8				8*								
22-70	A	13				8	5							
22-80	A	3			3*									
24-51	A	5			5									
24-52	Hi Volt.	1				1								
24-53	A	5			5									
24-58	A	13			3	3	7							
24-59	A	14				7	7							
24-60	A	7			7*									
24-65	A	15				11	4							
24-66	D	7				7								
24-67	Inst.	19				19								
24-71	A	7			7*									
24-75	A	7			7*									
24-79	A	5			5									
24-80	Inst.	23					23							
24-84	A	19				1							18	
28-51	A	12				12								
28-59	A	17				7	10							
28-66	A	16			2	14								
28-72	Coax	3								3				
28-74	A	16			7*		9							
28-75	A	16			7*		9							
28-79	A	16			7		9							
28-82	D	6			2	4								
28-84	A	9			9									
32-52	D	8	2			6								
32-53	Inst./E	42				5	37							
32-56	A	30				6*	24							
32-57	Coax	8				6		2						
32-58	Coax	4								4				
32-60	A	23					15				8			
32-62	Coax	23		2	1	2	16					2		
32-64	Inst.	54					54							
32-68	A	16					12	4						
32-75	Coax	9				2					7			
32-76	A	19				19								
32-79	D	5		4	1									

Insert Arrangement	Service Rating	Total Con-acts	Contact Size											
			0	4	8	12	16	Coax**						
								0	4	8	12			
36-51	D	4	2	2										
36-54	A	39			8		31							
36-55	A	39			8*		31							
36-59	A	53				3*	50							
36-60	A	47				7*	40							
36-64	Coax	4								4				
36-65	Coax	4								4				
36-71	A	53				3	50							
36-73	Coax	7									7			
36-74	A	44					43					1		
36-75	A	48					48*							
36-76	A	47					47							
36-77	D	7		7										
36-78	A	14				12		2						
36-79	A	20					20							
36-80	A	20					20*							
36-83	Coax	7									7			
36-85	A/D	35					35*							
40-53	A	60					60							
40-57	E	4	4											
40-61	A	59				1	3	55						
40-62	A	60						60						
40-63	A	61						61*						
40-64	Coax	36				3	20					13		
40-66	Coax	4								4				
40-67	A	11					1				10			
40-68	A	21				21								
40-70	A	61						61						
40-72	A	11						1			10			
40-73	A	61						61						
40-74	A	6					1			4	1			
40-75	E	5	4				1							
40-80	A	11				10		1						
40-81	A	62						62*						
40-82	A	62						62						
40-85	A	60						60*						
40-86	E	4								4				
40-87	D	7				7								
44-53	A	36						18				18		
48-51†	A	56				10		42	4					
48-52†	A	61						56	5					
48-53†	D	37					37							
48-54†	A	56				10		42	4					
48-55†	A	78				6	2	2	68					
48-57†	A	56	4			10		42						
48-60†	A	56				10		42	4					

\* Crimp contacts accommodate wire the same size as the contact as well as wire of the next smaller, even size. Arrangements identified with an asterisk (\*) are exceptions. See insert arrangement drawings on pages 39-47 for application wire size.

\*\* Coaxial cable data can be found on insert arrangement drawings, pages 39-47. For further information on coaxial contacts and cable see catalog 12-130.

† Consult Sidney, NY for availability.

# MIL-C-22992, QWLD

## alternate insert rotations

To avoid cross-plugging problems in applications requiring the use of more than one connector of the same size and arrangement, alternate insert rotations are available as indicated in the accompanying chart.

As shown in the diagram below, the front face of the pin insert is rotated within the shell in a clockwise direction from the normal shell key. The socket insert would be rotated counterclockwise the same number of degrees in respect to the normal shell key.



The following insert arrangements have the same alternate insert rotations for W, X, Y and Z which are:

Degrees			
W	X	Y	Z
80	110	250	280

16-7	20-14	22-16	24-3	24-21	28-16	32-9
18-5	20-16	22-17	24-4	24-28	28-17	32-10
18-9	20-20	22-18	24-5	28-1	28-19	32-12
18-13	20-22	22-19	24-6	28-4	28-20	32-13
18-14	22-3	22-21	24-7	28-8	28-21	36-1
20-7	22-6	22-24	24-12	28-9	32-1	36-7
20-8	22-12	22-25	24-16	28-10	32-3	36-8
20-9	22-14	22-33	24-17	28-11	32-4	36-13
20-12	22-15	22-34	24-20	28-15	32-6	

Insert Arrangement	Degrees			
	W	X	Y	Z
16-9	35	110	250	325
16-10	90	180	270	-
16-11	35	110	250	325
16-13	35	110	250	325
16-61	80	-	-	280
18-1	70	145	215	290
18-3	35	110	250	325
18-4	35	110	250	325
18-8	70	-	-	290
18-10	-	120	240	-
18-11	-	170	265	-
18-12	80	-	-	280
18-15	-	120	240	-
18-19	-	120	240	-
18-20	90	180	270	-
18-22	70	145	215	290
18-29	90	180	270	-
20-3	70	145	215	290
20-4	45	110	250	-
20-5	35	110	250	325
20-6	70	145	215	290
20-15	80	-	-	280
20-17	90	180	270	-
20-18	35	110	250	325
20-19	90	180	270	-
20-21	35	110	250	325
20-23	35	110	250	325

Insert Arrangement	Degrees			
	W	X	Y	Z
20-24	35	110	250	325
20-27	35	110	250	325
20-29	80	-	-	280
22-1	35	110	250	325
22-2	70	145	215	290
22-4	35	110	250	325
22-5	35	110	250	325
22-8	35	110	250	325
22-9	70	145	215	290
22-10	35	110	250	325
22-11	35	110	250	325
22-13	35	110	250	325
22-20	35	110	250	325
22-22	-	110	250	-
22-23	35	-	250	-
22-27	80	-	250	280
22-28	80	-	-	280
22-36	90	-	270	-
24-2	80	-	-	280
24-9	35	110	250	325
24-10	80	-	-	280
24-11	35	110	250	325
24-22	45	110	250	-
24-27	80	-	-	280
28-2	35	110	250	325
28-3	70	145	215	290
28-5	35	110	250	325

Insert Arrangement	Degrees			
	W	X	Y	Z
28-6	70	145	215	290
28-7	35	110	250	325
28-12	90	180	270	-
28-18	70	145	215	290
28-22	70	145	215	290
32-2	70	145	215	290
32-5	35	110	250	325
32-7	80	125	235	280
32-8	80	125	235	280
32-15	35	110	250	280
32-17	45	110	250	-
32-73	36	-	-	-
36-3	70	145	215	290
36-4	70	145	215	290
36-5	-	120	240	-
36-6	35	110	250	325
36-9	80	125	235	280
36-10	80	125	235	280
36-14	90	180	270	-
36-15	60	125	245	305
36-52	72	144	216	288
40-1	65	130	235	300
40-9	65	125	225	310
40-56	72	144	216	288
44-52	72	135	225	288

# MIL-C-22992, QWLD

## contact arrangements

front face of pin insert or rear of socket insert illustrated

<b>Insert Arrangement</b>	12-5	12-48	12-49	14-3	14-53	16-2
<b>Service Rating</b>	D	A	A	A	Inst.	E
<b>Number of Contacts</b>	1	3	2	1	6	1
<b>Contact Size</b>	12	16	16	8	16	12

<b>Insert Arrangement</b>	16-7	16-9	16-10	16-11	16-12	16-13
<b>Service Rating</b>	A	A	A	A	A	A
<b>Number of Contacts</b>	1 2	2 2	3	2	1	2*
<b>Contact Size</b>	8 16	12 16	12	12	4	12

<b>Insert Arrangement</b>	16-61	18-1	18-3	18-4	18-5	18-6
<b>Service Rating</b>	A	B, C, F, G = A; Bal. = Inst.	D	D	D	D
<b>Number of Contacts</b>	7	10	2	4	2 1	1
<b>Contact Size</b>	16	16	12	16	12 16	4

<b>Insert Arrangement</b>	18-7	18-8	18-9	18-10	18-11	18-12
<b>Service Rating</b>	B	A	Inst.	A	A	A
<b>Number of Contacts</b>	1	1 7	2 5	4	5	6
<b>Contact Size</b>	8	12 16	12 16	12	12	16

\*A = Iron; B = Constantan



# MIL-C-22992, QWLD

## contact arrangements

front face of pin insert or rear of socket insert illustrated

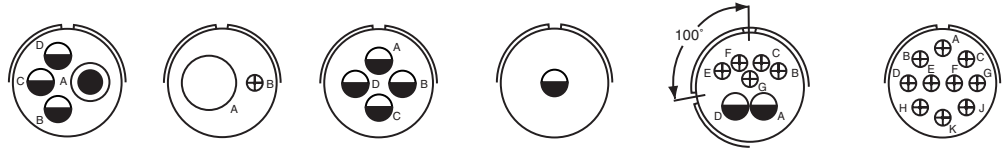

Insert Arrangement	18-13	18-14	18-15	18-16	18-17	18-19
Service Rating	A	A	A	C	Inst.	A
Number of Contacts	1 3	1 1	4**	1	2 5	10
Contact Size	8 12	4 16	12	12	12 16	16

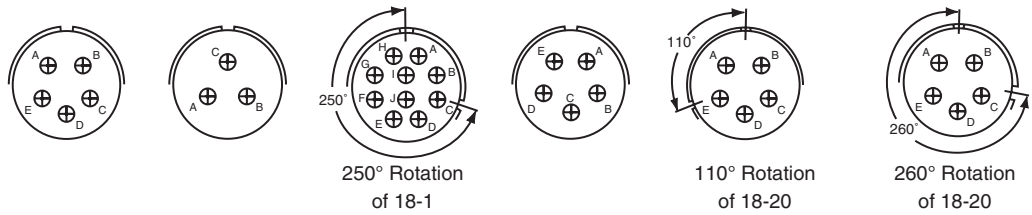

Insert Arrangement	18-20	18-22	18-24	18-29	18-30	18-31
Service Rating	A	D	B, C, F, G = A, Bal. = Inst.	A	A	A
Number of Contacts	5	3	10	5	5	5
Contact Size	16	16	16	16	16	16

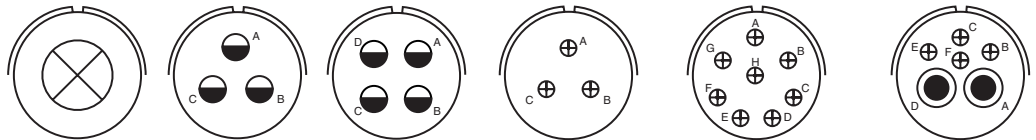

Insert Arrangement	20-2	20-3	20-4	20-6	20-7	20-8
Service Rating	D	D	D	D	A, B, H, G = D; C, D, E, F = A	Inst.
Number of Contacts	1	3	4	3	8	2 4
Contact Size	0	12	12	16	16	8 16

\*\*A, C = Iron; B, D = Constantan

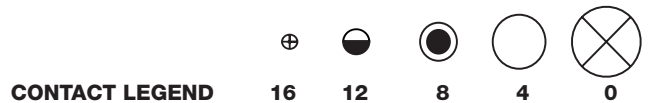

# MIL-C-22992, QWLD

## contact arrangements

front face of pin insert or rear of socket insert illustrated

<b>Insert Arrangement</b>	20-9	20-11	20-12	20-14	20-15	20-16
<b>Service Rating</b>	H = D; Bal. = A	Inst.	A	A	A	A
<b>Number of Contacts</b>	1 7	13	1 1	2 3	7	2 7
<b>Contact Size</b>	12 16	16	4 16	8 12	12	12 16

<b>Insert Arrangement</b>	20-17	20-18	20-19	20-20	20-21	20-22
<b>Service Rating</b>	A	A	A	A	A	A
<b>Number of Contacts</b>	5 1	3 6	3	1 3	1 8	3 3
<b>Contact Size</b>	12 16	12 16	8	4 12	12 16	8 16

	20-23	20-24	20-25	20-27	20-29	20-30
<b>Service Rating</b>	A	A	Inst.	A	A	Inst.
<b>Number of Contacts</b>	2	2 2	13	14	17	13
<b>Contact Size</b>	8	8 16	16	16	16	16



# MIL-C-22992, QWLD contact arrangements

front face of pin insert or rear of socket insert illustrated

<b>Insert Arrangements</b>	<b>20-33</b>	<b>22-1</b>	<b>22-2</b>	<b>22-4</b>	<b>22-5</b>
<b>Service Rating</b>	<b>A</b>	<b>D</b>	<b>D</b>	<b>A</b>	<b>D</b>
<b>Number of Contacts</b>	<b>11</b>	<b>2</b>	<b>3</b>	<b>2 2</b>	<b>2 4</b>
<b>Contact Size</b>	<b>16</b>	<b>8</b>	<b>8</b>	<b>8 12</b>	<b>12 16</b>

<b>Insert Arrangement</b>	<b>22-6</b>	<b>22-7</b>	<b>22-8</b>	<b>22-9</b>	<b>22-10</b>
<b>Service Rating</b>	<b>D</b>	<b>E</b>	<b>E</b>	<b>E</b>	<b>E</b>
<b>Number of Contacts</b>	<b>2 1</b>	<b>1</b>	<b>2</b>	<b>3</b>	<b>4</b>
<b>Contact Size</b>	<b>8 16</b>	<b>0</b>	<b>12</b>	<b>12</b>	<b>16</b>

<b>Insert Arrangement</b>	<b>22-11</b>	<b>22-12</b>	<b>22-13</b>	<b>22-14</b>	<b>22-15</b>
<b>Service Rating</b>	<b>B</b>	<b>D</b>	<b>E = D; A, B, C, D = A</b>	<b>A</b>	<b>D = E; A, B, C, E, F = A</b>
<b>Number of Contacts</b>	<b>2</b>	<b>2 3</b>	<b>4 1</b>	<b>19</b>	<b>5 1</b>
<b>Contact Size</b>	<b>16</b>	<b>8 16</b>	<b>12 16</b>	<b>16</b>	<b>12 16</b>

<b>CONTACT LEGEND</b>	<b>16</b>	<b>12</b>	<b>8</b>	<b>4</b>	<b>0</b>



# MIL-C-22992, QWLD

## contact arrangements

front face of pin insert or rear of socket insert illustrated

<b>Insert Arrangement</b>	<b>22-16</b>	<b>22-17</b>	<b>22-18</b>	<b>22-19</b>	<b>22-20</b>
<b>Service Rating</b>	<b>A</b>	<b>A = D; Bal. = A</b>	<b>A, B, F, G, H = D; C, D, E = A</b>	<b>A</b>	<b>A</b>
<b>Number of Contacts</b>	<b>3 6</b>	<b>1 8</b>	<b>8</b>	<b>14</b>	<b>9</b>
<b>Contact Size</b>	<b>12 16</b>	<b>12 16</b>	<b>16</b>	<b>16</b>	<b>16</b>

<b>Insert Arrangement</b>	<b>22-21</b>	<b>22-22</b>	<b>22-23</b>	<b>22-24</b>	<b>22-27</b>
<b>Service Rating</b>	<b>A</b>	<b>A</b>	<b>H = D; Bal. = A</b>	<b>C, D, E = D; A, B, F = A</b>	<b>J = D; Bal. = A</b>
<b>Number of Contacts</b>	<b>1 2</b>	<b>4</b>	<b>8</b>	<b>2 4</b>	<b>1 8</b>
<b>Contact Size</b>	<b>0 16</b>	<b>8</b>	<b>12</b>	<b>12 16</b>	<b>8 16</b>

<b>Insert Arrangement</b>	<b>22-28</b>	<b>22-33</b>	<b>22-34</b>	<b>22-36</b>	<b>24-2</b>
<b>Service Rating</b>	<b>A</b>	<b>A, B, C, D = D; E, F, G = A</b>	<b>D</b>	<b>H = D; Bal. = A</b>	<b>D</b>
<b>Number of Contacts</b>	<b>7</b>	<b>7</b>	<b>3 2</b>	<b>8</b>	<b>7</b>
<b>Contact Size</b>	<b>12</b>	<b>16</b>	<b>12 16</b>	<b>12</b>	<b>12</b>



# MIL-C-22992, QWLD

## contact arrangements

front face of pin insert or rear of socket insert illustrated

<b>Insert Arrangement</b>	24-3	24-5	24-6	24-7	24-9
<b>Service Rating</b>	D	A	A, G, H = D; Bal. = A	A	A
<b>Number of Contacts</b>	2 5	16	8	2 14	2
<b>Contact Size</b>	12 16	16	12	12 16	4

<b>Insert Arrangement</b>	24-10	24-11	24-12	24-16	24-17
<b>Service Rating</b>	A	A	A	A, B, F, G = D; C, D, E = A	D
<b>Number of Contacts</b>	7	3 6	2 3	1 3 3	2 3
<b>Contact Size</b>	8	8 12	4 12	8 12 16	12 16

<b>Insert Arrangement</b>	24-20	24-21	24-22	24-27	24-28
<b>Service Rating</b>	D	D	D	E	Inst.
<b>Number of Contacts</b>	2 9	1 9	4	7	24
<b>Contact Size</b>	12 16	8 16	8	16	16



# MIL-C-22992, QWLD

## contact arrangements

front face of pin insert or rear of socket insert illustrated

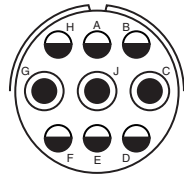

**28-1**  
**A, J, E = D; Bal. = A**  
**3 6**  
**8 12**

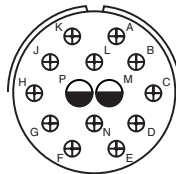

**28-2**  
**D**  
**2 12**  
**12 16**

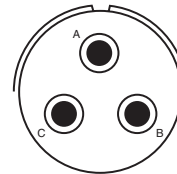

**28-3**  
**E**  
**3**  
**8**

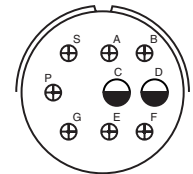

**28-4**  
**G, P, S = E; Bal. = D**  
**2 7**  
**12 16**

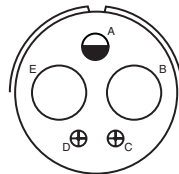

**Insert Arrangement**  
**Service Rating**  
**Number of Contacts**  
**Contact Size**

**28-5**  
**D**  
**2 1 2**  
**4 12 16**

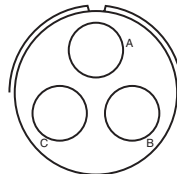

**28-6**  
**D**  
**3**  
**4**

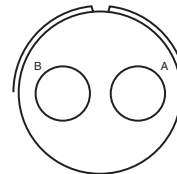

**28-7**  
**D**  
**2**  
**4**

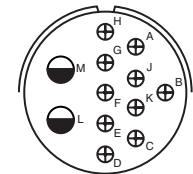

**28-8**  
**L, M = E; B = D; Bal. = A**  
**2 10**  
**12 16**

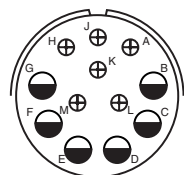

**Insert Arrangement**  
**Service Rating**  
**Number of Contacts**  
**Contact Size**

**28-9**  
**D**  
**6 6**  
**12 16**

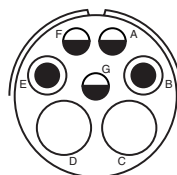

**28-10**  
**G = D; Bal. = A**  
**2 2 3**  
**4 8 12**

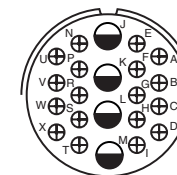

**28-11**  
**A**  
**4 18**  
**12 16**

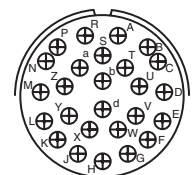

**28-12**  
**A**  
**26**  
**16**



# MIL-C-22992, QWLD contact arrangements

front face of pin insert or rear of socket insert illustrated

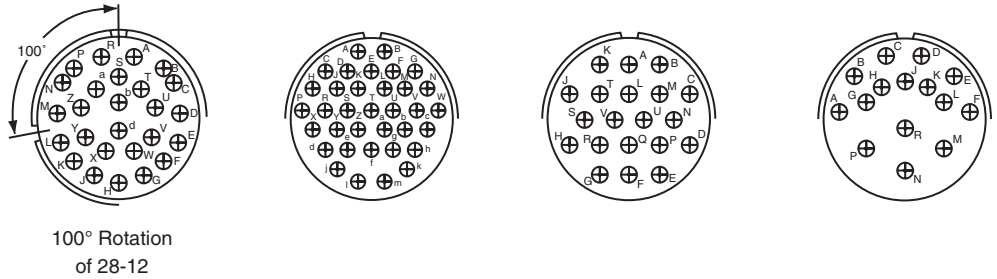

Insert Arrangement	28-13	28-15	28-16	28-17
Service Rating	A	A	A	R = B; M, N, P = D; A to L = A
Number of Contacts	26	35	20	15
Contact Size	16	16	16	16

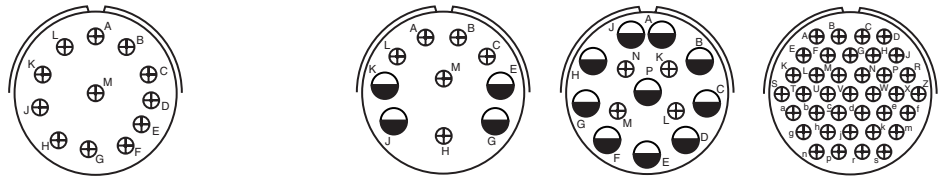

Insert Arrangement	28-18	28-19	28-20	28-21
Service Rating	M = C; G, H, J, K, L = D; A, B = H; Bal. = Inst.	H, M = B; A = D; Bal = A	A	A
Number of Contacts	12	4 6	10 4	37
Contact Size	16	12 16	12 16	16

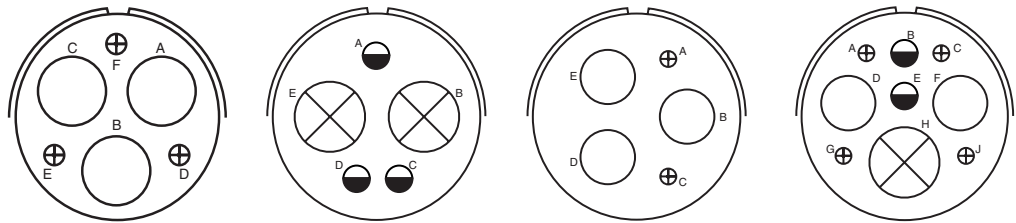

Insert Arrangement	28-22	32-1	32-2	32-3
Service Rating	D	A = E; Bal. = D	E	D
Number of Contacts	3 3	2 3	3 2	1 2 2 4
Contact Size	4 16	0 12	4 16	0 4 12 16



# MIL-C-22992, QWLD contact arrangements

front face of pin insert or rear of socket insert illustrated

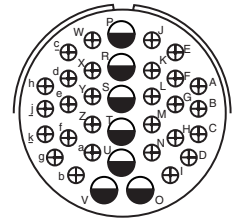
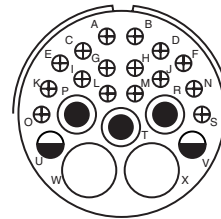
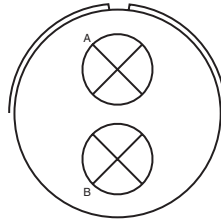
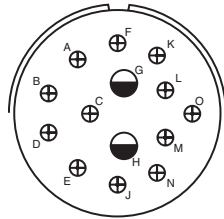

**Insert Arrangement**  
**Service Rating**  
**Number of Contacts**  
**Contact Size**

**32-4**  
F, J, K, N = A; Bal. = D  
2 12  
12 16

**32-5**  
D  
2  
0

**32-6**  
A  
2 3 2 16  
4 8 12 16

**32-7**  
A, B, h, j = Inst; Bal. = A  
7 28  
12 16

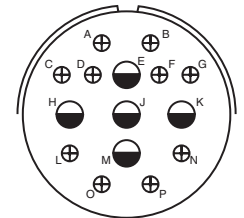
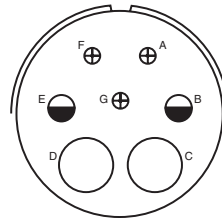
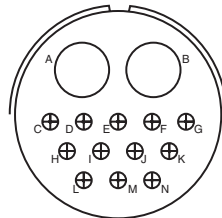
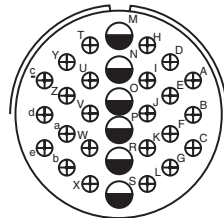

**Insert Arrangement**  
**Service Rating**  
**Number of Contacts**  
**Contact Size**

**32-8**  
A  
6 24  
12 16

**32-9**  
D  
2 12  
4 16

**32-10**  
A, F = E, G = B; B, E = D; C, D = A  
2 2 3  
4 8 16

**32-12**  
C, D, E, F, G = A; Bal. = D  
5 10  
12 16

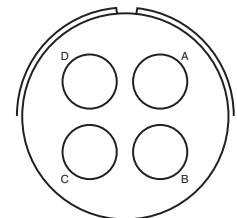
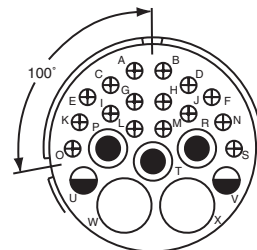
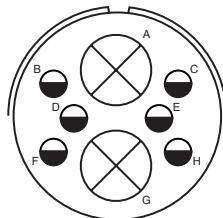
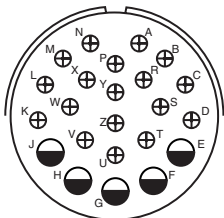

**Insert Arrangement**  
**Service Rating**  
**Number of Contacts**  
**Contact Size**

**32-13**  
D  
5 18  
12 16

**32-15**  
D  
2 6  
0 12

**32-16**  
A  
2 3 2 16  
4 8 12 16

**32-17**  
D  
4  
4

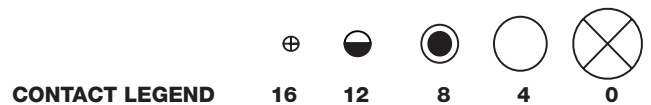

# MIL-C-22992, QWLD contact arrangements

front face of pin insert or rear of socket insert illustrated

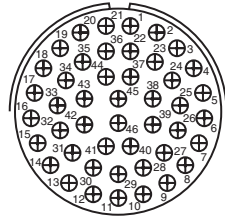

Insert Arrangement  
Service Rating  
Number of Contacts  
Contact Size

32-73  
A  
46  
16

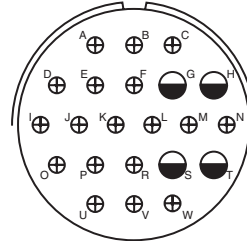

36-1  
D  
4 18  
12 16

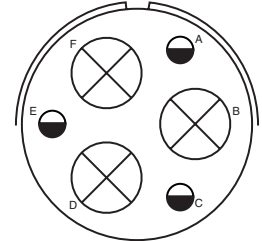

36-3  
D  
3 3  
0 12

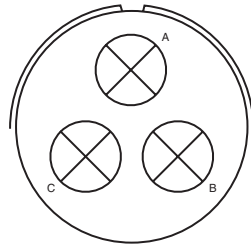

Insert Arrangement  
Service Rating  
Number of Contacts  
Contact Size

36-4  
A = D; B, C = A  
3  
0

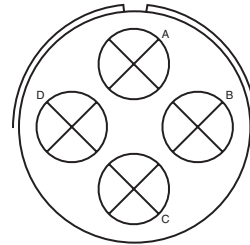

36-5  
A  
4  
0

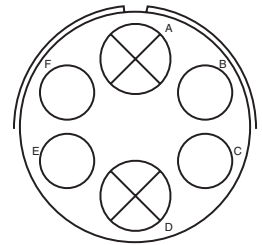

36-6  
A  
2 4  
0 4

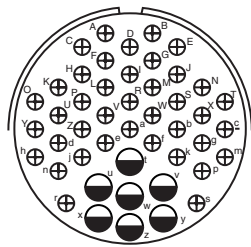

Insert Arrangement  
Service Rating  
Number of Contacts  
Contact Size

36-7  
A  
7 40  
12 16

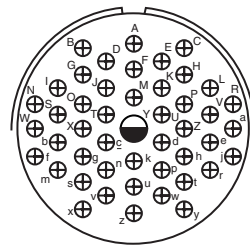

36-8  
A  
1 46  
12 16

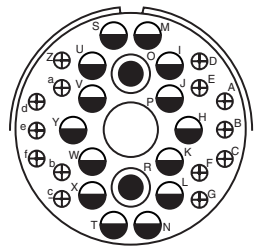

36-9  
A  
1 2 14 14  
4 8 12 16

## CONTACT LEGEND

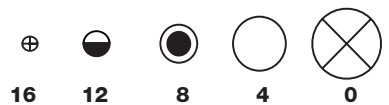

# MIL-C-22992, QWLD contact arrangements

front face of pin insert or rear of socket insert illustrated

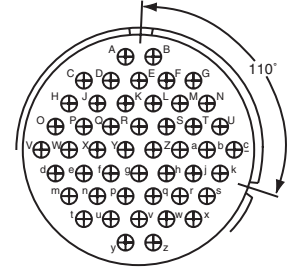
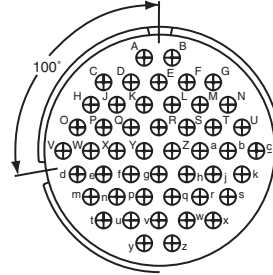
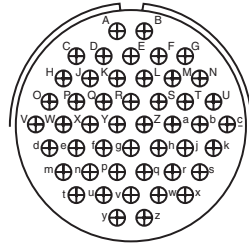

**Insert Arrangement** 36-10  
**Service Rating** A  
**Number of Contacts** 48  
**Contact Size** 16

100° Rotation  
of 36-10

**36-11**  
**A**  
**48**  
**16**

110° Rotation  
of 36-10

**36-12**  
**A**  
**48**  
**16**

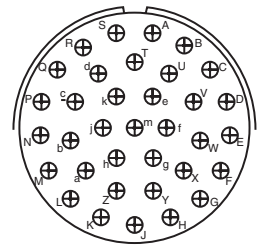
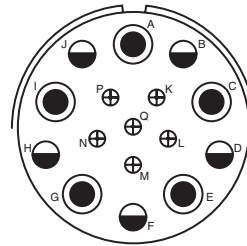
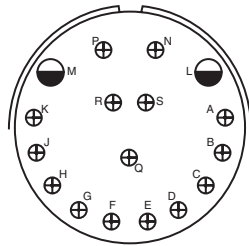

**Insert Arrangement** 36-13  
**Service Rating** N, P, Q = E; Bal. = A  
**Number of Contacts** 2 15  
**Contact Size** 12 16

**36-14**  
**D**  
**5 5 6**  
**8 12 16**

**36-15**  
**M = D; Bal. = A**  
**35**  
**16**

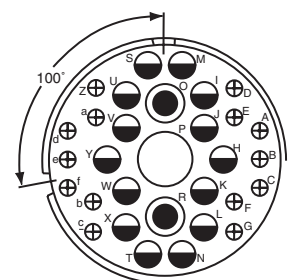
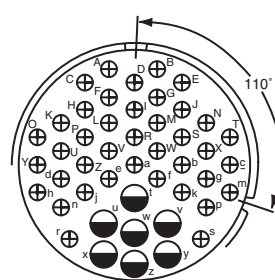
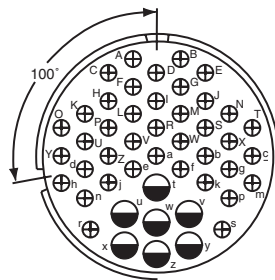

**Insert Arrangements** 36-16  
**Service Rating** A  
**Number of CContacts** 7 40  
**Contact Size** 12 16

100° Rotation  
of 36-7

**36-17**  
**A**  
**7 40**  
**12 16**

110° Rotation  
of 36-7

**36-18**  
**A**  
**1 2 14 14**  
**4 8 12 16**

**CONTACT LEGEND**

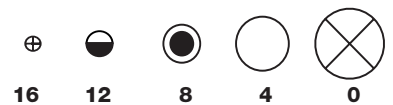

# MIL-C-22992, QWLD contact arrangements

front face of pin insert or rear of socket insert illustrated

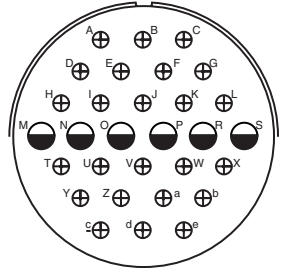
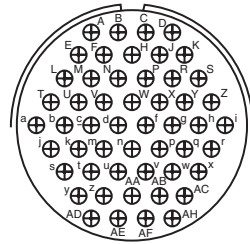
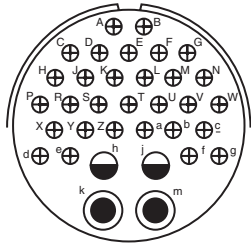

**Insert Arrangement**  
**Service Rating**  
**Number of Contacts**  
**Contact Size**

**36-20**  
**A**  
**2 2 30**  
**8 12 16**

**36-52**  
**A**  
**52**  
**16**

**40-1**  
**D**  
**6 24**  
**12 16**

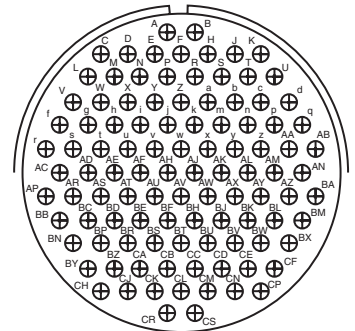
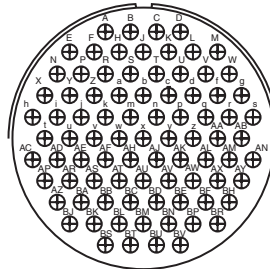
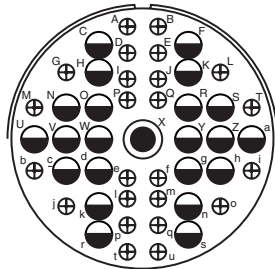

**Insert Arrangement**  
**Service Rating**  
**Number of Contacts**  
**Contact Size**

**40-9**  
**A**  
**1 22 24**  
**8 12 16**

**40-56**  
**A**  
**85**  
**16**

**44-52**  
**A**  
**104**  
**16**

**CONTACT LEGEND**

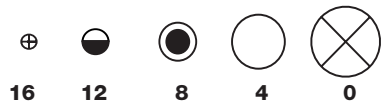







# QWLD

## special arrangements

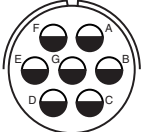
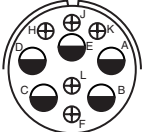

Ever expanding requirements for more complex circuits in ground equipment and elevated altitude applications has prompted Amphenol to provide inserts not covered by the MS drawings. Pictured here and on the following pages are insert layouts which have anywhere from one contact

(high tension) to the 78 contact insert in shell size 48. Many of these special inserts are also available in alternate keyway positions. Please contact Amphenol, Sidney, NY or your local Amphenol sales office for arrangements particular to your circuit application.

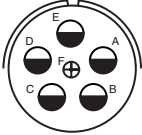
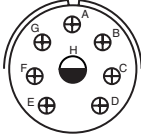
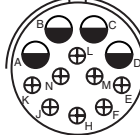
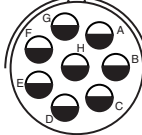

front face of pin insert or rear of socket insert illustrated

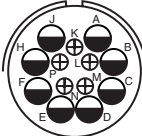
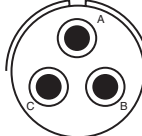
					
<b>Insert Arrangement</b>	16-59	20-51	20-57	20-58	20-59
<b>Service Rating</b>	A	A	A	A	A
<b>Number of Contacts</b>	4	3*	7*	5 5	3*
<b>Contact Size</b>	12	8	12 for #14 or 16 wire	12 16	8 for #10 or 12 wire

				
<b>Insert Arrangement</b>	20-66	20-79	22-63	22-65
<b>Service Rating</b>	A	H = D; Bal. = A	A	H = D; Bal. = A
<b>Number of Contacts</b>	1 5	7* 1*	4 8	8*
<b>Contact Size</b>	16 12 or #10 wire	16 12 for #16 wire	12 16	12 for #14 or 16 wire

				
<b>Insert Arrangement</b>	22-70	22-80	24-51	24-52
<b>Service Rating</b>	A	A	A	Hi-Volt
<b>Number of Contacts</b>	8 5	3*	5*	1
<b>Contact Size</b>	12 16	8 for #10 or 12 wire	B, E for AN #10 or 12 wire A, C, D for AN #8 wire	12

\*Solderless

					
<b>CONTACT LEGEND</b>	16	12	8	4	0

# QWLD

## special arrangements

front face of pin insert or rear of socket insert illustrated

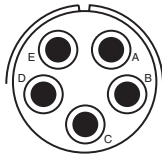

**24-53**  
**A**  
**5\***  
**8**

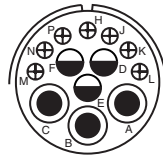

**24-58**  
**A**  
**3 3 7**  
**8 12 16**

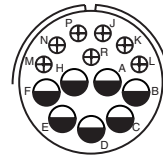

**24-59**  
**A**  
**7 7**  
**12 16**

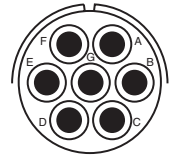

**24-60**  
**A**  
**7\***  
**8 for #10 or 12 wire**

**Insert Arrangement**  
**Service Rating**  
**Number of Contacts**  
**Contact Size**

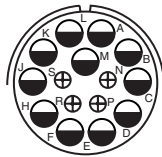

**24-65**  
**A**  
**11 4**  
**12 16**

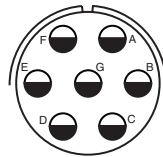

**24-66**  
**D**  
**7**  
**12**

**Insert Arrangement**  
**Service Rating**  
**Number of Contacts**  
**Contact Size**

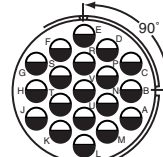

**24-67**  
**Inst.**  
**19**  
**12**

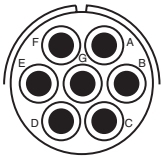

**24-71**  
**A**  
**2\* 5\***  
**8 8 for #10 or 12 wire**

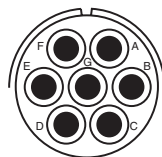

**24-75**  
**A**  
**5 2**  
**8 8 for #16 wire**

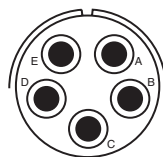

**24-79**  
**A**  
**5**  
**8**

**Insert Arrangement**  
**Service Rating**  
**Number of Contacts**  
**Contact Size**

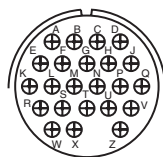

**24-80**  
**Inst.**  
**23**  
**16**

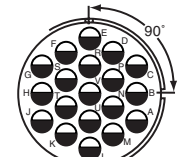

**24-84**  
**A**  
**1 18**  
**12 12 (Coax) RG-188/U**  
**or RG-174/U**

\*Solderless



# QWLD

## special arrangements

front face of pin insert or rear of socket insert illustrated

<b>Insert Arrangement</b>	<b>28-51</b>	<b>28-59</b>	<b>28-66</b>	<b>28-72</b>
<b>Service Rating</b>	<b>A</b>	<b>A</b>	<b>A</b>	<b>-</b>
<b>Number of Contacts</b>	<b>12</b>	<b>7 10</b>	<b>2 14</b>	<b>3</b>
<b>Contact Size</b>	<b>12</b>	<b>12 16</b>	<b>8 12</b>	<b>4 (Coax) RG-59A/U or RG-62A/U</b>
<b>Insert Arrangement</b>	<b>28-74</b>	<b>28-75</b>	<b>28-79</b>	<b>28-82</b>
<b>Service Rating</b>	<b>A</b>	<b>A</b>	<b>A</b>	<b>D</b>
<b>Number of Contacts</b>	<b>9* 4* 3*</b>	<b>9* 7*</b>	<b>7 9</b>	<b>2 4</b>
<b>Contact Size</b>	<b>16 8 8 for #10 wire (S, T, R)</b>	<b>16 8 for #10 wire</b>	<b>8 16</b>	<b>8 12</b>
<b>Insert Arrangement</b>	<b>28-84</b>	<b>32-52</b>	<b>32-53</b>	<b>32-56</b>
<b>Service Rating</b>	<b>A</b>	<b>D</b>	<b>t, u = E; Bal. = Inst.</b>	<b>A</b>
<b>Number of Contacts</b>	<b>9</b>	<b>6 2</b>	<b>5 37</b>	<b>24 6</b>
<b>Contact Size</b>	<b>8</b>	<b>12 0</b>	<b>12 16</b>	<b>16 12 for #10 wire</b>

\*Solderless

**CONTACT LEGEND**

<b>16</b>	<b>12</b>	<b>8</b>	<b>4</b>	<b>0</b>

# QWLD

## special arrangements

front face of pin insert or rear of socket insert illustrated

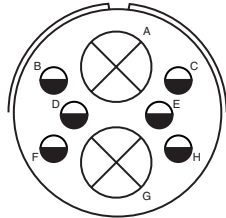

32-57

\*\*

Insert Arrangement  
Service Rating  
Number of Contacts  
Contact Size

6 2  
12 0 (Coax) RG-71/U

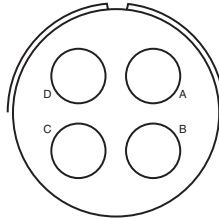

32-58

-

4 (Coax) RG-161U  
or RG-179/U

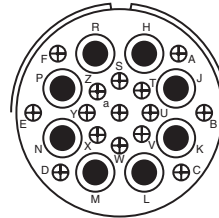

32-60

A

15 8  
16 8 (Coax) RG-124/U

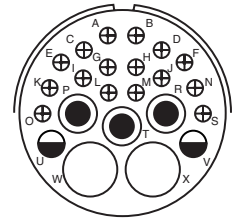

32-62

\*\*

2 1 2 16 2  
4 8 12 16 8 (Coax)RG-124/U

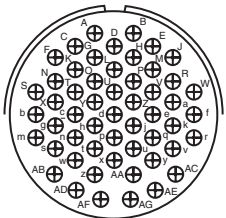

32-64

Inst.

Insert Arrangement  
Service Rating  
Number of Contacts  
Contact Size

54  
16

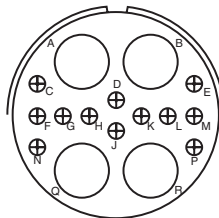

32-68

A

12 4  
16 4 (Coax) RG-58C/U

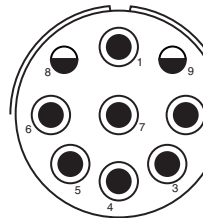

32-75

8, 9 = D

2 7  
12 8 (Coax) RG-180B/U

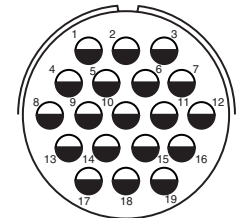

32-76

A

19  
12

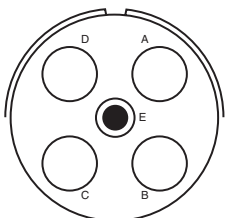

32-79

D

Insert Arrangement  
Service Rating  
Number of Contacts  
Contact Size

4 1  
4 8

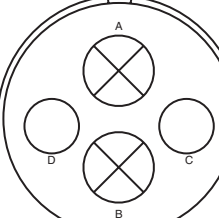

36-51

D

2 2  
0 4

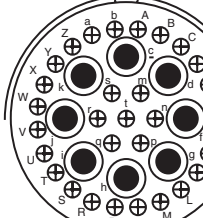

36-54

A

8 31  
8 16

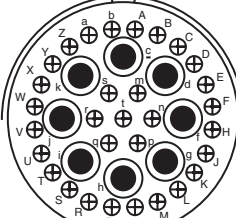

36-55

A

31 8  
16 8 for #6 wire

\*\*Consult Sidney, NY for service rating of power contacts.

### CONTACT LEGEND

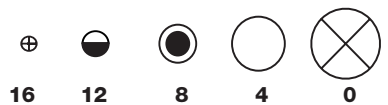

# QWLD special arrangements

front face of pin insert or rear of socket insert illustrated

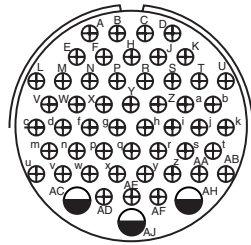

**36-59**

**A**

**50 3**

**16 12 for #10 wire**

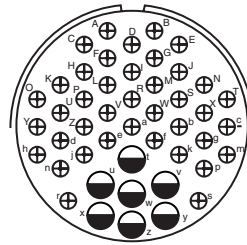

**36-60**

**\*\***

**40 7**

**16 12 for #10 wire**

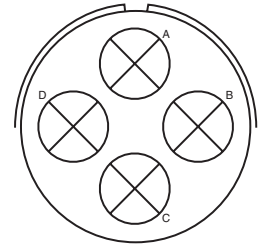

**36-64**

**-**

**4**

**0 (Coax) RG-11/U  
RG-12/U or RG-13/U**

**Insert Arrangement**  
**Service Rating**  
**Number of Contacts**  
**Contact Size**

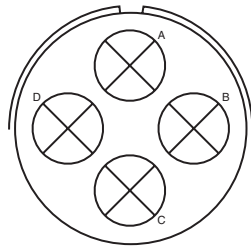

**36-65**

**-**

**4**

**0 (Coax) RG-59/U, RG-62/U  
or RG-71/U**

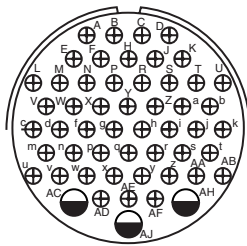

**36-71**

**A**

**3 50**

**12 16**

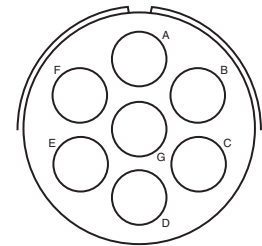

**36-73**

**-**

**7**

**4 (Coax) RG-62B/U**

**Insert Arrangement**  
**Service Rating**  
**Number of Contacts**  
**Contact Size**

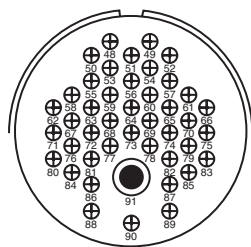

**36-74**

**A**

**43 1**

**16 8 (Coax) RG-187/U**

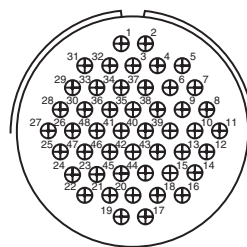

**36-75**

**A**

**48**

**16 for #14 wire**

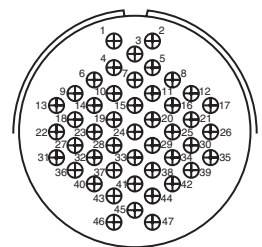

**36-76**

**A**

**47**

**16**

**Insert Arrangement**  
**Service Rating**  
**Number of Contacts**  
**Contact Size**

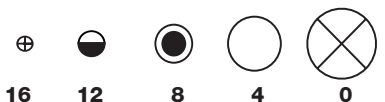

**CONTACT LEGEND**

**16**

**12**

**8**

**4**

**0**

\*\*Consult Sidney, NY for service rating of power contacts.

# QWLD

## special arrangements

front face of pin insert or rear of socket insert illustrated

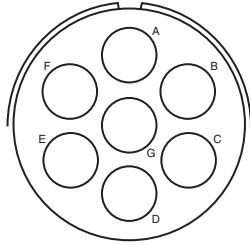

Insert Arrangement  
Service Rating  
Number of Contacts  
Contact Size

36-77  
D  
7  
4

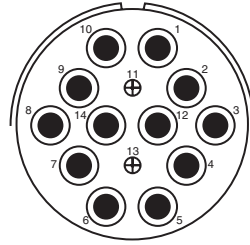

36-78  
A  
2 12  
16 8

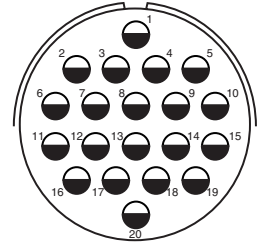

36-79  
A  
20  
12

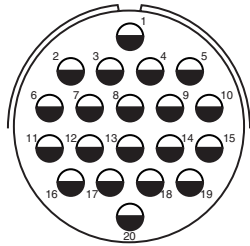

Insert Arrangement  
Service Rating  
Number of Contacts  
Contact Size

36-80  
A  
20  
12 for #10 wire

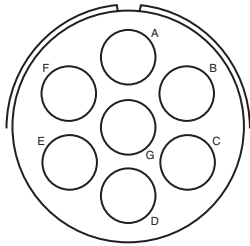

36-83  
-  
7  
4 (Coax) RG-58/U

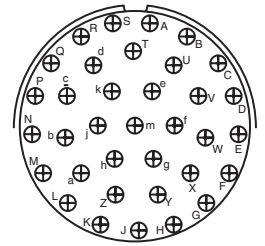

36-85  
M = D; Bal. = A  
35  
16 for #12 wire

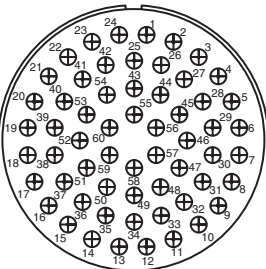

Insert Arrangement  
Service Rating  
Number of Contacts  
Contact Size

40-53  
A  
60  
16

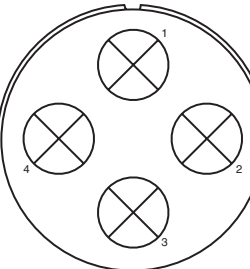

40-57  
E  
4  
0

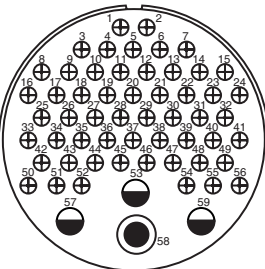

40-61  
A  
1 3 55  
8 12 16

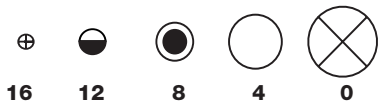

CONTACT LEGEND

# QWLD special arrangements

front face of pin insert or rear of socket insert illustrated

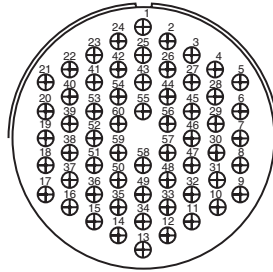

**Insert Arrangement** 40-62  
**Service Rating** A  
**Number of Contacts** 60  
**Contact Size** 16

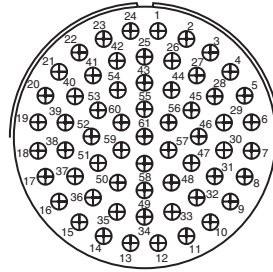

**Insert Arrangement** 40-63  
**Service Rating** A  
**Number of Contacts** 61  
**Contact Size** 16 for #14 wire

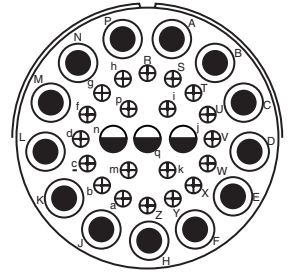

**Insert Arrangement** 40-64  
**Service Rating** -  
**Number of Contacts** 3 20 13  
**Contact Size** 12 16 8 (Coax) RG-124/U

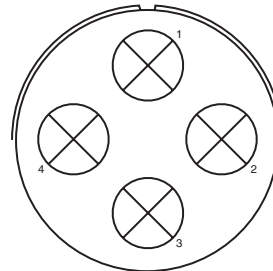

**Insert Arrangement** 40-66  
**Service Rating** -  
**Number of Contacts** 4  
**Contact Size** 0 (Coax) RG-63B/U

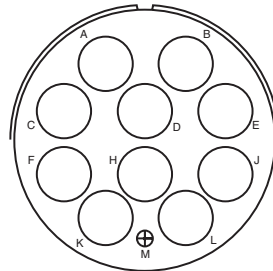

**Insert Arrangement** 40-67  
**Service Rating** A  
**Number of Contacts** 1 10  
**Contact Size** 16 4 (Coax) RG-59/U

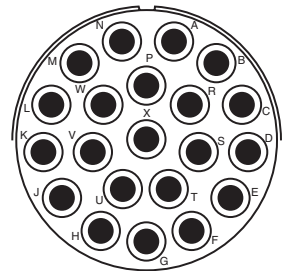

**Insert Arrangement** 40-68  
**Service Rating** A  
**Number of Contacts** 21  
**Contact Size** 8

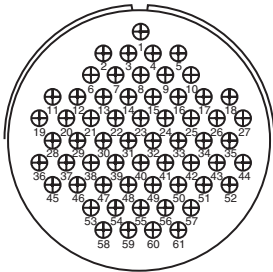

**Insert Arrangement** 40-70  
**Service Rating** A  
**Number of Contacts** 61  
**Contact Size** 16

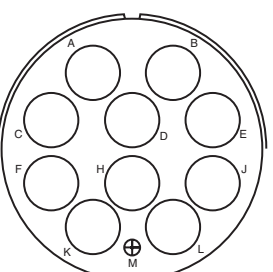

**Insert Arrangement** 40-72  
**Service Rating** A  
**Number of Contacts** 1 10  
**Contact Size** 16 4 (Coax) RG-9B/U

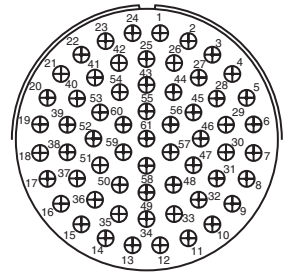

**Insert Arrangement** 40-73  
**Service Rating** A  
**Number of Contacts** 61  
**Contact Size** 16

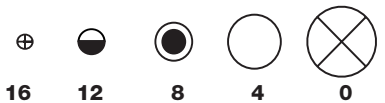

**CONTACT LEGEND**

16

12

8

4

0

# QWLD special arrangements

front face of pin insert or rear of socket insert illustrated

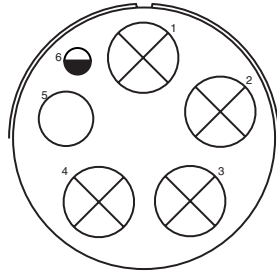

40-74

A

1 1 4  
12 4 (Coax) RG-62/U 0 (Coax) RG-9B/U  
or RG-214/U

Insert Arrangement  
Service Rating  
Number of Contacts  
Contact Size

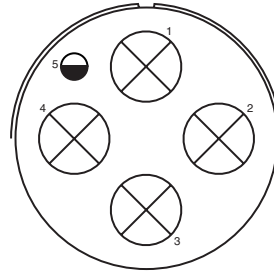

40-75

E

1 4  
12 0

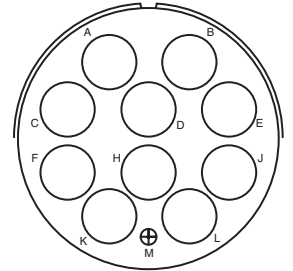

40-80

A

1 10  
16 4

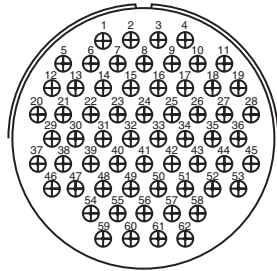

40-81

A

62  
16 for #14 wire

Insert Arrangement  
Service Rating  
Number of Contacts  
Contact Size

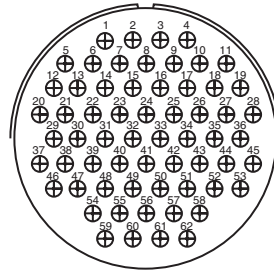

40-82

A

62  
16

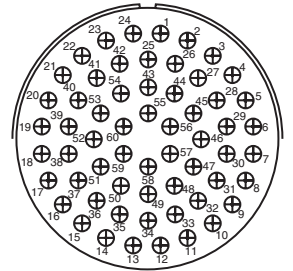

40-85

A

60  
16 for #14 wire

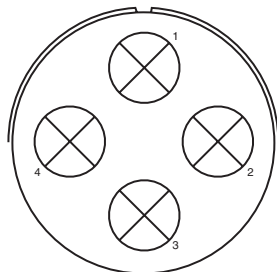

40-86

-

4  
0 (Coax) RG-115A/U

Insert Arrangement  
Service Rating  
Number of Contacts  
Contact Size

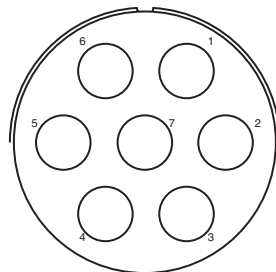

40-87

D

7  
4

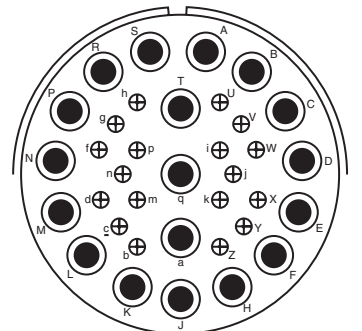

44-53

A

18 18  
16 8 (Coax) RG-124/U

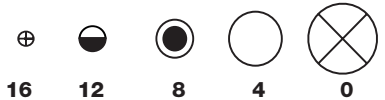

CONTACT LEGEND

16

12

8

4

0



# QWLD special arrangements

front face of pin insert or rear of socket insert illustrated

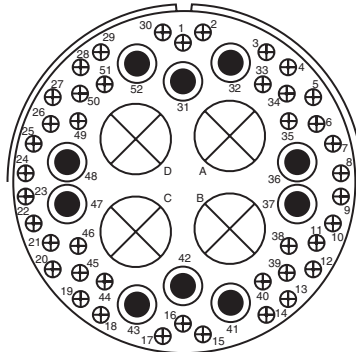

48-51†

A

Insert Arrangement  
Service Rating  
Number of Contacts  
Contact Size

42 10 4  
16 8 0 (Coax) RG-41/U

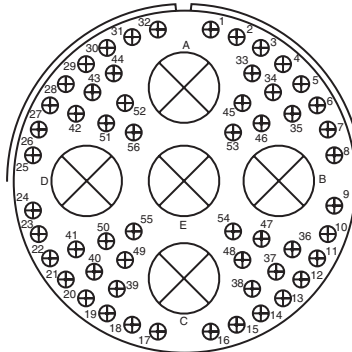

48-52†

A

56 5  
16 0 (Coax) RG-41/U

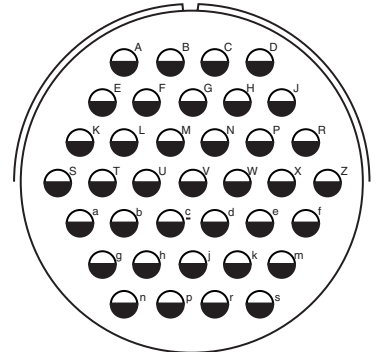

48-53†

D

37  
12

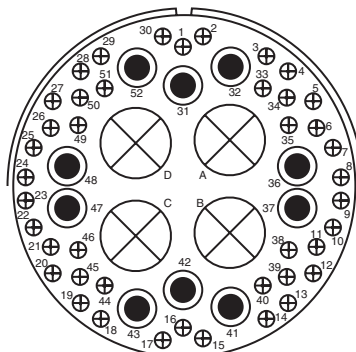

48-54†

A

Insert Arrangement  
Service Rating  
Number of Contacts  
Contact Size

42 10 4  
16 8 0 (Coax) RG-59/U

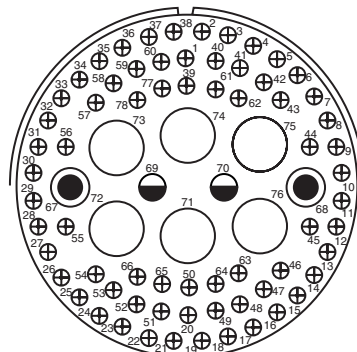

48-55†

A

68 2 2 6  
16 12 8 4

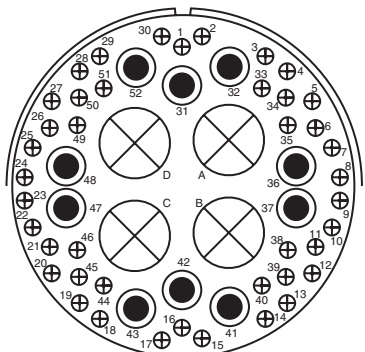

48-57†

A

42 10 4  
16 8 0

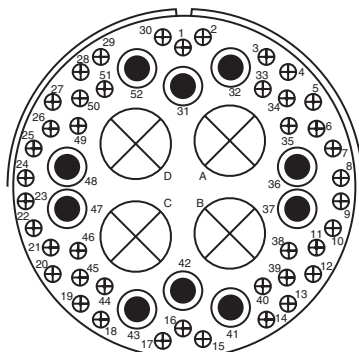

48-60†

A

Insert Arrangement  
Service Rating  
Number of Contacts  
Contact Size

42 10 4  
16 8 0 (Coax) RG-214/U

†Consult Sidney, NY for availability

**CONTACT LEGEND**

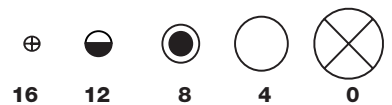

# QWLD

## thermocouple contact availability

A complete line of cylindrical connectors containing thermocouple insert arrangements is available. The contact layout for a particular arrangement will be found in either the MIL-C-22992, QWLD contact arrangement section, pages 27-38, or the Special contact arrangement section, pages 39-47. All thermocouple contact layouts may contain either iron, alumel, chromel, constantan, standard (copper) or brass (dummy) contacts. See the thermocouple tabulations on the following pages.

The following abbreviations are used in the contact material column in the charts that follow. Also, thermocouple contacts are color coded as shown. (This identification is made by means of small dots of stain on solder well end of the contact.)

Abbreviation	Material	Color Code
Ir.	Iron	Black
Con	Constantan	Yellow
Cu.	Copper Alloy	N/A
Ch.	Chromel	White
Al.	Alumel	Green
Dummy	Brass	N/A

### WIRE WELL DATA

Contact Size	Well Inside Dia. + .004 - .002	Well Depth + .031 - .000	Solder Well Barrel Outside Dia.
12	.125	.250	.166 ±.003
16	.094	.188	.125 +.002 -.004

### RECOMMENDED WIRE

I Chromel-Alumel	Use wire in accordance with MIL-W-5848
II Iron-Constantan	Use wire in accordance with MIL-W-5845

# QWLD

## thermocouple arrangements

Shell Size and Arrg.	Similar to MS Arrg.	Total Contacts	Contact Size		Pin Insert Rotation CW	Contact Material
			12	16		
14-59	14-53	6		6	None	A = Al.; B = Ch.; C = Ir.; D = Con.; E,F = Cu.
16-52	16-11	2	2		90°	A = Al.; B = Ch.
16-53	16-9	4	2	2	70°	A = Al.; C = Ch.; B, D = Cu.
16-55	16-10	3	3		45°	A = Al.; B = Ch.; C = Cu.
16-56	16-13	2	2		90°	A = Con.; B = Cu.
16-57	16-10	3	3		None	A = Al.; B = Cu.; C = Ch.
16-58	16-10	3	3		None	A = Con.; B, C = Cu.
16-60	16-13	2	2		None	A = Al.; B = Ch.
16-62	16-11	2	2		None	A = Con.; B = Cu.
16-67	16-11	2	2		None	A = Al.; B = Ch.
16-68	16-9	4	2	2	None	A, B, C = Ch.; D = Al.
18-51	18-12	6		6	None	A = Ir.; B, E = Con.; D = Cu.; C, F = Dummy
18-52	18-11	5	5		None	A = Ir.; B = Con.; C = Ch.; D = Al.; E = Dummy
18-53	18-12	6		6	None	A, D = Ir.; B, E = Con.; C, F = Dummy
18-54	18-15	4	4		None	A, C = Al.; B, D = Ch.
18-56	18-1	10		10	45°	A, C, E, G, I = Ir.; B, D, F, H, J = Con
18-57	18-12	6		6	45°	A, C, E = Al.; B, D, F = Ch.
18-59	18-12	6		6	45°	A, C = Ir.; B, E, F = Con.; D = Cu.
18-60	18-11	5	5		45°	A, D = Al.; B, C = Ch.; E = Al.
18-61	18-12	6		6	None	A, C = Ir.; B, D = Con.; E = Ch.; F = Al.
18-62	18-12	6		6	None	A, B, D = Ir.; D, E, F = Con.
18-63	18-15	4	4		None	A, C = Con.; B, D = Cu.
18-65	18-12	6		6	None	A = Ir.; B = Con.; Balance = Cu.
18-66	18-1	10		10	None	A, C, E, G, I = Cu.; B, D, F, H, J = Con.
18-67	18-12	6		6	None	A, C, E = Cu.; B, D, F = Con.
18-68	18-11	5	5		None	A, D = Al.; B, C = Ch.; E = Cu.
18-69	18-1	10		10	None	A = Al.; B = Ch.; Balance = Cu.
18-70	18-11	5	5		None	A = Ir.; B = Con.; C = Ch.; D = Al.; E = Cu.
18-71	18-15	4	4		None	A = Con.; Balance = Cu.
18-72	18-15	4	4		None	D = Con.; Balance = Cu.
18-73	18-9	7	2	5	None	A = Al.; D = Ch; Balance = Cu.
18-74	18-12	6		6	None	A = Ch.; B = Al.; D = Ir.; E = Cu.; C, F = Con.
18-76	18-1	10		10	None	A, C, E, G, I = Al.; B, D, F, H, J = Ch.
18-77	18-1	10		10	None	A, C, E, G = Al.; B, D, F, H = Ch.; Bal. = Cu.
18-78	18-1	10		10	None	A = Al.; B = Ch.; D, F, H, J = Con.; Bal. = Cu.
18-79	18-12	6		6	None	A, F = Ir.; B, E = Con.; C, D = Cu.
18-80	18-15	4	4		None	A, C = Cu.; B, D = Con.
18-81	18-1	10		10	None	E, G = Con.; Bal. = Cu.
18-82	18-1	10		10	None	E, G = Con.; F, H = Ir.; Bal = Cu.
20-52	20-4	4	4		315°	A= Ir.; B = Con.; C = Ch.; D = Al
20-56	20-7	8		8	45°	A, B, G, H = Ir.; C, D, E, F = Con.
20-60	20-7	8		8	45°	D = Ch.; E = Al.; Balance = Cu.
20-61	20-29	17		17	45°	A, B, M = Cu.; Balance = Con.
20-62	20-15	7	7		80°	A, C, E, = Al.; B, D, F, = Ch.; G = Cu.

# QWLD

## thermocouple arrangements

Shell Size and Arrg.	Similar to MS Arrg.	Total Contacts	Contact Size		Pin Insert Rotation CW	Contact Material
			12	16		
20-64	20-27	14		14	None	A = Al.; C = Ch.; Balance = Cu.
20-65	20-27	14		14	None	A, B, C, D, E, F, G = Ir.; H, I, J, K, L, M, N = Con.
20-67	20-16	9	2	7	None	H = Al.; I = Ch.; Balance = Cu.
20-68	20-7	8		8	None	A, B, G, H = Con.; C, D, E, F = Cu.
20-69	20-27	14		14	None	A, B, C, D, E, F, G = Cu.; H, I, J, K, L, M, N = Con.
20-70	20-29	17		17	None	A, C, E, G, J, L, N, R, T = Ir.; B, D, F, H, K, M, P, S = Con.
20-71	20-29	17		17	None	S = Al.; R = Ch.; Balance = Cu.
20-74	20-29	17		17	None	A, C, E, G, J, L, N, R = Ir.; B, D, F, H, K, M, P, S = Con.; T = Cu.
20-75	20-15	7	7		None	G = Al.; Balance = Ch.
20-77	20-16	9	2	7	None	A = Con.; Balance = Std.
20-80	20-27	14		14	None	A, C, E, G, I, K, M = Cu.; B, D, F, H, J, L, N = Con.
20-81	20-27	14		14	None	A, C, E, G, I, K, M = Ch.; B, D, F, H, J, L, N = Al
20-82	20-29	17		17	None	A, C, E, G, J, L, N, R = Al.; B, D, F, H, K, M, P, S = Ch.; T = Cu.
20-85	20-33	11		11	None	K, L = Al.; Bal. = Ch.
20-87	20-29	17		17	None	A, C, E, G, J, L, N, R = Con.; Bal. = Cu.
20-88	20-27	14		14	None	A, C, E = Al.; B, D, F = Ch.; G, H, K, N = Con.; Bal. = Cu.
20-89	20-27	14		14	None	B, D, F, H, J, L = Al.; A, C, E, G, I, K = Ch., M, N = Cu.
20-90	20-27	14		14	None	C, G, I = Ch.; K, L, M = Al.; Bal. = Cu.
20-91	20-27	14		14	None	I = Ch.; K = Al.; Bal. = Cu.
20-92	20-7	8		8	None	A = Al.; H = Cu.; Bal. = Ch.
20-93	20-27	14		14	None	A = Ch.; B = Al.; Bal. = Cu.
20-94	20-15	7	7		None	A, C, E = Al.; B, D, F = Ch.; G = Cu.
20-99	20-33	11		11	None	A = Al.; Bal. = Ch.
22-57	22-14	19		19	45°	A, C, E, G, J, L, N, R = Ir.; B, D, F, H, K, M, P, S = Con.; T, U, V = Cu.
22-60	22-14	19		19	45°	U = Al.; N = Ch.; Bal. = Cu.
22-62	22-23	8	8		60°	A, B, F, G = Al.; C, D, E, H = Ch.
22-68	22-19	14		14	45°	A, C, E, G, J, L, M = Ir.; B, D, F, H, K, P, N = Con.
22-69	22-19	14		14	45°	A, C, E, G, J, L, M = Cu.; B, D, F, H, K, P, N = Con.
22-71	22-14	19		19	None	V = Al.; U = Ch.; Balance = Cu.
22-72	22-5	6	2	4	None	B = Al.; E = Ch.; Balance = Cu.
22-73	22-5	6	2	4	None	E = Al.; B = Ch.; Balance = Cu.
22-74	22-23	8	8		None	A, C, E, G = Ir.; B, D, F, H = Con.
22-75	22-23	8	8		None	A = Al.; B, D, G, H = Cu.; C = Ch.; E = Ir.; F = Con
22-76		21		21	None	W = Con.; Balance = Cu.
22-77	22-19	14		14	None	B, D, F, H, J, K, M, P = Cu.; A, E, L = Ir.; C, G, N = Con.
22-78	22-14	19		19	None	A, C, E, G, H, K, M, P, R, T = Con.; Balance = Cu.
22-79	22-10	4		4	None	A, C = Con.; B, D = Cu.
22-82	22-14	19		19	None	A, C, E, G, J, L, N, R, T = Ir.; B, D, F, H, K, M, P, S, U = Con.; V = Cu.
22-83	22-18	8		8	None	A, C, E, G = Al.; B, D, F, H = Ch.
22-84	22-14	19		19	None	A, C, S = Ch.; B, D, T = Al.; Bal. = Cu.
22-85	22-19	14		14	None	A, C, E, G, J, L, N = Al.; B, D, F, H, K, M, P = Ch.
22-89	22-88	7	7		None	A, C, E = Ir.; B, D, F = Con.; G = Cu.
24-56	24-20	11	2	9	45°	E = Al.; F = Ch.; Balance = Cu.
24-57	24-26	24		24	45°	A, C, J, V, Y, W, K, E, H, U, S, M = Ch.; Balance = Al
24-62	24-28	24		24	None	A, C, E, G = Ir.; B, D, F, H = Con.; R, T = Ch.; S, U = Al.; Balance = Cu.

# QWLD

## thermocouple arrangements

Shell Size and Arrg.	Similar to MS Arrg.	Total Contacts	Contact Size		Pin Insert Rotation CW	Contact Material
			12	16		
24-63	24-28	24		24	None	A, C, E, G, J, L, K, N, S, U, W, Y = Cu.; B, D, F, H, Q, R, M, P, T, V, X, Z = Con.
24-64	24-5	16		16	None	A, B, C, D, E, F, G, H = Ir.; J, K, L, M, N, P, R, S = Con.
24-68	24-28	24		24	None	D = Con.; Balance = Cu.
24-81	24-7	16	2	14	None	A, C, E, G, I, K, M, N, P = Cu.; B, D, F, H, J, L, O = Con.
24-88	24-28	24		24	None	A, B, C, D, E, F, G, H, J, K, L, M = Con.; Bal. = Ir.
24-91	24-5	16		16	None	A, B, C, D, E, F, G, H = Al.; J, K, L, M, N, P, R, S = Ch.
28-53	28-11	22	4	18	45°	J, L = Al.; K, M = Ch.; Balance = Cu.
28-58	28-20	14	10	4	45°	A, C, E, G, K, M = Al.; B, D, F, H, L, N = Ch.; J, P = Cu.
28-61	28-21	37		37	45°	A, C, J, Z, m, r, n, a, K, F, H, X, k, h, T, M, N, d = Ir.; Balance = Con.
28-63	28-20	14	10	4	45°	A, C, E, G, J = Al.; B, D, F, H, P = Ch.; Balance = Cu.
28-64	28-15	35		35	None	A, d = Al.; B, j = Ch.; C, D, E, F, G, N, P, R, S, H, J, K, L, M, W, X, Y, Z = Con.; Balance = Cu.
28-65	28-12	26		26	None	A, C, E, G, J, L, N, R, T, V = Ir.; X, Z = Al.; B, D, F, H, K, M, P, S, U, W = Con.; Y, a = Ch.; b, d = Cu.
28-67	28-16	20		20	None	U = Con.; Balance = Cu.
28-68	28-15	35		35	45°	T = Al.; U = Ch.; Balance = Cu.
28-69	28-11	22	4	18	None	G = Al.; R = Ch.; Balance = Cu.
28-70	28-11	22	4	18	None	A = Al.; B = Ch.; Balance = Cu.
28-77	28-11	22	4	18	None	J = Con.; Balance = Cu.
28-81	28-21	37		37	None	A, D, S, Z, n, s = Ir.; B, J, K, f, g, r = Con.; G, L, P, b, e, j = Al.; F, H, T, X, h, k = Ch.; Balance = Cu.
28-85	28-11	22	4	18	45°	K, M = Al.; J, L = Ch.; Bal. = Cu.
28-91	28-9	12	6	6	None	M = Ir.; L = Con.; Bal. = Cu.
28-94	28-12	26		26	None	B, D, F, H, K, M, P, S, U, W, Y, a, d = Al.; Bal. = Ch.
28-98	28-21	37		37	None	M = Al.; F = Ch.; Bal. = Cu.
28-99	28-12	26		26	None	B, D, F, H, K, M, P, S, U, W, Y, a = Con.; Bal. = Cu.
28-AC	28-16	20		20	None	A, C, E, G, J, L = Ir.; B, D, F, N, K, M = Con.; Bal. = Cu.
28-AD	28-21	37		37	45°	A, C, F, H, J, K, M, N, T, X, Z, a, d, h, k, m, n, r = Cu.; Bal. = Cu.
28-AE	28-21	37		37	None	A, C, E, G, J, L, N, R, T, V, X, a, c, e, g, j, m, p, s = Cu.; Bal. = Con.
28-AF	28-18	12		12	None	A, C, E, G, J, L = Ch.; Bal. = Al.
28-AG	28-12	26		26	None	A, C, E, G, J, L, N, R = Al.; B, D, F, H, K, M, P, S = Ch.; Bal. = Cu.
28-AK	28-21	37		37	45°	A, B, C, D, J, K, L, M, N, P, a, b, c, d, e, m, p = Ch.; n = Cu.; Bal. = Al.
32-51	32-8	30	6	24	90°	M = Ch.; N = Al.; Balance = Cu.
32-55	32-8	30	6	24	125°	M, N = Ch.; O, P = Al.; Balance = Cu.
32-91	32-64	54		54	None	A, C, E, G, J, L, N, P, S, U, W, Y, a, c, e, g, j, m = Ir.; B, D, F, H, K, M, O, R, T, V, X, Z, b, d, f, h, k, n = Con.; Bal. = Cu.
36-53	36-7	47	7	40	45°	u, v, w = Al.; x, y, z = Ch.; Balance = Cu.
36-56	36-10	48		48	None	A, C, E, G, L, J, H, P, R, T, V, X, Z, b, d, f, h, k, q, n, m, u, w, y = Con.; Bal. = Cu.
36-57	36-8	47	1	46	None	W = Al.; f = Ch.; Balance = Cu.
36-58	36-15	35		35	None	H = Al.; G = Ch.; Balance = Cu.
36-61	36-15	35		35	None	A, C, E, J, K, L, M, N, P, R, T, V, f, X, Y, h, j, c = Con.; Balance = Cu.
36-62	36-10	48		48	None	A, C, E = Al.; B, D, F = Ch.; Balance = Cu.
36-82	36-52*	52		52	None	v, g = Ir.; p, y, c = Con.; x = Ch.; Balance = Cu.

\* Amphenol arrangement

# QWLD

## thermocouple arrangements

Shell Size and Arrg.	Similar to MS Arrg.	Total Contacts	Contact Size		Pin Insert Rotation CW	Contact Material
			12	16		
36-86	36-10	48		48	None	A, C, E, G, J, L, N, P, R, T, V, X = Al.; B, D, F, H, K, M, O, Q, S, U, W, Y = Ch.; z, b, d, f, h, k, n, q, s, u, w, y = Con.; a, c, e, g, j, m, p, r, t, v, x, z = Cu.
36-88	36-52	52		52	None	A, C, E, H, K, M, P, S, U, W, Y, a, c, f, h, j, m, p, r, t, v, x, z, AB, AD, AF = Cu.; Bal. = Con.
40-58	40-56*	85		85	None	A, C, E, H, K, M, P, S, U, W, Y, a, c, f, h, j, m, p, r, t, v, x, z, AB, AD, AF, AJ, AL, AN, AP, AS, AU, AW, AY, BA, BC, BE, BH, BK, BM, BP, BS, BU = Ir.; Balance = Con.
40-59	40-56*	85		85	None	B = Ch.; C = Con.; Balance = Cu.
40-77	40-53*	60		60	None	55, 60 = Ir.; 57, 58, 59 = Con.; 56 = Ch.; Balance = Cu.
40-78	40-53*	60		60	None	50, 51 = Ir.; 27, 28, 29, 31, 32, 34, 36, 37 = Con.; 25, 39, 40, 41 = Al.; 43, 44, 45, 46, 47, 48, 49, 52, 53, 54 = Ch.; Balance = Cu.
40-88	40-53	60		60	None	1, 3, 5, 7, 9, 11, 13, 15, 17, 19, 21, 23, 25, 27, 29, 31, 33, 35, 37, 39, 41, 43, 45, 47, 49, 51, 53, 55, 57, 59 = Con.; Bal. = Cu.
40-AA	40-56	85		85	None	A, C, E, H, K, M, P, S, U, W, Y, a, c, f, h, j, m, p, r, t, v, x, z, AB, AD, AF, AJ, AL, AN, AR, AT = Cu.; B, D, F, J, L, N, R, T, V, X, Z, b, d, g, i, k, n, q, s, u, w, y, AA, AC, AE, AH, AK, AM, AP, AS = Con.; AU, AW, AY, BA, BC, BE, BH, BK, BM, BP, BS, BU = Cu.; AV, AX, AZ, BB, BD, BF, BJ, BL, BN, BR, BT, BV = Al.
44-57	44-52	104		104	None	A, C, E, G, J, L, etc. = Cu.; B, D, F, H, K, M, etc. = Con.
44-59	44-52	104		104	None	34 = Con.; 70 = Cu.
44-60	44-52	104		104	None	A, C, E, etc. = Ch., (52); B, D, F, etc. = Al., (52)
44-62	44-52	104		104	None	BY, BZ, CA, CB, CC, CD, CE, CR = Al.; CH, CJ, CK, CL, CM, CN, CP, CS = Ch.; Bal. = Cu.

\* Amphenol arrangement

# MIL-C-22992, QWLD MS17343 or 10-1940XX wall mount receptacle

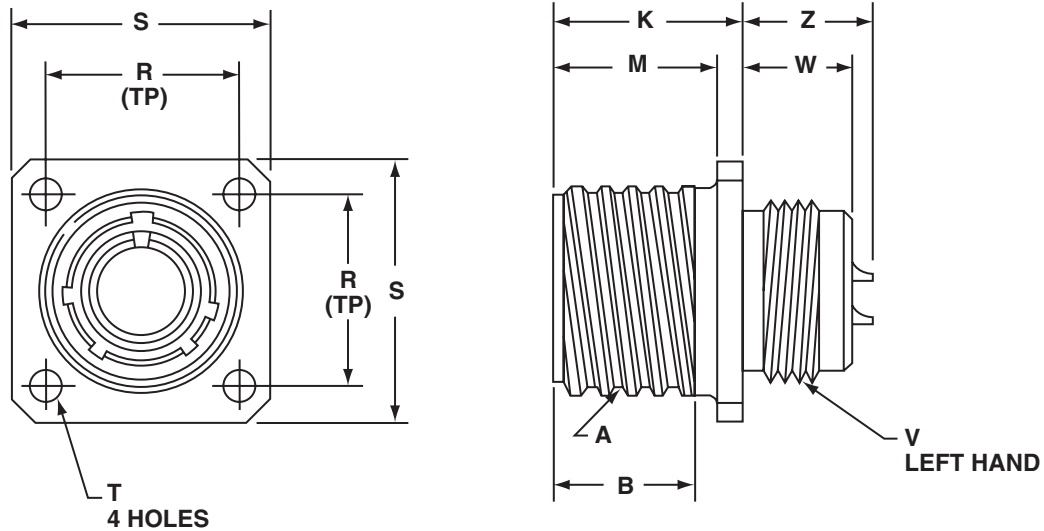

All dimensions for reference only.

Part Number*	Shell Size	A Thread Class 2A (Plated) 0.1P-0.2L Double Stub	B Min Full Thd	K +.021 - .020	M +.010 - .000	R (TP)	S +.021 - .020	T Dia +.004 - .003	V Thread Class 2A-LH (Plated)	W ±.010	Z Max
10-194013	12	.8750	.672	.937	.797	.906	1.188	.150	.750-20UNEF	.640	.700
10-194015	14	1.0000	.672	.937	.797	.969	1.281	.150	.875-20UNEF	.640	.700
10-194017	16	1.1250	.672	.937	.797	1.062	1.375	.150	1.000-20UNEF	.640	.700
10-194018	18	1.2500	.672	.953	.797	1.156	1.500	.177	1.125-18UNEF	.625	.686
10-194020	20	1.3750	.672	.953	.797	1.250	1.625	.177	1.250-18UNEF	.625	.686
10-194022	22	1.5000	.672	.953	.797	1.375	1.750	.177	1.375-18UNEF	.625	.686
10-194024	24	1.7500	.672	1.047	.859	1.562	2.000	.177	1.625-18UNEF	.594	.585
10-194028	28	2.0000	.672	1.047	.859	1.750	2.250	.177	1.875-16UN	.594	.591
10-194032	32	2.2500	.672	1.109	.922	1.938	2.500	.209	2.0625-16UNS	.530	.528
10-194036	36	2.5000	.672	1.109	.922	2.188	2.750	.209	2.3125-16UNS	.530	.528
10-194040	40	2.7500	.672	1.109	.922	2.375	3.000	.209	2.625-16UN	.703	.528
10-194044	44	3.0000	.672	1.109	.922	2.625	3.250	.209	2.875-16UN	.703	.770
10-194048†	48†	3.2500	.672	1.109	.922	2.875	3.500	.209	3.125-16UN	.703	.770

\*To complete 10- part number or to complete MS part number, see how to order, pg. 22.

†Shell size 48 available in proprietary versions only. Consult Sidney, NY for availability and ordering information.

# MIL-C-22992, QWLD MS17345 or 10-1941XX cable connecting plug

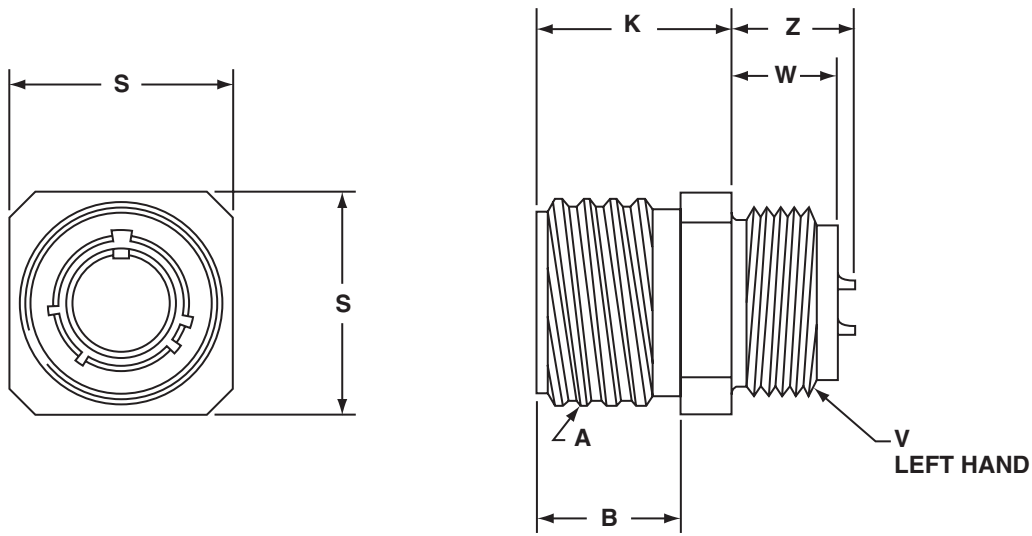

All dimensions for reference only.

Part Number*	Shell Size	A Thread Class 2A (Plated) 0.1P-0.2L Double Stub	B $+.016$ $-.000$	K $+.021$ $-.020$	S $+.021$ $-.020$	V Thread Class 2A-LH (Plated)	W $\pm .010$	Z Max
10-194113	12	.8750	.688	.938	1.000	.750-20UNEF	.641	.696
10-194115	14	1.0000	.688	.938	1.094	.875-20UNEF	.641	.696
10-194117	16	1.1250	.688	.938	1.281	1.000-20UNEF	.641	.696
10-194118	18	1.2500	.703	.957	1.375	1.125-18UNEF	.625	.680
10-194120	20	1.3750	.703	.957	1.500	1.250-18UNEF	.625	.680
10-194122	22	1.5000	.703	.957	1.625	1.375-18UNEF	.625	.680
10-194124	24	1.7500	.766	1.016	1.875	1.625-18UNEF	.625	.617
10-194128	28	2.0000	.766	1.016	2.125	1.875-16UN	.625	.617
10-194132	32	2.2500	.703	1.078	2.375	2.0625-16UN	.563	.555
10-194136	36	2.5000	.703	1.078	2.625	2.3125-16UN	.563	.555
10-194140	40	2.7500	.703	1.078	3.000	2.625-16UN	.703	.555
10-194144	44	3.0000	.703	1.078	3.250	2.875-16UN	.703	.805

\*To complete 10- part number or to complete MS part number, see how to order, pg. 22.



# MIL-C-22992, QWLD MS17346 or 10-1942XX box mount receptacle

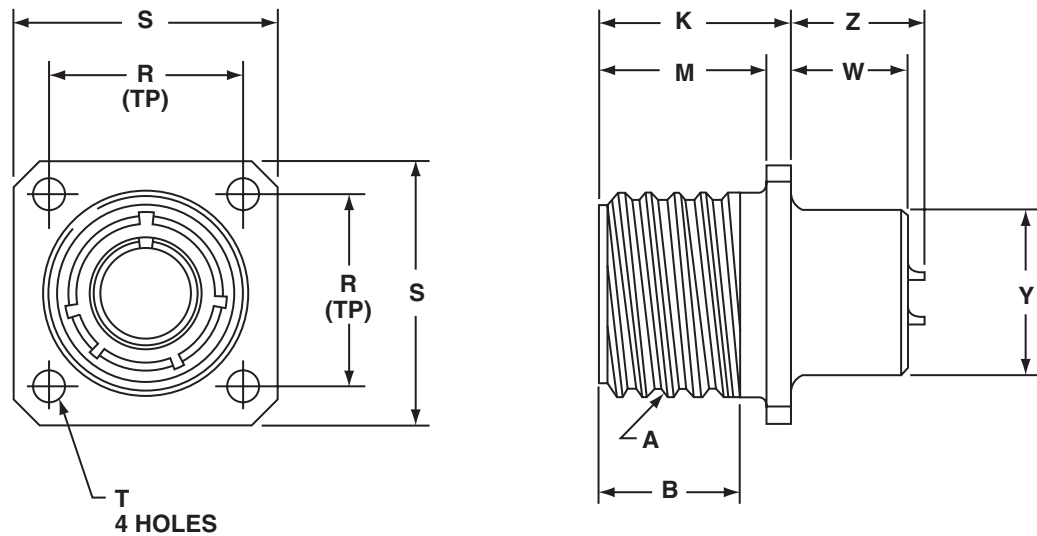

All dimensions for reference only.

Part Number*	Shell Size	A Thread Class 2A (Plated) 0.1P-0.2L Double Stub	B Min Full Thd	K +.021 - .010	M +.010 - .000	R (TP)	S +.021 - .020	T Dia +.004 - .003	W +.020 - .030	Y +.011 - .010	Z Max
10-194213	12	.8750	.672	.938	.797	.906	1.188	.150	.640	.640	.700
10-194215	14	1.0000	.672	.938	.797	.969	1.281	.150	.640	.765	.700
10-194217	16	1.1250	.672	.938	.797	1.062	1.375	.150	.640	.890	.700
10-194218	18	1.2500	.672	.953	.797	1.156	1.500	.177	.625	1.015	.686
10-194220	20	1.3750	.672	.953	.797	1.250	1.625	.177	.625	1.171	.686
10-194222	22	1.5000	.672	.953	.797	1.375	1.750	.177	.625	1.296	.686
10-194224	24	1.7500	.672	1.047	.859	1.562	2.000	.177	.594	1.421	.585
10-194228	28	2.0000	.672	1.047	.859	1.750	2.250	.177	.594	1.625	.591
10-194232	32	2.2500	.672	1.110	.922	1.938	2.500	.209	.531	1.891	.528
10-194236	36	2.5000	.672	1.110	.922	2.188	2.750	.209	.531	2.078	.528
10-194240	40	2.7500	.672	1.110	.922	2.375	3.000	.209	.531	2.312	.528
10-194244	44	3.0000	.672	1.110	.922	2.625	3.250	.209	.531	2.562	.778

\*To complete 10- part number or to complete MS part number, see how to order, pg. 22.

# MIL-C-22992, QWLD MS17347 or 10-1943XX jam nut receptacle (wall mount)

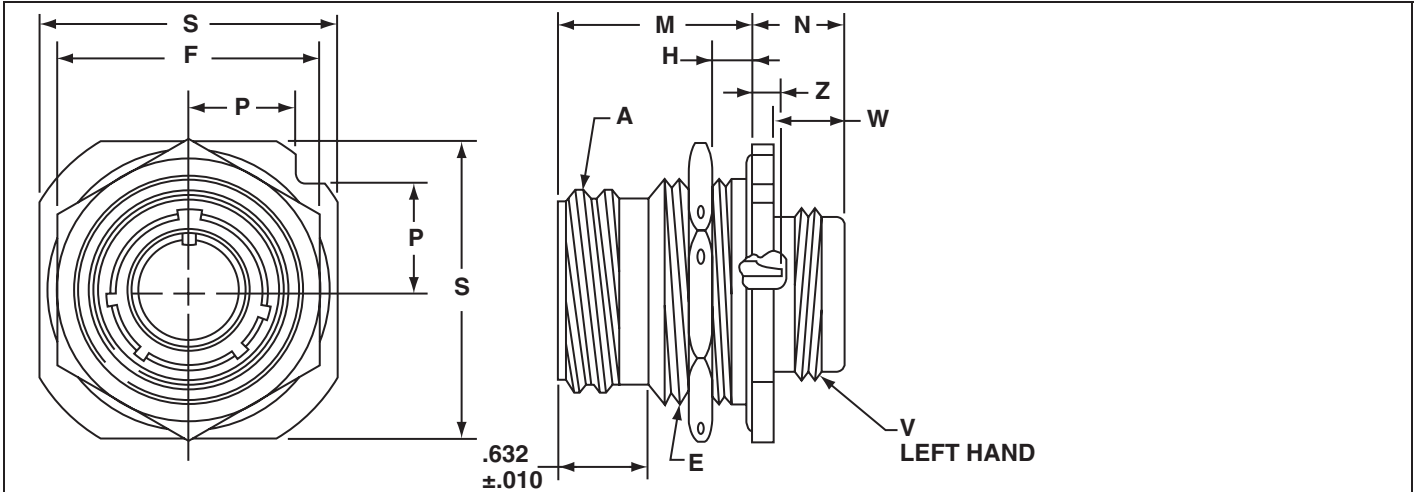

Shell Size	K Dia. +.005 -.000	G ±.003	U ±.005
12,13	1.005	.562	.688
14,15	1.130	.606	.750
16,17	1.255	.699	.875
18	1.380	.739	.938
20	1.505	.783	1.000
22	1.630	.830	1.062
24	1.880	.919	1.188
28	2.130	1.007	1.312
32	2.380	1.096	1.438
36	2.630	1.183	1.562
40	2.880	1.292	1.703

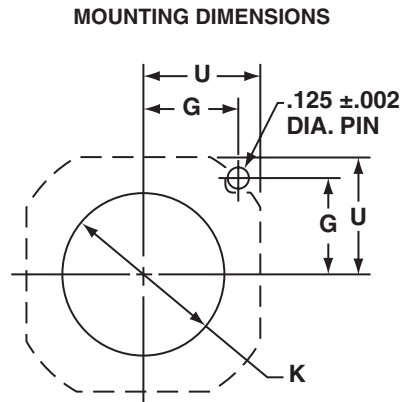

All dimensions for reference only.

Part Number*	Shell Size	A Thread Class 2A (Plated) 0.1P-0.2L Double Stud	E Thread Class 2A (Plated)	F Hex +.017 -.016	H Panel Thickness		M ±.010	N +.021 -.020	P ±.010	S +.011 -.010	V Thread Class 2A-LH (Plated)	W ±.010	Z Max
					Min	Max							
10-194313	12	.8750	1.000-20UNEF	1.250	.094	.188	1.141	.641	.486	1.375	.750-20UNEF	.516	.483
10-194315	14	1.0000	1.125-18UNEF	1.312	.094	.188	1.141	.641	.530	1.500	.875-20UNEF	.516	.483
10-194317	16	1.1250	1.250-18UNEF	1.500	.094	.188	1.141	.703	.623	1.750	1.000-20UNEF	.516	.483
10-194318	18	1.2500	1.375-18UNEF	1.562	.094	.203	1.156	.703	.663	1.875	1.125-18UNEF	.516	.467
10-194320	20	1.3750	1.500-18UNEF	1.750	.094	.203	1.156	.703	.707	2.000	1.250-18UNEF	.516	.467
10-194322	22	1.5000	1.625-18UNEF	1.875	.094	.203	1.156	.703	.751	2.125	1.375-18UNEF	.516	.467
10-194324	24	1.7500	1.875-16UN	2.125	.094	.265	1.219	.703	.840	2.375	1.625-18UNEF	.516	.404
10-194328	28	2.0000	2.125-16UN	2.375	.094	.277	1.231	.785	.928	2.625	1.875-16UN	.516	.392
10-194332	32	2.2500	2.375-16UN	2.625	.094	.215	1.231	.785	1.017	2.875	2.0625-16UN	.516	.392
10-194336	36	2.5000	2.625-16UN	2.875	.094	.215	1.231	.785	1.104	3.125	2.3125-16UN	.516	.392
10-194340	40	2.7500	2.875-16UN	3.125	.094	.215	1.231	.972	1.213	3.406	2.625-16UN	.703	.392
10-194344	44	3.0000	3.125-16UN	3.375	.094	.215	1.231	.972	1.299	3.656	2.875-16UN	.703	.642

\*To complete 10- part number or to complete MS part number, see how to order, pg. 22.

# QWLD 10-1944XX

thru bulkhead receptacle

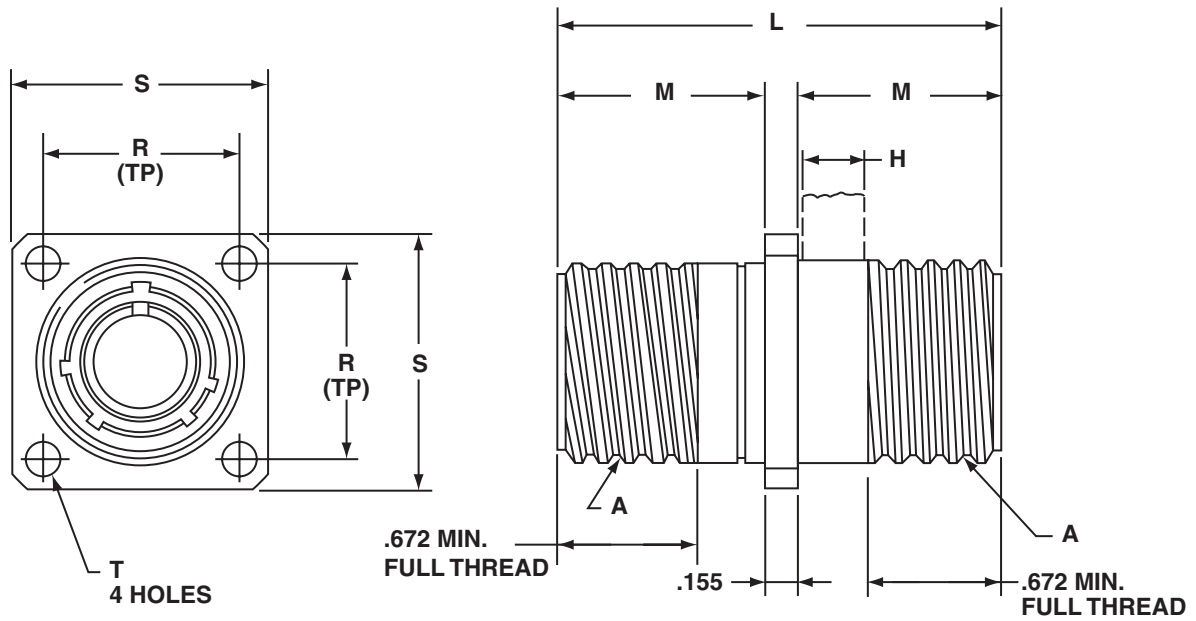

All dimensions for reference only.

Part Number*	Shell Size	A Thread Class 2A (Plated) 0.1P-0.2L Double Stub	H Max	L ±.015	M +.000 - .010	R (TP)	S +.021 - .020	T Dia +.004 - .003
10-194413	12	.8750	.312	2.219	1.032	.906	1.188	.150
10-194415	14	1.0000	.312	2.219	1.032	.969	1.281	.150
10-194417	16	1.1250	.312	2.219	1.032	1.062	1.375	.150
10-194418	18	1.2500	.312	2.219	1.032	1.156	1.500	.177
10-194420	20	1.3750	.312	2.219	1.032	1.250	1.625	.177
10-194422	22	1.5000	.312	2.219	1.032	1.375	1.750	.177
10-194424	24	1.7500	.312	2.219	1.032	1.562	2.000	.177
10-194428	28	2.0000	.312	2.219	1.032	1.750	2.250	.177
10-194432	32	2.2500	.312	2.219	1.032	1.938	2.500	.209
10-194436	36	2.5000	.312	2.219	1.032	2.188	2.750	.209
10-194440	40	2.7500	.312	2.219	1.032	2.375	3.000	.209
10-194444	44	3.0000	.447	2.469	1.157	2.625	3.250	.209
10-194448†	48†	3.2500	.447	2.469	1.157	2.875	3.500	.209

\*To complete 10- part number or to complete MS part number, see how to order, pg. 22.

†Shell size 48 available in proprietary versions only. Consult Sidney, NY for availability and ordering information.

# MIL-C-22992, QWLD MS17344 or 10-1946XX straight plug

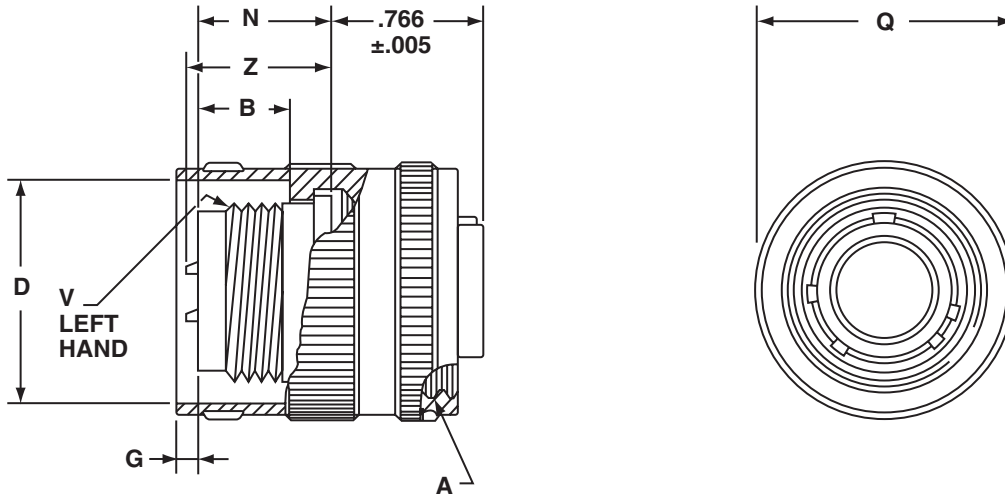

All dimensions for reference only.

Part Number*	Shell Size	A Thread Class 2B 0.1P-0.2L Double Stub	B	D $+0.010$ $-0.001$	G	N $+0.011$ $-0.010$	Q Dia Max	V Thread Class 2A-LH (Plated)	Z Max
10-194613	12	.8750	.519±.020	.985	.030±.030	.738	1.156	.750-20UNEF	.807
10-194615	14	1.0000	.519±.020	1.109	.013±.030	.738	1.281	.875-20UNEF	.807
10-194617	16	1.1250	.519±.020	1.235	.091±.030	.738	1.469	1.000-20UNEF	.807
10-194618	18	1.2500	.519±.020	1.359	.216±.030	.738	1.563	1.125-18UNEF	.807
10-194620	20	1.3750	.519±.020	1.485	.216±.030	.738	1.688	1.250-18UNEF	.807
10-194622	22	1.5000	.519±.020	1.609	.216±.030	.738	1.844	1.375-18UNEF	.807
10-194624	24	1.7500	.519±.020	1.859	.184±.030	.800	2.094	1.625-18UNEF	.807
10-194628	28	2.0000	.519±.020	2.109	.184±.030	.800	2.344	1.875-16UN	.807
10-194632	32	2.2500	.525±.026	2.359	.190±.033	.875	2.594	2.0625-16UNS	.807
10-194636	36	2.5000	.525±.026	2.609	.234±.033	.875	2.844	2.3125-16UNS	.807
10-194640	40	2.7500	.710±.023	2.922	.049±.030	1.041	3.156	2.625-16UN	.807
10-194644	44	3.0000	.710±.023	3.172	.049±.030	1.041	3.406	2.875-16UN	.957

\*To complete 10- part number or to complete MS part number, see how to order, pg. 22.

# MIL-C-22992, QWLD MS17348 or 10-1949XX jam nut receptacle (box mount)

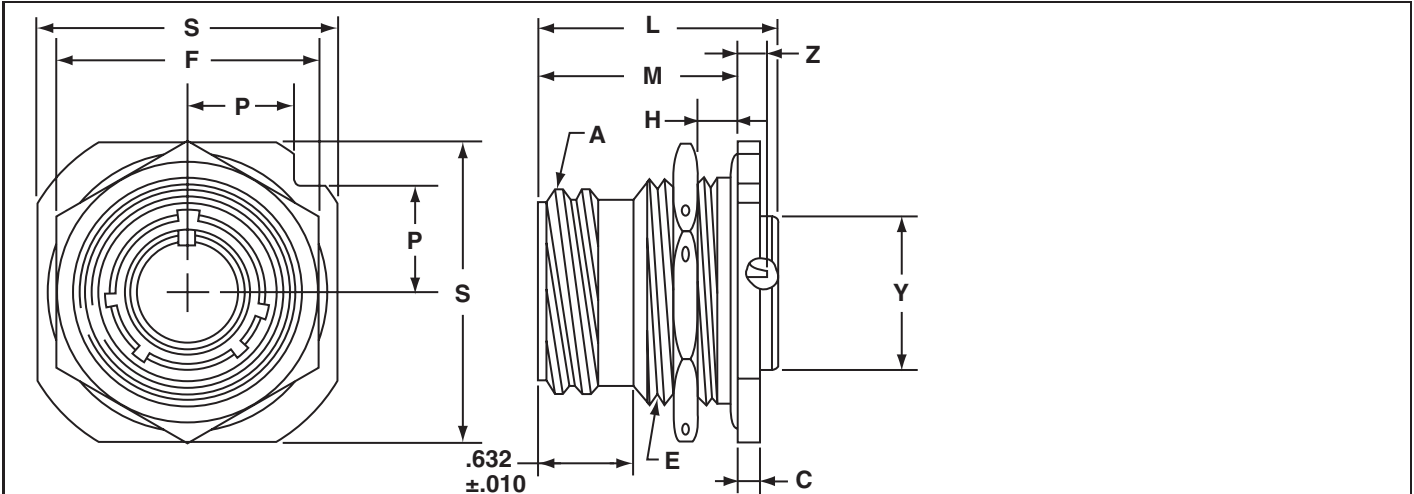

Shell Size	K Dia. +.005 -.000	G ±.003	U ±.005
12,13	1.005	.562	.688
14,15	1.130	.606	.750
16,17	1.255	.699	.875
18	1.380	.739	.938
20	1.505	.783	1.000
22	1.630	.830	1.062
24	1.880	.919	1.188
28	2.130	1.007	1.312
32	2.380	1.096	1.438
36	2.630	1.183	1.562
40	2.880	1.292	1.703

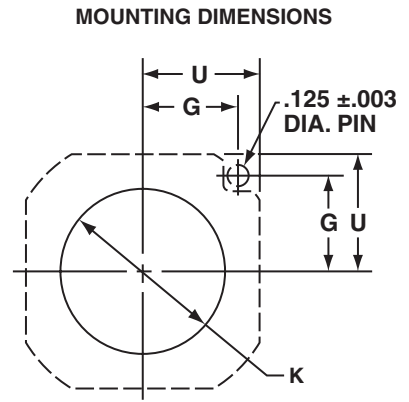

All dimensions for reference only.

Part Number	Shell Size	A Thread Class 2A (Plated) 0.1P-0.2L Double Stub	C +.006 -.005	E Thread Class 2A (Plated)	F Hex +.017 -.016	H Panel Thickness		L +.011 -.010	M ±.010	P ±.010	S +.011 -.010	Y +.011 -.010	Z Max
						Min	Max						
10-194913	12	.8750	.125	1.000-20UNEF	1.250	.094	.297	1.578	1.235	.486	1.375	.640	.389
10-194915	14	1.0000	.125	1.125-18UNEF	1.312	.094	.297	1.578	1.235	.530	1.500	.765	.389
10-194917	16	1.1250	.188	1.250-18UNEF	1.500	.094	.297	1.578	1.235	.623	1.750	.890	.389
10-194918	18	1.2500	.188	1.375-18UNEF	1.562	.094	.266	1.578	1.203	.663	1.875	1.015	.421
10-194920	20	1.3750	.188	1.500-18UNEF	1.750	.094	.266	1.578	1.203	.707	2.000	1.171	.421
10-194922	22	1.5000	.188	1.625-18UNEF	1.875	.094	.266	1.578	1.203	.751	2.125	1.296	.421
10-194924	24	1.7500	.188	1.875-16UN	2.125	.094	.328	1.641	1.266	.840	2.375	1.421	.358
10-194928	28	2.0000	.219	2.125-16UN	2.375	.094	.328	1.641	1.329	.928	2.625	1.625	.295
10-194932	32	2.2500	.219	2.375-16UN	2.625	.094	.328	1.641	1.329	1.017	2.875	1.891	.295
10-194936	36	2.5000	.219	2.625-16UN	2.875	.094	.328	1.641	1.329	1.104	3.125	2.078	.295
10-194940	40	2.7500	.219	2.875-16UN	3.125	.094	.328	1.641	1.329	1.213	3.406	2.312	.295
10-194944	44	3.0000	.219	3.125-16UN	3.375	.094	.328	1.641	1.329	1.299	3.656	2.562	.545

\*To complete 10- part number or to complete MS part number, see how to order, pg. 22.

# MIL-C-22992, QWLD Accessories

## M85049 or 10-522958

cable sealing adapters (plug)

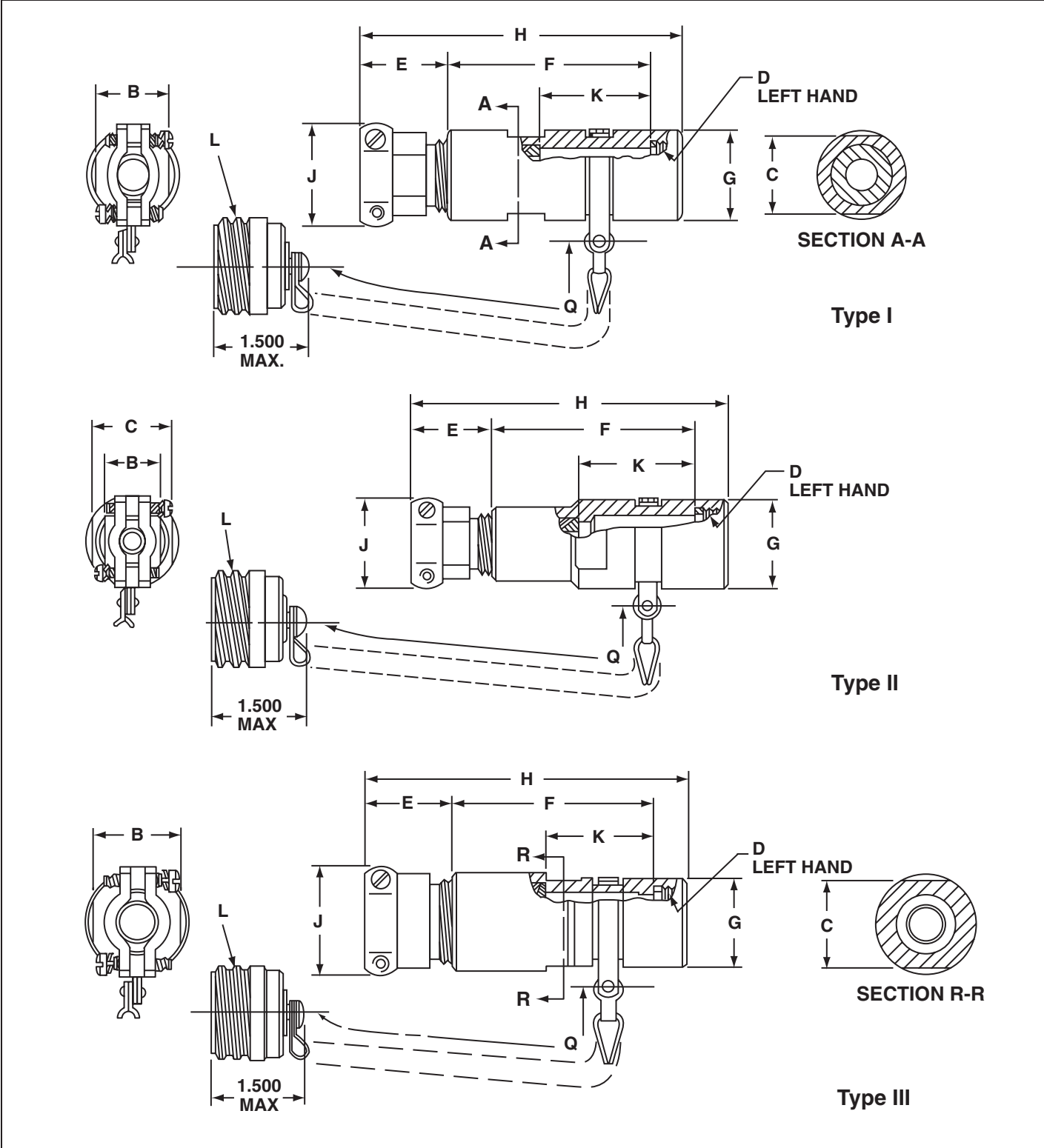

# MIL-C-22992, QWLD Accessories M85049 or 10-522958 cable sealing adapters (plug)

All dimensions for reference only.

MS Part Number*	Superseded MS Part Number	Proprietary Part Number*	Used With Shell Size	Cable Range		B + .000 - .010	C + .000 - .010	D Thread Class 2B-LH	E Free Length Max	F + .010 - .020	G Dia + .010 - .020	H Max	J ± .031	K + .015 - .025	L Thread Class 2A (Plated) 0.1P-0.2L Double Stub	Q Approx.	Type
				Max Dia	Min Dia												
M85049/4A1A1	MS17342N1A1	10-522958-131	12	.530	.436	1.000	.812	.750-20UNEF	1.062	2.719	.938	4.275	1.375	1.219	.8750	5.000	III
M85049/4A2A1	MS17342N2A1	10-522958-132	12	.500	.406	.875	.938	.750-20UNEF	.969	2.215	.938	3.678	1.125	.871	.8750	5.000	III
M85049/4A3A1	MS17342N3A1	10-522958-133	12	.405	.311	1.000	.812	.750-20UNEF	1.062	2.719	.938	4.275	1.375	1.219	.8750	5.000	III
M85049/3A1A1	MS17340N1A1	10-522958-134	12	.375	.281	.750	.812	.750-20UNEF	.969	1.902	.938	3.365	1.062	.621	.8750	5.000	I
M85049/3A2A1	MS17340N2A1	10-522958-135	12	.281	.188	.750	.812	.750-20UNEF	.969	1.902	.938	3.365	1.062	.621	.8750	5.000	I
M85049/5A1A1	MS17341N1A1	10-522958-136	12	.250	.156	.825	.812	.750-20UNEF	.906	1.782	.938	3.182	.938	.563	.8750	5.000	II
M85049/4A5A1	MS17342N5A1	10-522958-151	14	.625	.531	1.062	1.125	.875-20UNEF	1.062	2.933	1.062	4.489	1.562	1.371	1.0000	5.000	III
M85049/4A4A1	MS17342N4A1	10-522958-152	14	.605	.511	1.000	1.062	.875-20UNEF	1.062	2.621	1.062	4.177	1.375	1.121	1.0000	5.000	III
M85049/4A6A1	MS17342N6A1	10-522958-153	14	.530	.436	1.000	1.062	.875-20UNEF	1.062	2.621	1.062	4.177	1.375	1.121	1.0000	5.000	III
M85049/3A3A1	MS17340N3A1	10-522958-154	14	.438	.344	.875	.938	.875-20UNEF	.969	2.215	1.062	3.678	1.125	.871	1.0000	5.000	I
M85049/4A7A1	MS17342N7A1	10-522958-155	14	.405	.311	1.000	1.062	.875-20UNEF	1.062	2.621	1.062	4.177	1.375	1.121	1.0000	5.000	III
M85049/3A4A1	MS17340N4A1	10-522958-171	16	.605	.511	1.000	1.062	1.000-20UNEF	1.062	2.621	1.188	4.177	1.375	1.121	1.1250	5.000	I
M85049/3A5A1	MS17340N5A1	10-522958-172	16	.530	.436	1.000	1.062	1.000-20UNEF	1.062	2.621	1.188	4.177	1.375	1.121	1.1250	5.000	I
M85049/3A6A1	MS17340N6A1	10-522958-173	16	.405	.311	1.000	1.062	1.000-20UNEF	1.062	2.621	1.188	4.177	1.375	1.121	1.1250	5.000	I
M85049/4A8A1	MS17342N8A1	10-522958-181	18	.828	.715	1.188	1.250	1.125-18UNEF	1.094	2.996	1.312	4.584	1.688	1.343	1.2500	5.000	III
M85049/3A8A1	MS17340N8A1	10-522958-182	18	.699	.605	1.062	1.125	1.125-18UNEF	1.062	2.933	1.312	4.489	1.562	1.371	1.2500	5.000	I
M85049/3A7A1	MS17340N7A1	10-522958-183	18	.625	.531	1.062	1.125	1.125-18UNEF	1.062	2.933	1.312	4.489	1.562	1.371	1.2500	5.000	I
M85049/5A5A1	MS17341N5A1	10-522958-184	18	.605	.511	1.000	1.125	1.125-18UNEF	1.062	2.621	1.312	4.177	1.375	1.121	1.2500	5.000	II
M85049/5A6A1	MS17341N6A1	10-522958-185	18	.530	.436	1.000	1.125	1.125-18UNEF	1.062	2.621	1.312	4.177	1.375	1.121	1.2500	5.000	II
M85049/3A9A1	MS17340N9A1	10-522958-186	18	.500	.406	1.062	1.125	1.125-18UNEF	1.062	2.933	1.312	4.489	1.562	1.371	1.2500	5.000	I
M85049/3A10A1	MS17340N10A1	10-522958-187	18	.455	.361	1.062	1.125	1.125-18UNEF	1.062	2.933	1.312	4.489	1.562	1.371	1.2500	5.000	I
M85049/5A2A1	MS17341N2A1	10-522958-188	18	.375	.281	.750	1.125	1.125-18UNEF	.969	2.438	1.312	3.901	1.062	1.157	1.2500	5.000	II
M85049/5A3A1	MS17341N3A1	10-522958-189	18	.375	.281	.875	1.125	1.125-18UNEF	.969	2.469	1.312	3.932	1.125	1.125	1.2500	5.000	II
M85049/5A4A1	MS17341N4A1	10-522958-190	18	.281	.188	.750	1.125	1.125-18UNEF	.969	2.438	1.312	3.901	1.062	1.157	1.2500	5.000	II
M85049/4A12A1	MS17342N12A1	10-522958-201	20	1.055	.930	1.546	1.375	1.250-18UNEF	1.281	3.121	1.438	4.896	2.125	1.371	1.3750	5.000	III
M85049/4A10A1	MS17342N10A1	10-522958-202	20	1.000	.875	1.546	1.375	1.250-18UNEF	1.281	3.121	1.438	4.896	2.125	1.371	1.3750	5.000	III
M85049/4A11A1	MS17342N11A1	10-522958-203	20	.900	.787	1.312	1.375	1.250-18UNEF	1.094	3.059	1.438	4.647	1.812	1.371	1.3750	5.000	III
M85049/3A11A1	MS17340N11A1	10-522958-204	20	.828	.715	1.188	1.250	1.250-18UNEF	1.125	2.996	1.438	4.615	1.688	1.371	1.3750	5.000	I
M85049/4A9A1	MS17342N9A1	10-522958-205	20	.750	.637	1.312	1.375	1.250-18UNEF	1.094	3.059	1.438	4.647	1.812	1.371	1.3750	5.000	III
M85049/5A7A1	MS17341N7A1	10-522958-206	20	.699	.605	1.062	1.250	1.250-18UNEF	1.062	2.933	1.438	4.489	1.562	1.371	1.3750	5.000	II
M85049/5A9A1	MS17341N9A1	10-522958-207	20	.605	.511	1.000	1.250	1.250-18UNEF	1.062	2.750	1.438	4.308	1.375	1.250	1.3750	5.000	II
M85049/3A12A1	MS17340N12A1	10-522958-208	20	.562	.449	1.188	1.250	1.250-18UNEF	1.125	2.996	1.438	4.615	1.688	1.371	1.3750	5.000	I
M85049/5A8A1	MS17341N8A1	10-522958-209	20	.455	.361	1.062	1.250	1.250-18UNEF	1.062	2.933	1.438	4.489	1.562	1.371	1.3750	5.000	II
M85049/4A14A1	MS17342N14A1	10-522958-221	22	1.109	.984	1.546	1.625	1.375-18UNEF	1.281	3.121	1.562	4.896	2.125	1.371	1.5000	6.000	III
M85049/4A13A1	MS17342N13A1	10-522958-222	22	1.000	.875	1.546	1.625	1.375-18UNEF	1.281	3.121	1.562	4.896	2.125	1.371	1.5000	6.000	III
M85049/3A14A1	MS17340N14A1	10-522958-223	22	.900	.787	1.312	1.375	1.375-18UNEF	1.094	3.059	1.562	4.647	1.812	1.371	1.5000	6.000	I
M85049/5A14A1	MS17341N14A1	10-522958-224	22	.828	.715	1.188	1.406	1.375-18UNEF	1.094	2.996	1.562	4.306	1.375	1.250	1.5000	6.000	II
M85049/3A15A1	MS17340N15A1	10-522958-225	22	.805	.692	1.312	1.375	1.375-18UNEF	1.094	3.059	1.562	4.647	1.812	1.371	1.5000	6.000	I
M85049/3A13A1	MS17340N13A1	10-522958-226	22	.750	.637	1.312	1.375	1.375-18UNEF	1.094	3.059	1.562	4.647	1.812	1.371	1.5000	6.000	I
M85049/5A10A1	MS17341N10A1	10-522958-227	22	.562	.449	1.188	1.406	1.375-18UNEF	1.094	3.059	1.562	4.647	1.812	1.371	1.5000	6.000	II
M85049/5A11A1	MS17341N11A1	10-522958-228	22	.405	.311	1.000	1.375	1.375-18UNEF	1.062	2.750	1.562	4.306	1.375	1.250	1.5000	6.000	II

\* Ordering procedure: Locate shell size needed (Column 4); select cable diameter range to be accommodated within the shell size (column 5); order by either MS part number (column 1) or Proprietary part number (column 3).

MS numbers shown are non-conductive finish. To order conductive finish, substitute "W" for "A" in the part number listed.

10- numbers shown are non-conductive finish. To order conductive finish, substitute prefix 88-.

# MIL-C-22992, QWLD Accessories

## M85049 or 10-522958

### cable sealing adapters (plug)

All dimensions for reference only.

MS Part Number*	Superseded MS Part Number	Proprietary Part Number*	Used With Shell Size	Cable Range		B +0.00 -0.10	C +0.00 -0.10	D Thread Class 2B-LH	E Free Length Max	F +0.10 -0.020	G Dia +0.010 -0.020	H Max	J ±.031	K +0.015 -0.025	L Thread Class 2A (Plated) 0.1P-0.2L Double Stub	Q Approx.	Type
				Max Dia	Min Dia												
M85049/4A18A1	MS17342N18A1	10-522958-241	24	1.375	1.250	2.000	1.875	1.625-18UNEF	1.281	3.184	1.812	4.959	2.625	1.309	1.7500	6.000	III
M85049/4A16A1	MS17342N16A1	10-522958-242	24	1.310	1.185	1.780	1.875	1.625-18UNEF	1.281	3.184	1.812	4.959	2.469	1.372	1.7500	6.000	III
M85049/4A17A1	MS17342N17A1	10-522958-243	24	1.230	1.105	1.780	1.875	1.625-18UNEF	1.281	3.184	1.812	4.959	2.469	1.372	1.7500	6.000	III
M85049/4A15A1	MS17342N15A1	10-522958-244	24	1.180	1.055	1.780	1.875	1.625-18UNEF	1.281	3.184	1.812	4.959	2.469	1.372	1.7500	6.000	III
M85049/3A18A1	MS17340N18A1	10-522958-245	24	1.109	.984	1.546	1.625	1.625-18UNEF	1.281	3.121	1.812	4.896	2.125	1.371	1.7500	6.000	I
M85049/3A16A1	MS17340N16A1	10-522958-246	24	1.055	.930	1.546	1.625	1.625-18UNEF	1.281	3.121	1.812	4.896	2.125	1.371	1.7500	6.000	I
M85049/3A17A1	MS17340N17A1	10-522958-247	24	1.000	.675	1.546	1.625	1.625-18UNEF	1.281	3.121	1.812	4.896	2.125	1.371	1.7500	6.000	I
M85049/5A16A1	MS17341N16A1	10-522958-248	24	.970	.857	1.312	1.625	1.625-18UNEF	1.094	3.059	1.812	4.647	1.812	1.371	1.7500	6.000	II
M85049/5A13A1	MS17341N13A1	10-522958-249	24	.900	.787	1.312	1.625	1.625-18UNEF	1.094	3.059	1.812	4.647	1.812	1.371	1.7500	6.000	II
M85049/5A19A1	MS17340N19A1	10-522958-250	24	.880	.755	1.546	1.625	1.625-18UNEF	1.281	3.121	1.812	4.896	2.125	1.371	1.7500	6.000	I
M85049/5A17A1	MS17341N17A1	10-522958-251	24	.828	.715	1.188	1.625	1.625-18UNEF	1.094	2.954	1.812	4.542	1.688	1.301	1.7500	6.000	II
M85049/5A18A1	MS17341N18A1	10-522958-252	24	.805	.692	1.312	1.625	1.625-18UNEF	1.094	3.059	1.812	4.647	1.812	1.371	1.7500	6.000	II
M85049/5A15A1	MS17341N15A1	10-522958-253	24	.750	.637	1.312	1.625	1.625-18UNEF	1.094	3.059	1.812	4.647	1.812	1.371	1.7500	6.000	II
M85049/5A14A1	MS17341N14A1	10-522958-254	24	.630	.517	1.312	1.625	1.625-18UNEF	1.094	3.059	1.812	4.647	1.812	1.371	1.7500	6.000	II
M85049/4A20A1	MS17342N20A1	10-522958-281	28	1.531	1.406	2.000	2.062	1.875-16UN	1.281	3.246	2.062	5.021	2.625	1.371	2.000	6.000	III
M85049/4A19A1	MS17342N19A1	10-522958-282	28	1.445	1.320	2.000	2.062	1.875-16UN	1.281	3.246	2.062	5.021	2.625	1.371	2.000	6.000	III
M85049/4A21A1	MS17342N21A1	10-522958-283	28	1.375	1.250	2.000	2.062	1.875-16UN	1.281	3.246	2.062	5.021	2.625	1.371	2.000	6.000	III
M85049/4A22A1	MS17340N22A1	10-522958-284	28	1.310	1.185	1.780	1.875	1.875-16UN	1.281	3.184	2.062	4.959	2.469	1.372	2.000	6.000	I
M85049/3A21A1	MS17340N21A1	10-522958-285	28	1.230	1.105	1.780	1.875	1.875-16UN	1.281	3.184	2.062	4.959	2.469	1.372	2.000	6.000	I
M85049/3A20A1	MS17340N20A1	10-522958-286	28	1.180	1.055	1.780	1.875	1.875-16UN	1.281	3.184	2.062	4.959	2.469	1.372	2.000	6.000	I
M85049/5A20A1	MS17341N20A1	10-522958-287	28	1.109	.984	1.546	1.875	1.875-16UN	1.281	3.121	2.062	4.896	2.125	1.371	2.000	6.000	II
M85049/5A24A1	MS17341N24A1	10-522958-288	28	1.100	.875	1.546	1.875	1.875-16UN	1.281	3.121	2.062	4.896	2.125	1.371	2.000	6.000	II
M85049/5A23A1	MS17341N23A1	10-522958-289	28	.970	.857	1.312	1.875	1.875-16UN	1.094	3.059	2.062	4.647	1.812	1.371	2.000	6.000	II
M85049/5A19A1	MS17341N19A1	10-522958-290	28	.880	.755	1.546	1.875	1.875-16UN	1.281	3.121	2.062	4.896	2.125	1.371	2.000	6.000	II
M85049/5A21A1	MS17341N21A1	10-522958-291	28	.750	.637	1.312	1.875	1.875-16UN	1.094	3.059	2.062	4.647	1.812	1.371	2.000	6.000	II
M85049/5A26A1	MS17341N26A1	10-522958-292	28	.680	.567	1.312	1.875	1.875-16UN	1.094	3.059	2.062	4.647	1.812	1.371	2.000	6.000	II
M85049/5A25A1	MS17341N25A1	10-522958-293	28	.530	.436	1.000	1.812	1.875-16UN	1.062	2.875	2.062	4.431	1.375	1.375	2.000	6.000	II
M85049/5A22A1	MS17341N22A1	10-522958-294	28	.375	.281	.875	1.875	1.875-16UN	.969	2.766	2.062	4.229	1.125	1.422	2.000	6.000	II
M85049/4A23A1	MS17342N23A1	10-522958-321	32	1.828	1.700	2.438	2.312	2.0625-16UN	1.391	3.500	2.312	5.385	3.171	1.375	2.2500	6.000	III
M85049/4A25A1	MS17342N25A1	10-522958-322	32	1.730	1.605	2.438	2.312	2.0625-16UN	1.391	3.500	2.312	5.385	3.171	1.375	2.2500	6.000	III
M85049/4A22A1	MS17342N22A1	10-522958-323	32	1.656	1.531	2.250	2.312	2.0625-16UN	1.281	3.308	2.312	5.083	2.953	1.370	2.2500	6.000	III
M85049/4A24A1	MS17342N24A1	10-522958-324	32	1.562	1.437	2.250	2.312	2.0625-16UN	1.281	3.308	2.312	5.083	2.953	1.370	2.2500	6.000	III
M85049/3A24A1	MS17340N24A1	10-522958-325	32	1.531	1.406	2.000	2.062	2.0625-16UN	1.281	3.246	2.312	5.021	2.625	1.371	2.2500	6.000	I
M85049/3A23A1	MS17340N23A1	10-522958-326	32	1.445	1.320	2.000	2.062	2.0625-16UN	1.281	3.246	2.312	5.021	2.625	1.371	2.2500	6.000	I
M85049/3A25A1	MS17340N25A1	10-522958-327	32	1.375	1.250	2.000	2.062	2.0625-16UN	1.281	3.246	2.312	5.021	2.625	1.371	2.2500	6.000	I
M85049/5A28A1	MS17341N28A1	10-522958-328	32	1.230	1.150	1.780	2.062	2.0625-16UN	1.281	3.184	2.312	4.959	2.469	1.372	2.2500	6.000	II
M85049/5A35A1	MS17341N35A1	10-522958-329	32	1.130	1.005	1.780	2.062	2.0625-16UN	1.281	3.184	2.312	4.959	2.469	1.372	2.2500	6.000	II
M85049/5A31A1	MS17341N31A1	10-522958-330	32	1.109	.984	1.546	2.062	2.0625-16UN	1.281	3.121	2.312	4.896	2.125	1.371	2.2500	6.000	II
M85049/5A27A1	MS17341N27A1	10-522958-331	32	1.055	.930	1.546	2.062	2.0625-16UN	1.281	3.121	2.312	4.896	2.125	1.371	2.2500	6.000	II
M85049/5A32A1	MS17341N32A1	10-522958-332	32	.970	.857	1.312	2.062	2.0625-16UN	1.094	3.059	2.312	4.647	1.812	1.371	2.2500	6.000	II
M85049/5A30A1	MS17341N30A1	10-522958-333	32	.880	.755	1.546	2.062	2.0625-16UN	1.281	3.121	2.312	4.896	2.125	1.371	2.2500	6.000	II
M85049/5A29A1	MS17341N29A1	10-522958-334	32	.750	.637	1.312	2.062	2.0625-16UN	1.094	3.059	2.312	4.647	1.812	1.371	2.2500	6.000	II

\* Ordering procedure: Locate shell size needed (Column 4); select cable diameter range to be accommodated within the shell size (column 5); order by either MS part number (column 1) or Proprietary part number (column 3).

MS numbers shown are non-conductive finish. To order conductive finish, substitute "W" for "A" in the part number listed.

10- numbers shown are non-conductive finish. To order conductive finish, substitute prefix 88-.



# MIL-C-22992, QWLD Accessories

## M85049 or 10-522958

### cable sealing adapters (plug)

All dimensions for reference only.

MS Part Number*	Superseded MS Part Number	Proprietary Part Number*	Used With Shell Size	Cable Range		B +.000 -.010	C +.000 -.010	D Thread Class 2B-LH	E Free Length Max	F +.010 -.020	G Dia +.010 -.020	H Max	J ±.031	K +.015 -.025	L Thread Class 2A (Plated) 0.1P-0.2L Double Stub	Q Approx.	Type
				Max Dia	Min Dia												
M85049/5A34A1	MS17341N34A1	10-522958-335	32	.530	.436	1.000	2.000	2.0625-16UN	1.062	2.875	2.312	4.431	1.375	1.375	2.2500	6.000	II
M85049/5A33A1	MS17341N33A1	10-522958-336	32	.375	.281	.875	2.062	2.0625-16UN	.969	2.813	2.312	4.276	1.125	1.469	2.2500	6.000	II
M85049/4A30A1	MS17342N30A1	10-522958-361	36	2.062	1.917	2.750	2.500	2.3125-16UN	1.391	3.500	2.562	5.385	3.375	1.375	2.5000	6.000	III
M85049/4A29A1	MS17342N29A1	10-522958-362	36	1.984	1.859	2.438	2.500	2.3125-16UN	1.391	3.469	2.562	5.354	3.171	1.344	2.5000	6.000	III
M85049/4A26A1	MS17342N26A1	10-522958-363	36	1.900	1.775	2.438	2.500	2.3125-16UN	1.391	3.469	2.562	5.354	3.171	1.344	2.5000	6.000	III
M85049/4A28A1	MS17342N28A1	10-522958-364	36	1.825	1.799	2.438	2.500	2.3125-16UN	1.391	3.469	2.562	5.354	3.171	1.344	2.5000	6.000	III
M85049/4A27A1	MS17342N27A1	10-522958-365	36	1.730	1.605	2.438	2.500	2.3125-16UN	1.391	3.469	2.562	5.354	3.171	1.344	2.5000	6.000	III
M85049/3A26A1	MS17340N26A1	10-522958-366	36	1.656	1.531	2.250	2.312	2.3125-16UN	1.281	3.308	2.562	5.083	2.953	1.370	2.5000	6.000	I
M85049/3A27A1	MS17340N27A1	10-522958-367	36	1.562	1.437	2.250	2.312	2.3125-16UN	1.281	3.308	2.562	5.083	2.953	1.370	2.5000	6.000	I
M85049/5A40A1	MS17341N40A1	10-522958-368	36	1.445	1.320	2.000	2.312	2.3125-16UN	1.281	3.246	2.562	5.021	2.625	1.371	2.5000	6.000	II
M85049/5A38A1	MS17341N38A1	10-522958-369	36	1.375	1.250	2.000	2.312	2.3125-16UN	1.281	3.246	2.562	5.021	2.625	1.371	2.5000	6.000	II
M85049/5A36A1	MS17341N36A1	10-522958-370	36	1.310	1.185	1.780	2.312	2.3125-16UN	1.281	3.184	2.562	4.959	2.469	1.372	2.5000	6.000	II
M85049/5A42A1	MS17341N42A1	10-522958-371	36	1.230	1.105	1.780	2.312	2.3125-16UN	1.281	3.184	2.562	4.959	2.469	1.372	2.5000	6.000	II
M85049/5A39A1	MS17341N39A1	10-522958-372	36	1.180	1.055	1.780	2.312	2.3125-16UN	1.281	3.184	2.562	4.959	2.469	1.372	2.5000	6.000	II
M85049/5A37A1	MS17341N37A1	10-522958-373	36	1.109	.984	1.546	2.312	2.3125-16UN	1.281	3.121	2.562	4.896	2.125	1.371	2.5000	6.000	II
M85049/5A41A1	MS17341N41A1	10-522958-374	36	.970	.857	1.312	2.250	2.3125-16UN	1.094	3.063	2.562	4.651	1.812	1.375	2.5000	6.000	II
M85049/4A31A1	MS17342N31A1	10-522958-401	40	2.375	2.230	3.000	2.812	2.625-16UN	1.391	3.609	2.875	5.682	3.625	1.421	2.7500	6.000	III
M85049/4A32A1	MS17342N32A1	10-522958-402	40	2.250	2.105	2.875	2.625	2.625-16UN	1.391	3.609	2.875	5.682	3.500	1.421	2.7500	6.000	III
M85049/4A33A1	MS17342N33A1	10-522958-403	40	2.145	2.000	2.750	2.625	2.625-16UN	1.391	3.547	2.875	5.620	3.375	1.422	2.7500	6.000	III
M85049/4A34A1	MS17342N34A1	10-522958-404	40	2.062	1.917	2.750	2.625	2.625-16UN	1.391	3.547	2.875	5.620	3.375	1.422	2.7500	6.000	III
M85049/5A43A1	MS17341N43A1	10-522958-405	40	1.940	1.815	2.438	2.750	2.625-16UN	1.391	4.281	2.875	6.354	3.171	2.156	2.7500	6.000	II
M85049/5A44A1	MS17341N44A1	10-522958-406	40	1.825	1.700	2.438	2.750	2.625-16UN	1.391	4.281	2.875	6.354	3.171	2.156	2.7500	6.000	II
M85049/5A45A1	MS17341N45A1	10-522958-407	40	1.730	1.605	2.438	2.750	2.625-16UN	1.391	4.281	2.875	6.354	3.171	2.156	2.7500	6.000	II
M85049/5A46A1	MS17341N46A1	10-522958-408	40	1.656	1.531	2.250	2.750	2.625-16UN	1.281	4.094	2.875	6.037	2.953	2.156	2.7500	6.000	II

\* Ordering procedure: Locate shell size needed (Column 4); select cable diameter range to be accommodated within the shell size (column 5); order by either MS part number (column 1) or Proprietary part number (column 3).

MS numbers shown are non-conductive finish. To order conductive finish, substitute "W" for "A" in the part number listed.

10- numbers shown are non-conductive finish. To order conductive finish, substitute prefix 88-.

# MIL-C-22992, QWLD Accessories M85049 or 10-524959 cable sealing adapters (receptacle)

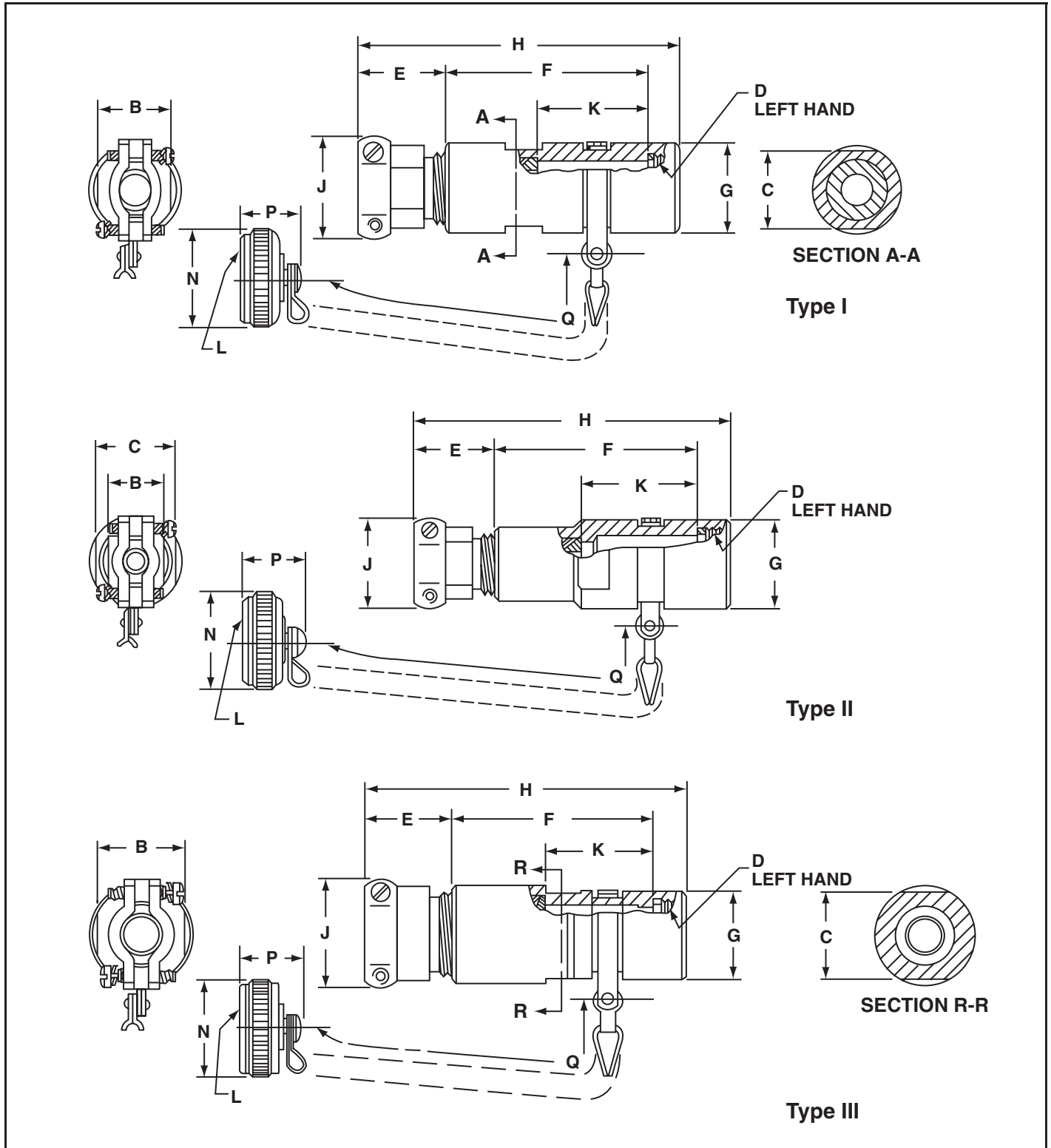

# MIL-C-22992, QWLD Accessories M85049 or 10-524959 cable sealing adapters (receptacle)

All dimensions for reference only.

MS Part Number*	Superseded MS Part Number	Proprietary Part Number*	Used With Shell Size	Cable Range		B +.000 -.010	C +.000 -.010	D Thread Class 2B-LH	E Free Length Max	F +.010 -.020	G Dia +.010 -.020	H Max	J ±.031	K +.015 -.025	L Thread Class 2A 0.1P-0.2L Double Stub	N Dia Maz	P Max	Q Approx.	Type
				Max Dia	Min Dia														
M85049/4A1B1	MS17342N1B1	10-524959-131	12	.530	.436	1.000	.812	.750-20UNEF	1.062	2.719	.938	4.275	1.375	1.219	.8750	2.719	.765	5.000	III
M85049/4A2B1	MS17342N2B1	10-524959-132	12	.500	.406	.875	.938	.750-20UNEF	.969	2.215	.938	3.678	1.125	.871	.8750	2.719	.765	5.000	III
M85049/4A3B1	MS17342N3B1	10-524959-133	12	.405	.311	1.000	.812	.750-20UNEF	1.062	2.719	.938	4.275	1.375	1.219	.8750	1.094	.765	5.000	III
M85049/3A1B1	MS17340N1B1	10-524959-134	12	.375	.281	.750	.812	.750-20UNEF	.969	1.902	.938	3.365	1.062	.621	.8750	1.094	.765	5.000	I
M85049/3A2B1	MS17340N2B1	10-524959-135	12	.281	.188	.750	.812	.750-20UNEF	.969	1.902	.938	3.365	1.062	.621	.8750	1.094	.765	5.000	I
M85049/5A1B1	MS17341N1B1	10-524959-136	12	.250	.156	.625	.812	.750-20UNEF	.906	1.782	.938	3.182	.938	.563	.8750	1.094	.765	5.000	II
M85049/4A5B1	MS17342N5B1	10-524959-151	14	.625	.531	1.062	1.125	.875-20UNEF	1.062	2.933	1.062	4.489	1.562	1.371	1.0000	1.094	.765	5.000	III
M85049/4A4B1	MS17342N4B1	10-524959-152	14	.605	.511	1.000	1.062	.875-20UNEF	1.062	2.621	1.062	4.177	1.375	1.121	1.0000	1.094	.765	5.000	III
M85049/4A6B1	MS17342N6B1	10-524959-153	14	.530	.436	1.000	1.062	.875-20UNEF	1.062	2.621	1.062	4.177	1.375	1.121	1.0000	1.094	.765	5.000	III
M85049/3A3B1	MS17340N3B1	10-524959-154	14	.438	.344	.875	.938	.875-20UNEF	.969	2.215	1.062	3.678	1.125	.871	1.0000	1.219	.765	5.000	I
M85049/4A7B1	MS17342N7B1	10-524959-155	14	.405	.311	1.000	1.062	.875-20UNEF	1.062	2.621	1.188	4.177	1.375	1.121	1.0000	1.344	.765	5.000	III
M85049/3A4B1	MS17340N4B1	10-524959-171	16	.605	.511	1.000	1.062	1.000-20UNEF	1.062	2.621	1.188	4.177	1.375	1.121	1.1250	1.344	.980	5.000	I
M85049/3A5B1	MS17340N5B1	10-524959-172	16	.530	.436	1.000	1.062	1.000-20UNEF	1.062	2.621	1.188	4.177	1.375	1.121	1.1250	1.344	.980	5.000	I
M85049/3A6B1	MS17340N6B1	10-524959-173	16	.405	.311	1.000	1.062	1.000-20UNEF	1.062	2.621	1.312	4.177	1.375	1.121	1.1250	1.344	.980	5.000	I
M85049/4A8B1	MS17342N8B1	10-524959-181	18	.828	.715	1.188	1.250	1.125-18UNEF	1.094	2.996	1.312	4.584	1.688	1.343	1.2500	1.469	.980	5.000	III
M85049/3A8B1	MS17340N8B1	10-524959-182	18	.699	.605	1.062	1.125	1.125-18UNEF	1.062	2.933	1.312	4.489	1.562	1.371	1.2500	1.469	.980	5.000	I
M85049/3A7B1	MS17340N7B1	10-524959-183	18	.625	.531	1.062	1.125	1.125-18UNEF	1.062	2.933	1.312	4.489	1.562	1.371	1.2500	1.469	.980	5.000	I
M85049/5A5B1	MS17341N5B1	10-524959-184	18	.605	.511	1.000	1.125	1.125-18UNEF	1.062	2.621	1.312	4.177	1.375	1.121	1.2500	2.719	.980	5.000	II
M85049/5A6B1	MS17341N6B1	10-524959-185	18	.530	.436	1.000	1.125	1.125-18UNEF	1.062	2.621	1.312	4.177	1.375	1.121	1.2500	2.719	.980	5.000	II
M85049/3A9B1	MS17340N9B1	10-524959-186	18	.500	.406	1.062	1.125	1.125-18UNEF	1.062	2.933	1.312	4.489	1.562	1.371	1.2500	1.469	.980	5.000	I
M85049/3A10B1	MS17340N10B1	10-524959-187	18	.455	.361	1.062	1.125	1.125-18UNEF	1.062	2.933	1.312	4.489	1.562	1.371	1.2500	1.469	.980	5.000	I
M85049/5A2B1	MS17341N2B1	10-524959-188	18	.375	.281	.750	1.125	1.125-18UNEF	.969	2.438	1.312	4.901	1.062	1.157	1.2500	2.719	.980	5.000	II
M85049/5A3B1	MS17341N3B1	10-524959-189	18	.375	.281	.875	1.125	1.125-18UNEF	.969	2.469	1.312	4.932	1.125	1.125	1.2500	2.719	.980	5.000	II
M85049/5A4B1	MS17341N4B1	10-524959-190	18	.281	.188	.750	1.125	1.125-18UNEF	.969	2.438	1.312	4.901	1.062	1.157	1.2500	2.719	.980	5.000	II
M85049/4A12B1	MS17342N12B1	10-524959-201	20	1.055	.930	1.546	1.375	1.250-18UNEF	1.281	3.121	1.438	4.896	2.125	1.371	1.3750	2.719	.980	5.000	III
M85049/4A10B1	MS17342N10B1	10-524959-202	20	1.000	.875	1.546	1.375	1.250-18UNEF	1.281	3.121	1.438	4.896	2.125	1.371	1.3750	2.719	.980	6.000	III
M85049/4A11B1	MS17342N11B1	10-524959-203	20	.900	.787	1.312	1.375	1.250-18UNEF	1.094	3.059	1.438	4.647	1.812	1.371	1.3750	2.719	.980	5.000	III
M85049/3A11B1	MS17340N11B1	10-524959-204	20	.828	.715	1.188	1.250	1.250-18UNEF	1.125	2.996	1.438	4.615	1.688	1.371	1.3750	1.562	.980	5.000	I
M85049/4A9B1	MS17342N9B1	10-524959-205	20	.750	.637	1.312	1.375	1.250-18UNEF	1.094	3.059	1.438	4.647	1.812	1.371	1.3750	2.719	.980	5.000	III
M85049/5A7B1	MS17341N7B1	10-524959-206	20	.699	.605	1.062	1.250	1.250-18UNEF	1.062	2.933	1.438	4.489	1.562	1.250	1.3750	2.719	.980	5.000	II
M85049/5A9B1	MS17341N9B1	10-524959-207	20	.605	.511	1.000	1.250	1.250-18UNEF	1.062	2.750	1.438	4.306	1.375	1.371	1.3750	1.562	.980	5.000	II
M85049/3A12B1	MS17340N12B1	10-524959-208	20	.562	.449	1.188	1.250	1.250-18UNEF	1.125	2.996	1.438	4.615	1.688	1.371	1.3750	1.562	.980	5.000	I
M85049/5A8B1	MS17341N8B1	10-524959-209	20	.455	.361	1.062	1.250	1.250-18UNEF	1.062	2.933	1.438	4.489	1.562	1.371	1.3750	1.562	.980	5.000	II
M85049/4A14B1	MS17342N14B1	10-524959-221	22	1.109	.984	1.546	1.625	1.375-18UNEF	1.281	3.121	1.562	4.896	2.125	1.371	1.5000	1.562	.980	6.000	III
M85049/4A13B1	MS17342N13B1	10-524959-222	22	1.000	.875	1.546	1.625	1.375-18UNEF	1.281	3.121	1.562	4.896	2.125	1.371	1.5000	1.562	.980	6.000	III
M85049/3A14B1	MS17340N14B1	10-524959-223	22	.900	.787	1.312	1.375	1.375-18UNEF	1.094	3.059	1.562	4.647	1.812	1.371	1.5000	1.688	.980	6.000	I
M85049/5A12B1	MS17341N12B1	10-524959-224	22	.828	.715	1.188	1.406	1.375-18UNEF	1.094	2.996	1.562	4.306	1.375	1.250	1.5000	1.688	.980	6.000	II
M85049/3A15B1	MS17340N15B1	10-524959-225	22	.805	.692	1.312	1.375	1.375-18UNEF	1.094	3.059	1.562	4.647	1.812	1.371	1.5000	1.688	.980	6.000	I
M85049/3A13B1	MS17340N13B1	10-524959-226	22	.750	.637	1.312	1.375	1.375-18UNEF	1.094	3.059	1.562	4.647	1.812	1.371	1.5000	1.688	.980	6.000	I
M85049/5A10B1	MS17341N10B1	10-524959-227	22	.562	.449	1.188	1.406	1.375-18UNEF	1.094	2.996	1.562	4.584	1.688	1.343	1.5000	2.719	.980	6.000	II
M85049/5A11B1	MS17341N11B1	10-524959-228	22	.405	.311	1.000	1.375	1.375-18UNEF	1.062	2.750	1.562	4.306	1.375	1.250	1.5000	2.719	.980	6.000	II

\* Ordering procedure: Locate shell size needed (Column 4); select cable diameter range to be accommodated within the shell size (column 5); order by either MS part number (column 1) or Proprietary part number (column 3).

MS numbers shown are non-conductive finish. To order conductive finish, substitute "W" for "A" in the part number listed.

10- numbers shown are non-conductive finish. To order conductive finish, substitute prefix 88-.

# MIL-C-22992, QWLD Accessories M85049 or 10-524959 cable sealing adapters (receptacle)

All dimensions for reference only.

MS Part Number*	Superseded MS Part Number	Proprietary Part Number*	Used With Shell Size	Cable Range		B + .000 - .010	C + .000 - .010	D Thread Class 2B-LH	E Free Length Max	F + .010 - .020	G Dia + .010 - .020	H Max	J ± .031	K + .015 - .025	L Thread Class 2A 0.1P-0.2L Double Stub	N Dia Max	P Max	Q Approx.	Type
				Max Dia	Min Dia														
MS85049/4A18B1	MS17342N18B1	10-524959-241	24	1.375	1.250	2.000	1.875	1.625-18UNEF	1.281	3.184	1.812	4.959	2.625	1.309	1.7500	2.719	.980	6.000	III
MS85049/4A16B1	MS17342N16B1	10-524959-242	24	1.310	1.185	1.780	1.875	1.625-18UNEF	1.281	3.184	1.812	4.959	2.469	1.372	1.7500	2.719	.980	6.000	III
MS85049/4A17B1	MS17342N17B1	10-524959-243	24	1.230	1.105	1.780	1.875	1.625-18UNEF	1.281	3.184	1.812	4.959	2.469	1.372	1.7500	2.719	.980	6.000	III
MS85049/4A15B1	MS17342N15B1	10-524959-244	24	1.180	1.055	1.780	1.875	1.625-18UNEF	1.281	3.184	1.812	4.959	2.469	1.372	1.7500	2.719	.980	6.000	III
MS85049/3A18B1	MS17340N18B1	10-524959-245	24	1.109	.984	1.546	1.625	1.625-18UNEF	1.281	3.121	1.812	4.896	2.125	1.371	1.7500	1.938	.980	6.000	I
MS85049/3A16B1	MS17340N16B1	10-524959-246	24	1.055	.930	1.546	1.625	1.625-18UNEF	1.281	3.121	1.812	4.896	2.125	1.371	1.7500	1.938	.980	6.000	I
MS85049/3A17B1	MS17340N17B1	10-524959-247	24	1.000	.675	1.546	1.625	1.625-18UNEF	1.281	3.121	1.812	4.896	2.125	1.371	1.7500	1.938	.980	6.000	I
MS85049/5A16B1	MS17341N16B1	10-524959-248	24	.970	.857	1.312	1.625	1.625-18UNEF	1.094	3.059	1.812	4.647	1.812	1.371	1.7500	2.719	.980	6.000	II
MS85049/5A13B1	MS17341N13B1	10-524959-249	24	.900	.787	1.312	1.625	1.625-18UNEF	1.094	3.059	1.812	4.647	1.812	1.371	1.7500	2.719	.980	6.000	II
MS85049/3A19B1	MS17340N19B1	10-524959-250	24	.880	.755	1.546	1.625	1.625-18UNEF	1.281	3.121	1.812	4.896	2.125	1.371	1.7500	1.938	.980	6.000	I
MS85049/5A17B1	MS17341N17B1	10-524959-251	24	.828	.715	1.188	1.625	1.625-18UNEF	1.094	2.954	1.812	4.542	1.688	1.301	1.7500	2.719	.980	6.000	II
MS85049/5A18B1	MS17341N18B1	10-524959-252	24	.805	.692	1.312	1.625	1.625-18UNEF	1.094	3.059	1.812	4.647	1.812	1.371	1.7500	2.719	.980	6.000	II
MS85049/5A15B1	MS17341N15B1	10-524959-253	24	.750	.637	1.312	1.625	1.625-18UNEF	1.094	3.059	1.812	4.647	1.812	1.371	1.7500	2.719	.980	6.000	II
MS85049/5A14B1	MS17341N14B1	10-524959-254	24	.630	.517	1.312	1.625	1.625-18UNEF	1.094	3.059	1.812	4.647	1.812	1.371	1.7500	2.719	.980	6.000	II
MS85049/4A20B1	MS17342N20B1	10-524959-281	28	1.531	1.406	2.000	2.062	1.875-16UN	1.281	3.246	2.062	5.021	2.625	1.371	2.0000	2.719	.980	6.000	III
MS85049/4A19B1	MS17342N19B1	10-524959-282	28	1.445	1.320	2.000	2.062	1.875-16UN	1.281	3.246	2.062	5.021	2.625	1.371	2.0000	2.719	.980	6.000	III
MS85049/4A21B1	MS17342N21B1	10-524959-283	28	1.375	1.250	2.000	2.062	1.875-16UN	1.281	3.246	2.062	5.021	2.625	1.371	2.0000	2.719	.980	6.000	III
MS85049/3A22B1	MS17340N22B1	10-524959-284	28	1.310	1.185	1.780	1.875	1.875-16UN	1.281	3.184	2.062	4.959	2.469	1.372	2.0000	2.219	.980	6.000	I
MS85049/3A21B1	MS17340N21B1	10-524959-285	28	1.230	1.105	1.780	1.875	1.875-16UN	1.281	3.184	2.062	4.959	2.469	1.372	2.0000	2.219	.980	6.000	I
MS85049/3A20B1	MS17340N20B1	10-524959-286	28	1.180	1.055	1.780	1.875	1.875-16UN	1.281	3.184	2.062	4.959	2.469	1.372	2.0000	2.219	.980	6.000	I
MS85049/5A20B1	MS17341N20B1	10-524959-287	28	1.109	.984	1.546	1.875	1.875-16UN	1.281	3.121	2.062	4.896	2.125	1.371	2.0000	2.279	.980	6.000	II
MS85049/5A24B1	MS17341N24B1	10-524959-288	28	1.000	.875	1.546	1.875	1.875-16UN	1.281	3.121	2.062	4.896	2.125	1.371	2.0000	2.279	.980	6.000	II
MS85049/5A23B1	MS17341N23B1	10-524959-289	28	.970	.857	1.312	1.875	1.875-16UN	1.094	3.059	2.062	4.647	1.812	1.371	2.0000	2.719	.980	6.000	II
MS85049/5A19B1	MS17341N19B1	10-524959-290	28	.880	.755	1.546	1.875	1.875-16UN	1.281	3.121	2.062	4.896	2.125	1.371	2.0000	2.719	.980	6.000	II
MS85049/5A19B1	MS17341N21B1	10-524959-291	28	.750	.637	1.312	1.875	1.875-16UN	1.094	3.059	2.062	4.647	1.812	1.371	2.0000	2.719	.980	6.000	II
MS85049/5A26B1	MS17341N26B1	10-524959-292	28	.680	.567	1.312	1.875	1.875-16UN	1.094	3.059	2.062	4.647	1.812	1.371	2.0000	2.219	.980	6.000	II
MS85049/5A25B1	MS17341N25B1	10-524959-293	28	.530	.436	1.000	1.812	1.875-16UN	1.062	2.875	2.062	4.431	1.375	1.375	2.0000	2.219	.980	6.000	II
MS85049/5A22B1	MS17341N22B1	10-524959-294	28	.375	.281	.875	1.875	1.875-16UN	.969	2.766	2.062	4.229	1.125	1.422	2.0000	2.219	.980	6.000	II
MS85049/4A23B1	MS17342N23B1	10-524959-321	32	1.828	1.700	2.438	2.312	2.0625-16UN	1.391	3.500	2.312	5.385	3.171	1.375	2.2500	2.469	.980	6.000	III
MS85049/4A25B1	MS17342N25B1	10-524959-322	32	1.730	1.605	2.438	2.312	2.0625-16UN	1.391	3.500	2.312	5.385	3.171	1.375	2.2500	2.469	.980	6.000	III
MS85049/4A22B1	MS17342N22B1	10-524959-323	32	1.656	1.531	2.250	2.312	2.0625-16UN	1.281	3.308	2.312	5.083	2.953	1.370	2.2500	2.469	.980	6.000	III
MS85049/4A24B1	MS17342N24B1	10-524959-324	32	1.562	1.437	2.250	2.312	2.0625-16UN	1.281	3.308	2.312	5.083	2.953	1.370	2.2500	2.469	.980	6.000	III
MS85049/3A24B1	MS17340N24B1	10-524959-325	32	1.531	1.406	2.000	2.062	2.0625-16UN	1.281	3.246	2.312	5.021	2.625	1.371	2.2500	2.469	.980	6.000	I
MS85049/3A23B1	MS17340N23B1	10-524959-326	32	1.445	1.320	2.000	2.062	2.0625-16UN	1.281	3.246	2.312	5.021	2.625	1.371	2.2500	2.469	.980	6.000	I
MS85049/3A25B1	MS17340N25B1	10-524959-327	32	1.375	1.250	2.000	2.062	2.0625-16UN	1.281	3.246	2.312	5.021	2.625	1.371	2.2500	2.469	.980	6.000	I
MS85049/5A28B1	MS17341N28B1	10-524959-328	32	1.230	1.150	1.780	2.062	2.0625-16UN	1.281	3.184	2.312	4.959	2.469	1.372	2.2500	2.469	.980	6.000	II
MS85049/5A35B1	MS17341N35B1	10-524959-329	32	1.130	1.005	1.780	2.062	2.0625-16UN	1.281	3.184	2.312	4.959	2.469	1.372	2.2500	2.469	.980	6.000	II
MS85049/5A31B1	MS17341N31B1	10-524959-330	32	1.109	.984	1.546	2.062	2.0625-16UN	1.281	3.121	2.312	4.896	2.125	1.371	2.2500	2.469	.980	6.000	II
MS85049/5A27B1	MS17341N27B1	10-524959-331	32	1.055	.930	1.546	2.062	2.0625-16UN	1.281	3.121	2.312	4.896	2.125	1.371	2.2500	2.469	.980	6.000	II
MS85049/5A32B1	MS17341N32B1	10-524959-332	32	.970	.858	1.312	2.062	2.0625-16UN	1.094	3.059	2.312	4.647	1.812	1.371	2.2500	2.469	.980	6.000	II
MS85049/5A30B1	MS17341N30B1	10-524959-333	32	.880	.755	1.546	2.062	2.0625-16UN	1.281	3.121	2.312	4.896	2.125	1.371	2.2500	2.469	.980	6.000	II

\* Ordering procedure: Locate shell size needed (Column 4); select cable diameter range to be accommodated within the shell size (column 5); order by either MS part number (column 1) or Proprietary part number (column 3).

MS numbers shown are non-conductive finish. To order conductive finish, substitute "W" for "A" in the part number listed.

10- numbers shown are non-conductive finish. To order conductive finish, substitute prefix 88-.

# MIL-C-22992, QWLD Accessories

## M85049 or 10-524959

### cable sealing adapters (receptacle)

All dimensions for reference only.

MS Part Number*	Superseded MS Part Number	Proprietary Part Number*	Used With Shell Size	Cable Range		B +.000 -.010	C +.000 -.010	D Thread Class 2B-LH	E Free Length Max	F +.010 -.020	G Dia +.010 -.020	H Max	J ±.031	K +.015 -.025	L Thread Class 2A 0.1P-0.2L Double Stub	N Dia Max	P Max	Q Approx.	Type
				Max Dia	Min Dia														
M85049/5A29B1	MS17341N29B1	10-524959-334	32	.750	.637	1.312	2.062	2.0625-16UN	1.094	3.059	2.312	4.647	1.612	1.371	2.2500	2.469	.980	6.000	II
M85049/5A34B1	MS17341N34B1	10-524959-335	32	.530	.436	1.000	2.000	2.0625-16UN	1.062	2.875	2.312	4.431	1.375	1.375	2.2500	2.469	.980	6.000	II
M85049/5A53B1	MS17341N33B1	10-524959-336	32	.375	.281	.875	2.062	2.0625-16UN	.969	2.813	2.312	4.276	1.125	1.469	2.2500	2.469	.980	6.000	II
M85049/4A30A1	MS17342N30B1	10-524959-361	36	2.062	1.917	2.750	2.500	2.3125-16UN	1.391	3.500	2.562	5.385	3.375	1.375	2.5000	2.719	.980	6.000	III
M85049/4A29B1	MS17342N29B1	10-524959-362	36	1.984	1.859	2.438	2.500	2.3125-16UN	1.391	3.469	2.562	5.354	3.171	1.344	2.5000	2.719	.980	6.000	III
M85049/4A26B1	MS17342N26B1	10-524959-363	36	1.900	1.775	2.438	2.500	2.3125-16UN	1.391	3.469	2.562	5.354	3.171	1.344	2.5000	2.719	.980	6.000	III
M85049/4A28B1	MS17342N28B1	10-524959-364	36	1.825	1.700	2.438	2.500	2.3125-16UN	1.391	3.469	2.562	5.354	3.171	1.344	2.5000	2.719	.980	6.000	III
M85049/4A27B1	MS17342N27B1	10-524959-365	36	1.730	1.605	2.438	2.500	2.3125-16UN	1.391	3.469	2.562	5.354	3.171	1.344	2.5000	2.719	.980	6.000	III
M85049/3A26B1	MS17340N26B1	10-524959-366	36	1.656	1.531	2.250	2.312	2.3125-16UN	1.281	3.308	2.562	5.083	2.953	1.370	2.5000	2.719	.980	6.000	I
M85049/3A27B1	MS17340N27B1	10-524959-367	36	1.562	1.437	2.250	2.312	2.3125-16UN	1.281	3.308	2.562	5.083	2.953	1.370	2.5000	2.719	.980	6.000	I
M85049/5A40B1	MS17341N40B1	10-524959-368	36	1.445	1.320	2.000	2.312	2.3125-16UN	1.281	3.246	2.562	5.021	2.625	1.371	2.5000	2.719	.980	6.000	II
M85049/5A38B1	MS17341N38B1	10-524959-369	36	1.375	1.250	2.000	2.312	2.3125-16UN	1.281	3.246	2.562	5.021	2.625	1.371	2.5000	2.719	.980	6.000	II
M85049/5A36B1	MS17341N36B1	10-524959-370	36	1.310	1.185	1.780	2.312	2.3125-16UN	1.281	3.184	2.562	4.959	2.469	1.372	2.5000	2.719	.980	6.000	II
M85049/5A42B1	MS17341N42B1	10-524959-371	36	1.230	1.105	1.780	2.312	2.3125-16UN	1.281	3.184	2.562	4.959	2.469	1.372	2.5000	2.719	.980	6.000	II
M85049/5A39B1	MS17341N39B1	10-524959-372	36	1.180	1.055	1.780	2.312	2.3125-16UN	1.281	3.184	2.562	4.959	2.469	1.372	2.5000	2.719	.980	6.000	II
M85049/5A37B1	MS17341N37B1	10-524959-373	36	1.109	.984	1.546	2.312	2.3125-16UN	1.281	3.121	2.562	4.896	2.125	1.371	2.5000	2.719	.980	6.000	II
M85049/5A41B1	MS17341N41B1	10-524959-374	36	.970	.857	1.312	2.250	2.3125-16UN	1.094	3.063	2.562	4.651	1.812	1.375	2.5000	2.719	.980	6.000	II
M85049/4A31B1	MS17342N31B1	10-524959-401	40	2.375	2.230	3.000	2.812	2.625-16UN	1.391	3.609	2.875	5.682	3.625	1.421	2.7500	2.969	.980	6.000	III
M85049/4A32B1	MS17342N32B1	10-524959-402	40	2.250	2.105	2.875	2.625	2.625-16UN	1.391	3.609	2.875	5.682	3.500	1.421	2.7500	2.969	.980	6.000	III
M85049/4A33B1	MS17342N33B1	10-524959-403	40	2.145	2.000	2.750	2.625	2.625-16UN	1.391	3.547	2.875	5.620	3.375	1.422	2.7500	2.969	.980	6.000	III
M85049/4A34B1	MS17342N34B1	10-524959-404	40	2.062	1.917	2.750	2.625	2.625-16UN	1.391	3.547	2.875	5.620	3.375	1.422	2.7500	2.969	.980	6.000	III
M85049/5A43B1	MS17341N43B1	10-524959-405	40	1.940	1.815	2.438	2.750	2.625-16UN	1.391	4.281	2.875	6.334	3.171	2.156	2.7500	2.969	.980	6.000	II
M85049/5A44B1	MS17341N44B1	10-524959-406	40	1.825	1.700	2.438	2.750	2.625-16UN	1.391	4.281	2.875	6.334	3.171	2.156	2.7500	2.969	.980	6.000	II
M85049/5A45B1	MS17341N45B1	10-524959-407	40	1.730	1.605	2.438	2.750	2.625-16UN	1.391	4.281	2.875	6.334	3.171	2.156	2.7500	2.969	.980	6.000	II
M85049/5A46B1	MS17341N46B1	10-524959-408	40	1.656	1.531	2.250	2.625	2.625-16UN	1.281	4.094	2.875	6.057	2.953	2.156	2.7500	2.969	.980	6.000	II

\* Ordering procedure: Locate shell size needed (Column 4); select cable diameter range to be accommodated within the shell size (column 5); order by either MS part number (column 1) or Proprietary part number (column 3).

MS numbers shown are non-conductive finish. To order conductive finish, substitute "W" for "A" in the part number listed.

10- numbers shown are non-conductive finish. To order conductive finish, substitute prefix 88-.

# MIL-C-22992, QWLD Accessories

**10-350695** adapter,  
**10-350349** cable clamp

**10-350695-XX( )**  
 adapter

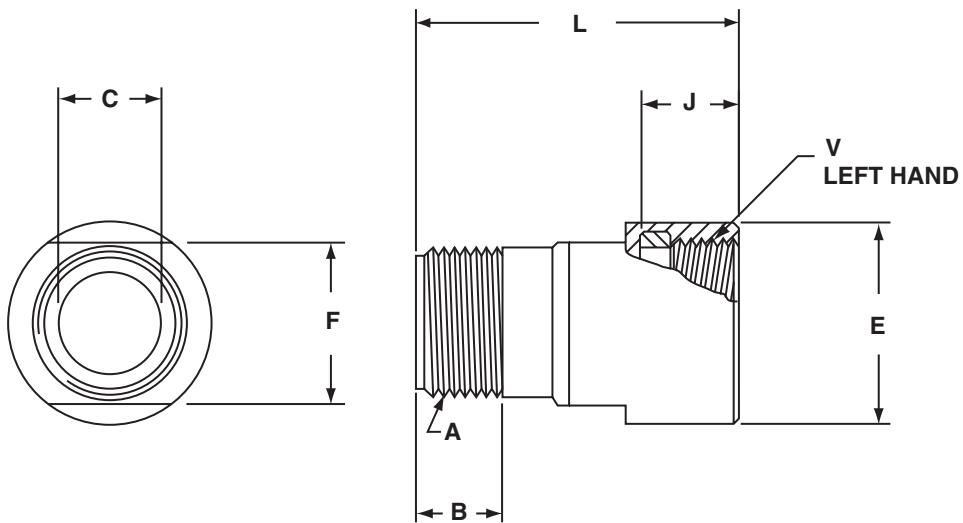

**10-350349-( )3**  
 cable clamp

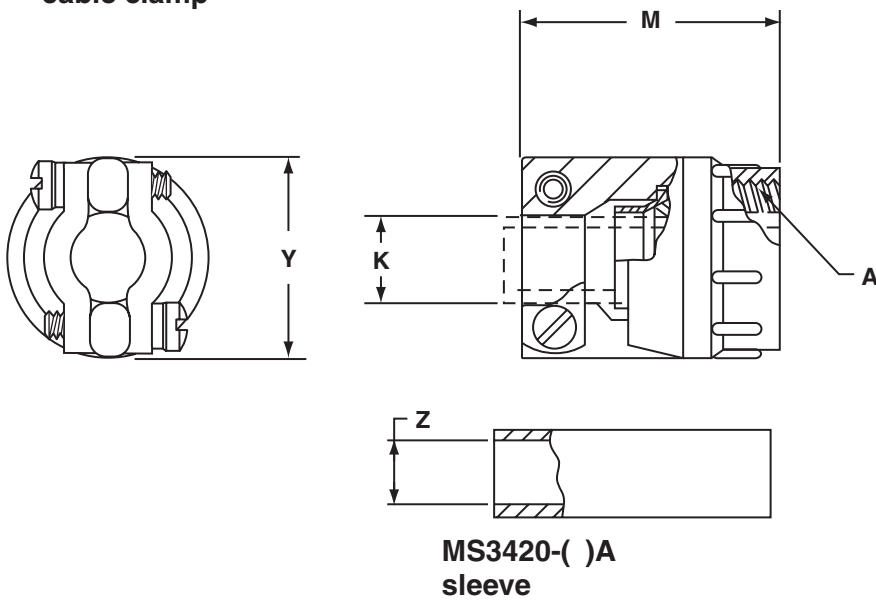

# MIL-C-22992, QWLD Accessories

## 10-350695 adapter,

## 10-350349 cable clamp

All dimensions for reference only.

Shell Size	Proprietary Adapter Part Number*	Clamp Part Number**	Superseded MS Part Number	A Thread Class 2A (Plated)	B Min Full Thd	C Dia +.000 - .010	E +.010 - .020	F ±.010	J +.010 - .000	K Dia		L ±.010	M Max	V Thread Class 2B-LH	Y Max
										Free	Closed				
12	10-350695-13( )	10-350349-12( )	MS3057-4C	.625-24UNEF	.422	.386	.875	.688	.484	.302	.094	1.609	1.375	.750-20UNEF	.906
14	10-350695-15( )	10-350349-14( )	MS3057-6C	.750-20UNEF	.422	.500	1.000	.812	.484	.428	.230	1.609	1.375	.875-20UNEF	1.031
16	10-350695-17( )	10-350349-16( )	MS3057-8C	.875-20UNEF	.422	.625	1.188	.938	.481	.515	.316	1.609	1.375	1.000-20UNEF	1.125
18	10-350695-18( )	10-350349-18( )	MS3057-10C	1.000-20UNEF	.422	.752	1.312	1.062	.481	.614	.378	1.609	1.437	1.125-18UNEF	1.234
20	10-350695-20( )	10-350349-20( )	MS3057-12C	1.1875-18UNEF	.422	.891	1.438	1.250	.481	.738	.445	1.609	1.437	1.250-18UNEF	1.484
22	10-350695-22( )	10-350349-20( )	MS3057-12C	1.1875-18UNEF	.422	.891	1.562	1.250	.481	.738	.445	1.609	1.437	1.375-18UNEF	1.484
24	10-350695-24( )	10-350349-24( )	MS3057-16C	1.4375-18UNEF	.422	1.111	1.812	1.500	.481	.926	.611	1.609	1.562	1.625-18UNEF	1.671
28	10-350695-28( )	10-350349-24( )	MS3057-16C	1.4375-18UNEF	.422	1.111	2.062	1.500	.481	.926	.611	1.781	1.562	1.875-16UN	1.671
32	10-350695-32( )	10-350349-32( )	MS3057-20C	1.750-18UNS	.484	1.422	2.250	1.875	.481	1.200	.922	1.781	1.812	2.0625-16UNS	2.188
36	10-350695-36( )	10-350349-36( )	MS3057-24C	2.000-18UNS	.562	1.672	2.500	2.125	.481	1.363	.922	1.781	2.062	2.3125-16UNS	2.344
40	10-350695-40( )	10-350349-40( )	MS3057-28C	2.250-16UN	.562	1.914	2.812	2.375	.672	1.611	1.180	2.032	2.062	2.625-16UN	2.594

\* To attach the cable clamp to the left hand accessory threads of QWLD connectors, adapter 10-350695-XX is needed. Order this proprietary adapter from column 2 and suffix the part number with the finish desired, listed in the finish chart below.

\*\* Order MS clamp (column 3) to accommodate the cable type being used. Standard finish on the clamp is olive drab, cadmium plate.

Shell Size	Sleeve† MS Part Number	Z Dia	
		Free ±.016	Closed
12	MS3420-4A	.219	.010
14	MS3420-4A	.219	.020
	MS3420-6A	.312	.114
16	MS3420-6A	.312	.085
	MS3420-8A	.438	.222
18	MS3420-6A	.312	.085
	MS3420-10A	.438	.200
20	MS3420-8A	.438	.177
	MS3420-12A	.541	.270
22	MS3420-8A	.438	.177
	MS3420-12A	.541	.270
24	MS3420-8A	.438	.186
	MS3420-12A	.541	.260
	MS3420-16A	.750	.433
28	MS3420-8A	.438	.186
	MS3420-12A	.541	.260
	MS3420-16A	.750	.433
32	MS3420-12A	.541	.273
	MS3420-16A	.750	.442
	MS3420-20A	.938	.620
36	MS3420-16A	.750	.358
	MS3420-18A	.938	.504
	MS3420-24A	1.125	.682
40	MS3420-16A	.750	.368
	MS3420-20A	.938	.514
	MS3420-28A	1.250	.816

†Sleeve not supplied as part of assembly. Order separately by part number shown

Finish Chart for Adapter & Clamp	Suffix
Bright Cadmium Plate	-XX1
Black Anodize	-XX2
Olive Drab, Cadmium Plate	-XX3
Gray Anodize	-XX4
Anodic Coating	-XX*
Olive Drab Cadmium Plate, Nickel Base	-XX9

\* No third digit required for 10-350695 and not available for 10-350349.

# MIL-C-22992, QWLD Accessories

## protective covers

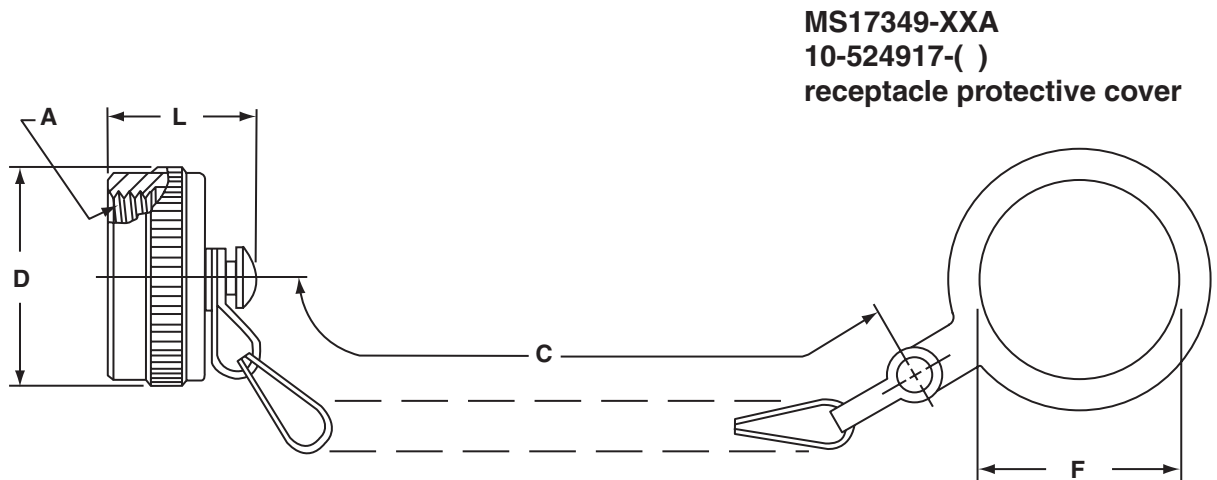
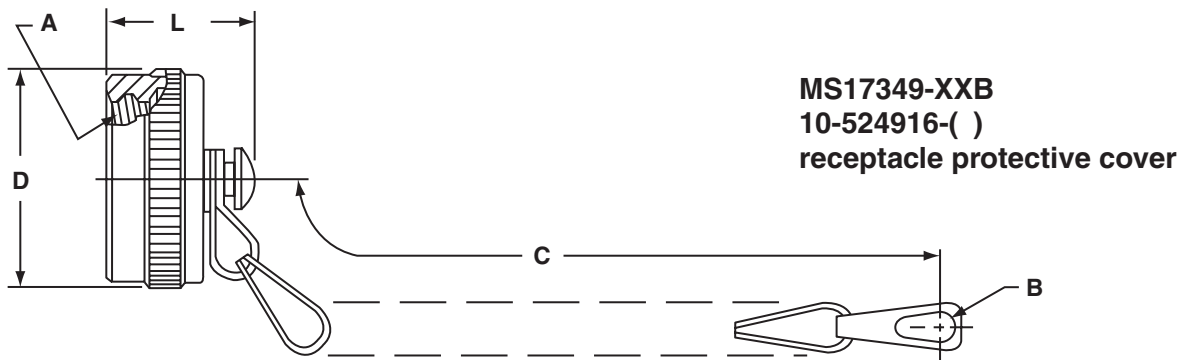
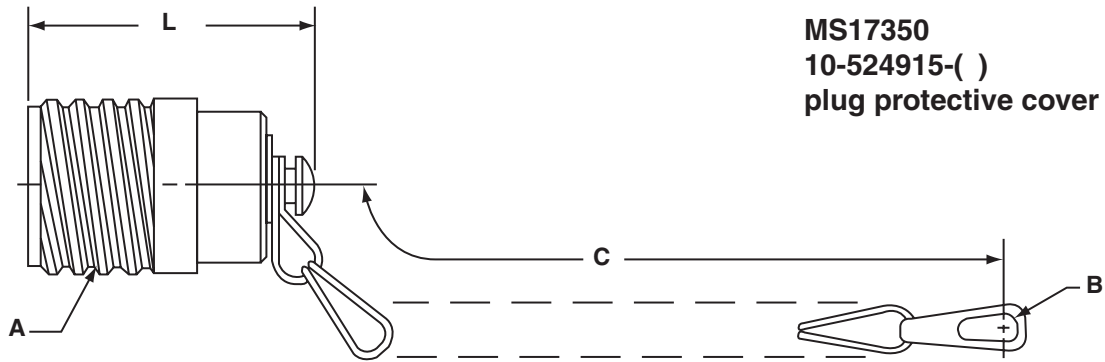



# MIL-C-22992, QWLD Accessories

## protective covers

All dimensions for reference only.

Shell Size	Plug Protective Cover MS Part Number*	Plug Protective Cover Proprietary Part Number**	A Thread Class 2A (Plated) 0.1P-0.2L Double Stub	B Dia +.010 - .005	C Approx.	L Max
12	MS17350-( )	10-524915-12( )	.8750	.156	5.000	1.500
14	MS17350-( )	10-524915-14( )	1.0000	.156	5.000	1.500
16	MS17350-( )	10-524915-16( )	1.1250	.156	5.000	1.500
18	MS17350-( )	10-524915-18( )	1.2500	.180	5.000	1.500
20	MS17350-( )	10-524915-20( )	1.3750	.180	5.000	1.500
22	MS17350-( )	10-524915-22( )	1.5000	.180	6.000	1.500
24	MS17350-( )	10-524915-24( )	1.7500	.180	6.000	1.500
28	MS17350-( )	10-524915-28( )	2.0000	.180	6.000	1.500
32	MS17350-( )	10-524915-32( )	2.2500	.209	6.000	1.500
36	MS17350-( )	10-524915-36( )	2.5000	.209	6.000	1.500
40	MS17350-( )	10-524915-40( )	2.7500	.209	6.000	1.500

\*Order MS-approved covers as per coded part number example:

PART NUMBER			
<u>MS17350</u>	<u>C</u>	<u>28</u>	<u>A</u>
1	2	3	4

- MS Number -**  
MS17350 designated plug protective cover  
MS17349 designated receptacle protect cover
- Cover Finish - C** for conductive, N for non-conductive.
- Cover Size -** Shell size of connector with which cover is used.
- Cover Type - (MS17349 only) -**  
A - Washer Termination, used with:  
MS17345 line (cable connecting) plug  
MS17347 jam nut receptacle  
MS17348 jam nut receptacle  
B - Eyelet Termination - used with:  
MS17343 wall mount receptacle  
MS17346 box mount receptacle

\*\*Order Proprietary covers as per coded part number example:

PART NUMBER			
<u>10-524915</u>	-	<u>28</u>	<u>5</u>
1		2	3

Shell Size	Receptacle Protective Cover MS Part Number*	Receptacle Protective Cover Proprietary Part Number**	A Thread Class 2B 0.1P-0.2L Double Stub	B +.010 - .005	C Approx.	D Dia. Max	F +.010 - .000	L Max
12	MS17349-( )B MS17349-( )A	10-524916-12( ) 10-524917-12( )	.8750	.156	5.000	1.094	1.016	.765
14	MS17349-( )B MS17349-( )A	10-524916-14( ) 10-524917-14( )	1.0000	.156	5.000	1.219	1.141	.765
16	MS17349-( )B MS17349-( )A	10-524916-16( ) 10-524917-16( )	1.1250	.156	5.000	1.344	1.266	.980
18	MS17349-( )B MS17349-( )A	10-524916-18( ) 10-524917-18( )	1.2500	.180	5.000	1.469	1.391	.980
20	MS17349-( )B MS17349-( )A	10-524916-20( ) 10-524917-20( )	1.3750	.180	5.000	1.562	1.516	.980
22	MS17349-( )B MS17349-( )A	10-524916-22( ) 10-524917-22( )	1.5000	.180	6.000	1.688	1.641	.980
24	MS17349-( )B MS17349-( )A	10-524916-24( ) 10-524917-24( )	1.7500	.180	6.000	1.938	1.891	.980
28	MS17349-( )B MS17349-( )A	10-524916-28( ) 10-524917-28( )	2.0000	.180	6.000	2.219	2.141	.980
32	MS17349-( )B MS17349-( )A	10-524916-32( ) 10-524917-32( )	2.2500	.209	6.000	2.469	2.391	.980
36	MS17349-( )B MS17349-( )A	10-524916-36( ) 10-524917-36( )	2.5000	.209	6.000	2.719	2.641	.980
40	MS17349-( )B MS17349-( )A	10-524916-40( ) 10-524917-40( )	2.7500	.209	6.000	2.969	2.891	.980

- Base Number -**  
10-524915 designates plug cover with chain  
10-524916 designates receptacle cover with chain  
10-524917 designates receptacle cover with chain and attaching ring
- Cover Size -** Shell size of connector with which cover is used.
- Finish -**  
5 - Non-conductive Alumilite finish  
9 - Conductive olive drab cadmium plate over nickel finish

**Note:**  
Protective covers are supplied with all M85049 style cable sealing adapters.

# QWLD Accessories

## sealing gaskets

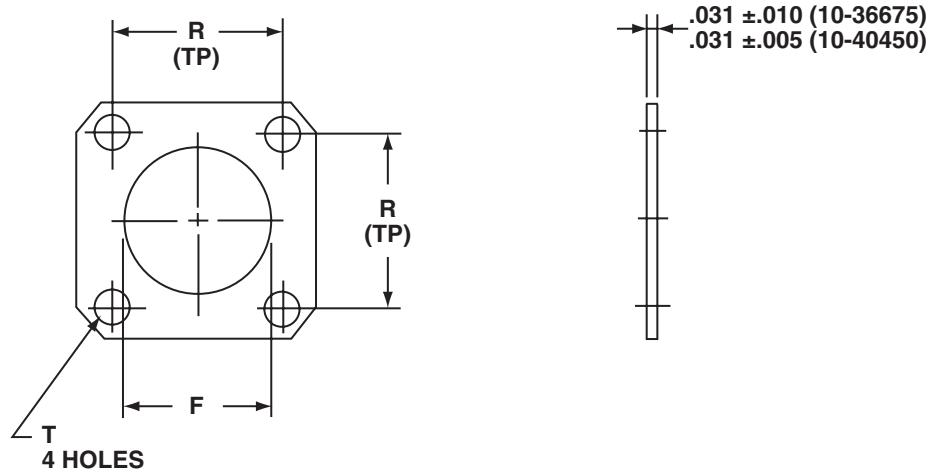

All dimensions for reference only.

Part Number*	Shell Size	F Dia +.016 -.000	R ±.010	T Dia ±.010
10-36675-14	12	.875	.906	.172
10-36675-16	14	1.000	.969	.172
10-36675-18	16	1.125	1.063	.203
10-36675-20	18	1.250	1.156	.203
10-36675-22	20	1.375	1.250	.203
10-36675-24	22	1.500	1.375	.203
10-36675-28	24	1.750	1.563	.203
10-36675-32	28	2.000	1.750	.219
10-36675-36	32	2.188	1.938	.219
10-36675-40	36	2.438	2.188	.219
10-36675-44	40	2.688	2.375	.219
10-36675-48	44	2.938	2.625	.219

\*10-36675-( ) for operating temperature range - 67° to + 275°F.  
Order by part number listed to accommodate shell size being used.

Part Number**	Shell Size	F Dia +.016 -.000	R ±.010	T Dia ±.010
10-40450-14	12	.875	.906	.172
10-40450-16	14	1.000	.969	.172
10-40450-18	16	1.125	1.063	.203
10-40450-20	18	1.250	1.156	.203
10-40450-22	20	1.375	1.250	.203
10-40450-24	22	1.500	1.375	.203
10-40450-28	24	1.750	1.563	.203
10-40450-32	28	2.000	1.750	.219
10-40450-36	32	2.188	1.938	.219
10-40450-40	36	2.437	2.188	.219
10-40450-44	40	2.688	2.375	.219
10-40450-48	44	2.938	2.625	.219

\*\*10-40450-( ) for operating temperature range 0° to + 275°F.  
Order by part number listed to accommodate shell size being used.

# QWLD Accessories

## encapsulation adapter

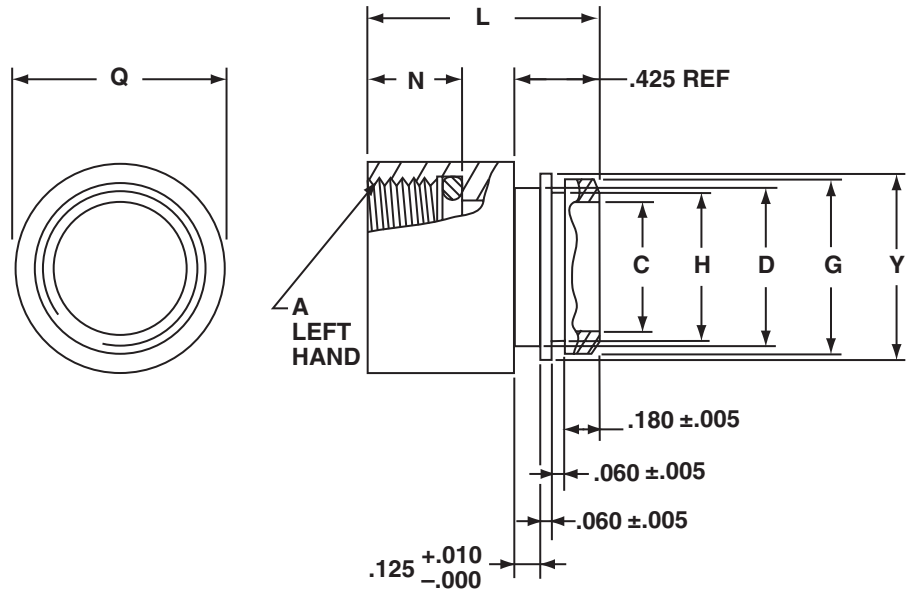

All dimensions for reference only.

Part Number*	Shell Size	A Thread Class 2B-LH	C Dia ±.031	D Dia ±.005	G +.010 / -.000	H Dia ±.005	L ±.031	N ±.016	Q ±.010	Y Dia
10-242067-13( )	12	.750-20UNEF	.500	.673	.766	.673	1.175	.479	.923	.798
10-242067-15( )	14	.875-20UNEF	.656	.797	.844	.797	1.175	.479	1.047	.922
10-242067-17( )	16	1.000-20UNEF	.813	.923	.969	.923	1.175	.479	1.172	1.048
10-242067-18( )	18	1.125-18UNEF	.938	1.047	1.094	1.047	1.175	.479	1.297	1.172
10-242067-20( )	20	1.250-18UNEF	1.063	1.172	1.219	1.172	1.175	.479	1.422	1.297
10-242067-22( )	22	1.375-18UNEF	1.188	1.297	1.344	1.297	1.175	.479	1.547	1.423
10-242067-24( )	24	1.625-18UNEF	1.312	1.537	1.469	1.422	1.175	.479	1.787	1.662
10-242067-28( )	28	1.875-16UN	1.500	1.797	1.719	1.679	1.175	.479	2.047	1.922
10-242067-32( )	32	2.0625-16UN	1.800	2.047	2.000	1.960	1.175	.479	2.297	2.172
10-242067-36( )	36	2.3125-16UN	2.000	2.297	2.219	2.179	1.175	.479	2.547	2.422
10-242067-40( )	40	2.625-16UN	2.250	2.609	2.469	2.429	1.375	.667	2.859	2.734
10-242067-44( )	44	2.875-16UN	2.459	2.857	2.782	2.742	1.375	.667	3.110	2.982
10-242067-48( )	48	3.125-16UN	2.719	3.107	3.046	3.004	1.375	.667	3.360	3.244

\*Order by part number listed to accommodate shell size being used. To complete part number add suffix for finish desired from table below.

Finish	Suffix
Bright Cadmium Plate	-XX1
Black Anodize	-XX2
Cadmium Plate, Olive Drab	-XX3
Gray Anodize	-XX4
Anodic Coating	-XX5
Cadmium Plate Nickel Base	-XX7

# QWLD Accessories

## encapsulation end bell

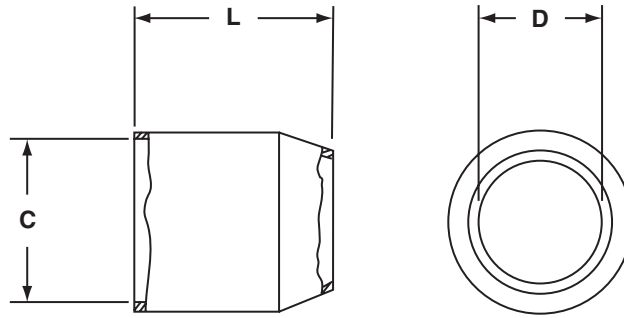

All dimensions are for reference only.

Part Number*	C Dia	D Dia ±.010	L ±.010
10-130999-13	.766 <sup>+0.000</sup> / <sub>-.010</sub>	.484	1.273
10-130999-15	.844 <sup>+0.000</sup> / <sub>-.010</sub>	.609	1.273
10-130999-17	.969 <sup>+0.000</sup> / <sub>-.010</sub>	.734	1.273
10-130999-18	1.094 <sup>+0.000</sup> / <sub>-.010</sub>	.859	1.242
10-130999-20	1.219 <sup>+0.000</sup> / <sub>-.015</sub>	.984	1.242
10-130999-22	1.344 <sup>+0.000</sup> / <sub>-.015</sub>	1.109	1.242
10-130999-24	1.469 <sup>+0.000</sup> / <sub>-.015</sub>	1.234	1.179
10-130999-28	1.719 <sup>+0.000</sup> / <sub>-.015</sub>	1.427	1.179
10-130999-32	2.000 <sup>+0.000</sup> / <sub>-.020</sub>	1.708	1.101
10-130999-36	2.219 <sup>+0.000</sup> / <sub>-.020</sub>	1.895	1.101
10-130999-40	2.469 <sup>+0.000</sup> / <sub>-.020</sub>	2.130	1.101
10-130999-44	2.782 <sup>+0.000</sup> / <sub>-.020</sub>	2.443	1.101
10-130999-48	3.046 <sup>+0.000</sup> / <sub>-.020</sub>	2.707	1.101

\*Order by part number listed to accommodate shell size being used.

# MIL-C-22992, QWLD

## MS solder contacts

Machine copper alloy contacts in a full range of sizes, with closed entry socket design in the size 12 and 16 contacts. A heavy silver-plated finish is deposited on all MS style solder contacts for maximum corrosion resistance, maximum current carrying capacity and low millivolt drop. Gold plated contacts are also available (See how to order, page 22).

### SOLDER CONTACTS\*

Part Number	Pin/Socket	Mating End Size	Wire Barrel Size	Allowable Wire Size	Test Current** Amps
10-36982-3 10-36983-3	Pin Socket	16 Long	16	16 18 20 22	13 10 7.5 5
10-36982-5 10-36983-5	Pin Socket	12	12	12 10	23 17
10-407028-8 10-407029-8	Pin Socket	8	8	8 10	46 33
10-407028-4 10-407029-4	Pin Socket	4	4	4 6	80 60
10-407028-3 10-407029-3	Pin Socket	0	0	0 1 2	150 125 100

\* Solder Wells Unfilled

\*\* Contact ratings as stated are test ratings only. The connector could not withstand full rated current through all contacts continuously. Please note that the electrical data given is not an establishment of electrical safety factors. This is left entirely in the designer's hands as he can best determine which peak voltage, switching surges, transients, etc. can be expected in a particular circuit.

**Table I**  
**CONTACT ARRANGEMENT**  
**SERVICE RATING**

MS Service Rating	Recommended Operating Voltage* at Sea Level		Effective Creepage Distance Nom.	Mechanical Spacing Nom.
	DC	AC(RMS)		
Inst.	250	200	1/16	
A	700	500	1/8	1/16
D	1250	900	3/16	1/8
E	1750	1250	1/4	3/16
B	2450	1750	5/16	1/4
C	4200	3000	1	5/16

\* The values listed in Table I represent operating values which include a generous safety factor. It may be necessary for some applications to exceed the operating voltages listed here. If this is necessary, designers will find Table II useful for determining the degree to which the recommended values of Table I can be exceeded.

**Table II**  
**ALTITUDE VOLTAGE**  
**DERATING\*\* CHART**

MS Service Rating	Nominal Distance		Standard Sea Level Conditions		Pressure Altitude† 50,000 Feet		Pressure Altitude† 70,000 Feet	
	Airspace	Creepage	Minimum Flashover Voltage AC(RMS)	Test Voltage AC(RMS)	Minimum Flashover Voltage AC(RMS)	Test Voltage AC(RMS)	Minimum Flashover Voltage AC(RMS)	Test Voltage AC(RMS)
Inst.	1/32	1/16	1400	1000	550	400	325	260
A	1/16	1/8	2800	2000	800	600	450	360
D	1/8	3/16	3600	2800	900	675	500	400
E	3/16	1/4	4500	3500	1000	750	550	440
B	1/4	5/16	5700	4500	1100	825	600	480
C	5/16	1	8500	7000	1300	975	700	560

† Not corrected for changes in density due to variations in temperature.

\*\* No attempt has been made to recommend operating voltages. The designer must determine his own operating voltage by the application of a safety factor to the above derating chart to compensate for circuit transients, surges, etc.

# QWLD

## solderless (crimp) contacts

Machined from copper alloys and silver-plated for maximum corrosion resistance, with a minimum millivolt drop and a maximum current carrying capacity, the size 16 and 12 socket contacts are of the closed entry design. Crimp contacts are available for all MS insert arrangements and are identified with an Amphenol® proprietary number. Gold plated contacts are also available (See how to order, page 22).

### CRIMP CONTACTS\*

Part Number	Pin/Socket	Mating End Size	Wire Barrel Size	Allowable Wire Size	Required Wire Adapter Sleeve	Test Current** Amps
10-40557	Pin	16 Long	16	16	—	13
10-40556 or 10-597109-171	Socket			18	—	10
				20	—	7.5
				22*	10-74696-6	5
10-40561	Pin	12	12	12	—	23
10-40560 or 10-597109-131	Socket			14	—	17
10-40792	Pin	8	8	8	—	46
10-40793	Socket			10*	10-74696-1	33
10-40564	Pin	4	4	4	—	80
10-40565	Socket			6*	10-74696-2	60
10-40562	Pin	0	0	0	—	150
10-40563	Socket			2*	10-74696-7	100

\* When using wire adapter sleeve shown.

\*\* Contact ratings as stated are test ratings only. The connector could not withstand full rated current through all contacts continuously. Please note that the electrical data given is not an establishment of electrical safety factors. This is left entirely in the designer's hands as he can best determine which peak voltage, switching surges, transients, etc. can be expected in a particular circuit.

**Table I**  
**CONTACT ARRANGEMENT**  
**SERVICE RATING**

MS Service Rating	Recommended Operating Voltage* at Sea Level		Effective Creepage Distance Nom.	Mechanical Spacing Nom.
	DC	AC (RMS)		
Inst.	250	200	1/16	
A	700	500	1/8	1/16
D	1250	900	3/16	1/8
E	1750	1250	1/4	3/16
B	2450	1750	5/16	1/4
C	4200	3000	1	5/16

\* The values listed in Table I represent operating values which include a generous safety factor. It may be necessary for some applications to exceed the operating voltages listed here. If this is necessary, designers will find Table II useful for determining the degree to which the recommended values of Table I can be exceeded.

**Table II**  
**ALTITUDE VOLTAGE**  
**DERATING\*\***

MS Service Rating	Nominal Distance		Standard Sea Level Conditions		Pressure Altitude† 50,000 feet		Pressure Altitude† 70,000 feet	
	Airspace	Creepage	Minimum Flashover Voltage AC (RMS)	Test Voltage AC (RMS)	Minimum Flashover Voltage AC (RMS)	Test Voltage AC (RMS)	Minimum Flashover Voltage AC (RMS)	Test Voltage AC (RMS)
Inst.	1/32	1/16	1400	1000	550	400	325	260
A	1/16	1/8	2800	2000	800	600	450	360
D	1/8	3/16	3600	2800	900	675	500	400
E	3/16	1/4	4500	3500	1000	750	550	440
B	1/4	5/16	5700	4500	1100	825	600	480
C	5/16	1	8500	7000	1300	975	700	560

† Not corrected for changes in density due to variations in temperature.

\*\* No attempt has been made to recommend operating voltages. The designer must determine his own operating voltage by the application of a safety factor to the above derating chart to compensate for circuit transients, surges, etc.

# QWLD

## application tools

Complete installation instructions (L-615) for Amphenol® QWLD Series Connectors are available on request.

The following data includes information pertaining to the application tools which have been established for crimping, inserting and removing crimp contacts used in QWLD Series Connectors.

### Contact Crimping, Insertion & Removal Tools

Crimping Tool	Positioner/ Turret	Contact Size	Contact Style	Insertion Tool	Removal Tool
M22520/1-01	*	16	Pin & Socket	11-7345	11-8250 Kit
M22520/1-01	*	12	Pin & Socket	11-7082	11-8250 Kit
**	**	8	Pin & Socket	11-8220	11-8250 Kit
**	**	4	Pin & Socket	11-7365-4†	Pin 11-7370-4† Socket 11-7674-2†
**	**	0	Pin & Socket	11-7365-5†	Pin 11-7370-5† Socket 11-7674-3†

\* Use Daniels Turret TH29-1 or Astro Tool Co. Turret 616266

\*\* For appropriate crimp tool and positioner refer to Pico Crimping Tool Co.

† Tool used with Arbor press 11-7364.

# Amphenol® Heavy Duty Cylindrical Connectors

## QWL Series



wall mount receptacle



thru bulkhead receptacle



cable connecting plug



straight plug



box mount receptacle

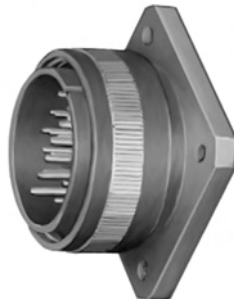

flange mount plug



jam nut receptacle  
(wall mount)



jam nut receptacle  
(box mount)

**Amphenol® QWL Series Connectors are tailor made for compact, heavy duty industrial use.**

The outstanding performance of this series makes it well suited for ship-board installations and ground support power distribution applications where physical strength and dependability are key requirements.

**The QWL Series are a versatile, economical alternative to military qualified designs.**

Equivalent MS shell sizes and insert arrangements offer compatibility with all standard cable types. MIL-C-22992 environmental connector requirements (see page 1) are used as a performance criteria base for this series to assure reliability under the most severe conditions.

**The design features of this connector series provide:**

- **Exceptional Service** - high strength aluminum shells with Alu-milite 225\* hard anodic finish and shock resistant resilient inserts.
- **Foolproof Operation** - rugged double stub coupling threads, left hand accessory threads and simple single keyway mating.
- **Versatility** - both MS and custom insert patterns available for a wide variety of multiconductor cables.

A complete line of accessories is available for use with QWL Series connectors, including cable sealing and clamp adapters, protective covers, flange gaskets and banding clamps.

For further information concerning Amphenol® QWL Series connectors, request catalog 12-053 or contact your local sales office.

\* Registered trademark of Aluminum Company of America



Компания «Океан Электроники» предлагает заключение долгосрочных отношений при поставках импортных электронных компонентов на взаимовыгодных условиях!

Наши преимущества:

- Поставка оригинальных импортных электронных компонентов напрямую с производств Америки, Европы и Азии, а так же с крупнейших складов мира;
- Широкая линейка поставок активных и пассивных импортных электронных компонентов (более 30 млн. наименований);
- Поставка сложных, дефицитных, либо снятых с производства позиций;
- Оперативные сроки поставки под заказ (от 5 рабочих дней);
- Экспресс доставка в любую точку России;
- Помощь Конструкторского Отдела и консультации квалифицированных инженеров;
- Техническая поддержка проекта, помощь в подборе аналогов, поставка прототипов;
- Поставка электронных компонентов под контролем ВП;
- Система менеджмента качества сертифицирована по Международному стандарту ISO 9001;
- При необходимости вся продукция военного и аэрокосмического назначения проходит испытания и сертификацию в лаборатории (по согласованию с заказчиком);
- Поставка специализированных компонентов военного и аэрокосмического уровня качества (Xilinx, Altera, Analog Devices, Intersil, Interpoint, Microsemi, Actel, Aeroflex, Peregrine, VPT, Syfer, Eurofarad, Texas Instruments, MS Kennedy, Miteq, Cobham, E2V, MA-COM, Hittite, Mini-Circuits, General Dynamics и др.);

Компания «Океан Электроники» является официальным дистрибьютором и эксклюзивным представителем в России одного из крупнейших производителей разъемов военного и аэрокосмического назначения «**JONHON**», а так же официальным дистрибьютором и эксклюзивным представителем в России производителя высокотехнологичных и надежных решений для передачи СВЧ сигналов «**FORSTAR**».



## JONHON

«**JONHON**» (основан в 1970 г.)

Разъемы специального, военного и аэрокосмического назначения:

(Применяются в военной, авиационной, аэрокосмической, морской, железнодорожной, горно- и нефтедобывающей отраслях промышленности)

«**FORSTAR**» (основан в 1998 г.)

ВЧ соединители, коаксиальные кабели,  
кабельные сборки и микроволновые компоненты:

(Применяются в телекоммуникациях гражданского и специального назначения, в средствах связи, РЛС, а так же военной, авиационной и аэрокосмической отраслях промышленности).



Телефон: 8 (812) 309-75-97 (многоканальный)

Факс: 8 (812) 320-03-32

Электронная почта: [ocean@oceanchips.ru](mailto:ocean@oceanchips.ru)

Web: <http://oceanchips.ru/>

Адрес: 198099, г. Санкт-Петербург, ул. Калинина, д. 2, корп. 4, лит. А