

1/32 DIN Digital Panel Meter K3GN

CSM_K3GN_DS_E_3_1

1/32 DIN Digital Panel Meter for Downsizing Equipment and Control Panels

- Compact size: 48 x 24 x 83 (W x H x D).
- Multi-input compatible: DC voltage/current, rotary pulse.
- Two display colors (switchable): green/red.
- Selectable outputs.
- CE marking and UL/CSA approval.
- Splash-proof construction (NEMA4X: equivalent to IP66).

 Refer to *Safety Precautions for All Digital Panel Meters*.



Model Number Structure

■ Model Number Legend

K3GN-□□-□-□ 24 VDC
 1 2 3 4

1. Input Type

- ND: DC voltage/current, NPN
PD: DC voltage/current, PNP

2. Output Type

- C: 2 relay contact outputs (SPST-NO)
C-FLK: 2 relay contact outputs (SPST-NO) and RS-485
C-L1: 2 relay contact outputs (SPST-NO) and DC current (0 to 20 mA, 4 to 20 mA)
C-L2: 2 relay contact outputs (SPST-NO) and DC voltage (0 to 5 V, 1 to 5 V, 0 to 10 V)
T1: 3 transistor outputs (NPN open collector)
T1-FLK: 3 transistor outputs (NPN open collector) and RS-485
T1-L1: 3 transistor outputs (NPN open collector) and DC current (0 to 20 mA, 4 to 20 mA)
T1-L2: 3 transistor outputs (NPN open collector) and DC voltage (0 to 5 V, 1 to 5 V, 0 to 10 V)
T2: 3 transistor outputs (PNP open collector)
T2-FLK: 3 transistor outputs (PNP open collector) and RS-485

3. Option

- None: None
-400: Normally energized relays

4. Supply Voltage

- 24 VDC: 24 VDC

Ordering Information

List of Models

Supply voltage	Input type	Output type		Model
		Judgement output	Data transmission output	
24 VDC	DC voltage, DC current, or NPN input	2 relay contact outputs (SPST-NO)	None	K3GN-NDC 24 VDC
			RS-485	K3GN-NDC-FLK 24 VDC
			DC current (0 to 20 mA, 4 to 20 mA)	K3GN-NDC-L1 24 VDC
			DC voltage (0 to 5 V, 1 to 5 V, 0 to 10 V)	K3GN-NDC-L2 24 VDC
		2 relay contact outputs (SPST-NO) Normally energized relays (See note.)	None	K3GN-NDC-400 24 VDC
			RS-485	K3GN-NDC-FLK-400 24 VDC
			DC current (0 to 20 mA, 4 to 20 mA)	K3GN-NDC-L1-400 24 VDC
			DC voltage (0 to 5 V, 1 to 5 V, 0 to 10 V)	K3GN-NDC-L2-400 24 VDC
		3 transistor outputs (NPN open collector)	None	K3GN-NDT1 24 VDC
			RS-485	K3GN-NDT1-FLK 24 VDC
	DC current (0 to 20 mA, 4 to 20 mA)		K3GN-NDT1-L1 24 VDC	
	DC voltage (0 to 5 V, 1 to 5 V, 0 to 10 V)		K3GN-NDT1-L2 24 VDC	
	DC voltage, DC current, or PNP input	2 relay contact outputs (SPST-NO)	None	K3GN-PDC 24 VDC
			RS-485	K3GN-PDC-FLK 24 VDC
3 transistor outputs (PNP open collector)		None	K3GN-PDT2 24 VDC	
		RS-485	K3GN-PDT2-FLK 24 VDC	

Note: Refer to page 5 for information on models with normally energized relays.

Specifications

Ratings

Item		K3GN-ND With DC voltage, DC current, and NPN input	K3GN-PD With DC voltage, DC current, and PNP input
Supply voltage		24 VDC	
Operating voltage range		85% to 110% of the rated supply voltage	
Power consumption (at max. load) (See note 1.)		2.5 W max. (at max. DC load with all indicators lit)	
Input signal		DC voltage, DC current, no-voltage contact, open collector	
DC voltage/current input	A/D conversion	Double integral method	
Pulse signal input	Pulse measurement method	Periodic measurement method	
External power supply		None	
Control input		Present value hold or forced zero (selectable) (See note 2.)	
Outputs (Outputs depend on the model.)	Relay contact output	1 A, 30 VDC (resistive load), mechanical life: 50,000,000 operations min., electrical life: 100,000 operations min.	
	Transistor output	Max. load voltage: 24 VDC, Max. load current: 50 mA, Leakage current: 100 μ A max.	
	Communications output	RS-485 (2-wire, half-duplex)	
	Linear output	DC current (0 to 20 mA DC, 4 to 20 mA): Load: 500 Ω max., Resolution: Approx. 10,000 DC voltage (0 to 5 VDC, 1 to 5 VDC, 0 to 10 VDC): Load: 5k Ω min., Resolution: Approx. 10,000	---
Display		Negative LCD (backlit LCD) display 7-segment digital display, character height: 7.0 mm, and single illuminated display	
Main functions		Scaling, prescaling, teaching, average processing, forced zero, display color selection, output type selection, key protection, startup compensation timer, hysteresis	
Ambient temperature		Operating: -10°C to 55°C (with no condensation or icing) Storage: -25°C to 65°C (with no condensation or icing)	
Ambient humidity		Operating: 25% to 85%	
Altitude		2,000 m max.	
Accessories		Rubber packing, fixture, operation manual	

Note: 1. A control power supply capacity greater than the rated capacity is required when the Digital Panel Meter is turned ON. Do not forget to take this into consideration when using several Digital Panel Meters. When power is supplied, all indicators will light and outputs will be OFF. When using startup compensation time operation, the display will read "00000" and all outputs will be OFF.

2. Enabled only when using DC voltage/current input. (Min.time for control signal input: 80 ms)

Characteristics

Item	K3GN-ND With DC voltage, DC current, and NPN input		K3GN-PD With DC voltage, DC current, and PNP input
	Input signal	DC voltage/current (4 to 20 mA, 1 to 5 V, ±5 V, ±10 V) No-voltage contact (30 Hz max. with ON/OFF pulse width of 16 ms min.) Open collector (5 kHz max. with ON/OFF pulse width of 90 μs min.)	
Displayable range	5 digits (-19999 to 99999)		
Sampling period	250 ms		
Display refresh period	Sampling period: 250 ms (at 4 Hz min.), 250 × Number of averaging times (ms) (with average processing selected), Input pulse cycle (at less than 4 Hz): Input pulse cycle × Number of averaging times		
Comparative output response time (transistor outputs)	750 ms max. (transistor output) (The time required for the judgment output to be output if the input signal rapidly changes from 15% to 95% or from 95% to 15%.)		
Linear output response time	750 ms max. (The time required for the analog output to be output if the output signal rapidly changes from 15% to 95% or from 95% to 15%.)	---	
Insulation resistance	20 MΩ min. (at 500 VDC) between external terminal and case. Insulation provided between inputs, outputs, and power supply.		
Dielectric strength	1,000 VAC for 1 min between external terminal and case.		
Noise immunity	±480 V on power supply terminals in normal mode, ±1,500 V in common mode, ±1 μs, or 100 ns for square-wave noise with 1 ns		
Vibration resistance	Vibration frequency: 10 to 55 Hz, Acceleration: 50 m/s ² for 10 min each in X, Y, and Z directions		
Shock resistance	Models with transistor outputs: 150 m/s ² three times each in 3 axes, 6 directions Models with contact outputs: 100 m/s ² three times each in 3 axes, 6 directions		
Weight	Approx. 100 g (Main Unit only)		
Degree of protection	Front panel	NEMA4X for indoor use (equivalent to IP66),	
	Rear case	IP20	
	Terminals	IP00 and finger protection (VDE0106/100)	
Memory protection	Non-volatile memory (EEPROM) (possible to rewrite 100,000 times)		
Approved standards	UL508, CSA C22.2 No. 142		
EMC	(EMI) Emission Enclosure: EN 61326 (EMS) Immunity ESD: EN 61326 Immunity RF-interference: EN 61000-4-2: Immunity Fast Transient Noise: EN 61000-4-3: Immunity Burst Noise: EN 61000-4-4: Immunity Surge: EN 61000-4-5: Immunity Conducted Disturbance: EN 61000-4-6: Immunity Power Frequency Magnetic: EN 61000-4-8:	Industry EN55011 Group 1 class A Industry 4 kV (contact discharge) 8 kV (air discharge) 10 V/m (amplitude-modulated, 80 MHz to 1 GHz) 2 kV (power line) 1 kV line to line (I/O signal line) 2 kV line to ground (power line) 3 V (0.15 to 80 MHz) 30 A/m (50 Hz) continuous time	

Input Ranges: Measurement Range and Accuracy

Input type 入力種別	Analog アナログ					Pulse パルス			Remote リモート
	DC current input	DC voltage input				Rotary pulse			
Analog range アナログ範囲	4 to 20 mA 4-20	Analog range アナログ範囲	1 to 5 V 1-5	±5 V 5	±10 V 10	Pulse frequency パルス周波数	30 Hz 30	5 kHz 5K	Range of display from 19999 to 99999 using communications.
Connection terminal	⑤-⑥	Connection terminal	④-⑤			Connection terminal	②-③		
Current range (mA)		Voltage range (V)				Frequency range (Hz)			
Input impedance	60 Ω	Input impedance	1 MΩ min.			---			
Measurement accuracy	±0.1% full scale ± one digit max. (at 23±3°C)		±0.1% full scale ± one digit max. (at 23±5°C)		±0.1% full scale ± one digit max. (at 23±5°C)			---	

Note: The shaded ranges indicate default settings.

■ Input/Output Ratings

Relay Contact Output

(Incorporating G6K Relays)

Item	Resistive load ($\cos\phi = 1$)
Rated load	1 A at 30 VDC
Rated through current	1 A max. (at COM terminal)
Max. contact voltage	60 VDC
Max. contact current	1 A (at COM terminal)
Max. switching capacity	30 VA
Min. permissible load (P level, reference value)	10 mV, 10 μ A
Mechanical life	50,000,000 operations min. (at a switching frequency of 36,000 operations/hr)
Electrical life (at an ambient temperature of 23°C)	100,000 operations min. (at the rated load with a switching frequency of 1,800 operations/hr)

Transistor Output

Rated load voltage	24 VDC
Max. load current	50 mA
Leakage current	100 μ A max.

Communications Specifications

Item	RS-485
Communications method	2-wire, half-duplex
Synchronization method	Start-stop synchronization
Baud rate	1,200/2,400/4,800/9,600/19,200 bps
Transmission code	ASCII
Communications Reading/ Writing to the K3GN	Read/write comparative set values, read/write scaling values, enable/disable the writing of data through communications, forced-zero control, and other data.

Linear Output

Item	0 to 20 mA	4 to 20 mA	0 to 5 V	1 to 5 V	0 to 10 V
Permissible load impedance	500 Ω max.		5 k Ω min.		
Resolution	Approx. 10,000				
Output error	$\pm 0.5\%$ full scale		± 0.5 full scale. ± 0.15 V at 1 V or less (no output for 0 or less)		

Nomenclature

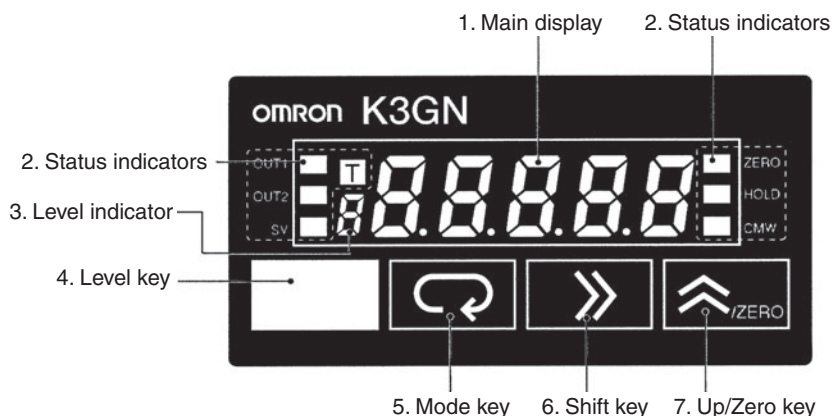

Name		Functions
1. Main display		Displays process values, parameters, and set values.
2. Status indicators	OUT1	Lit when output 1 is ON.
	OUT2	Lit when output 2 is ON.
	SV	Lit when a set value is being displayed or changed.
	T	Lit when the teaching function is enabled. Flashes when the K3GN is in teaching operation. Lit when a calibration value is being displayed during user calibration. Flashes while reading a calibration value.
	ZERO	Lit while the forced-zero function is activated.
	HOLD	Lit when HOLD input is ON.
	CMW	Lit when communications writing is "enabled" and is out when it is "disabled."
3. Level indicator		Displays the current level that the K3GN is in. (See below for details.)
4. Level Key		Used to change the level.
5. Mode Key		Used to allow the Main display to indicate parameters sequentially.
6. Shift Key		Used to enable that set value to be changed. When changing a set value, this key is used to move along the digits.
7. Up/Zero Key		Used to change a set value. Used to set or clear a forced-zero function when a measurement value is being displayed.

Level indicator	Level
P	Protect
Not lit	Operation
R	Adjustment
S	Initial setting
C	Communications setting
F	Advanced function setting
U	User calibration

Models with Normally Energized Relays K3GN-NDC-□-400 24 VDC

- The drive operation for the output relay is reversed in these models.
- Relay contacts can be made open (i.e., OFF) when comparative set values are being judged. This is effective when constructing systems that take failsafe measures into consideration.

List of Models

Models with Normally Energized Relays
K3GN-NDC-400 24 VDC
K3GN-NDC-FLK-400 24 VDC
K3GN-NDC-L1-400 24 VDC
K3GN-NDC-L2-400 24 VDC

Relation between Output Type and Relay Output Operation

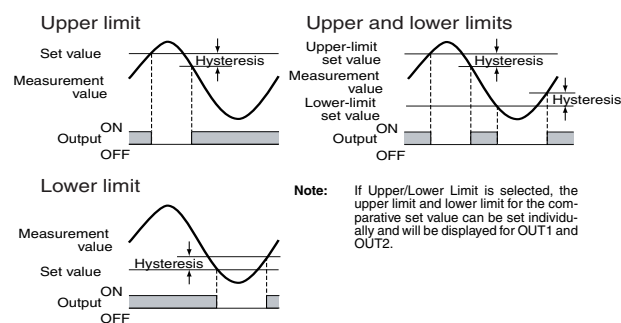

Connections

Terminal Arrangement

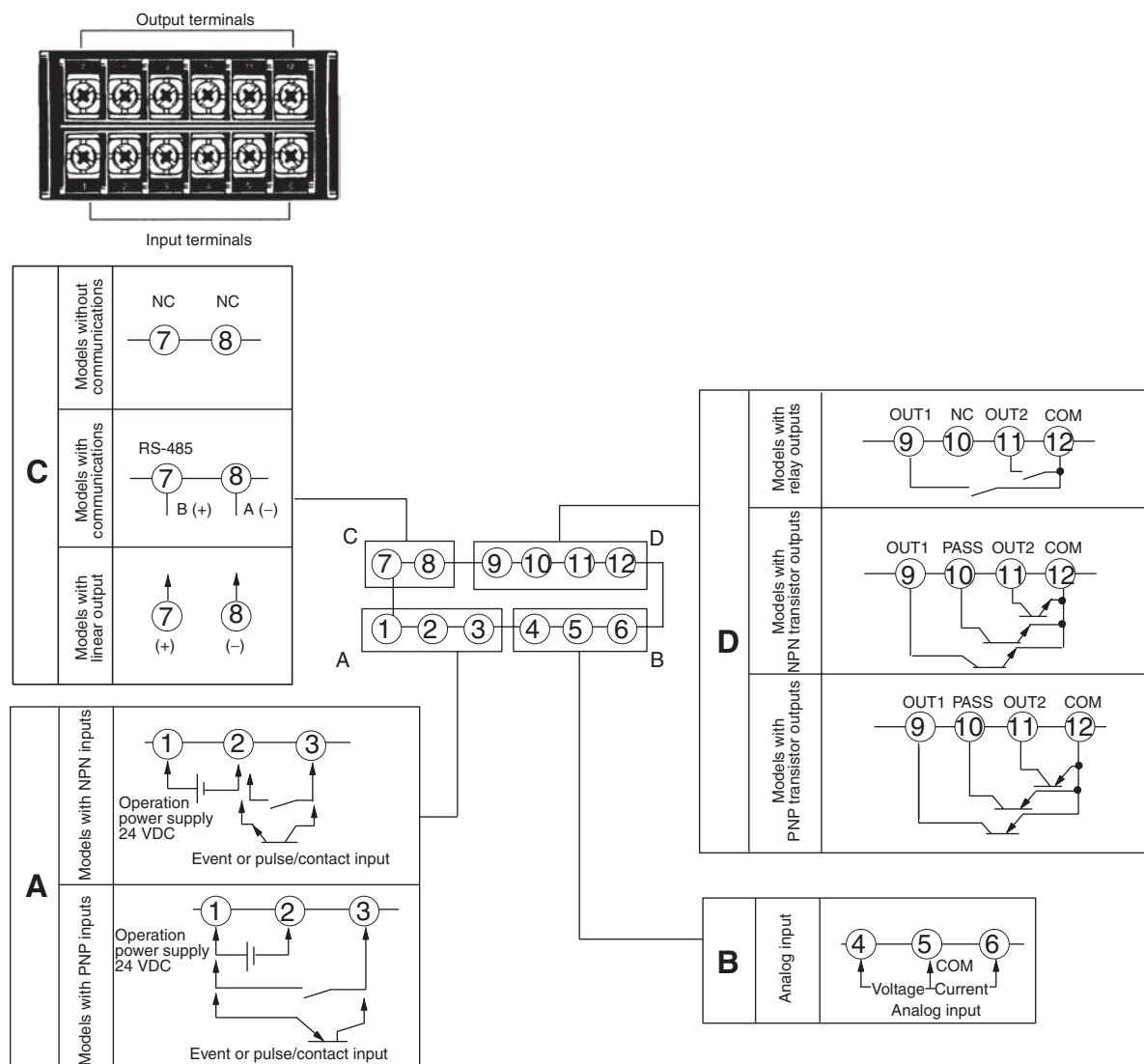

Terminal No.	Name	Description
①-②	Operation power	Connect the operation power supply.
③-②	Event input or pulse/contact input	Operates as follows depending on parameter setting: <ul style="list-style-type: none"> • Holds process value. • Calibrate the process value to zero and clear the forced-zero function. • Pulse or contact input.
③-①		
④,⑥-⑤	Analog input	Connect the voltage or current analog input.
⑦-⑧	Communications	RS-485 communications terminals.
	Linear output	0 to 20 mA DC, 4 to 20 mA DC 0 to 5 VDC, 1 to 5 VDC, 0 to 10 VDC
⑨,⑪-⑫	Outputs	Outputs relay or transistor outputs. There is also a PASS output for models with transistor outputs.
⑨,⑩,⑪-⑫		

Block Diagram

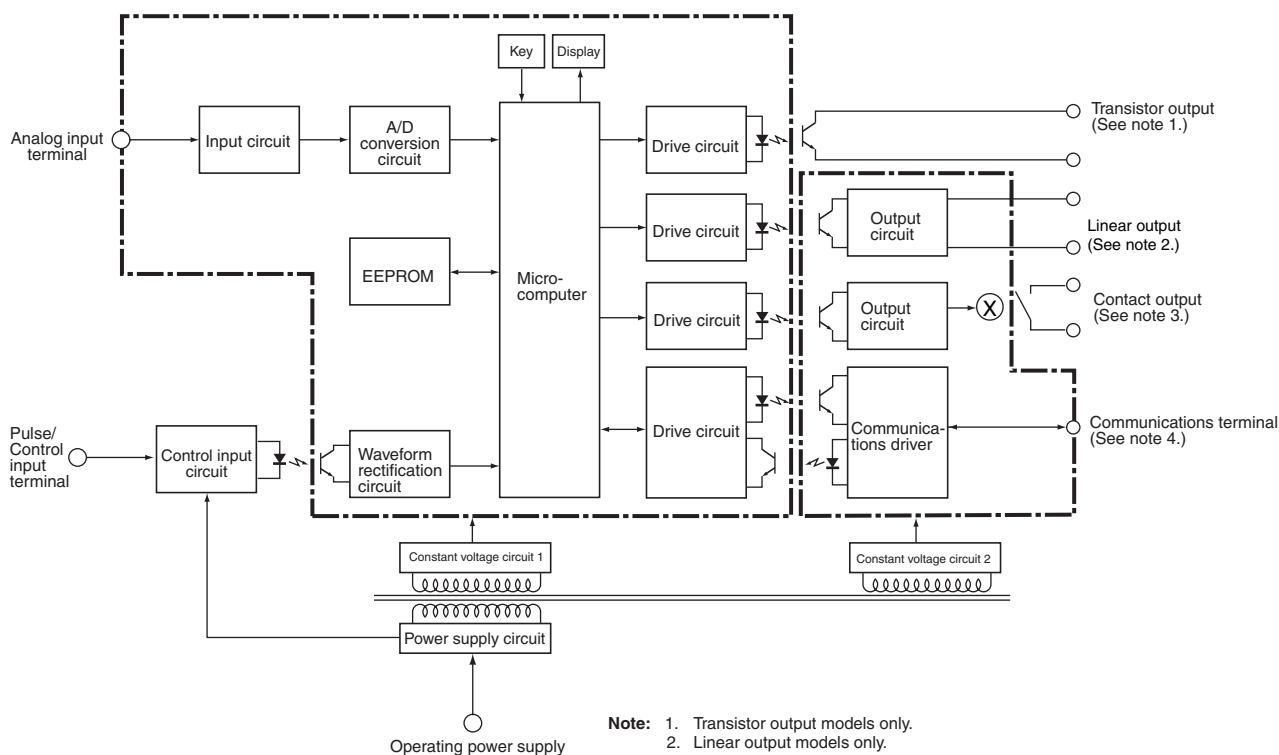

- Note:**
1. Transistor output models only.
 2. Linear output models only.
 3. Relay output models only.
 4. Models with communications functions only.

Input Circuits

Analog Input (DC Voltage/Current)

Use terminal 5 for analog common.

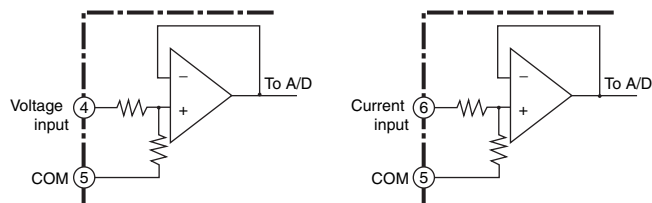

Comparative Output

Contact Output

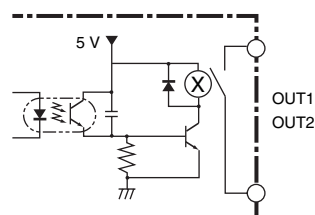

Transistor Output

NPN Output

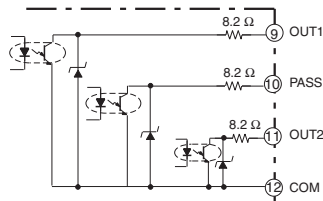

PNP Output

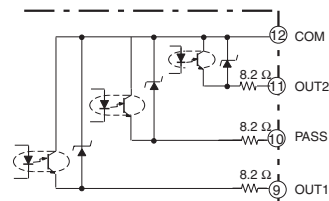

Pulse Input/ Event Input (HOLD/ZERO)

- If analog input is selected, 2 and 3 will be the event inputs. Select Hold/Zero with event input allocation.
- Use terminal 2 for the common terminal.
- Use the NPN open collector or the no-voltage contacts for the control input.

NPN Input

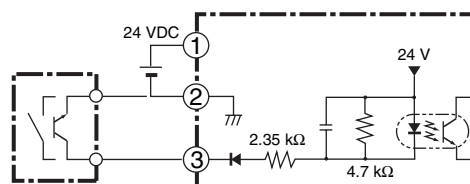

PNP Input

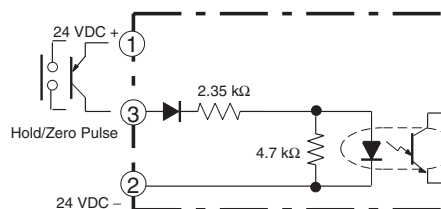

Linear Output

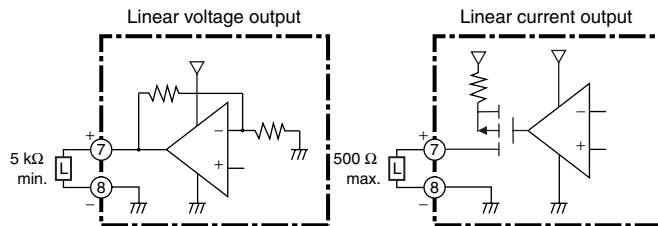

Note: The commons for linear output and transistor output on models with L1 and L2 are connected internally.

Depending on how the common is wired for externally connected devices, unwanted current paths for the linear output signal in the circuit may prevent the output signal from being output.

When connecting an external device, externally connect a relay to the transistor output or provide another means of insulation.

Operating Procedures

Initial Setting Flowchart



Input Type

Input type	Parameter	Function
Analog	\overline{ANAL}	Selects the DC voltage/current signal input.
Pulse	\overline{PULSE}	Selects the pulse input signal.
Remote	\overline{RMT}	Displays the communications remote data from the Programmable Controller.

Note: The default value is \overline{ANAL} : Analog input.

Analog Input Type

K3GN-ND□

Input specification	Parameter	Setting range
4 to 20 mA	$\overline{4-20}$	Values from –19999 to 99999 can be displayed with scaling. The position of the decimal point can be set as desired.
1 to 5 V	$\overline{1-5}$	
±5 V	$\overline{5}$	
±10 V	$\overline{10}$	

Note: The default value is $\overline{4-20}$: 4 to 20 mA input range.

K3GN-NL□ (with Microvoltage Input)

Input specification	Parameter	Setting range
±199.9 mV	$\overline{199.9}$	Values from –19999 to 99999 can be displayed with scaling. The position of the decimal point can be set as desired.
±19.99 mV	$\overline{19.99}$	

Note: The default value is $\overline{199.9}$: ±199.9 mV input range.

Pulse Frequency

Input specification	Parameter	Setting range
0.05 Hz to 30.00 Hz	$\overline{30}$	Values from –19999 to 99999 can be displayed with scaling. The position of the decimal point can be set as desired.
0 Hz to 5 kHz	$\overline{5\mu}$	

Note: The default value is $\overline{5\mu}$: 5 kHz input range.

Setting Scaling

Analog Input Signal

(Refer to page 10 if a pulse input is selected.)

- The scaling will be displayed on a line connecting two points by setting Display 1 for Input 1 and Display 2 for Input 2. The position of the decimal point can be set as desired. If the decimal point is to be displayed, it is necessary to consider the number of digits to be displayed past the decimal point when setting the scaling display value.
Note: When pulse input is used, the base point is the 0 point, so the settings are only the input value and the display value.



Instead of setting by inputting with the Shift Key and Up Key, current measurement values can be input as scaling input values for teaching. This is useful for making settings while checking the operation status of the K3GN.
 For details on the operating procedures, refer to the *K3GN Digital Panel Meter Manual* (Cat. No. N102).

- If the K3GN is used with a pulse signal input, the display value will be the input frequency if scaling is not performed.

Display the rate of rotation or the speed of a device or machine to which the K3GN is mounted by converting using scaling.

The relation between input f (Hz) and display D is expressed in the form $D = f \times a$ (a factor). The value depends on the display unit. The formula will be comprised as follows:

Display using rpm: $D = f \times 1/N \times 60$, N = Number of pulses per rotation, f = Input pulse frequency (Hz) (i.e., number of pulses in one second)

Display using m/min: $D = f \times \pi d \times 1/N \times 60$, πd = Circumference length (m) per rotation



Prescaling Example

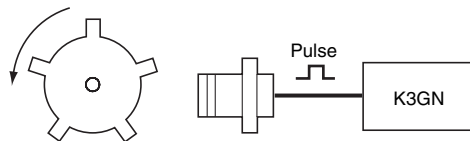

To display the rotational speed of a device that outputs five pulses per rotation:

$$D = f \times 1/5 \times 60, \text{ and,}$$

If $f=1$,

$$D = 12, \text{ so}$$

The setting will be completed by inputting $\bar{L}nP:1$ and $dSP:12$.

Output 1 Type

Output type	Parameter	Function
Upper limit	$H\bar{L}$	Output turns ON if the measurement value \geq comparative set value 1.
Lower limit	$L\bar{O}$	Output turns ON if the measurement value \leq comparative set value 1.
Upper and lower limits	$H\bar{L} - L\bar{O}$	The comparative upper-limit set value and comparative lower-limit set value can be set separately and expressed high and low. Output turns ON if the measurement value \geq comparative upper-limit set value 1 or if the measurement value is \leq comparative lower-limit set value 1.

Note: The default value is $H\bar{L}$: Upper limit.

Upper Limit

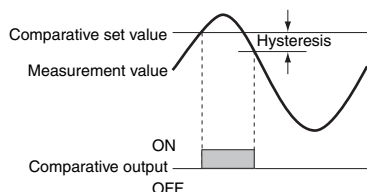

Lower Limit

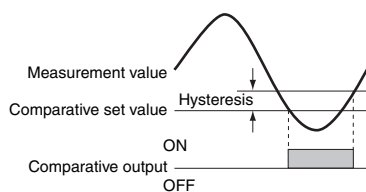

Upper and Lower Limits

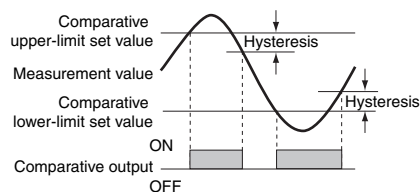

Output 2 Type

Output type	Parameter	Function
Upper limit	$H\bar{L}$	Output turns ON if the measurement value \geq comparative set value 2.
Lower limit	$L\bar{O}$	Output turns ON if the measurement value \leq comparative set value 2.
Upper and lower limit	$H\bar{L} - L\bar{O}$	The comparative upper-limit set value and comparative lower-limit set value can be set separately and expressed high and low. Output turns ON if the measurement value \geq comparative upper-limit set value 2 or if the measurement value is \leq comparative lower-limit set value 2.

Note: The default setting is $L\bar{O}$: Lower limit.

The output operations can be selected separately for OUT1 and OUT2.

Upper Limit 2-stage Output

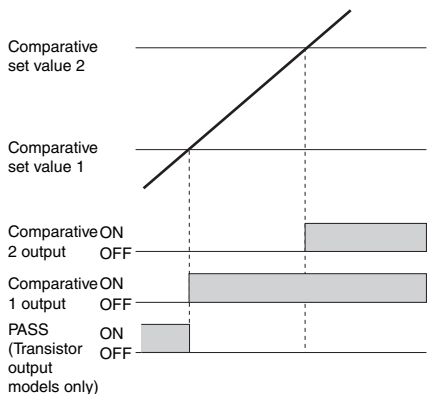

Threshold Output

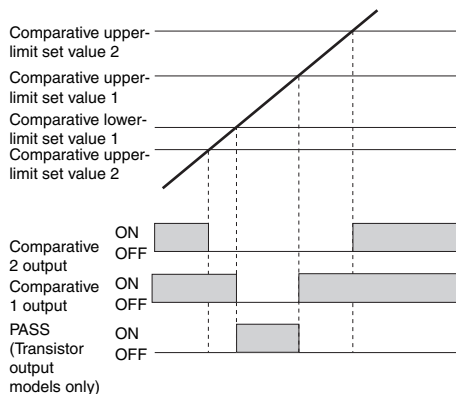

Combination of Upper Limit and Upper/Lower Limits

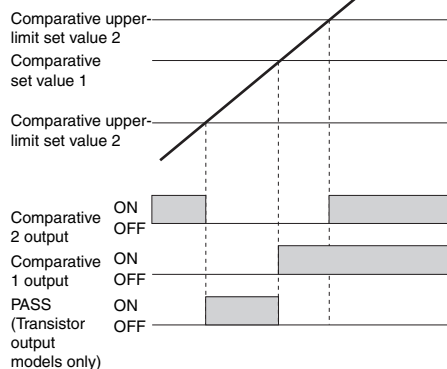

Linear Output Type

Linear output type	Parameter	Meaning of set value
Linear current type	0-20	Linear current type: 0 to 20 mA
	4-20	Linear current type: 4 to 20 mA
Linear voltage type	0-5	Linear voltage type: 0 to 5 V
	1-5	Linear voltage type: 1 to 5 V
	0-10	Linear voltage type: 0 to 10 V

Setting Menu and Parameters

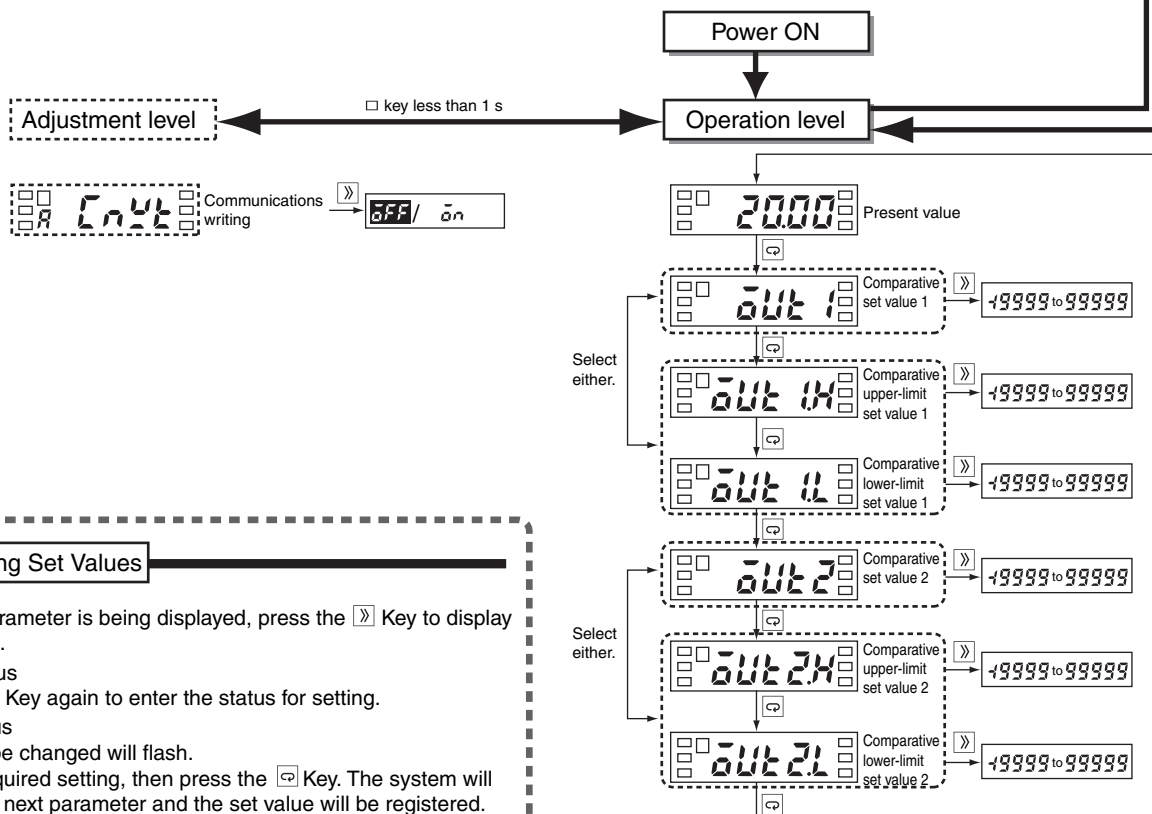
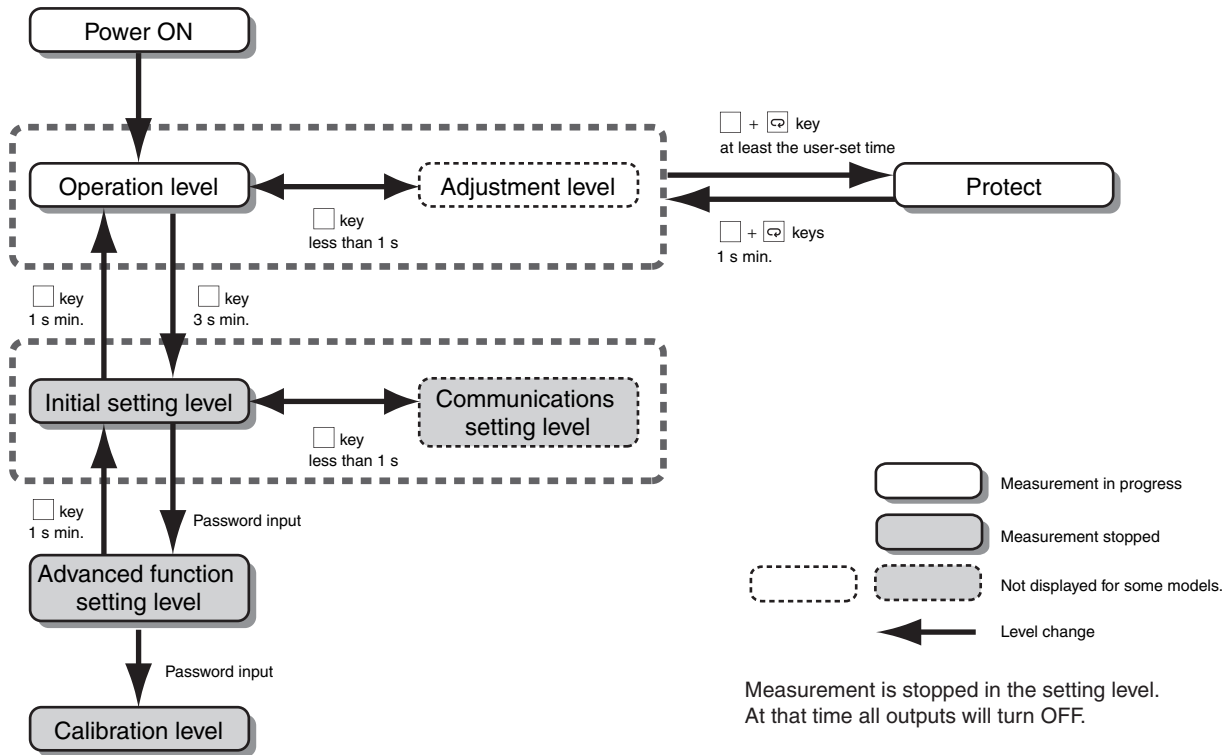

Changing Set Values

While the parameter is being displayed, press the **>** Key to display the set value.

Monitor Status
Press the **>** Key again to enter the status for setting.

Setting Status
The part to be changed will flash.

Make the required setting, then press the **<** Key. The system will switch to the next parameter and the set value will be registered.

To the next parameter

SV will flash.

Change the set value using the **<** Keys.

If 5 s lapses without any key being pressed, the set value will be registered, and the system will return to monitor status.

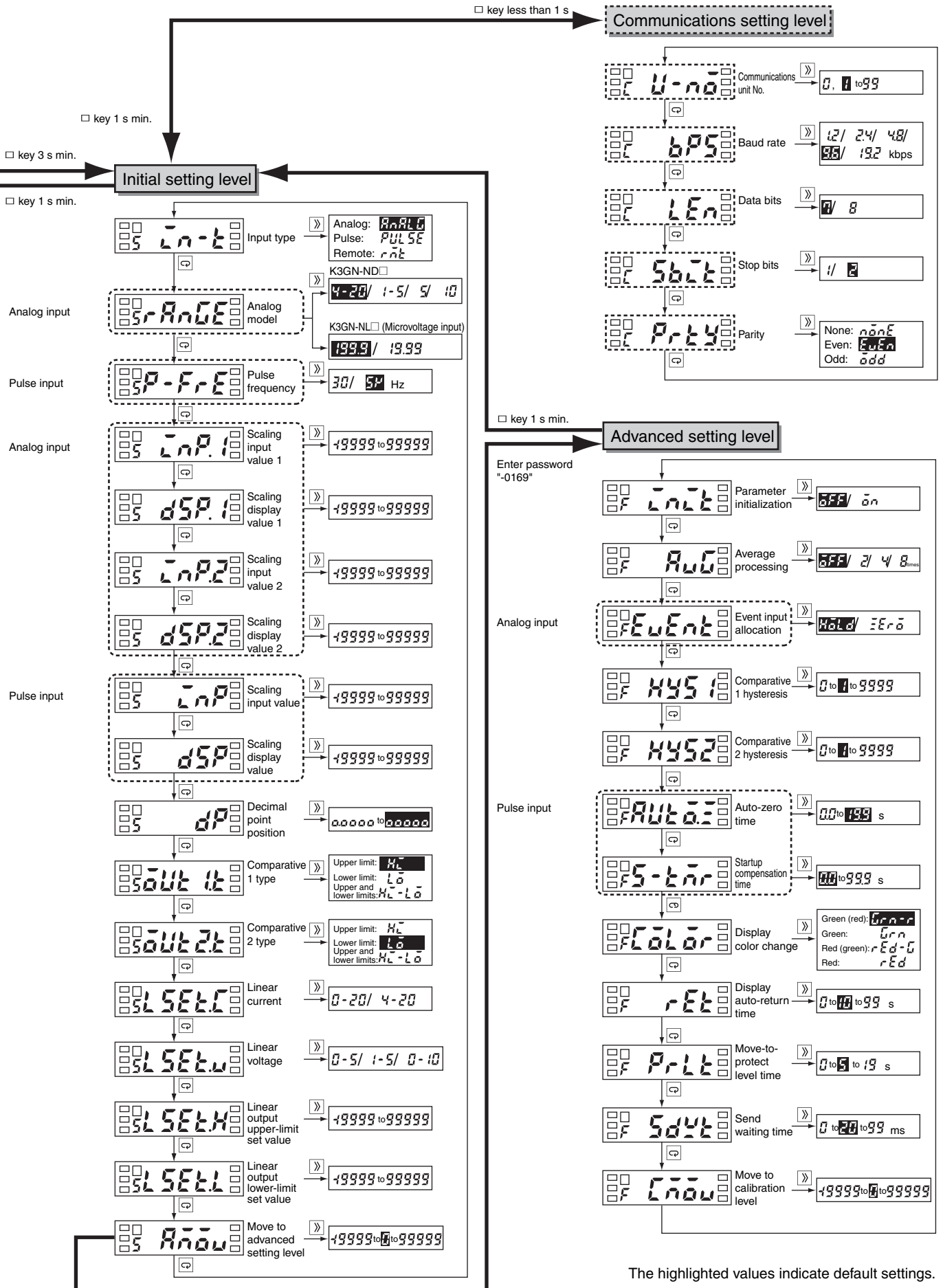

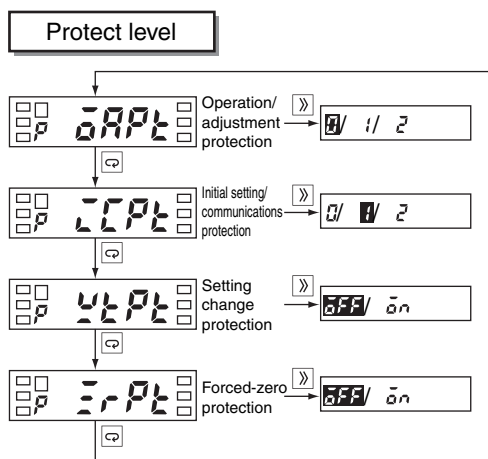

- Restricts menu display and writing in the operation level and adjustment level.
- Restricts menu display and moving for the initial setting level, communications setting level, and advanced setting level.
- Restricts changes to setup by operating the keys on the front panel.
- Restricts forced-zero operation by operating the keys on the front of the panel. (This item is not displayed if pulse input is used.)

Operation/Adjustment Protection

Restricts key operation in the operation level and adjustment level.

Setting	Operation level		Moving to adjustment level
	Present value display	Comparative value display	
0	Allowed	Allowed	Allowed
1	Allowed	Allowed	Prohibited
2	Allowed	Prohibited	Prohibited

- The default setting is 0.
- Protection is not enabled when the setting is 0 (initial setting).

Setting Change Protection

Restricts changes to settings.

Setting	Details
OFF	Changes to settings using the keys are allowed. (Moving to setting status is allowed.)
ON	Changes to settings using the keys are prohibited. (Moving to setting status is prohibited.)

- The default setting is OFF.

Note: Changes to protection level parameters, moving to advanced function setting level, and moving to calibration level are all allowed.

Initial Setting/Communications Protection

Restricts moving to the initial setting level, communications setting level, and advanced function setting level.

Setting	Moving to initial setting level	Moving to communications level
0	Allowed (message for moving to advanced function setting level displayed)	Allowed
1	Allowed (message for moving to advanced function setting level not displayed)	Allowed
2	Prohibited	Prohibited

- The default setting is 1.

Forced-zero Protection

Restricts the executing or clearing of a forced zero by using the keys.

Setting	Details
OFF	Executing or clearing of forced zero allowed.
ON	Executing or clearing of forced zero prohibited.

- The default setting is OFF.

■ Error Displays (Troubleshooting)

If an error occurs, error information will be displayed on the main display. Check the error according to the display and correct the error as indicated.

Main display	Level display	Error details	Correction
E111 (E111)	Not lit	Memory error: RAM	Cycle the power supply. If the display does not change, replacement is required. If the error is removed, the original error may have been caused by noise. Check that there are no possible sources of noise nearby.
E111 (E111)	5	Memory error: EEP	
S.Err (S.Err) flashing	Not lit	Input error or input range exceeded.	The outputs will all turn OFF. Check that the input wiring is correct, that there is no disconnection, or short-circuit, and that the input type is correct. Alternatively, limit the
99999 flashing	Not lit	Display range over: Upper limit	This is not an error. It is displayed when the display range is exceeded even if the present value is within the input range and control range. Limit the input value and display value to within the range.
-99999 Flashing	Not lit	Display range over: Lower limit	

Operation

■ Main Functions

Scaling

The K3GN includes a scaling function that can convert the input signal to a desired value and display that value.

The displayed values can be freely adjusted to shift values, to create reversed displays, or to create positive/negative displays.

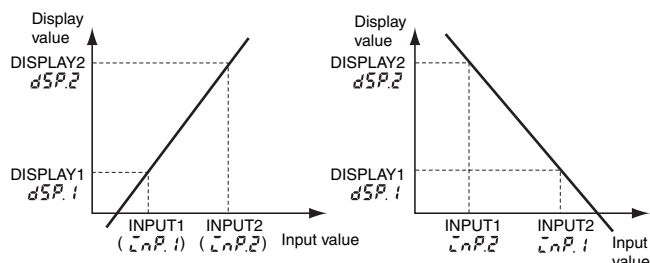

Teaching

Teaching is used when using scaling or setting comparative set values to set the present measurement values as the set values instead of inputting with the Shift and Up/Zero Keys. Teaching is useful for making settings while checking the operation status of the K3GN.

Average Processing

Average processing can be performed for measurement values using four levels (OFF, 2 times, 4 times, or 8 times). Average processing stabilizes displayed values by averaging the corresponding input signals that fluctuate dynamically. Select the appropriate number of averaging times depending on the application.

Forced-zero Function

It is possible to shift from a value to the zero point with one touch of the Up/Zero Key on the front panel (for example, when adjusting reference values).

Note: This function can be used only when forced-zero operation protection is released.

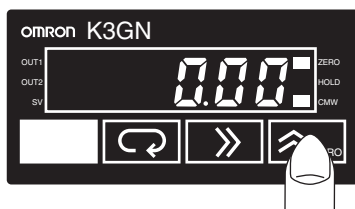

Changing the Display Color

The color of the value displayed can be set to either red or green. Make the setting according to the purpose and application of the equipment in which the K3GN is installed. The display color can also be set to change from green to red, or from red to green, according to the status of the comparison criteria.

Output Type Selection

Output operation for comparative set values can be freely selected.

Upper limit: Output ON if the measurement value \geq comparative set value.

Lower limit: Output ON if the measurement value \leq comparative set value.

Upper/lower limit: Output ON if the measurement value \geq comparative upper-limit set value or if the measurement value is \leq the comparative lower-limit value.

Key Protection

Key protection is used to restrict changes to displays and settings using the front panel keys and to restrict menu display and movement of operation levels. This function is effective for preventing misuse during operation.

Startup Compensation Time (Rotary Pulse Input Only)

The startup compensation time parameter keeps the measurement operation from sending an unnecessary output corresponding to instantaneous, fluctuating input from the moment the K3GN is turned ON until the end of the preset period.

Hysteresis

The hysteresis of comparative outputs can be set to prevent the chattering of relay or transistor outputs.

Dimensions

Note: All units are in millimeters unless otherwise indicated.

K3GN

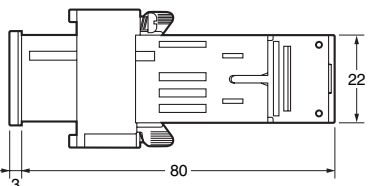
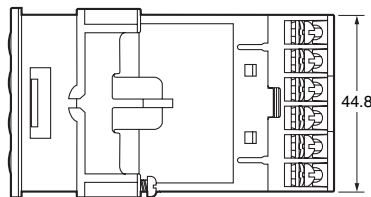
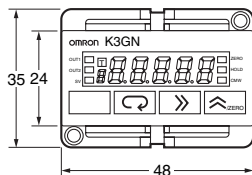

The K3GN uses M3 terminals. A terminal cover is provided.

Main Display Character Size

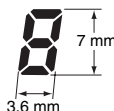

Panel Cutout Dimensions

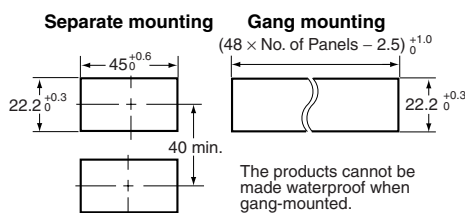

Mounting Recommended Panel Thickness 1 to 5 mm. Mount the product horizontally.

- For installation, insert the K3GN panel into the rectangular hole, insert the adaptor from the rear, and push it in to reduce the gap between the panel surface and the adaptor. Secure the Unit with the screws. For water-proof installation, insert the rubber gasket onto the body of the K3GN.
- If multiple mounted Units are used, make sure the ambient temperature for the K3GN does not exceed the specified temperature.

Installation

1. Insert the K3GN into the panel cut-out hole.
2. For a waterproof installation, insert the rubber gasket onto the body of the K3MA-J.

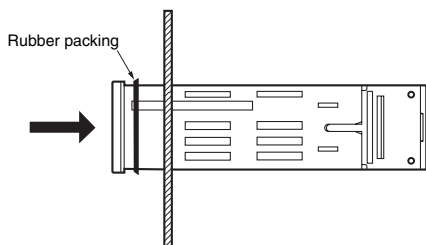

3. Fit the adaptor into the grooves on the left and right sides of the rear case, then push it until it contacts the panel to secure the K3MA-J.

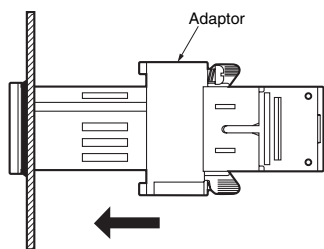

Angle of View

The K3GN is designed to provide the best visibility at the angles shown in the following diagram.

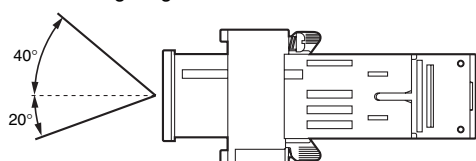

Rubber Packing

The Rubber Packing ensures a waterproof level conforming to NEMA4X. Depending on the operating environment, deterioration, contraction, or hardening of the Rubber Packing may occur, making replacement necessary. Contact your OMRON representative if replacement is required.

Wiring Precautions

- Wire the power supply with the correct polarity. Wiring with incorrect polarity may result in damage or burning.
- Wire the terminals using crimp terminals.
- Tighten terminal screws to a torque of approx. 0.5 N·m.
- Wire signal lines and power lines separately to reduce the influence of noise.

Wiring

Power Supply

- Input 24 VDC to terminals 1 and 2.

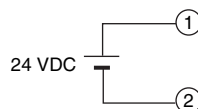

- Use M3 crimp terminals of the type shown below.

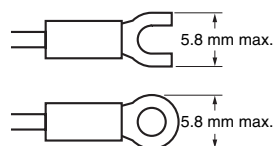

Measurement Input

The following table shows the relation between input ranges and input terminals.

Input range		Input terminals
DC voltage/DC current	4 to 20 mA	⑤-⑥
	1 to 5 V	④-⑤
	±5 V	
	±10 V	
No-voltage contacts and NPN open collector (Models with NPN inputs)		②-③
No-voltage contacts and PNP open collector (Models with PNP inputs)		①-③

Be sure to read the Precautions for Correct Use and other information required when using the K3GN in the following user's manual.
K3GN Digital Panel Meter User's Manual (Cat.No. N102)

ALL DIMENSIONS SHOWN ARE IN MILLIMETERS.

To convert millimeters into inches, multiply by 0.03937. To convert grams into ounces, multiply by 0.03527.

In the interest of product improvement, specifications are subject to change without notice.

Read and Understand This Catalog

Please read and understand this catalog before purchasing the products. Please consult your OMRON representative if you have any questions or comments.

Warranty and Limitations of Liability

WARRANTY

OMRON's exclusive warranty is that the products are free from defects in materials and workmanship for a period of one year (or other period if specified) from date of sale by OMRON.

OMRON MAKES NO WARRANTY OR REPRESENTATION, EXPRESS OR IMPLIED, REGARDING NON-INFRINGEMENT, MERCHANTABILITY, OR FITNESS FOR PARTICULAR PURPOSE OF THE PRODUCTS. ANY BUYER OR USER ACKNOWLEDGES THAT THE BUYER OR USER ALONE HAS DETERMINED THAT THE PRODUCTS WILL SUITABLY MEET THE REQUIREMENTS OF THEIR INTENDED USE. OMRON DISCLAIMS ALL OTHER WARRANTIES, EXPRESS OR IMPLIED.

LIMITATIONS OF LIABILITY

OMRON SHALL NOT BE RESPONSIBLE FOR SPECIAL, INDIRECT, OR CONSEQUENTIAL DAMAGES, LOSS OF PROFITS OR COMMERCIAL LOSS IN ANY WAY CONNECTED WITH THE PRODUCTS, WHETHER SUCH CLAIM IS BASED ON CONTRACT, WARRANTY, NEGLIGENCE, OR STRICT LIABILITY.

In no event shall the responsibility of OMRON for any act exceed the individual price of the product on which liability is asserted.

IN NO EVENT SHALL OMRON BE RESPONSIBLE FOR WARRANTY, REPAIR, OR OTHER CLAIMS REGARDING THE PRODUCTS UNLESS OMRON'S ANALYSIS CONFIRMS THAT THE PRODUCTS WERE PROPERLY HANDLED, STORED, INSTALLED, AND MAINTAINED AND NOT SUBJECT TO CONTAMINATION, ABUSE, MISUSE, OR INAPPROPRIATE MODIFICATION OR REPAIR.

Application Considerations

SUITABILITY FOR USE

OMRON shall not be responsible for conformity with any standards, codes, or regulations that apply to the combination of products in the customer's application or use of the products.

At the customer's request, OMRON will provide applicable third party certification documents identifying ratings and limitations of use that apply to the products. This information by itself is not sufficient for a complete determination of the suitability of the products in combination with the end product, machine, system, or other application or use.

The following are some examples of applications for which particular attention must be given. This is not intended to be an exhaustive list of all possible uses of the products, nor is it intended to imply that the uses listed may be suitable for the products:

- Outdoor use, uses involving potential chemical contamination or electrical interference, or conditions or uses not described in this catalog.
- Nuclear energy control systems, combustion systems, railroad systems, aviation systems, medical equipment, amusement machines, vehicles, safety equipment, and installations subject to separate industry or government regulations.
- Systems, machines, and equipment that could present a risk to life or property.

Please know and observe all prohibitions of use applicable to the products.

NEVER USE THE PRODUCTS FOR AN APPLICATION INVOLVING SERIOUS RISK TO LIFE OR PROPERTY WITHOUT ENSURING THAT THE SYSTEM AS A WHOLE HAS BEEN DESIGNED TO ADDRESS THE RISKS, AND THAT THE OMRON PRODUCTS ARE PROPERLY RATED AND INSTALLED FOR THE INTENDED USE WITHIN THE OVERALL EQUIPMENT OR SYSTEM.

PROGRAMMABLE PRODUCTS

OMRON shall not be responsible for the user's programming of a programmable product, or any consequence thereof.

Disclaimers

CHANGE IN SPECIFICATIONS

Product specifications and accessories may be changed at any time based on improvements and other reasons.

It is our practice to change model numbers when published ratings or features are changed, or when significant construction changes are made. However, some specifications of the products may be changed without any notice. When in doubt, special model numbers may be assigned to fix or establish key specifications for your application on your request. Please consult with your OMRON representative at any time to confirm actual specifications of purchased products.

DIMENSIONS AND WEIGHTS

Dimensions and weights are nominal and are not to be used for manufacturing purposes, even when tolerances are shown.

PERFORMANCE DATA

Performance data given in this catalog is provided as a guide for the user in determining suitability and does not constitute a warranty. It may represent the result of OMRON's test conditions, and the users must correlate it to actual application requirements. Actual performance is subject to the OMRON Warranty and Limitations of Liability.

ERRORS AND OMISSIONS

The information in this document has been carefully checked and is believed to be accurate; however, no responsibility is assumed for clerical, typographical, or proofreading errors, or omissions.

2009.11

In the interest of product improvement, specifications are subject to change without notice.

OMRON Corporation
Industrial Automation Company

<http://www.ia.omron.com/>

(c)Copyright OMRON Corporation 2009 All Right Reserved.

Компания «Океан Электроники» предлагает заключение долгосрочных отношений при поставках импортных электронных компонентов на взаимовыгодных условиях!

Наши преимущества:

- Поставка оригинальных импортных электронных компонентов напрямую с производств Америки, Европы и Азии, а так же с крупнейших складов мира;
- Широкая линейка поставок активных и пассивных импортных электронных компонентов (более 30 млн. наименований);
- Поставка сложных, дефицитных, либо снятых с производства позиций;
- Оперативные сроки поставки под заказ (от 5 рабочих дней);
- Экспресс доставка в любую точку России;
- Помощь Конструкторского Отдела и консультации квалифицированных инженеров;
- Техническая поддержка проекта, помощь в подборе аналогов, поставка прототипов;
- Поставка электронных компонентов под контролем ВП;
- Система менеджмента качества сертифицирована по Международному стандарту ISO 9001;
- При необходимости вся продукция военного и аэрокосмического назначения проходит испытания и сертификацию в лаборатории (по согласованию с заказчиком);
- Поставка специализированных компонентов военного и аэрокосмического уровня качества (Xilinx, Altera, Analog Devices, Intersil, Interpoint, Microsemi, Actel, Aeroflex, Peregrine, VPT, Syfer, Eurofarad, Texas Instruments, MS Kennedy, Miteq, Cobham, E2V, MA-COM, Hittite, Mini-Circuits, General Dynamics и др.);

Компания «Океан Электроники» является официальным дистрибьютором и эксклюзивным представителем в России одного из крупнейших производителей разъемов военного и аэрокосмического назначения «JONHON», а так же официальным дистрибьютором и эксклюзивным представителем в России производителя высокотехнологичных и надежных решений для передачи СВЧ сигналов «FORSTAR».



JONHON

«JONHON» (основан в 1970 г.)

Разъемы специального, военного и аэрокосмического назначения:

(Применяются в военной, авиационной, аэрокосмической, морской, железнодорожной, горно- и нефтедобывающей отраслях промышленности)

«FORSTAR» (основан в 1998 г.)

ВЧ соединители, коаксиальные кабели, кабельные сборки и микроволновые компоненты:

(Применяются в телекоммуникациях гражданского и специального назначения, в средствах связи, РЛС, а так же военной, авиационной и аэрокосмической отраслях промышленности).



Телефон: 8 (812) 309-75-97 (многоканальный)

Факс: 8 (812) 320-03-32

Электронная почта: ocean@oceanchips.ru

Web: <http://oceanchips.ru/>

Адрес: 198099, г. Санкт-Петербург, ул. Калинина, д. 2, корп. 4, лит. А