

## Applications

- Usable Bandwidth of 79 MHz ( CH1 – 13)
- For WLAN coexistence to B7, B38, B40 and B41 LTE applications
- LTE gateways, datacards and routers
- WiFi antenna extractor circuits.
- High-power WLAN Access Points and Small Cells
- 2.4 GHz ISM applications
- Wi-Fi Set Top Box, Gateways and Routers-

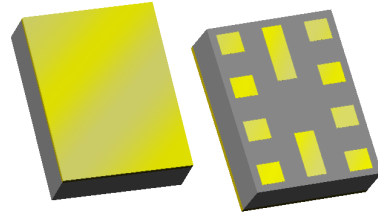

1.7 x 1.3 x 0.46 mm

## Product Features

- Diplexer is formed with WiFi Bandpass and Bandstop filters.
- Highly selective BAW filters achieving low insertion loss and high attenuation over full bandwidth and operating conditions
- Rejection in WLAN band of 10 dB minimum
- Single antenna port, diplexing
- Performance -40 to +95 °C
- RoHS compliant, Pb-free module package

## General Description

The 885137 is a high-performance Bulk Acoustic Wave (BAW) filter module designed to meet the strict LTE requirements for use in LTE from 699–2400 MHz and 2496–2690 MHz and WLAN requirements.

885137 is specifically designed to meet the high performance expectations of insertion loss and rejection for LTE and WLAN systems under all operating conditions. 885137 allows diplexing the Cellular path and a filtered WiFi path to one antenna port.

The 885137 uses common module packaging techniques to achieve the industry standard 1.7 x 1.3 x 0.46 mm footprint.

## Functional Block Diagram

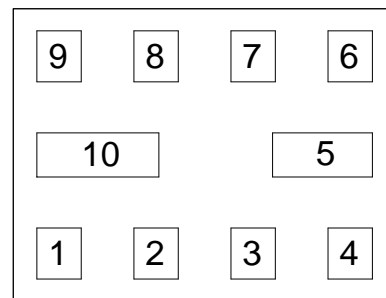

## Pin Configuration\*

Pin No.	Label
1	RF3
4	RF2
6	SMD # 1 to RF2
7	SMD # 2 to RF1, SMD # 4 to Ground
9	RF1 (ANT)
2,3,5,8,10	Ground

\*Note: See Evaluation Board section page 11 for details on optimal grounding

## Ordering Information

Part No.	Description
885137	Packaged Part
885137-EVB	Evaluation board description

Standard T/R size = 15,000 units/reel

## Absolute Maximum Ratings

Parameter	Rating
Storage Temperature <sup>(1)</sup>	-55 to +150 °C
Operating Temperature <sup>(2)</sup>	-20 to +85 °C
RF Input Power	
RF2 (Cell Port)	+25 dBm
RF3 (WiFi Port)	+20 dBm

**Notes:**

1. Operation of this device outside the parameter ranges given may cause permanent damage.
2. Specifications are not guaranteed over all operating conditions.
3. TD-SCDMA, LTE continuous; simultaneously TX power presence at RF2 and RF3.

## Electrical Specifications <sup>(1)</sup>

TEMPOP = -40 to +95°C, Characteristic Impedance [Z0] = 50 Ω. (Unless otherwise noted)

### RF1 to RF2 (Ant- Cell)

Parameter <sup>(3)</sup>	Conditions	Min	Typ <sup>(2)</sup>	Max	Units
Insertion Loss	699 – 960 MHz		1.3	2.3	dB
	1574 – 1615 MHz		0.8	0.9	
	1710 – 2170 MHz		1.0	1.3	
	2300 – 2370 MHz		1.9	3.2	
	2370 – 2377.5 MHz	-	2.5	4.6	
	2496 – 2510 MHz		2.0	3.7	
	2510 – 2570 MHz		1.0	1.5	
Passband Ripple (within any 20 MHz)	2300 – 2370 MHz		0.4	1.3	dB p-p
	2396 – 2510 MHz	-	1.1	2.8	
	2510 – 2570 MHz		0.3	0.7	
VSWR (In/Out)	2300 – 2370 MHz		1.4	2.0	-
	2496 – 2510 MHz		1.9	2.9	
	2510 – 2570 MHz	-	1.4	2.1	
	2570 – 2690 MHz		1.4	2.0	

**Notes:**

1. All specifications are based on the TriQuint schematic for the reference design shown on page 5.
2. In production, devices will be tested at room temperature to a guardbanded specification to ensure electrical compliance over temperature.
3. Electrical margin has been built into design to account the variations due to temperature drift and manufacturing tolerances.

**Electrical Specifications <sup>(1)</sup>**

TEMPOP = -40 to +95°C, Characteristic Impedance [ZO] = 50 Ω. (Unless otherwise noted)

**RF1 to RF2 (Ant- Cell)**

Parameter <sup>(3)</sup>	Conditions	Min	Typ <sup>(2)</sup>	Max	Units
Attenuation <sup>(6)</sup>	2402 – 2478.64 MHz <sup>(4)</sup>	15	17		dB
	2478.64 – 2482 MHz <sup>(4)</sup>	13	17		
	ISM CH 1 <sup>(5)</sup>	20	23		
	ISM CH 2 <sup>(5)</sup>	17	21		
	ISM CH 3 <sup>(5)</sup>	16	19		
	ISM CH 4 <sup>(5)</sup>	16	19		
	ISM CH 5 <sup>(5)</sup>	16	18		
	ISM CH 6 <sup>(5)</sup>	16	18	-	
	ISM CH 7 <sup>(5)</sup>	16	19		
	ISM CH 8 <sup>(5)</sup>	17	19		
	ISM CH 9 <sup>(5)</sup>	17	22		
	ISM CH 10 <sup>(5)</sup>	21	25		
	ISM CH 11 <sup>(5)</sup>	24	26		
	ISM CH 12 <sup>(5)</sup>	19	23		
ISM CH 13 <sup>(5)</sup>	17	21			

**RF2 to RF3 Isolation (Cell - WiFi)**

Attenuation <sup>(6)</sup>	2300 – 2370 MHz	41	45		dB
	2402 – 2482 MHz <sup>(4)</sup>	18	20		
	ISM CH 1 – 13 <sup>(5)</sup>	18	20		
	2570 – 2690 MHz <sup>(4)</sup>	43	46		
	2496 – 2500 MHz	13	28	-	
	2500 – 2510 MHz	25	45		
	2510 – 2570 MHz	49	46		
	2370 – 2400 MHz	12	15		

Notes:

1. All specifications are based on the TriQuint schematic for the reference design shown on page 5.
2. In production, devices will be tested at room temperature to a guardbanded specification to ensure electrical compliance over temperature.
3. Electrical margin has been built into design to account the variations due to temperature drift and manufacturing tolerances.
4. Data is the integrated value of the linear s-parameter over a 1 MHz range in the indicated band.
5. Data is the integrated value of the linear s-parameter over 19 MHz range in the indicated band.
6. Reference to zero dB.

## Electrical Specifications <sup>(1)</sup>

TEMPOP = -40 to +95°C, Characteristic Impedance [ZO] = 50 Ω. (Unless otherwise noted)

### RF1 to RF3 (Ant- WiFi)

Parameter <sup>(3)</sup>	Conditions	Min	Typ <sup>(2)</sup>	Max	Units
Insertion Loss	2402 – 2480 MHz	-	2.6	4.2	dB
	2402 – 2475.81 MHz <sup>(4)</sup>		2.4	3.4	
	2475.81 – 2480 MHz <sup>(4)</sup>		2.4	4.3	
	ISM CH 1 – 12 <sup>(5)</sup>		1.8	2.3	
	ISM CH 1 – 13 <sup>(5)</sup>		1.8	2.7	
Passband Ripple	2402 – 2480 MHz	-	1.5	3.1	dB p-p
	2402 – 2480 MHz <sup>(within any 20 MHz)</sup>		1.3	2.7	
Attenuation <sup>(6)</sup>	10 – 1549 MHz	44	45	-	dB
	1549 – 1615 MHz	44	45		
	1710 – 1990 MHz	41	42		
	2110 – 2170 MHz	40	42		
	2300 – 2370 MHz	46	48		
	2496 – 2500 MHz	12	25		
	2500 – 2570 MHz	22	39		
2570 – 2690 MHz	42	44			
VSWR (In/Out)	2402 – 2480 MHz	-	1.7	2.6	-

Notes:

1. All specifications are based on the TriQuint schematic for the reference design shown on page 5.
2. In production, devices will be tested at room temperature to a guardbanded specification to ensure electrical compliance over temperature.
3. Electrical margin has been built into design to account the variations due to temperature drift and manufacturing tolerances
4. Data is the integrated value of the linear s-parameter over a 1 MHz range in the indicated band.
5. Data is the integrated value of the linear s-parameter over 19 MHz range in the indicated band.
6. Reference to zero dB.

## Electrical Specifications <sup>(1)</sup>

TEMPOP = -30 to +85°C, Characteristic Impedance [Z0] = 50 Ω. (Unless otherwise noted)

### RF1 to RF2 (Ant- Cell)

Parameter <sup>(3)</sup>	Conditions	Min	Typ <sup>(2)</sup>	Max	Units
Insertion Loss	699 – 960 MHz	-	1.3	2.3	dB
	1574 – 1615 MHz		0.8	0.9	
	1710 – 2170 MHz		1.0	1.2	
	2300 – 2370 MHz		1.9	3.1	
	2370 – 2377.5 MHz		2.5	4.4	
	2496 – 2510 MHz		2.0	3.6	
	2510 – 2570 MHz		1.0	1.5	
Passband Ripple (within any 20 MHz)	2300 – 2370 MHz	-	0.4	1.3	dB p-p
	2396 – 2510 MHz		1.1	2.7	
	2510 – 2570 MHz		0.3	0.7	
VSWR (In/Out)	2300 – 2370 MHz	-	1.4	2.0	-
	2496 – 2510 MHz		1.9	2.9	
	2510 – 2570 MHz		1.4	2.1	
	2570 – 2690 MHz		1.4	2.0	

Notes:

- All specifications are based on the TriQuint schematic for the reference design shown on page 5.
- In production, devices will be tested at room temperature to a guardbanded specification to ensure electrical compliance over temperature.
- Electrical margin has been built into design to account the variations due to temperature drift and manufacturing tolerances.

**Electrical Specifications <sup>(1)</sup>**

TEMPOP = -30 to +85°C, Characteristic Impedance [ZO] = 50 Ω. (Unless otherwise noted)

**RF1 to RF2 (Ant- Cell)**

Parameter <sup>(3)</sup>	Conditions	Min	Typ <sup>(2)</sup>	Max	Units
Attenuation <sup>(6)</sup>	2402 – 2478.64 MHz <sup>(4)</sup>	15	18		dB
	2478.64 – 2482 MHz <sup>(4)</sup>	14	18		
	ISM CH 1 <sup>(5)</sup>	20	25		
	ISM CH 2 <sup>(5)</sup>	17	22		
	ISM CH 3 <sup>(5)</sup>	16	20		
	ISM CH 4 <sup>(5)</sup>	16	19		
	ISM CH 5 <sup>(5)</sup>	16	19		
	ISM CH 6 <sup>(5)</sup>	16	19	-	
	ISM CH 7 <sup>(5)</sup>	16	20		
	ISM CH 8 <sup>(5)</sup>	17	21		
	ISM CH 9 <sup>(5)</sup>	17	23		
	ISM CH 10 <sup>(5)</sup>	21	26		
	ISM CH 11 <sup>(5)</sup>	24	27		
	ISM CH 12 <sup>(5)</sup>	19	26		
ISM CH 13 <sup>(5)</sup>	17	22			

**RF2 to RF3 Isolation (Cell - WiFi)**

Attenuation <sup>(6)</sup>	2300 – 2370 MHz	41	49		dB
	2402 – 2482 MHz <sup>(4)</sup>	18	19		
	ISM CH 1 – 13 <sup>(5)</sup>	18	20		
	2570 – 2690 MHz <sup>(4)</sup>	43	45		
	2496 – 2500 MHz	13	28	-	
	2500 – 2510 MHz	26	44		
	2510 – 2570 MHz	49	53		
	2370 – 2400 MHz	12	16		

Notes:

1. All specifications are based on the TriQuint schematic for the reference design shown on page 5.
2. In production, devices will be tested at room temperature to a guardbanded specification to ensure electrical compliance over temperature.
3. Electrical margin has been built into design to account the variations due to temperature drift and manufacturing tolerances.
4. Data is the integrated value of the linear s-parameter over a 1 MHz range in the indicated band.
5. Data is the integrated value of the linear s-parameter over 19 MHz range in the indicated band.
6. Reference to zero dB.

## Electrical Specifications <sup>(1)</sup>

TEMPOP = -30 to +85°C, Characteristic Impedance [ZO] = 50 Ω. (Unless otherwise noted)

### RF1 to RF3 (Ant- WiFi)

Parameter <sup>(3)</sup>	Conditions	Min	Typ <sup>(2)</sup>	Max	Units
Insertion Loss	2402 – 2480 MHz	-	2.6	4.0	dB
	2402 – 2475.81 MHz <sup>(4)</sup>		2.4	3.4	
	2475.81 – 2480 MHz <sup>(4)</sup>		2.4	4.1	
	ISM CH 1 – 12 <sup>(5)</sup>		1.8	2.2	
	ISM CH 1 – 13 <sup>(5)</sup>		1.8	2.6	
Passband Ripple	2402 – 2480 MHz	-	1.5	2.9	dB p-p
	2402 – 2480 MHz <sup>(within any 20 MHz)</sup>		1.3	2.6	
Attenuation <sup>(6)</sup>	10 – 1549 MHz	44	45	-	-
	1549 – 1615 MHz	44	45		
	1710 – 1990 MHz	41	42		
	2110 – 2170 MHz	40	42		
	2300 – 2370 MHz	46	48		
	2496 – 2500 MHz	12	25		
	2500 – 2570 MHz	23	39		
2570 – 2690 MHz	42	44			
VSWR (In/Out)	2402 – 2480 MHz	-	1.7	2.5	-

Notes:

1. All specifications are based on the TriQuint schematic for the reference design shown on page 5.
2. In production, devices will be tested at room temperature to a guardbanded specification to ensure electrical compliance over temperature.
3. Electrical margin has been built into design to account the variations due to temperature drift and manufacturing tolerances.
4. Data is the integrated value of the linear s-parameter over a 1 MHz range in the indicated band.
5. Data is the integrated value of the linear s-parameter over 19 MHz range in the indicated band.
6. Reference to zero dB.

## Electrical Specifications <sup>(1)</sup>

TEMPOP = 0 to +70 °C, Characteristic Impedance [ZO] = 50 Ω. (Unless otherwise noted)

### RF1 to RF2 (Ant- Cell)

Parameter <sup>(3)</sup>	Conditions	Min	Typ <sup>(2)</sup>	Max	Units
Insertion Loss	699 – 960 MHz		1.3	2.3	dB
	1574 – 1615 MHz		0.8	0.9	
	1710 – 2170 MHz		1.0	1.2	
	2300 – 2370 MHz		1.9	3.0	
	2370 – 2377.5 MHz	-	2.5	4.3	
	2496 – 2510 MHz		2.0	3.3	
	2510 – 2570 MHz		1.0	1.5	
2570 – 2690 MHz		1.0	1.3		
Passband Ripple (within any 20 MHz)	2300 – 2370 MHz		0.4	1.2	dB p-p
	2396 – 2510 MHz	-	1.1	2.3	
	2510 – 2570 MHz		0.3	0.6	
VSWR (In/Out)	2300 – 2370 MHz		1.4	2.0	-
	2496 – 2510 MHz		1.9	2.8	
	2510 – 2570 MHz	-	1.4	2.0	
	2570 – 2690 MHz		1.4	2.0	

Notes:

1. All specifications are based on the TriQuint schematic for the reference design shown on page 5.
2. In production, devices will be tested at room temperature to a guardbanded specification to ensure electrical compliance over temperature.
3. Electrical margin has been built into design to account the variations due to temperature drift and manufacturing tolerances.



## Electrical Specifications <sup>(1)</sup>

TEMPOP = 0 to +70 °C, Characteristic Impedance [ZO] = 50 Ω. (Unless otherwise noted)

### RF1 to RF2 (Ant- Cell)

Parameter <sup>(3)</sup>	Conditions	Min	Typ <sup>(2)</sup>	Max	Units
Attenuation <sup>(6)</sup>	2402 – 2478.64 MHz <sup>(4)</sup>	15	18		dB
	2478.64 – 2482 MHz <sup>(4)</sup>	14	18		
	ISM CH 1 <sup>(5)</sup>	21	25		
	ISM CH 2 <sup>(5)</sup>	17	22		
	ISM CH 3 <sup>(5)</sup>	16	20		
	ISM CH 4 <sup>(5)</sup>	16	19		
	ISM CH 5 <sup>(5)</sup>	16	19		
	ISM CH 6 <sup>(5)</sup>	16	19	-	
	ISM CH 7 <sup>(5)</sup>	16	20		
	ISM CH 8 <sup>(5)</sup>	17	21		
	ISM CH 9 <sup>(5)</sup>	18	23		
	ISM CH 10 <sup>(5)</sup>	22	26		
	ISM CH 11 <sup>(5)</sup>	24	27		
	ISM CH 12 <sup>(5)</sup>	20	26		
ISM CH 13 <sup>(5)</sup>	17	22			

### RF2 to RF3 Isolation (Cell - WiFi)

Attenuation <sup>(6)</sup>	2300 – 2370 MHz	41	49		dB
	2402 – 2482 MHz <sup>(4)</sup>	18	19		
	ISM CH 1 – 13 <sup>(5)</sup>	18	20		
	2570 – 2690 MHz <sup>(4)</sup>	43	45		
	2496 – 2500 MHz	14	28		
	2500 – 2510 MHz	27	44		
	2510 – 2570 MHz	49	53		
	2370 – 2400 MHz	12	16		

Notes:

1. All specifications are based on the TriQuint schematic for the reference design shown on page 5.
2. In production, devices will be tested at room temperature to a guardbanded specification to ensure electrical compliance over temperature.
3. Electrical margin has been built into design to account the variations due to temperature drift and manufacturing tolerances.
4. Data is the integrated value of the linear s-parameter over a 1 MHz range in the indicated band.
5. Data is the integrated value of the linear s-parameter over 19MHz range in the indicated band.
6. Reference to zero dB.

## Electrical Specifications <sup>(1)</sup>

TEMPOP = 0 to +70 °C, Characteristic Impedance [ZO] = 50 Ω. (Unless otherwise noted)

### RF1 to RF3 (Ant- WiFi)

Parameter <sup>(3)</sup>	Conditions	Min	Typ <sup>(2)</sup>	Max	Units
Insertion Loss	2402 – 2480 MHz	-	2.6	3.8	dB
	2402 – 2475.81 MHz <sup>(4)</sup>		2.4	3.3	
	2475.81 – 2480 MHz <sup>(4)</sup>		2.4	3.8	
	ISM CH 1 – 12 <sup>(5)</sup>		1.8	2.2	
	ISM CH 1 – 13 <sup>(5)</sup>		1.8	2.5	
Passband Ripple	2402 – 2480 MHz	-	1.5	2.7	dB p-p
	2402 – 2480 MHz <sup>(within any 20 MHz)</sup>		1.3	2.4	
Attenuation <sup>(6)</sup>	10 – 1549 MHz	44	45	-	-
	1549 – 1615 MHz	44	45		
	1710 – 1990 MHz	41	42		
	2110 – 2170 MHz	41	42		
	2300 – 2370 MHz	46	48		
	2496 – 2500 MHz	13	25		
	2500 – 2570 MHz	26	39		
2570 – 2690 MHz	42	44			
VSWR (In/Out)	2402 – 2480 MHz	1	1.7	2.4	-

Notes:

1. All specifications are based on the TriQuint schematic for the reference design shown on page 5.
2. In production, devices will be tested at room temperature to a guardbanded specification to ensure electrical compliance over temperature.
3. Electrical margin has been built into design to account the variations due to temperature drift and manufacturing tolerances.
4. Data is the integrated value of the linear s-parameter over a 1 MHz range in the indicated band.
5. Data is the integrated value of the linear s-parameter over 19 MHz range in the indicated band.
6. Reference to zero dB.

**Evaluation Board**

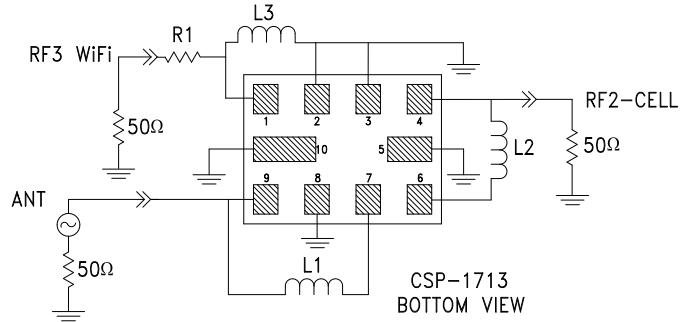
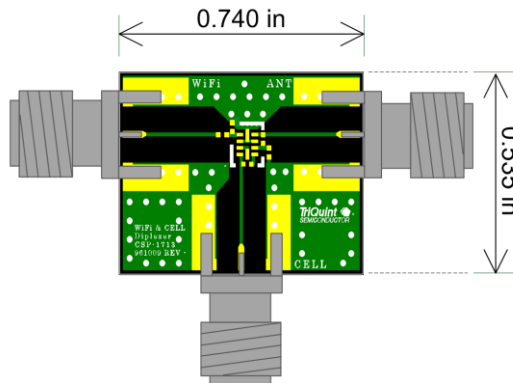

Notes:

1. This is the optimum impedance in order to achieve the performance shown.
2. PCB: 0.75 x 0.75 x 0.063; Construction: 1 OZ Cu Top, Middle and Bottom Layers; Material in between middle and top layer: TLY-5A (.0075); Material in between mid-bottom layers: FR4. (Dimensions are in inches)

**Bill of Material**

Reference Des.	Value	Description	Manuf.	Part Number
U1	n/a	Diplexer	TriQuint	885137
L1	3.2 nH	3.2 nH ± 0.1 nH; 0201 SMD	Murata	LQP03TN3N2B02
L2	3.6 nH	3.6 nH ± 0.1 nH; 0201 SMD	Murata	LQP03TN3N6B02
L3	6.2 nH	6.2 nH ± 3%; 0201 SMD	Murata	LQP03TN6N2H02
R1	0 Ω	0.0 Ohm 1/20 W jumper; 0201	Panasonic	ERJ1GN0R00C
SMA	N/A	SMA connector	Radiall	9602-1111-018
PCB	n/a	Printed Circuit Board	TriQuint	961009

**PCB Mounting Pattern**

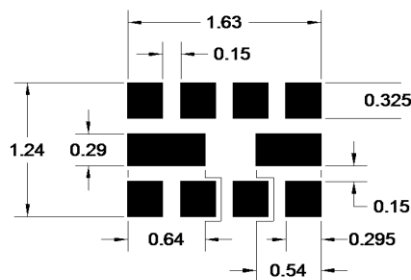

Notes:

1. All dimensions are in millimeters. Angles are in degrees.
2. This drawing specifies the mounting pattern used on the TriQuint evaluation board for this product. Some modification may be necessary to suit end user assembly materials and processes

**Performance Plots - RF1 to RF2 (Ant- Cell)**

Test conditions unless otherwise noted: Temp= +25 °C

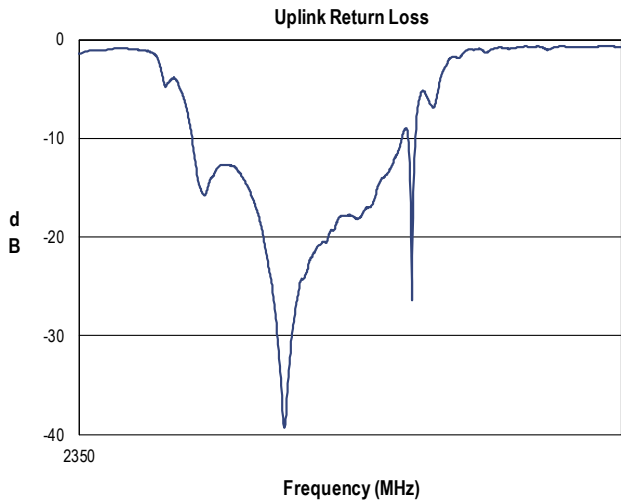
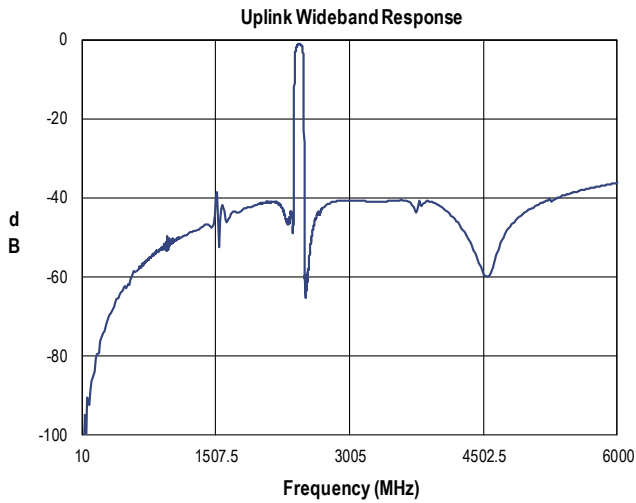
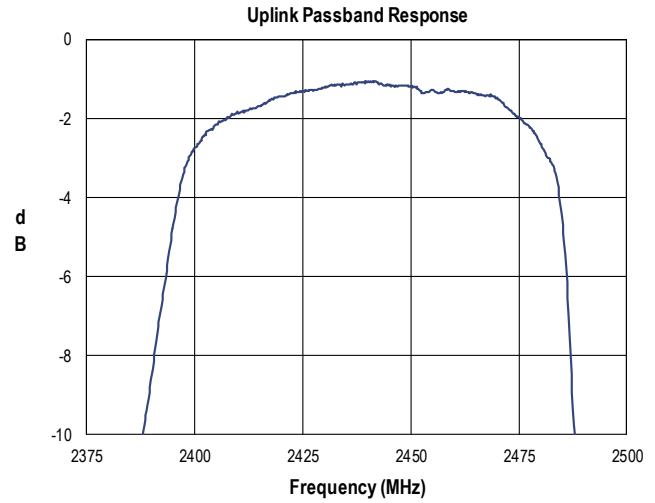
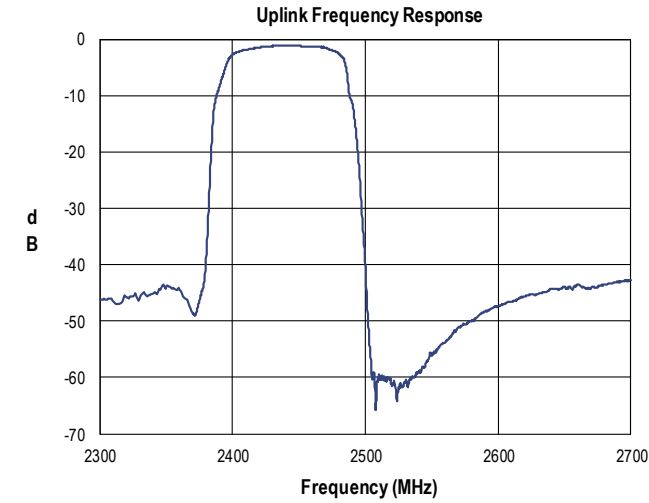

**Uplink Path - Ant Port Impedance**

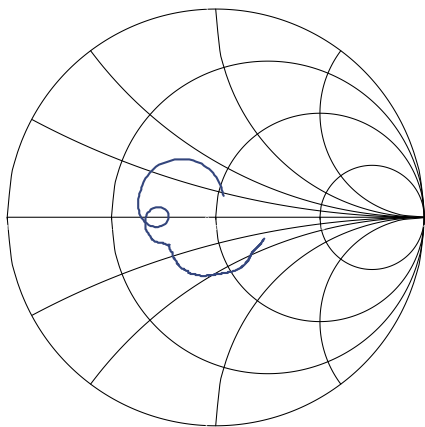

**Uplink Port Impedance**

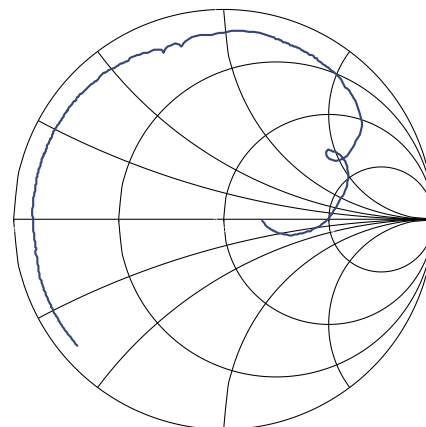

**Performance Plots - RF1 to RF3 (Ant- WiFi)**

Test conditions unless otherwise noted: Temp= +25 °C

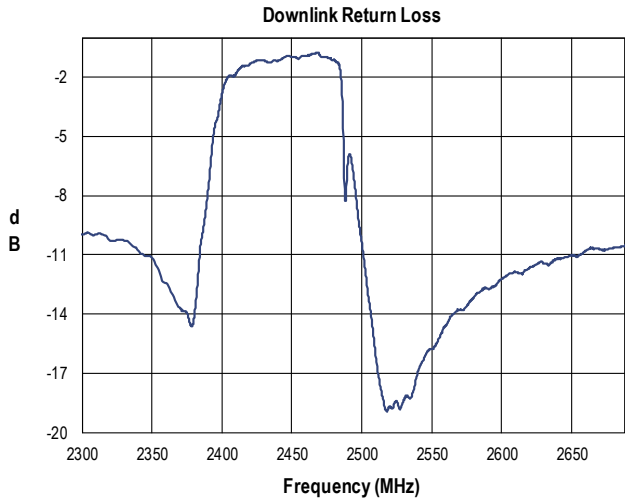
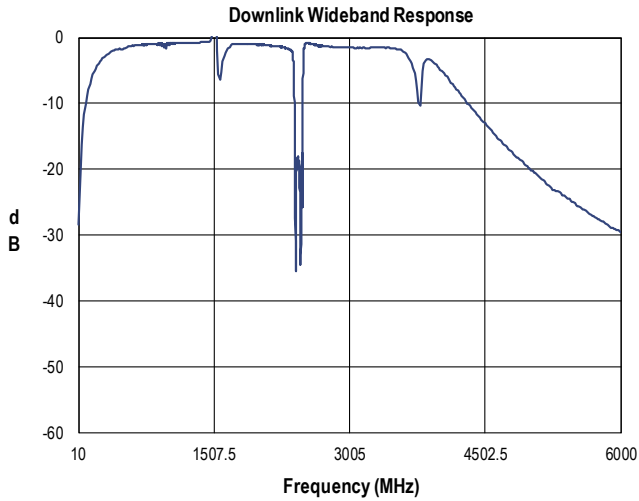
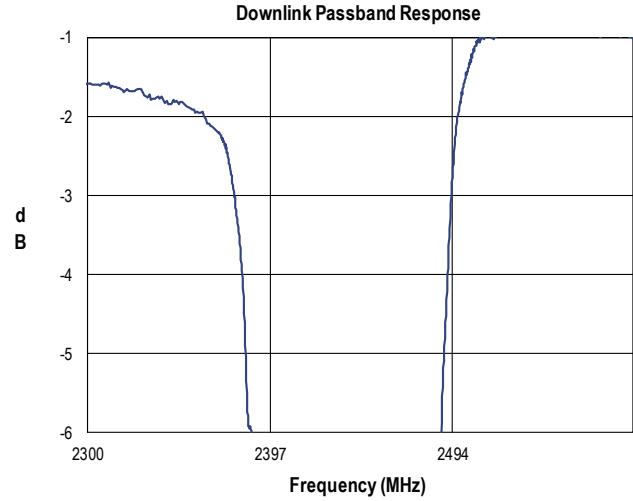
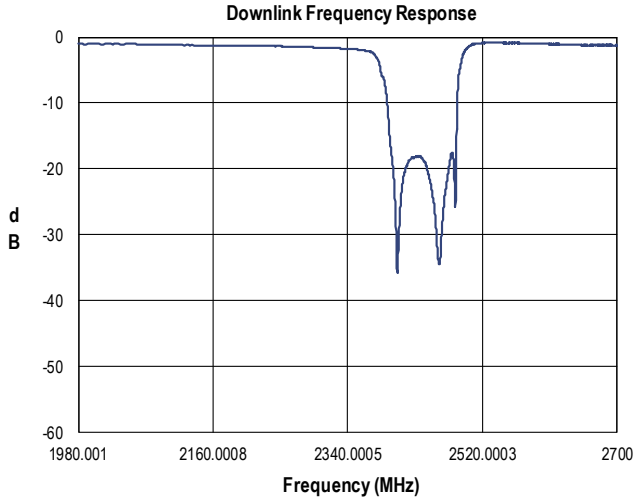

**Downlink Path - Ant Port Impedance**

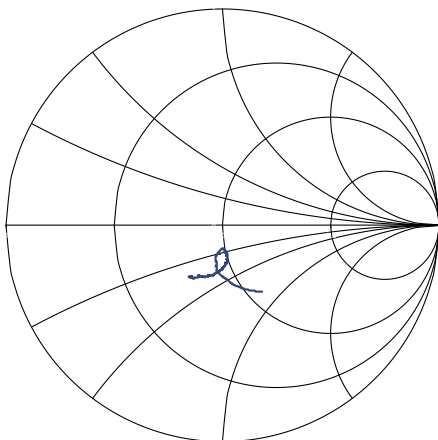

**Downlink Port Impedance**

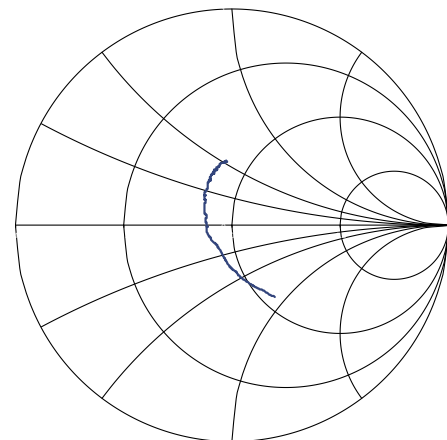

**Performance Plots - RF2 to RF3 (Cell - WiFi)**

Test conditions unless otherwise noted: Temp= +25 °C

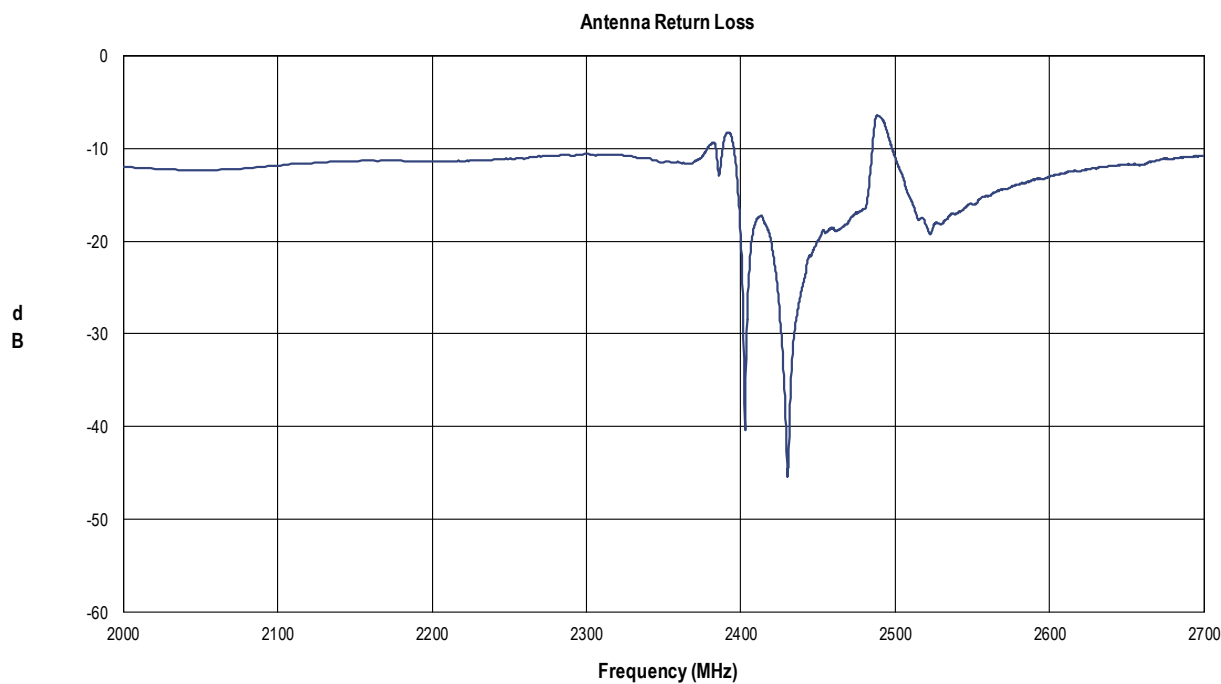
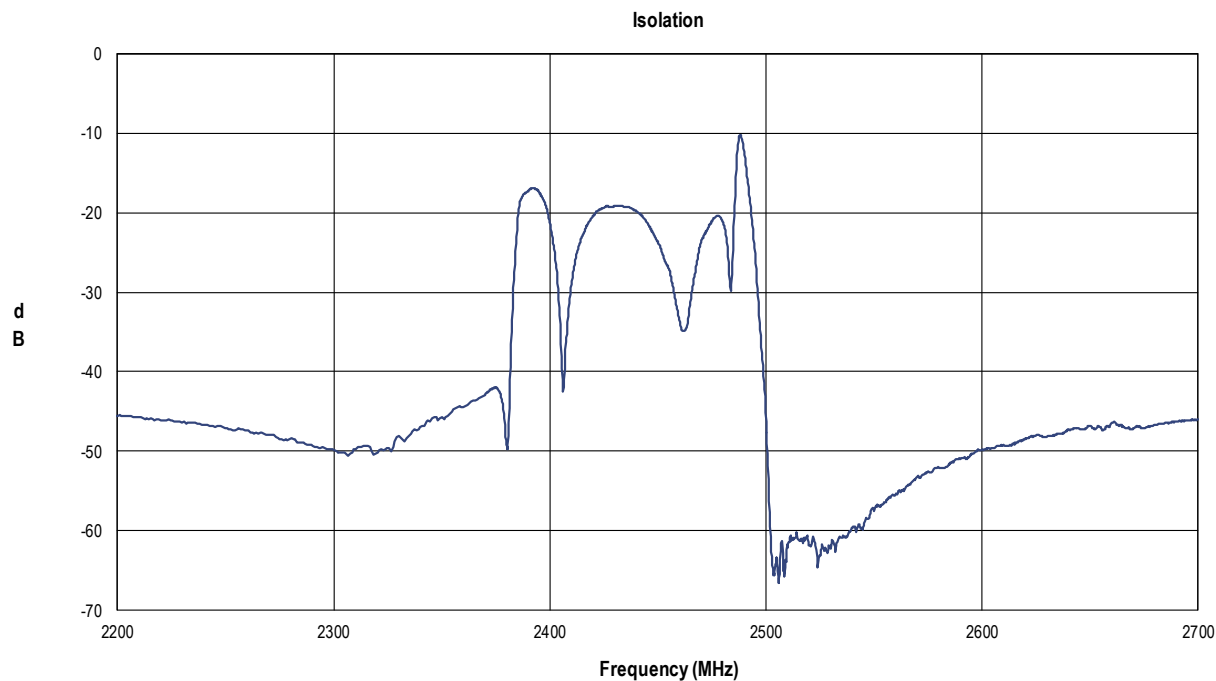

**Package Information, Marking and Dimensions**

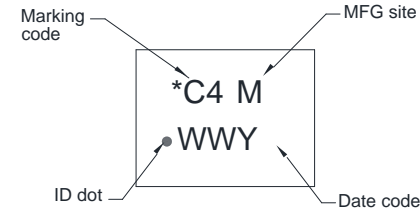

Package Style: CSP-1713  
 Dimensions: 1.7 x 1.3 x 0.46 mm

Package for Surface Mount Technology  
 Terminations: Au plating 0.5 - 1.0µm, over a 2-6µm Ni Plating  
 Approximate weight 3.96mg.

The date code consists of: WW = 2 digit week, Y = last digit of year, M = manufacturing site code.

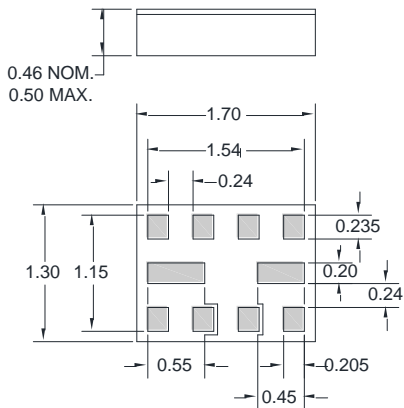

Notes:

1. All dimensions shown are typical in millimeters.
2. An asterisk (\*) in front of the marking code indicates prototype.
3. All tolerances are 0.05mm except overall length and width ±0.10mm.

**Tape and Reel information**

Standard T/R size = 15,000 units/reel

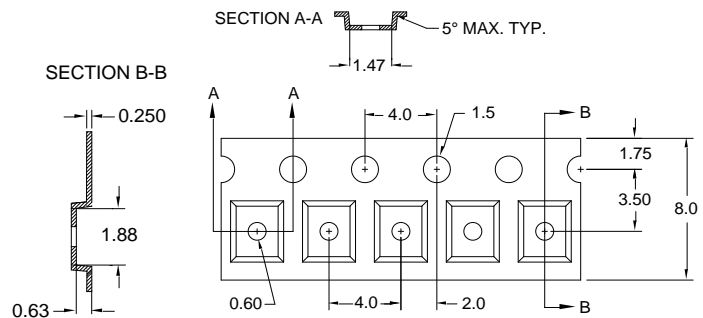
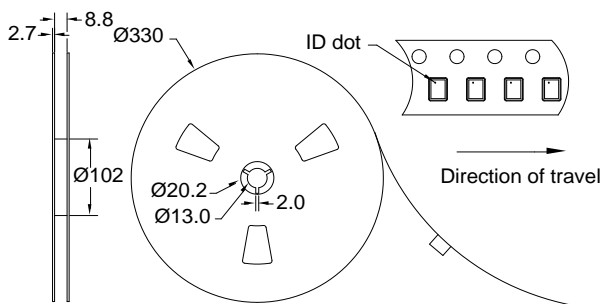

## Product Compliance Information

### ESD Sensitivity Ratings



Caution! ESD-Sensitive Device

ESD Rating: Class 1B  
Test: Human Body Model (HBM)  
Standard: JEDEC Standard JESD22-A114

ESD Rating: B  
Test: Machine Model (MM)  
Standard: JEDEC Standard JESD22-A115

### MSL Rating

MSL Rating: Not Applicable, Hermetically sealed  
Test: 260 °C convection reflow  
Standard: JEDEC Standard IPC/JEDEC J-STD-020

### Solderability

Compatible with both lead-free (260°C maximum reflow temperature) and tin/lead (245°C maximum reflow temperature) soldering processes.

Refer to [Soldering Profile](#) for recommended guidelines.

### RoHS Compliance

This part is compliant with EU 2002/95/EC RoHS directive (Restrictions on the Use of Certain Hazardous Substances in Electrical and Electronic Equipment).

This product also has the following attributes:

- Lead Free
- Halogen Free (Chlorine, Bromine)
- Antimony Free
- TBBP-A (C<sub>15</sub>H<sub>12</sub>Br<sub>4</sub>O<sub>2</sub>) Free
- PFOS Free
- SVHC Free

## Contact Information

For the latest specifications, additional product information, worldwide sales and distribution locations:

Web: [www.triquint.com](http://www.triquint.com)  
Email: [customer.support@qorvo.com](mailto:customer.support@qorvo.com)

Tel: 877-800-8584

For information about the merger of RFMD and TriQuint as Qorvo:

Web: [www.qorvo.com](http://www.qorvo.com)

For technical questions and application information:

Email: [flapplication.engineering@tqs.com](mailto:flapplication.engineering@tqs.com)

## Important Notice

The information contained herein is believed to be reliable. TriQuint makes no warranties regarding the information contained herein. TriQuint assumes no responsibility or liability whatsoever for any of the information contained herein. TriQuint assumes no responsibility or liability whatsoever for the use of the information contained herein. The information contained herein is provided "AS IS, WHERE IS" and with all faults, and the entire risk associated with such information is entirely with the user. All information contained herein is subject to change without notice. Customers should obtain and verify the latest relevant information before placing orders for TriQuint products. The information contained herein or any use of such information does not grant, explicitly or implicitly, to any party any patent rights, licenses, or any other intellectual property rights, whether with regard to such information itself or anything described by such information.

TriQuint products are not warranted or authorized for use as critical components in medical, life-saving, or life-sustaining applications, or other applications where a failure would reasonably be expected to cause severe personal injury or death.



Компания «Океан Электроники» предлагает заключение долгосрочных отношений при поставках импортных электронных компонентов на взаимовыгодных условиях!

Наши преимущества:

- Поставка оригинальных импортных электронных компонентов напрямую с производств Америки, Европы и Азии, а так же с крупнейших складов мира;
- Широкая линейка поставок активных и пассивных импортных электронных компонентов (более 30 млн. наименований);
- Поставка сложных, дефицитных, либо снятых с производства позиций;
- Оперативные сроки поставки под заказ (от 5 рабочих дней);
- Экспресс доставка в любую точку России;
- Помощь Конструкторского Отдела и консультации квалифицированных инженеров;
- Техническая поддержка проекта, помощь в подборе аналогов, поставка прототипов;
- Поставка электронных компонентов под контролем ВП;
- Система менеджмента качества сертифицирована по Международному стандарту ISO 9001;
- При необходимости вся продукция военного и аэрокосмического назначения проходит испытания и сертификацию в лаборатории (по согласованию с заказчиком);
- Поставка специализированных компонентов военного и аэрокосмического уровня качества (Xilinx, Altera, Analog Devices, Intersil, Interpoint, Microsemi, Actel, Aeroflex, Peregrine, VPT, Syfer, Eurofarad, Texas Instruments, MS Kennedy, Miteq, Cobham, E2V, MA-COM, Hittite, Mini-Circuits, General Dynamics и др.);

Компания «Океан Электроники» является официальным дистрибьютором и эксклюзивным представителем в России одного из крупнейших производителей разъемов военного и аэрокосмического назначения «JONHON», а так же официальным дистрибьютором и эксклюзивным представителем в России производителя высокотехнологичных и надежных решений для передачи СВЧ сигналов «FORSTAR».



## JONHON

«JONHON» (основан в 1970 г.)

Разъемы специального, военного и аэрокосмического назначения:

(Применяются в военной, авиационной, аэрокосмической, морской, железнодорожной, горно- и нефтедобывающей отраслях промышленности)

«FORSTAR» (основан в 1998 г.)

ВЧ соединители, коаксиальные кабели, кабельные сборки и микроволновые компоненты:

(Применяются в телекоммуникациях гражданского и специального назначения, в средствах связи, РЛС, а так же военной, авиационной и аэрокосмической отраслях промышленности).



Телефон: 8 (812) 309-75-97 (многоканальный)

Факс: 8 (812) 320-03-32

Электронная почта: [ocean@oceanchips.ru](mailto:ocean@oceanchips.ru)

Web: <http://oceanchips.ru/>

Адрес: 198099, г. Санкт-Петербург, ул. Калинина, д. 2, корп. 4, лит. А