

# PXAD184218FV

## Thermally-Enhanced High Power RF LDMOS FET

420 W, 28 V, 1805 – 1880 MHz

### Description

The PXAD184218FV is a 420-watt ( $P_{3dB}$ ) LDMOS FET with an asymmetrical design intended for use in multi-standard cellular power amplifier applications in the 1805 to 1880 MHz frequency band. Features include dual-path design, input and output matching, high gain and thermally-enhanced package with earless flanges. Manufactured with Wolfspeed's advanced LDMOS process, this device provides excellent thermal performance and superior reliability.

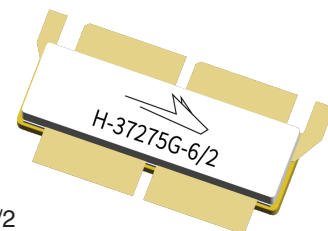

PXAD184218FV  
Package H-37275G-6/2

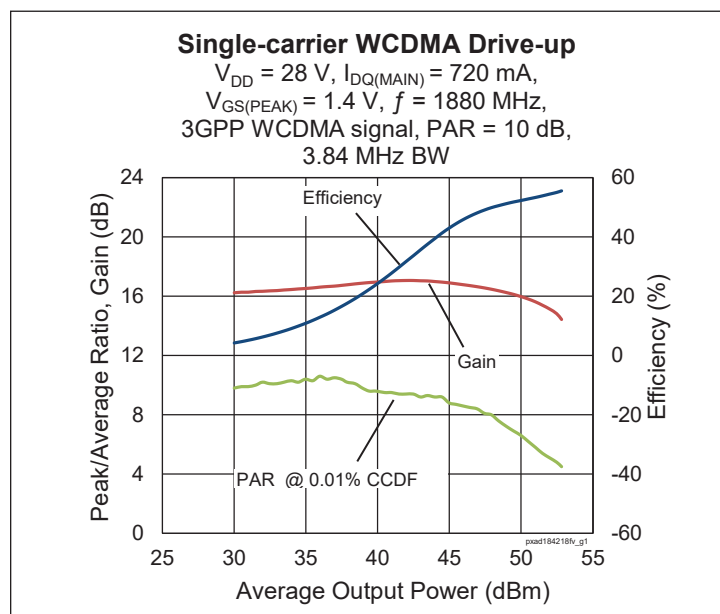

### Features

- Broadband internal input and output matching
- Asymmetrical Doherty design
  - Main :  $P_{1dB} = 130\text{ W Typ}$
  - Peak :  $P_{1dB} = 290\text{ W Typ}$
- Typical Pulsed CW performance, 1842.5 MHz, 28 V, Doherty configuration
  - Output power at  $P_{3dB} = 420\text{ W}$
  - Efficiency = 62%
  - Gain = 14 dB
- Capable of handling 10:1 VSWR @ 28 V, 110 W (WCDMA) output power
- Integrated ESD protection
- Human Body Model class 2 (per ANSI/ESDA/ JEDEC JS-001)
- Low thermal resistance
- Pb-free and RoHS compliant

### RF Characteristics

#### Two-carrier WCDMA Specifications (tested in Wolfspeed Doherty production test fixture)

$V_{DD} = 28\text{ V}$ ,  $I_{DQ} = 720\text{ mA}$ ,  $V_{GS(PEAK)} = 1.4\text{ V}$ ,  $P_{OUT} = 60\text{ W avg}$ ,  $f = 1880\text{ MHz}$ , 3GPP signal, channel bandwidth = 3.84 MHz, peak/average = 10 dB @ 0.01% CCDF

Characteristic	Symbol	Min	Typ	Max	Unit
Linear Gain	$G_{ps}$	15	16	—	dB
Drain Efficiency	$\eta_D$	49	51.5	—	%
Adjacent Channel Power Ratio	ACPR	—	-28	-25.0	dBc
Output PAR@0.01% CCDF	OPAR	6.8	7.7	—	dBc

All published data at  $T_{CASE} = 25^\circ\text{C}$  unless otherwise indicated

ESD: Electrostatic discharge sensitive device—observe handling precautions!

**DC Characteristics** (each side)

Characteristic	Conditions	Symbol	Min	Typ	Max	Unit
Drain-Source Breakdown Voltage	$V_{GS} = 0\text{ V}, I_{DS} = 10\text{ mA}$	$V_{(BR)DSS}$	65	—	—	V
Drain Leakage Current	$V_{DS} = 28\text{ V}, V_{GS} = 0\text{ V}$	$I_{DSS}$	—	—	1	$\mu\text{A}$
	$V_{DS} = 63\text{ V}, V_{GS} = 0\text{ V}$	$I_{DSS}$	—	—	10	$\mu\text{A}$
Gate Leakage Current	$V_{GS} = 10\text{ V}, V_{DS} = 0\text{ V}$	$I_{GSS}$	—	—	1	$\mu\text{A}$
On-State Resistance (Main)	$V_{GS} = 10\text{ V}, V_{DS} = 0.1\text{ V}$	$R_{DS(on)}$	—	0.03	—	$\Omega$
	(Peak) $V_{GS} = 10\text{ V}, V_{DS} = 0.1\text{ V}$	$R_{DS(on)}$	—	0.02	—	$\Omega$
Operating Gate Voltage (Main)	$V_{DS} = 28\text{ V}, I_{DQ} = 720\text{ mA}$	$V_{GS}$	2.3	2.6	2.9	V
	(Peak) $V_{DS} = 28\text{ V}, I_{DQ} = 0\text{ mA}$	$V_{GS}$	—	1.5	—	V

**Maximum Ratings**

Parameter	Symbol	Value	Unit
Drain-Source Voltage	$V_{DSS}$	65	V
Gate-Source Voltage	$V_{GS}$	-6 to +10	V
Junction Temperature	$T_J$	225	$^{\circ}\text{C}$
Storage Temperature Range	$T_{STG}$	-65 to +150	$^{\circ}\text{C}$

**Thermal Characteristics**

Parameter	Symbol	Value	Unit
Thermal Resistance (Main, $T_{CASE} = 70^{\circ}\text{C}$ , 60 W CW)	$R_{\theta JC}$	0.514	$^{\circ}\text{C}/\text{W}$
(Peak, $T_{CASE} = 70^{\circ}\text{C}$ , 280 W CW)	$R_{\theta JC}$	0.297	$^{\circ}\text{C}/\text{W}$

**Ordering Information**

Type and Version	Order Code	Package Description	Shipping
PXAD184218FV V1 R0	PXAD184218FV-V1-R0	H-37275G-6/2, earless flange	Tape & Reel, 50 pcs
PXAD184218FV V1 R2	PXAD184218FV-V1-R2	H-37275G-6/2, earless flange	Tape & Reel, 250 pcs

**Typical RF Performance** (data taken in production test fixture)

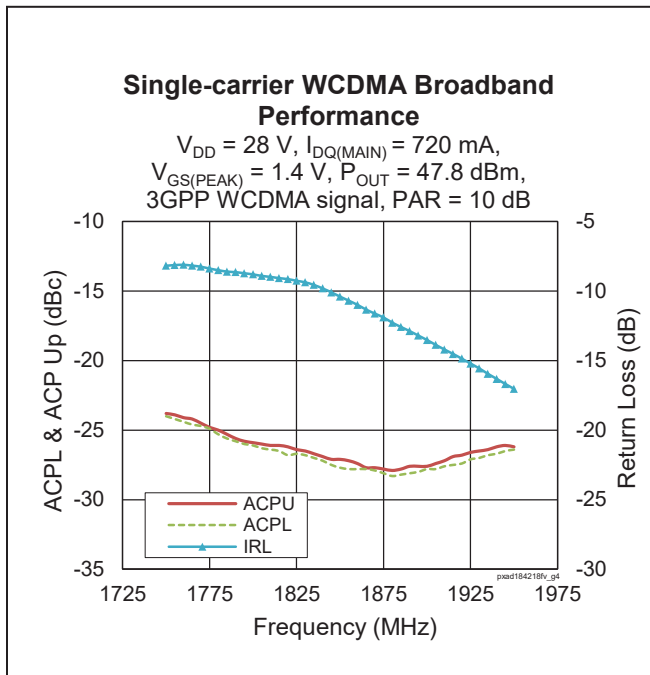
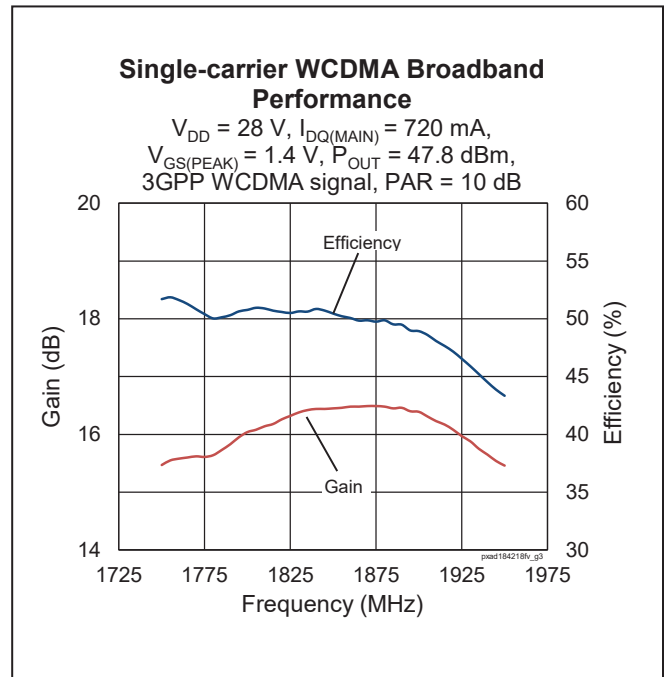
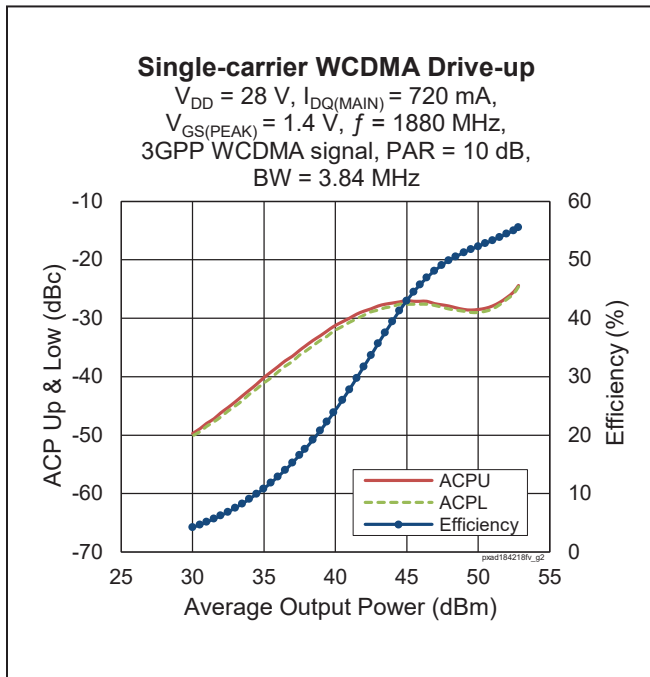



## Load Pull Performance

**Main Side Load Pull Performance** – Pulsed CW signal: 10  $\mu$ s, 10% duty cycle,  $V_{DD} = 28$  V,  $I_{DQ} = 960$  mA, class AB

		P <sub>1dB</sub>									
		Max Output Power					Max Drain Efficiency				
Freq [MHz]	Z <sub>s</sub> [ $\Omega$ ]	Z <sub>l</sub> [ $\Omega$ ]	Gain [dB]	P <sub>1dB</sub> [dBm]	P <sub>1dB</sub> [W]	$\eta^D$ [%]	Z <sub>l</sub> [ $\Omega$ ]	Gain [dB]	P <sub>1dB</sub> [dBm]	P <sub>1dB</sub> [W]	$\eta^D$ [%]
1805	2.3 - j6.3	1.6 - j3.3	20.9	52.40	173	58.7	3.5 - j3.1	23.1	50.60	116	66.6
1842.5	3.2 - j7.4	1.4 - j3.5	20.2	52.45	176	56.2	2.7 - j2.7	22.4	51.30	134	67.7
1880	5.1 - j8.9	1.4 - j3.5	20.7	52.50	180	57.4	2.7 - j 3.1	22.8	51.40	138	67.5

		P <sub>3dB</sub>									
		Max Output Power					Max Drain Efficiency				
Freq [MHz]	Z <sub>s</sub> [ $\Omega$ ]	Z <sub>l</sub> [ $\Omega$ ]	Gain [dB]	P <sub>3dB</sub> [dBm]	P <sub>3dB</sub> [W]	$\eta^D$ [%]	Z <sub>l</sub> [ $\Omega$ ]	Gain [dB]	P <sub>3dB</sub> [dBm]	P <sub>3dB</sub> [W]	$\eta^D$ [%]
1805	2.3 - j6.3	1.4 - j3.5	18.4	53.20	210	58.5	2.9 - j3.7	20.6	52.00	157	67.4
1842.5	3.2 - j7.4	1.3 - j3.6	18.1	53.29	213	58.6	2.6 - j3.3	20.2	52.20	167	68.4
1880	5.1 - j8.9	1.4 - j3.7	18.6	53.27	212	58.8	2.7 - j3.2	20.7	52.10	162	68.6

**Peak Side Load Pull Performance** – Pulsed CW signal: 10  $\mu$ s, 10% duty cycle,  $V_{DD} = 28$  V,  $I_{DQ} = 10$  mA, class B

		P <sub>1dB</sub>									
		Max Output Power					Max Drain Efficiency				
Freq [MHz]	Z <sub>s</sub> [ $\Omega$ ]	Z <sub>l</sub> [ $\Omega$ ]	Gain [dB]	P <sub>1dB</sub> [dBm]	P <sub>1dB</sub> [W]	$\eta^D$ [%]	Z <sub>l</sub> [ $\Omega$ ]	Gain [dB]	P <sub>1dB</sub> [dBm]	P <sub>1dB</sub> [W]	$\eta^D$ [%]
1805	2.1 - j4.6	1.1 - j3.3	17.1	55.38	345	54.7	2.8 - j2.2	18.7	53.27	212	66.7
1842.5	2.8 - j5.4	1.2 - j3.4	17.4	55.43	349	54.9	2.7 - j 2.2	18.8	53.30	214	66.7
1880	4.4 - j5.6	1.3 - j3.7	17.7	55.42	348	54.6	2.5 - j2.2	19.2	53.33	215	66.3

		P <sub>3dB</sub>									
		Max Output Power					Max Drain Efficiency				
Freq [MHz]	Z <sub>s</sub> [ $\Omega$ ]	Z <sub>l</sub> [ $\Omega$ ]	Gain [dB]	P <sub>3dB</sub> [dBm]	P <sub>3dB</sub> [W]	$\eta^D$ [%]	Z <sub>l</sub> [ $\Omega$ ]	Gain [dB]	P <sub>3dB</sub> [dBm]	P <sub>3dB</sub> [W]	$\eta^D$ [%]
1805	2.1 - j4.6	1.2 - j3.6	14.9	56.17	414	56.9	2.8 - j2.6	16.5	54.20	265	66.8
1842.5	2.8 - j5.4	1.2 - j3.7	15	56.20	417	56.2	2.6 - j2.7	16.6	54.40	277	67.1
1880	4.4 - j5.6	1.3 - j3.8	15.6	56.14	411	56.2	2.4 - j2.9	17	54.80	301	66.9

Reference Circuit, 1805 – 1880 MHz

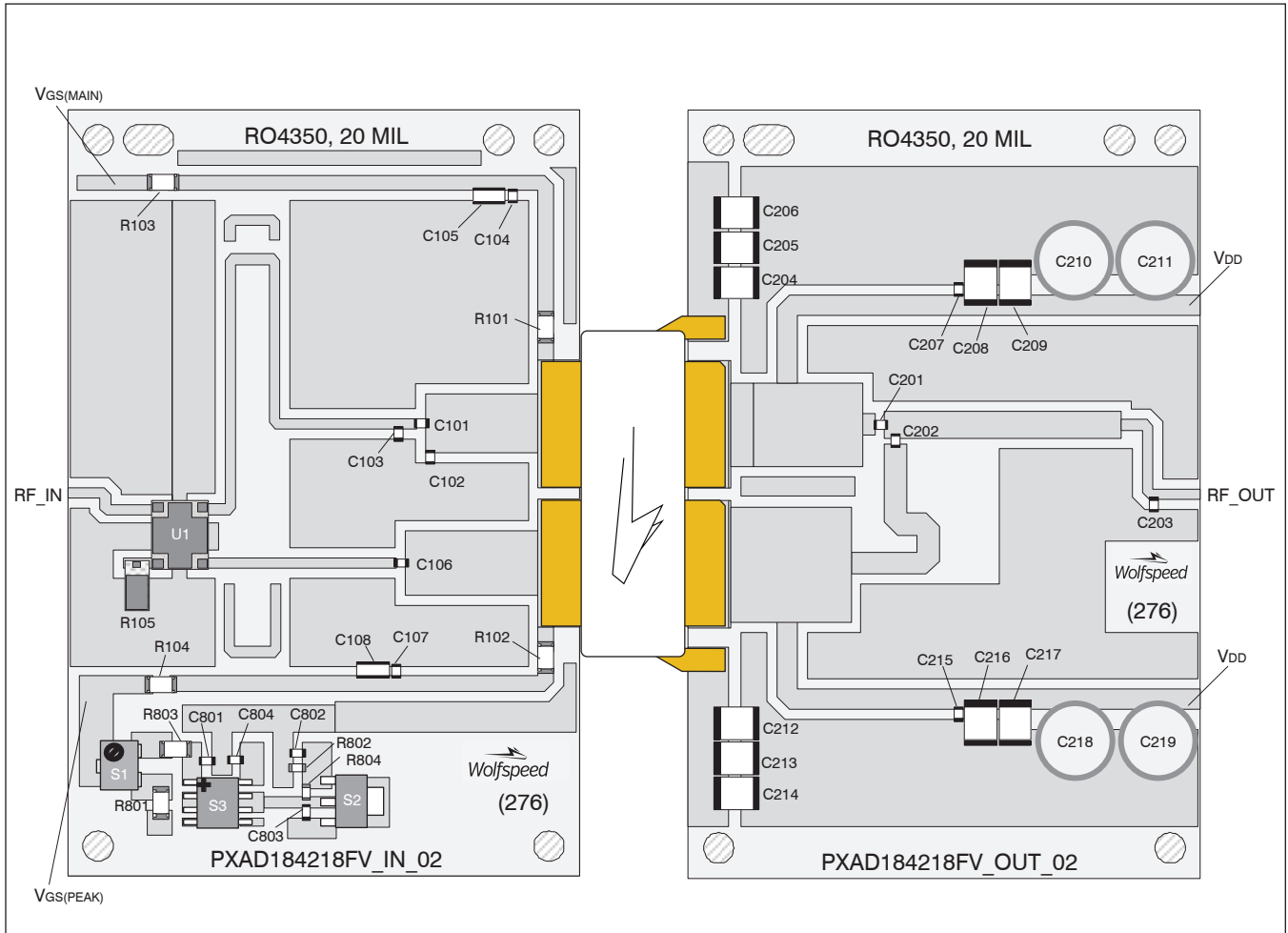

Reference circuit assembly diagram (not to scale)

**Reference Circuit** (cont.)**Reference Circuit Assembly**

DUT	PXAD184218FV V1
Test Fixture Part No.	LTA/PXAD184218FV V1
PCB	Rogers 4350, 0.508 mm [0.020"] thick, 2 oz. copper, $\epsilon_r = 3.66$ , $f = 1805 - 1880$ MHz
Find Gerber files for this test fixture on the Wolfspeed Web site at <a href="http://www.wolfspeed.com/RF">http://www.wolfspeed.com/RF</a>	

**Components Information**

Component	Description	Manufacturer	P/N
<b>Input</b>			
C101, C106	Capacitor, 22 pF	ATC	ATC800A220JT250T
C102	Capacitor, 1.8 pF	ATC	ATC800A1R8CT250T
C103	Capacitor, 0.6 pF	ATC	ATC800A0R6CT250T
C104, C107	Capacitor, 33 pF	ATC	ATC800A330JT250T
C105, C108	Capacitor, 10 $\mu$ F	Murata Electronics North America	LLL31MR60J106ME01L
R101, R102, R103, R104	Resistor, 10 ohms	Panasonic Electronic Components	ERJ-8GEYJ100V
R105	Resistor, 50 ohms	Richardson	C16A50Z4
C801, C802, C803, C804	Capacitor, 1000 pF	AVX Corporation	06031C102KAT2A
R801	Resistor, 100 ohms	Panasonic Electronic Components	ERJ-8GEYJ101V
R802	Resistor, Chip 1.3K ohms	Panasonic Electronic Components	ERJ-3GEYJ132V
R803	Resistor, 10 ohms	Panasonic Electronic Components	ERJ-8GEYJ100V
R804	Resistor, CHIP 1.2K ohms	Panasonic Electronic Components	ERJ-3GEYJ122V
S1	Resistor, Variable 2K ohms	Bourns Inc.	3224W-1-202E
S2	Transistor	Diodes Incorporated	BCP5616TA
S3	Voltage Regulator	Texas Instruments	LM78L05ACM
U1	Hybrid Coupler	Anaren	05X3C19P1-05S
<b>Output</b>			
C201	Capacitor, 7.5 pF	ATC	ATC800A7R5JT250T
C202	Capacitor, 33 pF	ATC	ATC800A330JT250T
C203	Capacitor, 0.3 pF	ATC	ATC800A0R3CT250T
C204, C205, C206, C208, C209, C212, C213 C214, C216, C217	Capacitor, 10 $\mu$ F	Taiyo Yuden	UMK325C7106MM-T
C207, C215	Capacitor, 22 pF	ATC	ATC800A220JT250T
C210, C211, C218, C219	Capacitor, 220 $\mu$ F	Panasonic Electronic Components	PCE4444TR-ND



**Pinout Diagram** (top view)

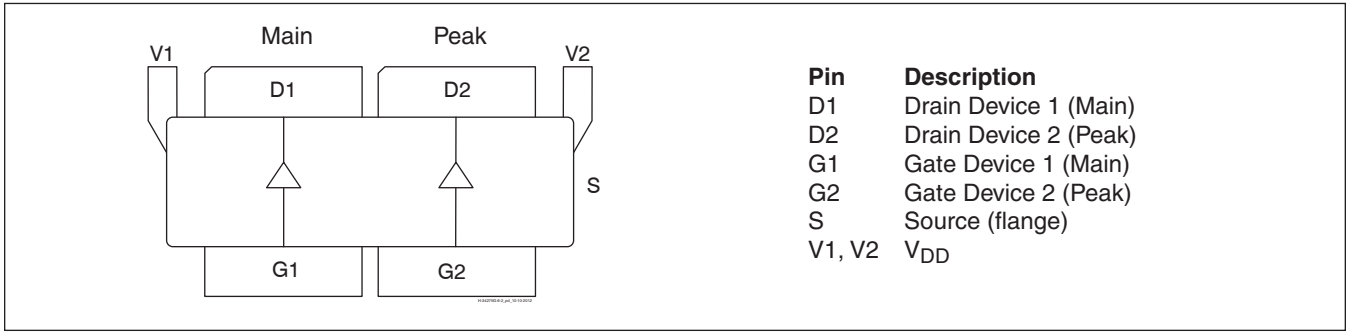

Package Outline Specifications

Package H-37275G-6/2

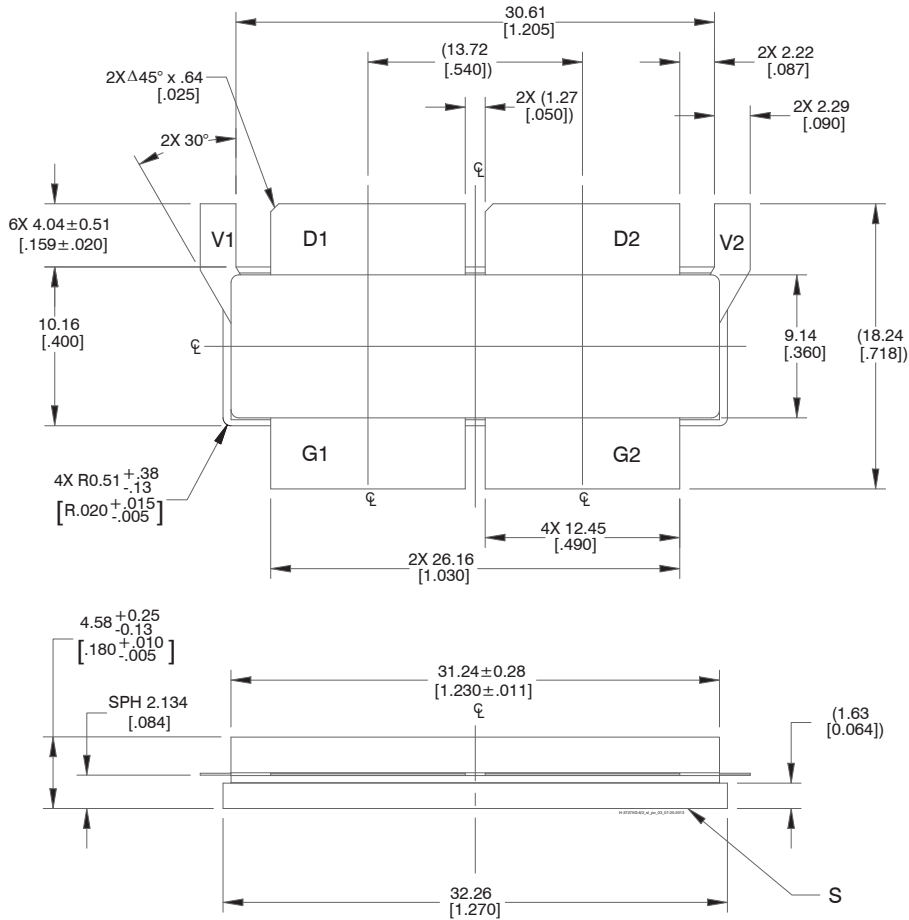

Diagram Notes—unless otherwise specified:

1. Interpret dimensions and tolerances per ASME Y14.5M-1994.
2. Primary dimensions are mm. Alternate dimensions are inches.
3. All tolerances  $\pm 0.127$  [.005] unless specified otherwise.
4. Pins: D1, D2 – drains; G1, G2 – gates; S – source; V1, V2 –  $V_{DD}$ .
5. Lead thickness:  $0.13 + 0.051/-0.025$  mm [0.005+0.002/-0.001 inch].
6. Gold plating thickness:  $1.14 \pm 0.38$  micron [ $45 \pm 15$  microinch].



## Revision History

Revision	Date	Data Sheet Type	Page	Subjects (major changes since last revision)
01	2016-04-20	Advance	All	Data Sheet reflects advance specification for product development
02	2016-11-07	Production	All	Data Sheet reflects released product specification
02.1	2016-12-07	Production	1, 4	Revised typo in Features, revised PAE to Drain Eff in Load Pull performance
03	2018-06-25	Production	All	Converted to Wolfspeed Data Sheet

For more information, please contact:

4600 Silicon Drive  
 Durham, North Carolina, USA 27703  
[www.wolfspeed.com/RF](http://www.wolfspeed.com/RF)

Sales Contact  
[RFSales@wolfspeed.com](mailto:RFSales@wolfspeed.com)

RF Product Marketing Contact  
[RFMarketing@wolfspeed.com](mailto:RFMarketing@wolfspeed.com)  
 919.407.7816

## Notes

---

### Disclaimer

Specifications are subject to change without notice. Cree, Inc. believes the information contained within this data sheet to be accurate and reliable. However, no responsibility is assumed by Cree for any infringement of patents or other rights of third parties which may result from its use. No license is granted by implication or otherwise under any patent or patent rights of Cree. Cree makes no warranty, representation or guarantee regarding the suitability of its products for any particular purpose. "Typical" parameters are the average values expected by Cree in large quantities and are provided for information purposes only. These values can and do vary in different applications and actual performance can vary over time. All operating parameters should be validated by customer's technical experts for each application. Cree products are not designed, intended or authorized for use as components in applications intended for surgical implant into the body or to support or sustain life, in applications in which the failure of the Cree product could result in personal injury or death or in applications for planning, construction, maintenance or direct operation of a nuclear facility.

Компания «Океан Электроники» предлагает заключение долгосрочных отношений при поставках импортных электронных компонентов на взаимовыгодных условиях!

Наши преимущества:

- Поставка оригинальных импортных электронных компонентов напрямую с производств Америки, Европы и Азии, а так же с крупнейших складов мира;
- Широкая линейка поставок активных и пассивных импортных электронных компонентов (более 30 млн. наименований);
- Поставка сложных, дефицитных, либо снятых с производства позиций;
- Оперативные сроки поставки под заказ (от 5 рабочих дней);
- Экспресс доставка в любую точку России;
- Помощь Конструкторского Отдела и консультации квалифицированных инженеров;
- Техническая поддержка проекта, помощь в подборе аналогов, поставка прототипов;
- Поставка электронных компонентов под контролем ВП;
- Система менеджмента качества сертифицирована по Международному стандарту ISO 9001;
- При необходимости вся продукция военного и аэрокосмического назначения проходит испытания и сертификацию в лаборатории (по согласованию с заказчиком);
- Поставка специализированных компонентов военного и аэрокосмического уровня качества (Xilinx, Altera, Analog Devices, Intersil, Interpoint, Microsemi, Actel, Aeroflex, Peregrine, VPT, Syfer, Eurofarad, Texas Instruments, MS Kennedy, Miteq, Cobham, E2V, MA-COM, Hittite, Mini-Circuits, General Dynamics и др.);

Компания «Океан Электроники» является официальным дистрибьютором и эксклюзивным представителем в России одного из крупнейших производителей разъемов военного и аэрокосмического назначения «JONHON», а так же официальным дистрибьютором и эксклюзивным представителем в России производителя высокотехнологичных и надежных решений для передачи СВЧ сигналов «FORSTAR».



## JONHON

«JONHON» (основан в 1970 г.)

Разъемы специального, военного и аэрокосмического назначения:

(Применяются в военной, авиационной, аэрокосмической, морской, железнодорожной, горно- и нефтедобывающей отраслях промышленности)

«FORSTAR» (основан в 1998 г.)

ВЧ соединители, коаксиальные кабели,  
кабельные сборки и микроволновые компоненты:

(Применяются в телекоммуникациях гражданского и специального назначения, в средствах связи, РЛС, а так же военной, авиационной и аэрокосмической отраслях промышленности).



Телефон: 8 (812) 309-75-97 (многоканальный)

Факс: 8 (812) 320-03-32

Электронная почта: [ocean@oceanchips.ru](mailto:ocean@oceanchips.ru)

Web: <http://oceanchips.ru/>

Адрес: 198099, г. Санкт-Петербург, ул. Калинина, д. 2, корп. 4, лит. А