



# Low-Voltage, CMOS Analog Multiplexers/Switches

MAX4581/MAX4582/MAX4583

## General Description

The MAX4581/MAX4582/MAX4583 are low-voltage, CMOS analog ICs configured as an 8-channel multiplexer (MAX4581), two 4-channel multiplexers (MAX4582), and three single-pole/double-throw (SPDT) switches (MAX4583).

These CMOS devices can operate continuously with  $\pm 2V$  to  $\pm 6V$  dual power supplies or a  $+2V$  to  $+12V$  single supply. Each switch can handle rail-to-rail analog signals. The off-leakage current is only  $1nA$  at  $+25^\circ C$  or  $5nA$  at  $+85^\circ C$ .

All digital inputs have  $0.8V$  to  $2.4V$  logic thresholds, ensuring TTL/CMOS-logic compatibility when using a single  $+5V$  or dual  $\pm 5V$  supplies.

## Applications

- Battery-Operated Equipment
- Audio and Video Signal Routing
- Low-Voltage Data-Acquisition Systems
- Communications Circuits
- Automotive

## Features

- ◆ MAX4582 Available in AEC-Q100 Qualified Version
- ◆ Offered in Automotive Temperature Range ( $-40^\circ C$  to  $+125^\circ C$ )
- ◆ Guaranteed On-Resistance  
80 $\Omega$  with  $\pm 5V$  Supplies  
150 $\Omega$  with Single  $+5V$  Supply
- ◆ Guaranteed On-Resistance Match Between Channels
- ◆ Guaranteed Low Off-Leakage Current  
1nA at  $+25^\circ C$
- ◆ Guaranteed Low On-Leakage Current  
1nA at  $+25^\circ C$
- ◆  $+2V$  to  $+12V$  Single-Supply Operation  
 $\pm 2V$  to  $\pm 6V$  Dual-Supply Operation
- ◆ TTL/CMOS-Logic Compatible
- ◆ Low Distortion:  $< 0.02\%$  (600 $\Omega$ )
- ◆ Low Crosstalk:  $< -96dB$  (50 $\Omega$ , MAX4582)
- ◆ High Off-Isolation:  $< -74dB$  (50 $\Omega$ )

## Ordering Information

PART	TEMP RANGE	PIN-PACKAGE	TOP MARK
MAX4581CPE+	$0^\circ C$ to $+70^\circ C$	16 PDIP	—
MAX4581CSE+	$0^\circ C$ to $+70^\circ C$	16 Narrow SO	—
MAX4581CUE+	$0^\circ C$ to $+70^\circ C$	16 TSSOP	—

+Denotes a lead(Pb)-free/RoHS-compliant package.

Ordering Information continued at end of data sheet.

## Pin Configurations/Functional Diagrams



# Low-Voltage, CMOS Analog Multiplexers/Switches

## ABSOLUTE MAXIMUM RATINGS

Voltages Referenced to V<sub>EE</sub>

V <sub>CC</sub> .....	-0.3V to 13V
Voltage into Any Terminal (Note 1) ... (V <sub>EE</sub> - 0.3V) to (V <sub>CC</sub> + 0.3V)	
Continuous Current into Any Terminal.....	±20mA
Peak Current, X <sub>-</sub> , Y <sub>-</sub> , Z <sub>-</sub> (pulsed at 1ms, 10% duty cycle).....	±40mA
ESD per Method 3015.7 .....	>2000V
Continuous Power Dissipation (T <sub>A</sub> = +70°C)	
16-Pin PDIP (derate 10.53mW/°C above +70°C).....	842mW
16-Pin Narrow SO (derate 8.70mW/°C above +70°C) .....	696mW

16-Pin QSOP (derate 8.3mW/°C above +70°C).....	667mW
16-Pin TSSOP (derate 9.4mW/°C above +70°C) .....	755mW
16-Pin TQFN (derate 14.7mW/°C above +70°C) .....	1177mW
Operating Temperature Ranges	
MAX458_C_ .....	0°C to +70°C
MAX458_E_ .....	-40°C to +85°C
MAX458_A_.....	-40°C to +125°C
Storage Temperature Range .....	-65°C to +150°C
Lead Temperature (soldering, 10s) .....	+300°C
Soldering Temperature (reflow) .....	+260°C

**Note 1:** Voltages exceeding V<sub>CC</sub> or V<sub>EE</sub> on any signal terminal are clamped by internal diodes. Limit forward-diode current to maximum current rating.

Stresses beyond those listed under "Absolute Maximum Ratings" may cause permanent damage to the device. These are stress ratings only, and functional operation of the device at these or any other conditions beyond those indicated in the operational sections of the specifications is not implied. Exposure to absolute maximum rating conditions for extended periods may affect device reliability.

## ELECTRICAL CHARACTERISTICS—Dual Supplies

(V<sub>CC</sub> = 4.5V to 5.5V, V<sub>EE</sub> = -4.5V to -5.5V, V<sub>H</sub> = 2.4V, V<sub>L</sub> = 0.8V, T<sub>A</sub> = T<sub>MIN</sub> to T<sub>MAX</sub>, unless otherwise noted. Typical values are at T<sub>A</sub> = +25°C.)

PARAMETER	SYMBOL	CONDITIONS	TEMP	MIN	TYP (Note 2)	MAX	UNITS
<b>ANALOG SWITCH</b>							
Analog-Signal Range	V <sub>X</sub> , V <sub>Y</sub> , V <sub>Z</sub>		C, E, A	V <sub>EE</sub>		V <sub>CC</sub>	V
Switch On-Resistance	R <sub>ON</sub>	V <sub>CC</sub> = 4.5V; V <sub>EE</sub> = -4.5V; I <sub>X</sub> , I <sub>Y</sub> , I <sub>Z</sub> = 1mA; V <sub>X</sub> , V <sub>Y</sub> , V <sub>Z</sub> = 3.5V	+25°C		50	80	Ω
			C, E, A			100	
Switch On-Resistance Match Between Channels (Note 3)	ΔR <sub>ON</sub>	V <sub>CC</sub> = 4.5V; V <sub>EE</sub> = -4.5V; I <sub>X</sub> , I <sub>Y</sub> , I <sub>Z</sub> = 1mA; V <sub>X</sub> , V <sub>Y</sub> , V <sub>Z</sub> = 3.5V	+25°C		1	4	Ω
			C, E, A			6	
Switch On-Resistance Flatness (Note 4)	R <sub>FLAT(ON)</sub>	V <sub>CC</sub> = 5V; V <sub>EE</sub> = -5V; I <sub>X</sub> , I <sub>Y</sub> , I <sub>Z</sub> = 1mA; V <sub>X</sub> , V <sub>Y</sub> , V <sub>Z</sub> = 3V, 0V, -3V	+25°C		4	10	Ω
			C, E, A			12	
X <sub>-</sub> , Y <sub>-</sub> , Z <sub>-</sub> Off-Leakage (Note 5)	I <sub>X(OFF)</sub> , I <sub>Y(OFF)</sub> , I <sub>Z(OFF)</sub>	V <sub>CC</sub> = 5.5V; V <sub>EE</sub> = -5.5V; V <sub>X-</sub> , V <sub>Y-</sub> , V <sub>Z-</sub> = ±4.5V; V <sub>X</sub> , V <sub>Y</sub> , V <sub>Z</sub> = ∓4.5V	+25°C	-1		+1	nA
			C, E, A	-10		+10	
X, Y, Z Off-Leakage (Note 5)	I <sub>X(OFF)</sub> , I <sub>Y(OFF)</sub> , I <sub>Z(OFF)</sub>	V <sub>CC</sub> = 5.5V; V <sub>EE</sub> = -5.5V; V <sub>X-</sub> , V <sub>Y-</sub> , V <sub>Z-</sub> = ±4.5V; V <sub>X</sub> , V <sub>Y</sub> , V <sub>Z</sub> = ∓4.5V	MAX4581	+25°C	-2	+2	nA
			MAX4582 MAX4583	C, E, A	-100	+100	
				+25°C	-1	+1	
X, Y, Z On-Leakage (Note 5)	I <sub>X(ON)</sub> , I <sub>Y(ON)</sub> , I <sub>Z(ON)</sub>	V <sub>CC</sub> = 5.5V; V <sub>EE</sub> = -5.5V; V <sub>X</sub> , V <sub>Y</sub> , V <sub>Z</sub> = ±4.5V	MAX4581	+25°C	-2	+2	nA
			MAX4582 MAX4583	C, E, A	-100	+100	
				+25°C	-1	+1	
X, Y, Z On-Leakage (Note 5)	I <sub>X(ON)</sub> , I <sub>Y(ON)</sub> , I <sub>Z(ON)</sub>	V <sub>CC</sub> = 5.5V; V <sub>EE</sub> = -5.5V; V <sub>X</sub> , V <sub>Y</sub> , V <sub>Z</sub> = ±4.5V	MAX4581	+25°C	-2	+2	nA
			MAX4582 MAX4583	C, E, A	-100	+100	
				+25°C	-1	+1	
<b>DIGITAL I/O</b>							
Logic Input Logic Threshold High	V <sub>AH</sub> , V <sub>BH</sub> , V <sub>CH</sub>		C, E, A		1.5	2.4	V
Logic Input Logic Threshold Low	V <sub>AL</sub> , V <sub>BL</sub> , V <sub>CL</sub>		C, E, A	0.8	1.5		V

# Low-Voltage, CMOS Analog Multiplexers/Switches

MAX4581/MAX4582/MAX4583

## ELECTRICAL CHARACTERISTICS—Dual Supplies (continued)

( $V_{CC} = 4.5V$  to  $5.5V$ ,  $V_{EE} = -4.5V$  to  $-5.5V$ ,  $V_{_H} = 2.4V$ ,  $V_{_L} = 0.8V$ ,  $T_A = T_{MIN}$  to  $T_{MAX}$ , unless otherwise noted. Typical values are at  $T_A = +25^{\circ}C$ .)

PARAMETER	SYMBOL	CONDITIONS	TEMP	MIN	TYP (Note 2)	MAX	UNITS
Input-Current High	$I_{AH}$ , $I_{BH}$ , $I_{CH}$	$V_A, V_B, V_C = 2.4V$	C, E, A	-1		+1	$\mu A$
Input-Current Low	$I_{AL}$ , $I_{BL}$ , $I_{CL}$	$V_A, V_B, V_C = 0.8V$	C, E, A	-1		+1	$\mu A$
<b>SWITCH DYNAMIC CHARACTERISTICS</b>							
Inhibit Turn-On Time	$t_{(ON)}$	$V_{X\_}, V_{Y\_}, V_{Z\_} = 3V$ ; $R_L = 300\Omega$ ; $C_L = 35pF$ ; Figure 3	$T_A = +25^{\circ}C$ C, E, A		100	200	ns
Inhibit Turn-Off Time	$t_{(OFF)}$	$V_{X\_}, V_{Y\_}, V_{Z\_} = 3V$ ; $R_L = 300\Omega$ ; $C_L = 35pF$ ; Figure 3	$T_A = +25^{\circ}C$ C, E, A		40	100	ns
Address Transition Time	$t_{TRANS}$	$V_{X\_}, V_{Y\_}, V_{Z\_} = \pm 3V$ ; $R_L = 300\Omega$ ; $C_L = 35pF$ ; Figure 2	$T_A = +25^{\circ}C$ C, E, A		90	200	ns
Break-Before-Make Time	$t_{BBM}$	$V_{X\_}, V_{Y\_}, V_{Z\_} = 3V$ ; $R_L = 300\Omega$ ; $C_L = 35pF$ ; Figure 4	$T_A = +25^{\circ}C$	4	20		ns
Charge Injection (Note 6)	Q	$C = 1nF$ , $R_S = 0\Omega$ , $V_S = 0V$	$T_A = +25^{\circ}C$		0.5	5	pC
Input Off-Capacitance	$C_{X(OFF)}$ , $C_{Y(OFF)}$ , $C_{Z(OFF)}$	$V_{X\_}, V_{Y\_}, V_{Z\_} = 0V$ ; $f = 1MHz$ ; Figure 7	$T_A = +25^{\circ}C$		4		pF
Output Off-Capacitance	$C_{X(OFF)}$ , $C_{Y(OFF)}$ , $C_{Z(OFF)}$	$V_{X\_}, V_{Y\_}, V_{Z\_} = 0V$ ; $f = 1MHz$ ; Figure 7	$T_A = +25^{\circ}C$			18 10 6	pF
Output On-Capacitance	$C_{X(ON)}$ , $C_{Y(ON)}$ , $C_{Z(ON)}$	$V_{X\_}, V_{Y\_}, V_{Z\_} = 0V$ ; $f = 1MHz$ ; Figure 7	$T_A = +25^{\circ}C$			25 17 12.5	pF
Off-Isolation	$V_{ISO}$	$R_L = 50\Omega$ , $f = 1MHz$ , Figure 6	$T_A = +25^{\circ}C$		-74		dB
Channel-to-Channel Crosstalk	$V_{CT}$	$R_L = 50\Omega$ , $f = 1MHz$ , Figure 6	$T_A = +25^{\circ}C$ $T_A = +25^{\circ}C$ $T_A = +25^{\circ}C$		-78 -96 -73		dB pF
Total Harmonic Distortion	THD	$R_L = 600\Omega$ , $5Vp-p$ , $f = 20Hz$ to $20kHz$	$T_A = +25^{\circ}C$		0.02		%
<b>POWER SUPPLY</b>							
Power-Supply Range	$V_{CC}$ , $V_{EE}$		C, E, A	$\pm 2$		$\pm 6$	V
Power-Supply Current	$I_{CC}$ , $I_{EE}$	$V_{CC} = 5.5V$ , $V_{EE} = -5.5V$ , $V_A, V_B, V_C, V_{Enable} = V+$ or $0V$	$T_A = +25^{\circ}C$ C, E, A	-1 -10		+1 +10	$\mu A$

# Low-Voltage, CMOS Analog Multiplexers/Switches

## ELECTRICAL CHARACTERISTICS—Single +5V Supply

( $V_{CC} = 4.5V$  to  $5.5V$ ,  $V_{EE} = 0V$ ,  $V_{H} = 2.4V$ ,  $V_{L} = 0.8V$ ,  $T_A = T_{MIN}$  to  $T_{MAX}$ , unless otherwise noted. Typical values are at  $T_A = +25^{\circ}C$ .)

PARAMETER	SYMBOL	CONDITIONS	TEMP	MIN	TYP (Note 2)	MAX	UNITS
<b>ANALOG SWITCH</b>							
Analog-Signal Range	$V_{X-}, V_{Y-}, V_{Z-},$ $V_X, V_Y, V_Z$		C, E, A	$V_{EE}$		$V_{CC}$	V
Switch On-Resistance	$R_{ON}$	$V_{CC} = 4.5V$ ; $I_X, I_Y, I_Z = 1mA$ ; $V_X, V_Y, V_Z = 3.5V$	$T_A = +25^{\circ}C$ C, E, A		90	150 200	$\Omega$
Switch On-Resistance Match Between Channels (Note 3)	$\Delta R_{ON}$	$V_{CC} = 4.5V$ ; $I_X, I_Y, I_Z = 1mA$ ; $V_X, V_Y, V_Z = 3.5V$	$T_A = +25^{\circ}C$ C, E, A		2	8 10	$\Omega$
X <sub>-</sub> , Y <sub>-</sub> , Z Off-Leakage (Note 5)	$I_{X(OFF)},$ $I_{Y(OFF)},$ $I_{Z(OFF)}$	$V_{CC} = 5.5V$ ; $V_{X-}, V_{Y-}, V_{Z-} = 1V, 4.5V$ ; $V_X, V_Y, V_Z = 4.5V, 1V$	$T_A = +25^{\circ}C$ C, E, A	-1		+1 +10	nA
X, Y, Z Off-Leakage (Note 5)	$I_{X(OFF)},$ $I_{Y(OFF)},$ $I_{Z(OFF)}$	$V_{CC} = 5.5V$ ; $V_{X-}, V_{Y-}, V_{Z-} = 1V, 4.5V$ ; $V_X, V_Y, V_Z = 4.5V, 1V$	MAX4581	$T_A = +25^{\circ}C$ C, E, A	-2	+2 +100	nA
			MAX4582 MAX4583	$T_A = +25^{\circ}C$ C, E, A	-1	+1 +50	
X, Y, Z On-Leakage (Note 5)	$I_{X(ON)},$ $I_{Y(ON)},$ $I_{Z(ON)}$	$V_{CC} = 5.5V$ ; $V_X, V_Y, V_Z = 4.5V, 1V$	MAX4581	$T_A = +25^{\circ}C$ C, E, A	-2	+2 +100	nA
			MAX4582	$T_A = +25^{\circ}C$	-1	+1	
			MAX4583	C, E, A	-50	+50	
<b>DIGITAL I/O</b>							
Logic Input Logic Threshold High	$V_{AH}, V_{BH}, V_{CH},$ $V_{ENABLEH}$		C, E, A		1.5	2.4	V
Logic Input Logic Threshold Low	$V_{AL}, V_{BL}, V_{CL},$ $V_{ENABLEL}$		C, E, A	0.8	1.5		V
Input-Current High	$I_{AH}, I_{BH}, I_{CH},$ $I_{ENABLEH}$	$V_{AL}, V_{BL}, V_{CL}, V_{ENABLEL} = 2.4V$	C, E, A	-1		+1	$\mu A$
Input-Current Low	$I_{AL}, I_{BL}, I_{CL},$ $I_{ENABLEL}$	$V_{AL}, V_{BL}, V_{CL}, V_{ENABLEL} = 0.8V$	C, E, A	-1		+1	$\mu A$
<b>SWITCH DYNAMIC CHARACTERISTICS</b>							
Charge Injection (Note 6)	Q	$C = 1nF, R_S = 0\Omega, V_S = 2.5V$	$T_A = +25^{\circ}C$		0.8	5	pC
Enable Turn-On Time	$t_{(ON)}$	$V_{X-}, V_{Y-}, V_{Z-} = 3V, R_L = 300\Omega, C_L = 35pF,$ Figure 3	$T_A = +25^{\circ}C$		100	200	ns
			C, E, A			250	
Enable Turn-Off Time	$t_{(OFF)}$	$V_{X-}, V_{Y-}, V_{Z-} = 3V, R_L = 300\Omega, C_L = 35pF,$ Figure 3	$T_A = +25^{\circ}C$		40	100	ns
			C, E, A			150	
Address Transition Time	$t_{TRANS}$	$V_{X-}, V_{Y-}, V_{Z-} = 3V/0V, R_L = 300\Omega,$ $C_L = 35pF,$ Figure 2	$T_A = +25^{\circ}C$		80	200	ns
			C, E, A			250	
Break-Before-Make Time	$t_{BBM}$	$V_{X-}, V_{Y-}, V_{Z-} = 3V, R_L = 300\Omega, C_L = 35pF,$ Figure 4	$T_A = +25^{\circ}C$	10	30		ns
<b>POWER SUPPLY</b>							
Power-Supply Range	$V_{CC}, V_{EE}$		C, E, A	2		12	V
Power-Supply Current	$I_{CC}, I_{EE}$	$V_{CC} = 3.6V$ ; $V_A, V_B, V_C, V_{ENABLE} = V+ \text{ or } 0V$	$T_A = +25^{\circ}C$	-1		+1	$\mu A$
			C, E, A	-10		+10	

# Low-Voltage, CMOS Analog Multiplexers/Switches

MAX4581/MAX4582/MAX4583

## ELECTRICAL CHARACTERISTICS—Single +3V Supply

( $V_{CC} = 2.7V$  to  $3.6V$ ,  $V_{EE} = 0V$ ,  $V_{LH} = 2.0V$ ,  $V_{LL} = 0.5V$ ,  $T_A = T_{MIN}$  to  $T_{MAX}$ , unless otherwise noted. Typical values are at  $T_A = +25^\circ C$ .)

PARAMETER	SYMBOL	CONDITIONS	TEMP	MIN	TYP (Note 2)	MAX	UNITS
<b>ANALOG SWITCH</b>							
Analog-Signal Range	$V_{X-}, V_{Y-}, V_{Z-},$ $V_X, V_Y, V_Z$		C, E, A	$V_{EE}$		$V_{CC}$	V
Switch On-Resistance	$R_{ON}$	$V_{CC} = 2.7V$ ; $I_X, I_Y, I_Z = 0.1mA$ ; $V_X, V_Y, V_Z = 1.5V$	$T_A = +25^\circ C$ C, E, A		190	450 550	$\Omega$
$X_-, Y_-, Z_-$ Off-Leakage (Note 5)	$I_{X(OFF)},$ $I_{Y(OFF)},$ $I_{Z(OFF)}$	$V_{CC} = 3.6V$ ; $V_{X-}, V_{Y-}, V_{Z-} = 1V, 3V$ ; $V_X, V_Y, V_Z = 3V, 1V$	$T_A = +25^\circ C$ C, E, A	-1		+1 +10	nA
$X, Y, Z$ Off-Leakage (Note 6)	$I_X(OFF),$ $I_Y(OFF),$ $I_Z(OFF)$	$V_{CC} = 3.6V$ ; $V_{X-}, V_{Y-}, V_{Z-} = 1V, 3.0V$ ; $V_X, V_Y, V_Z = 3.0V, 1V$	MAX4581	$T_A = +25^\circ C$ C, E, A	-2	+2 +100	nA
			MAX4582	$T_A = +25^\circ C$	-1	+1	
			MAX4583	C, E, A	-50	+50	
$X, Y, Z$ On-Leakage (Note 6)	$I_X(ON),$ $I_Y(ON),$ $I_Z(ON)$	$V_{CC} = 3.6V$ ; $V_X, V_Y, V_Z = 3.0V, 1V$	MAX4581	$T_A = +25^\circ C$ C, E, A	-2	+2 +100	nA
			MAX4582	$T_A = +25^\circ C$	-1	+1	
			MAX4583	C, E, A	-50	+50	
<b>DIGITAL I/O</b>							
Logic Input Logic Threshold High	$V_{AH}, V_{BH}, V_{CH},$ $V_{ENABLEH}$		C, E, A		1.0	2.0	V
Logic Input Logic Threshold Low	$V_{AL}, V_{BL}, V_{CL},$ $V_{ENABLEL}$		C, E, A	0.5	1.0		V
Input-Current High	$I_{AH}, I_{BH}, I_{CH},$ $I_{ENABLEH}$	$V_A, V_B, V_C = V_{ENABLE} = 2.0V$	C, E, A	-1		+1	$\mu A$
Input-Current Low	$I_{AL}, I_{BL}, I_{CL},$ $I_{ENABLEL}$	$V_A, V_B, V_C = V_{ENABLE} = 0.5V$	C, E, A	-1		+1	$\mu A$
<b>SWITCH DYNAMIC CHARACTERISTICS</b> (Note 6)							
Enable Turn-On Time	$t_{(ON)}$	$V_{X-}, V_{Y-}, V_{Z-} = 1.5V$ ; $R_L = 300\Omega$ ; $C_L = 35pF$ ; Figure 3	$T_A = +25^\circ C$ C, E, A		170	300 400	ns
Enable Turn-Off Time	$t_{(OFF)}$	$V_{X-}, V_{Y-}, V_{Z-} = 1.5V$ ; $R_L = 300\Omega$ ; $C_L = 35pF$ ; Figure 3	$T_A = +25^\circ C$ C, E, A		50	200 300	ns
Address Transition Time	$t_{TRANS}$	$V_{X-}, V_{Y-}, V_{Z-} = 1.5V/0V$ ; $R_L = 300\Omega$ ; $C_L = 35pF$ ; Figure 2	$T_A = +25^\circ C$ C, E, A		130	300 400	ns
Break-Before-Make Time	$t_{BBM}$	$V_{X-}, V_{Y-}, V_{Z-} = 1.5V$ ; $R_L = 300\Omega$ ; $C_L = 35pF$	$T_A = +25^\circ C$		15	40	ns
<b>POWER SUPPLY</b>							
Power-Supply Current	$I_{CC}, I_{EE}$	$V_{CC} = 3.6V$ ; $V_A, V_B, V_C, V_{ENABLE} = V^+$ or $0V$	$T_A = +25^\circ C$ C, E, A	-1		+1 +10	$\mu A$

**Note 2:** The algebraic convention is used in this data sheet; the most negative value is shown in the minimum column.

**Note 3:**  $\Delta R_{ON} = R_{ON(MAX)} - R_{ON(MIN)}$ .

**Note 4:** Flatness is defined as the difference between the maximum and minimum value of on-resistance as measured over the specified analog signal ranges; i.e.,  $V_{X-}, V_{Y-}, V_{Z-} = 3V$  to  $0$  and  $0$  to  $-3V$ .

**Note 5:** Leakage parameters are 100% tested at maximum-rated hot operating temperature, and guaranteed by correlation at  $T_A = +25^\circ C$ .

**Note 6:** Guaranteed by design, not production tested.

# Low-Voltage, CMOS Analog Multiplexers/Switches

## Typical Operating Characteristics

( $V_{CC} = 5V$ ,  $V_{EE} = -5V$ ,  $V_{GND} = 0V$ ,  $T_A = +25^\circ C$ , unless otherwise noted.)

**ON-RESISTANCE vs.  $V_X$ ,  $V_Y$ ,  $V_Z$  (DUAL SUPPLIES)**



**ON-RESISTANCE vs.  $V_X$ ,  $V_Y$ ,  $V_Z$  AND TEMPERATURE (DUAL SUPPLIES)**



**ON-RESISTANCE vs.  $V_X$ ,  $V_Y$ ,  $V_Z$  (SINGLE SUPPLY)**



**ON-RESISTANCE vs.  $V_X$ ,  $V_Y$ ,  $V_Z$  AND TEMPERATURE (SINGLE SUPPLY)**

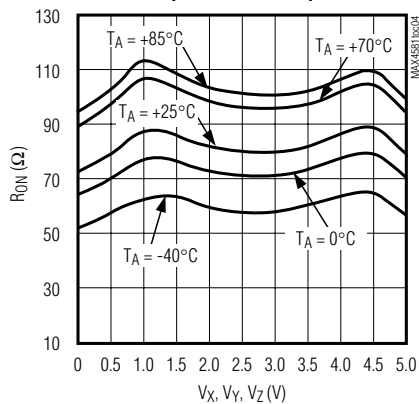

**OFF-LEAKAGE vs. TEMPERATURE**

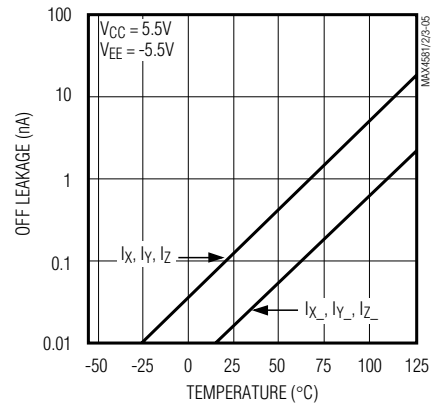

**ON-LEAKAGE vs. TEMPERATURE**



**CHARGE INJECTION vs.  $V_X$ ,  $V_Y$ ,  $V_Z$**



# Low-Voltage, CMOS Analog Multiplexers/Switches

MAX4581/MAX4582/MAX4583

## Typical Operating Characteristics (continued)

( $V_{CC} = 5V$ ,  $V_{EE} = -5V$ ,  $V_{GND} = 0V$ ,  $T_A = +25^\circ C$ , unless otherwise noted.)

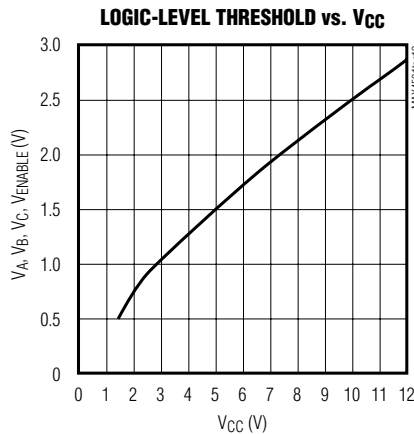
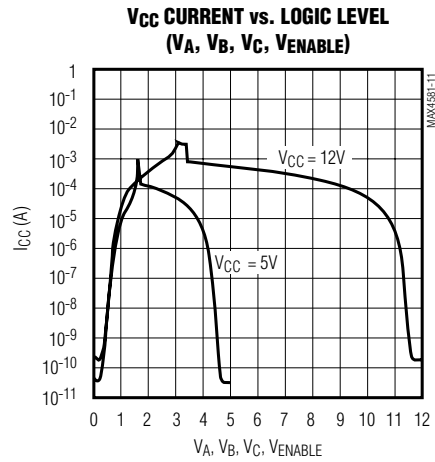
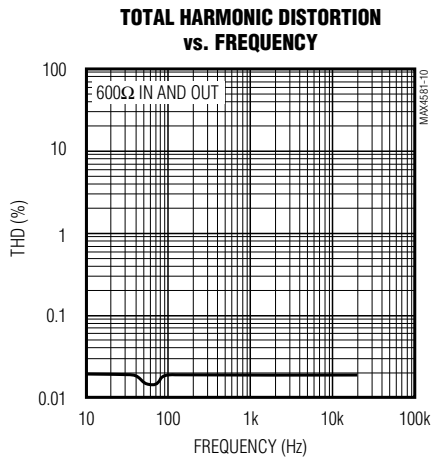
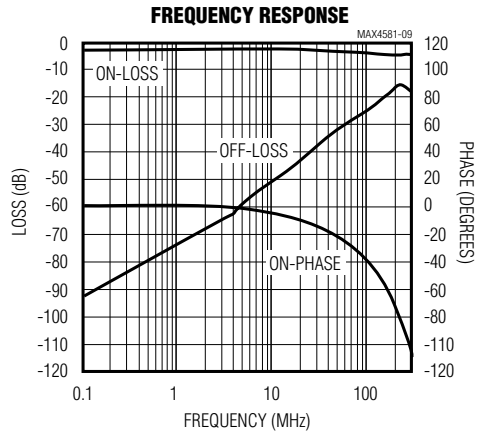

# Low-Voltage, CMOS Analog Multiplexers/Switches

## Pin Description

PIN						NAME	FUNCTION
MAX4581		MAX4582		MAX4583			
PDIP, SO, TSSOP	TQFN-EP	PDIP, SO, TSSOP	TQFN-EP	PDIP, SO, TSSOP	TQFN-EP		
13, 14, 15, 12, 1, 5, 2, 4	11, 12, 13, 10, 15, 3, 16, 2	—	—	—	—	X0–X7	Analog Switch Inputs 0–7
3	1	13	11	14	12	X	Analog Switch “X” Output
—	—	12, 14, 15, 11	10, 12, 13, 9	—	—	X0, X1, X2, X3	Analog Switch “X” Inputs 0–3
—	—	1, 5, 2, 4	15, 3, 16, 2	—	—	Y0, Y1, Y2, Y3	Analog Switch “Y” Inputs 0–3
—	—	3	1	15	13	Y	Analog Switch “Y” Output
—	—	—	—	13	11	X1	Analog Switch “X” Normally Open Input
—	—	—	—	12	10	X0	Analog Switch “X” Normally Closed Input
—	—	—	—	1	15	Y1	Analog Switch “Y” Normally Open Input
—	—	—	—	2	16	Y0	Analog Switch “Y” Normally Open Input
—	—	—	—	3	1	Z1	Analog Switch “Z” Normally Open Input
—	—	—	—	5	3	Z0	Analog Switch “Z” Normally Open Input
—	—	—	—	4	2	Z	Analog Switch “Z” Output
16	14	16	14	16	14	V <sub>CC</sub>	Positive Analog and Digital Supply-Voltage Input
11	9	10	8	11	9	A	Digital Address “A” Input
10	8	9	7	10	8	B	Digital Address “B” Input
9	7	—	—	9	7	C	Digital Address “C” Input
8	6	8	6	8	6	GND	Ground. Connect to digital ground. (Analog signals have no ground reference; they are limited to V <sub>CC</sub> and V <sub>EE</sub> .)
7	5	7	5	7	5	V <sub>EE</sub>	Negative Analog Supply-Voltage Input. Connect to GND for single-supply operation.
6	4	6	4	6	4	ENABLE	Digital Enable Input. Normally connected to GND.
—	—	—	—	—	—	EP	Exposed Pad (TQFN only). Connect EP to V <sub>CC</sub> .

**Note:** Input and output pins are identical and interchangeable. Any may be considered an input or output; signals pass equally well in both directions.

## Applications Information

### Power-Supply Considerations

#### Overview

The MAX4581/MAX4582/MAX4583 construction is typical of most CMOS analog switches. They have three

supply pins: V<sub>CC</sub>, V<sub>EE</sub>, and GND. V<sub>CC</sub> and V<sub>EE</sub> are used to drive the internal CMOS switches and set the limits of the analog voltage on any switch. Reverse ESD-protection diodes are internally connected between each analog-signal pin and both V<sub>CC</sub> and V<sub>EE</sub>. If any analog signal exceeds V<sub>CC</sub> or V<sub>EE</sub>, one of these diodes



# Low-Voltage, CMOS Analog Multiplexers/Switches

MAX4581/MAX4582/MAX4583

**Table 1. Truth Table/Switch Programming**

ENABLE INPUT	SELECT INPUTS			ON SWITCHES		
	C*	B	A	MAX4581	MAX4582	MAX4583
H	X	X	X	All switches open	All switches open	All switches open
L	L	L	L	X-X0	X-X0, Y-Y0	X-X0, Y-Y0, Z-Z0
L	L	L	H	X-X1	X-X1, Y-Y1	X-X1, Y-Y0, Z-Z0
L	L	H	L	X-X2	X-X2, Y-Y2	X-X0, Y-Y1, Z-Z0
L	L	H	H	X-X3	X-X3, Y-Y3	X-X1, Y-Y1, Z-Z0
L	H	L	L	X-X4	X-X0, Y-Y0	X-X0, Y-Y0, Z-Z1
L	H	L	H	X-X5	X-X1, Y-Y1	X-X1, Y-Y0, Z-Z1
L	H	H	L	X-X6	X-X2, Y-Y2	X-X0, Y-Y1, Z-Z1
L	H	H	H	X-X7	X-X3, Y-Y3	X-X1, Y-Y1, Z-Z1

X = Don't care

\*C not present on MAX4582.

**Note:** Input and output pins are identical and interchangeable. Either may be considered an input or output; signals pass equally well in either direction.

will conduct. During normal operation, these and other reverse-biased ESD diodes leak, forming the only current drawn from VCC or VEE.

Virtually all the analog leakage current comes from the ESD diodes. Although the ESD diodes on a given signal pin are identical and therefore fairly well balanced, they are reverse biased differently. Each is biased by either VCC or VEE and the analog signal. This means their leakages will vary as the signal varies. The difference in the two diode leakages to the VCC and VEE pins constitutes the analog-signal-path leakage current. All analog leakage current flows between each pin and one of the supply terminals, not to the other switch terminal. This is why both sides of a given switch can

show leakage currents of either the same or opposite polarity.

There is no connection between the analog-signal paths and GND.

VCC and GND power the internal logic and logic-level translators, and set the input logic limits. The logic-level translators convert the logic levels into switched VCC and VEE signals to drive the gates of the analog signals. This drive signal is the only connection between the logic supplies and signals and the analog supplies. VCC and VEE have ESD-protection diodes to GND.

The logic-level thresholds are TTL/CMOS compatible when VCC is +5V. As VCC rises, the threshold increases

## Low-Voltage, CMOS Analog Multiplexers/Switches

slightly, so when  $V_{CC}$  reaches +12V the threshold is about 3.1V (above the TTL-guaranteed high-level minimum of 2.8V, but still compatible with CMOS outputs).

### Bipolar Supplies

These devices operate with bipolar supplies between  $\pm 2V$  and  $\pm 5V$ . The  $V_{CC}$  and  $V_{EE}$  supplies need not be symmetrical, but their sum cannot exceed the +13V absolute maximum rating.

### Single Supply

These devices operate from a single supply between +2V and +12V when  $V_{EE}$  is connected to GND. All of the bipolar precautions must be observed. At room temperature, they actually “work” with a single supply near or below +1.7V, although as supply voltage decreases, switch on-resistance and switching times become very high.

### Overvoltage Protection

Proper power-supply sequencing is recommended for all CMOS devices. Do not exceed the absolute maximum ratings because stresses beyond the listed ratings can cause permanent damage to the devices. Always sequence  $V_{CC}$  on first, then  $V_{EE}$ , followed by the logic inputs and analog signals. If power-supply sequencing is not possible, add two small signal diodes (D1, D2) in series with the supply pins for overvoltage protection (Figure 1).

Adding diodes reduces the analog-signal range to one diode drop below  $V_{CC}$  and one diode drop above  $V_{EE}$ , but does not affect the devices' low switch resistance and low leakage characteristics. Device operation is unchanged, and the difference between  $V_{CC}$  and  $V_{EE}$  should not exceed 13V. These protection diodes are not recommended when using a single supply if signal levels must extend to ground.

### High-Frequency Performance

In  $50\Omega$  systems, signal response is reasonably flat up to 50MHz (see *Typical Operating Characteristics*). Above 20MHz, the on response has several minor peaks which are highly layout dependent. The problem is not turning the switch on, but turning it off. The off-state switch acts like a capacitor and passes higher frequencies with less attenuation. At 10MHz, off isolation is about -50dB in  $50\Omega$  systems, becoming worse (approximately 20dB per decade) as frequency increases. Higher circuit impedances also degrade off isolation. Adjacent channel attenuation is about 3dB above that of a bare IC socket and is entirely due to capacitive coupling.



Figure 1. Overvoltage Protection Using External Blocking Diodes

### Pin Nomenclature

The MAX4581/MAX4582/MAX4583 are pin-compatible with the industry-standard 74HC4051/74HC4052/74HC4053 and the MAX4051/MAX4052/MAX4053. They function identically and have identical logic diagrams, although these parts differ electrically.

The pin designations and logic diagrams in this data sheet conform to the original 1972 specifications published by RCA for the CD4051/CD4052/CD4053. These designations differ from the standard Maxim switch and mux designations as found all other Maxim data sheets (including the MAX4051/MAX4052/MAX4053) and may cause confusion. Designers who feel more comfortable with Maxim's standard designations are advised that the pin designations and logic diagrams on the MAX4051/MAX4052/MAX4053 data sheet may be freely applied to the MAX4581/MAX4582/MAX4583.

# Low-Voltage, CMOS Analog Multiplexers/Switches

## Test Circuits/Timing Diagrams

MAX4581/MAX4582/MAX4583



Figure 2. Address Transition Times

# Low-Voltage, CMOS Analog Multiplexers/Switches

## Test Circuits/Timing Diagrams (continued)



Figure 3. Inhibit Switching Times

# Low-Voltage, CMOS Analog Multiplexers/Switches

## Test Circuits/Timing Diagrams (continued)

MAX4581/MAX4582/MAX4583



Figure 4. Break-Before-Make Interval



Figure 5. Charge Injection

# Low-Voltage, CMOS Analog Multiplexers/Switches

## Test Circuits/Timing Diagrams (continued)



Figure 6. Off Isolation, On Loss, and Crosstalk

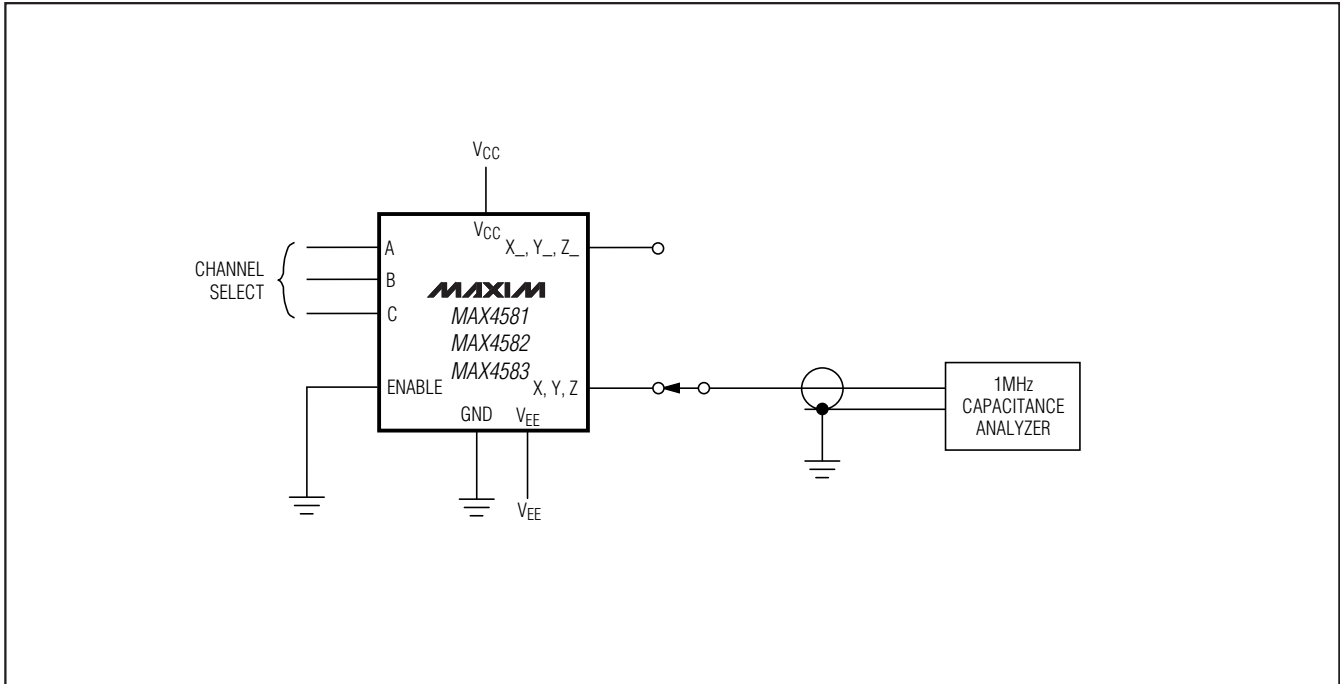

Figure 7. Capacitance

# Low-Voltage, CMOS Analog Multiplexers/Switches

## Pin Configurations/Functional Diagrams (continued)



## Ordering Information (continued)

PART	TEMP RANGE	PIN-PACKAGE	TOP MARK
MAX4581CEE+	0°C to +70°C	16 QSOP	—
MAX4581EPE+	-40°C to +85°C	16 PDIP	—
MAX4581ESE+	-40°C to +85°C	16 Narrow SO	—
MAX4581EUE+	-40°C to +85°C	16 TSSOP	—
MAX4581EEE+	-40°C to +85°C	16 QSOP	—
MAX4581ETE+	-40°C to +85°C	16 TQFN-EP*	AGH
MAX4581ASE+	-40°C to +125°C	16 Narrow SO	—
MAX4581AUE+	-40°C to +125°C	16 TSSOP	—
<b>MAX4582CPE+</b>	0°C to +70°C	16 PDIP	—
MAX4582CSE+	0°C to +70°C	16 Narrow SO	—
MAX4582CUE+	0°C to +70°C	16 TSSOP	—
MAX4582CEE+	0°C to +70°C	16 QSOP	—
MAX4582EPE+	-40°C to +85°C	16 PDIP	—
MAX4582ESE+	-40°C to +85°C	16 Narrow SO	—
MAX4582EUE+	-40°C to +85°C	16 TSSOP	—

PART	TEMP RANGE	PIN-PACKAGE	TOP MARK
MAX4582EEE+	-40°C to +85°C	16 QSOP	—
MAX4582ETE+	-40°C to +85°C	16 TQFN-EP*	AGH
MAX4582ASE+	-40°C to +125°C	16 Narrow SO	—
MAX4582AUE/V+T	-40°C to +125°C	16 TSSOP	—
<b>MAX4583CPE+</b>	0°C to +70°C	16 PDIP	—
MAX4583CSE+	0°C to +70°C	16 Narrow SO	—
MAX4583CUE+	0°C to +70°C	16 TSSOP	—
MAX4583CEE+	0°C to +70°C	16 QSOP	—
MAX4583EPE+	-40°C to +85°C	16 PDIP	—
MAX4583ESE+	-40°C to +85°C	16 Narrow SO	—
MAX4583EUE+	-40°C to +85°C	16 TSSOP	—
MAX4583EEE+	-40°C to +85°C	16 QSOP	—
MAX4583ETE+	-40°C to +85°C	16 TQFN-EP*	AGH
MAX4583ASE+	-40°C to +125°C	16 Narrow SO	—
MAX4583AUE+	-40°C to +125°C	16 TSSOP	—

+Denotes a lead(Pb)-free/RoHS-compliant package.

*N* Denotes an automotive qualified part.

T = Tape and reel.

\*EP = Exposed pad.

# Low-Voltage, CMOS Analog Multiplexers/Switches

## Chip Information

PROCESS: BICMOS

TRANSISTOR COUNT: 219

## Package Information

For the latest package outline information and land patterns (footprints), go to [www.maxim-ic.com/packages](http://www.maxim-ic.com/packages). Note that a "+", "#", or "-" in the package code indicates RoHS status only. Package drawings may show a different suffix character, but the drawing pertains to the package regardless of RoHS status.

PACKAGE TYPE	PACKAGE CODE	OUTLINE NO.	LAND PATTERN NO.
16 PDIP	P16+1	<a href="#">21-0043</a>	—
16 Narrow SO	S16+1	<a href="#">21-0041</a>	<a href="#">90-0097</a>
16 TSSOP	U16+2	<a href="#">21-0066</a>	<a href="#">90-0117</a>
16 QSOP	E16+4	<a href="#">21-0055</a>	<a href="#">90-0167</a>
16 TQFN	T1633+5	<a href="#">21-0136</a>	<a href="#">90-0032</a>



# Low-Voltage, CMOS Analog Multiplexers/Switches

## Revision History

REVISION NUMBER	REVISION DATE	DESCRIPTION	PAGES CHANGED
5	6/07	Various changes	—
6	3/12	Updated TQFN, PDIP, and lead-free packaging options; updated temperature ranges	1-7, 15, 16

MAX4581/MAX4582/MAX4583

Maxim cannot assume responsibility for use of any circuitry other than circuitry entirely embodied in a Maxim product. No circuit patent licenses are implied. Maxim reserves the right to change the circuitry and specifications without notice at any time. The parametric values (min and max limits) shown in the Electrical Characteristics table are guaranteed. Other parametric values quoted in this data sheet are provided for guidance.

17 **Maxim Integrated Products, 120 San Gabriel Drive, Sunnyvale, CA 94086 408-737-7600**

Компания «Океан Электроники» предлагает заключение долгосрочных отношений при поставках импортных электронных компонентов на взаимовыгодных условиях!

Наши преимущества:

- Поставка оригинальных импортных электронных компонентов напрямую с производств Америки, Европы и Азии, а так же с крупнейших складов мира;
- Широкая линейка поставок активных и пассивных импортных электронных компонентов (более 30 млн. наименований);
- Поставка сложных, дефицитных, либо снятых с производства позиций;
- Оперативные сроки поставки под заказ (от 5 рабочих дней);
- Экспресс доставка в любую точку России;
- Помощь Конструкторского Отдела и консультации квалифицированных инженеров;
- Техническая поддержка проекта, помощь в подборе аналогов, поставка прототипов;
- Поставка электронных компонентов под контролем ВП;
- Система менеджмента качества сертифицирована по Международному стандарту ISO 9001;
- При необходимости вся продукция военного и аэрокосмического назначения проходит испытания и сертификацию в лаборатории (по согласованию с заказчиком);
- Поставка специализированных компонентов военного и аэрокосмического уровня качества (Xilinx, Altera, Analog Devices, Intersil, Interpoint, Microsemi, Actel, Aeroflex, Peregrine, VPT, Syfer, Eurofarad, Texas Instruments, MS Kennedy, Miteq, Cobham, E2V, MA-COM, Hittite, Mini-Circuits, General Dynamics и др.);

Компания «Океан Электроники» является официальным дистрибьютором и эксклюзивным представителем в России одного из крупнейших производителей разъемов военного и аэрокосмического назначения «JONHON», а так же официальным дистрибьютором и эксклюзивным представителем в России производителя высокотехнологичных и надежных решений для передачи СВЧ сигналов «FORSTAR».



## JONHON

«JONHON» (основан в 1970 г.)

Разъемы специального, военного и аэрокосмического назначения:

(Применяются в военной, авиационной, аэрокосмической, морской, железнодорожной, горно- и нефтедобывающей отраслях промышленности)

«FORSTAR» (основан в 1998 г.)

ВЧ соединители, коаксиальные кабели, кабельные сборки и микроволновые компоненты:

(Применяются в телекоммуникациях гражданского и специального назначения, в средствах связи, РЛС, а так же военной, авиационной и аэрокосмической отраслях промышленности).



Телефон: 8 (812) 309-75-97 (многоканальный)

Факс: 8 (812) 320-03-32

Электронная почта: [ocean@oceanchips.ru](mailto:ocean@oceanchips.ru)

Web: <http://oceanchips.ru/>

Адрес: 198099, г. Санкт-Петербург, ул. Калинина, д. 2, корп. 4, лит. А