

DC Film Capacitors MKT Radial Potted Type

FEATURES

- AEC-Q200 qualified (rev. D) for PCM 10.0 mm up to and including 22.5 mm (further customized components on request)
- High temperature capabilities, up to 150 °C
- Capacitance up to 560 µF
- 4-pin version available under request for pitch ≥ 37.5 mm, under request
- Material categorization: for definitions of compliance please see www.vishay.com/doc?99912

 AUTOMOTIVE
GRADE
Available

RoHS
COMPLIANT

 HALOGEN
FREE
GREEN
(5-2008)

APPLICATIONS

- Automotive
- DC filtering
- Low voltage DC link (48 V bus)
- General purpose

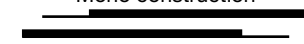
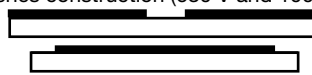
QUICK REFERENCE DATA	
Capacitance range	1000 pF to 560 µF
Capacitance tolerance	$\pm 20\%$, $\pm 10\%$, $\pm 5\%$
Climatic testing class according to IEC 60068-1	55/125/56
Maximum application temperature	125 °C
Reference standards	IEC 60384-2
Dielectric	Polyester film
Electrodes	Metallized
Construction	Mono construction  Series construction (630 V and 1000 V) 
Encapsulation	Plastic case, epoxy resin sealed, flame retardant UL-class 94 V-0
Leads	Tinned wire
Marking	C-value; tolerance; rated voltage; code for dielectric material; code for manufacturing origin; manufacturer's type designation; manufacturer's logo or name; year and week of manufacture
Rated (DC) voltage	63 V _{DC} , 100 V _{DC} , 160 V _{DC} , 250 V _{DC} , 400 V _{DC} , 630 V _{DC} , 1000 V _{DC}
Rated (AC) voltage	40 V _{AC} , 63 V _{AC} , 160 V _{AC} , 200 V _{AC} , 220 V _{AC}
Maximum operating temperature for limited time	150 °C at 0.3 U _R for maximum 200 h (not applicable for pitch ≥ 37.5 mm)

Note

- For more detailed data and test requirements, contact dc-film@vishay.com

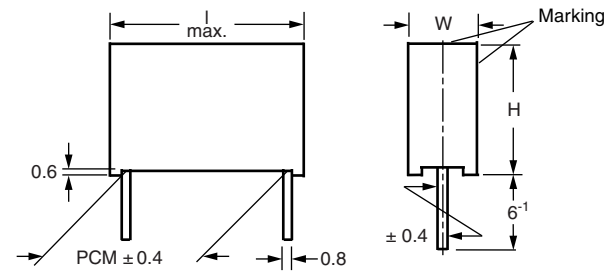
DIMENSIONS in millimeters

COMPOSITION OF CATALOG NUMBER

Notes

- For detailed tape specifications refer to packaging information www.vishay.com/docs?28139 or end of catalog
- For PCM ≥ 37.5 mm, 4 pin versions are available under customer request

SPECIFIC REFERENCE DATA								
DESCRIPTION		VALUE						
Tangent of loss angle:		at 100 Hz	at 1 kHz	at 10 kHz	at 100 kHz			
C $\leq 0.1 \mu$ F		-	$\leq 80 \times 10^{-4}$	$\leq 150 \times 10^{-4}$	$\leq 250 \times 10^{-4}$			
0.1 μ F < C $\leq 1.0 \mu$ F		-	$\leq 80 \times 10^{-4}$	$\leq 150 \times 10^{-4}$	-			
1.0 μ F < C $\leq 10.0 \mu$ F		$\leq 35 \times 10^{-4}$	$\leq 150 \times 10^{-4}$	-	-			
10.0 μ F < C $\leq 100 \mu$ F		$\leq 50 \times 10^{-4}$	$\leq 300 \times 10^{-4}$	-	-			
C > 100 μ F		$\leq 70 \times 10^{-4}$	-	-	-			
PITCH (mm)	MAXIMUM PULSE RISE TIME (dU/dt) _R [V/ μ s]							
	63 V _{DC}	100 V _{DC}	160 V _{DC}	250 V _{DC}	400 V _{DC}	630 V _{DC}	1000 V _{DC}	
10	12	18	-	36	52	70	260	
15	8	10	-	20	32	66	130	
22.5	5	6	-	12	18	38	68	
27.5	3	5	6	8	14	28	50	
37.5	0.8	1	2	3	-	-	-	
52.5	0.2	0.3	0.4	1	-	-	-	
If the maximum pulse voltage is less than the rated voltage higher dU/dt values can be permitted.								
R between leads, for C $\leq 0.33 \mu$ F and U _R ≤ 100 V					> 15 000 M Ω			
R between leads, for C $\leq 0.33 \mu$ F and U _R > 100 V					> 30 000 M Ω			
RC between leads, for C > 0.33 μ F and U _R ≤ 100 V					> 5000 s			
RC between leads, for C > 0.33 μ F and U _R > 100 V					> 10 000 s			
R between leads and case, 100 V; (foil method)					> 30 000 M Ω			
Withstanding (DC) voltage (cut off current 10 mA) ⁽¹⁾ ; rise time < 1000 V/s					1.6 x U _{RDC} , 1 min			
Withstanding (DC) leads and case					2 x U _{RDC} , 1 min			
Maximum application temperature					125 °C			

Note

- ⁽¹⁾ See "Voltage Proof Test for Metalized Film Capacitors": www.vishay.com/doc?28169



ELECTRICAL DATA								
U _{RDC} (V)	CAP. (µF)	CAPACITANCE CODE	VOLTAGE CODE	V _{AC}	DIMENSIONS w x h x l (mm)	PCM (mm)	d _t ± 0.08 mm (mm)	ORDERING CODE FOR 10 % TOL./BULK PACKING ⁽¹⁾
63	0.22	422	06	40	3.5 x 8.0 x 13.0	10.0	0.80	MKT1820422065
	0.33	433			3.5 x 8.0 x 13.0	10.0		MKT1820433065
	0.47	447			3.5 x 8.0 x 13.0	10.0		MKT1820447065
	0.68	468			4.0 x 9.0 x 13.0	10.0		MKT1820468065
	1.0	510			4.5 x 9.5 x 13.0	10.0		MKT1820510065
	1.5	515			5.5 x 10.5 x 13.0	10.0		MKT1820515065
	2.2	522			6.5 x 11.5 x 13.0	10.0		MKT1820522065
	3.3	533			9.0 x 15.5 x 13.0	10.0		MKT1820533065M
	3.3	533			6.5 x 12.5 x 18.0	15.0		MKT1820533065
	4.7	547			9.0 x 15.5 x 13.0	10.0		MKT1820547065M
	4.7	547			7.5 x 13.5 x 18.0	15.0		MKT1820547065
	6.8	568			8.5 x 14.5 x 18.0	15.0		MKT1820568065
	10.0	610			8.5 x 17.5 x 18.0	15.0		MKT1820610065
	15.0	615			8.5 x 16.5 x 26.5	22.5		MKT1820615065
	22.0	622			10.5 x 18.5 x 26.5	22.5		MKT1820622065M
	18.0	618			9.0 x 19.0 x 32.0	27.5		MKT1820618065
	22.0	622			11.0 x 21.0 x 32.0	27.5		MKT1820622065
	27.0	627			11.0 x 21.0 x 32.0	27.5		MKT1820627065
	33.0	633			13.0 x 23.0 x 32.0	27.5		MKT1820633065
	39.0	639			13.0 x 23.0 x 32.0	27.5		MKT1820639065
	47.0	647			15.0 x 25.0 x 32.0	27.5	MKT1820647065	
	56.0	656			18.0 x 28.0 x 32.0	27.5	MKT1820656065	
	68.0	668			18.0 x 28.0 x 32.0	27.5	MKT1820668065	
	82.0	682			21.0 x 31.0 x 32.0	27.5	MKT1820682065	
	100.0	710			21.0 x 31.0 x 32.0	27.5	MKT1820710065M	
	100.0	710			18.5 x 35.5 x 43.0	37.5	MKT1820710065	
	120.0	712			18.5 x 35.5 x 43.0	37.5	MKT1820712065	
	150.0	715			18.5 x 35.5 x 43.0	37.5	MKT1820715065	
	180.0	718			21.5 x 38.5 x 43.0	37.5	MKT1820718065	
	220.0	722			24.0 x 44.0 x 42.0	37.5	MKT1820722065M	
	270.0	727			30.0 x 45.0 x 42.0	37.5	MKT1820727065M	
	330.0	733			30.0 x 45.0 x 42.0	37.5	MKT1820733065M	
	220.0	722			25.0 x 45.0 x 57.5	52.5	MKT1820722065	
270.0	727	25.0 x 45.0 x 57.5	52.5	MKT1820727065				
330.0	733	25.0 x 45.0 x 57.5	52.5	MKT1820733065				
390.0	739	30.0 x 45.0 x 57.5	52.5	MKT1820739065				
470.0	747	35.0 x 50.0 x 57.5	52.5	MKT1820747065				
560.0	756	35.0 x 50.0 x 57.5	52.5	MKT1820756065				

Note

⁽¹⁾ Please replace "5" by: "4" for 5 % tolerance or "6" for 20 % tolerance



ELECTRICAL DATA								
U _{RDC} (V)	CAP. (μF)	CAPACITANCE CODE	VOLTAGE CODE	V _{AC}	DIMENSIONS w x h x l (mm)	PCM (mm)	d _t ± 0.08 mm (mm)	ORDERING CODE FOR 10 % TOL./BULK PACKING ⁽¹⁾
100	0.068	368	01	63	3.5 x 8.0 x 13.0	10.0	0.8	MKT1820368015
	0.10	410			3.5 x 8.0 x 13.0	10.0		MKT1820410015
	0.15	415			3.5 x 8.0 x 13.0	10.0		MKT1820415015
	0.22	422			3.5 x 8.0 x 13.0	10.0		MKT1820422015
	0.33	433			4.0 x 9.0 x 13.0	10.0		MKT1820433015
	0.47	447			4.5 x 9.5 x 13.0	10.0		MKT1820447015
	0.68	468			5.5 x 10.5 x 13.0	10.0		MKT1820468015
	1.0	510			5.5 x 10.5 x 13.0	10.0		MKT1820510015M
	1.0	510			5.5 x 10.5 x 18.0	15.0		MKT1820510015
	1.5	515			6.5 x 12.5 x 18.0	15.0		MKT1820515015
	2.2	522			6.5 x 12.5 x 18.0	15.0		MKT1820522015
	3.3	533			8.5 x 14.5 x 18.0	15.0		MKT1820533015
	4.7	547			8.5 x 14.5 x 18.0	15.0		MKT1820547015M
	4.7	547			7.5 x 15.5 x 26.5	22.5		MKT1820547015
	6.8	568			8.5 x 16.5 x 26.5	22.5		MKT1820568015
	10.0	610			10.5 x 18.5 x 26.5	22.5		MKT1820610015
	15.0	615			10.5 x 18.5 x 26.5	22.5		MKT1820615015M
	15.0	615			11.0 x 21.0 x 32.0	27.5		MKT1820615015
	18.0	618			13.0 x 23.0 x 32.0	27.5	MKT1820618015	
	22.0	622			13.0 x 23.0 x 32.0	27.5	MKT1820622015	
	27.0	627			15.0 x 25.0 x 32.0	27.5	MKT1820627015	
	33.0	633			18.0 x 28.0 x 32.0	27.5	MKT1820633015	
	39.0	639			18.0 x 28.0 x 32.0	27.5	MKT1820639015	
	47.0	647			21.0 x 31.0 x 32.0	27.5	MKT1820647015	
	56.0	656			21.0 x 31.0 x 32.0	27.5	MKT1820656015M	
	56.0	656			18.5 x 35.5 x 43.0	37.5	MKT1820656015	
	68.0	668			18.5 x 35.5 x 43.0	37.5	MKT1820668015	
	82.0	682			18.5 x 35.5 x 43.0	37.5	MKT1820682015	
	100.0	710			21.5 x 38.5 x 43.0	37.5	MKT1820710015	
	120.0	712			24.0 x 44.0 x 42.0	37.5	MKT1820712015M	
	150.0	715			30.0 x 45.0 x 42.0	37.5	MKT1820715015M	
	180.0	718			30.0 x 45.0 x 42.0	37.5	MKT1820718015M	
	120.0	712			25.0 x 45.0 x 57.5	52.5	MKT1820712015	
150.0	715	25.0 x 45.0 x 57.5	52.5	MKT1820715015				
180.0	718	25.0 x 45.0 x 57.5	52.5	MKT1820718015				
220.0	722	30.0 x 45.0 x 57.5	52.5	MKT1820722015				
270.0	727	35.0 x 50.0 x 57.5	52.5	MKT1820727015				
330.0	733	35.0 x 50.0 x 57.5	52.5	MKT1820733015				

Note

(1) Please replace "5" by: "4" for 5 % tolerance or "6" for 20 % tolerance



ELECTRICAL DATA									
U _{RDC} (V)	CAP. (µF)	CAPACITANCE CODE	VOLTAGE CODE	V _{AC}	DIMENSIONS w x h x l (mm)	PCM (mm)	d _t ± 0.08 mm (mm)	ORDERING CODE FOR 10 % TOL./BULK PACKING ⁽¹⁾	
160	4.7	547	16	63	9.0 x 19.0 x 32.0	27.5	0.8	MKT1820547165	
	6.8	568			11.0 x 21.0 x 32.0	27.5		MKT1820568165	
	10.0	610			11.0 x 21.0 x 32.0	27.5		MKT1820610165	
	15.0	615			13.0 x 23.0 x 32.0	27.5		MKT1820615165	
	18.0	618			15.0 x 25.0 x 32.0	27.5		MKT1820618165	
	22.0	622			18.0 x 28.0 x 32.0	27.5		MKT1820622165	
	27.0	627			18.0 x 28.0 x 32.0	27.5		MKT1820627165	
	33.0	633			31.0 x 31.0 x 32.0	27.5		MKT1820633165M	
	33.0	633			18.5 x 35.5 x 43.0	37.5	1.0	MKT1820633165	
	39.0	639			18.5 x 35.5 x 43.0	37.5		MKT1820639165	
	47.0	647			18.5 x 35.5 x 43.0	37.5		MKT1820647165	
	56.0	656			21.5 x 38.5 x 43.0	37.5		MKT1820656165	
	68.0	668			21.5 x 38.5 x 43.0	37.5		MKT1820668165	
	82.0	682			24.0 x 44.0 x 42.0	37.5		MKT1820682165M	
	100.0	710			30.0 x 45.0 x 42.0	37.5		MKT1820710165M	
	120.0	712			30.0 x 45.0 x 42.0	37.5		MKT1820712165M	
	82.0	682			25.0 x 45.0 x 57.5	52.5		1.2	MKT1820682165
	100.0	710			25.0 x 45.0 x 57.5	52.5			MKT1820710165
	120.0	712			25.0 x 45.0 x 57.5	52.5	MKT1820712165		
	150.0	715			30.0 x 45.0 x 57.5	52.5	MKT1820715165		
	180.0	718			35.0 x 50.0 x 57.5	52.5	MKT1820718165		
	220.0	722			35.0 x 50.0 x 57.5	52.5	MKT1820722165		
250	0.022	322	25	160	3.5 x 8.0 x 13.0	10.0	0.8		MKT1820322255
	0.033	333			3.5 x 8.0 x 13.0	10.0			MKT1820333255
	0.047	347			3.5 x 8.0 x 13.0	10.0		MKT1820347255	
	0.068	368			3.5 x 8.0 x 13.0	10.0		MKT1820368255	
	0.10	410			4.5 x 9.5 x 13.0	10.0		MKT1820410255	
	0.15	415			5.5 x 10.5 x 13.0	10.0		MKT1820415255	
	0.22	422			6.5 x 11.5 x 13.0	10.0		MKT1820422255	
	0.33	433			6.5 x 11.5 x 13.0	10.0		MKT1820433255M	
	0.33	433			5.5 x 10.5 x 18.0	15.0		MKT1820433255	
	0.47	447			9.0 x 15.5 x 13.0	10.0		MKT1820447255M	
	0.47	447			6.5 x 12.5 x 18.0	15.0		MKT1820447255	
	0.68	468			7.5 x 13.5 x 18.0	15.0		MKT1820468255	
	1.0	510			8.5 x 14.5 x 18.0	15.0		MKT1820510255	
	1.5	515			10.5 x 17.5 x 18.0	15.0		MKT1820515255M	
	1.5	515			8.5 x 16.5 x 26.5	22.5		MKT1820515255	
	2.2	522			10.5 x 18.5 x 26.5	22.5		MKT1820522255	
	3.3	533			12.5 x 20.0 x 26.5	22.5		MKT1820533255	

Note

⁽¹⁾ Please replace "5" by: "4" for 5 % tolerance or "6" for 20 % tolerance



ELECTRICAL DATA											
U _{RDC} (V)	CAP. (µF)	CAPACITANCE CODE	VOLTAGE CODE	V _{AC}	DIMENSIONS w x h x l (mm)	PCM (mm)	d _t ± 0.08 mm (mm)	ORDERING CODE FOR 10 % TOL./BULK PACKING ⁽¹⁾			
250	4.7	547	25	100	11.0 x 21.0 x 32.0	27.5	0.8	MKT1820547255			
	6.8	568			13.0 x 23.0 x 32.0	27.5		MKT1820568255			
	10.0	610			15.0 x 25.0 x 32.0	27.5		MKT1820610255			
	15.0	615			18.0 x 28.0 x 32.0	27.5		MKT1820615255			
	18.0	618			21.0 x 31.0 x 32.0	27.5		MKT1820618255M			
	18.0	618			18.5 x 35.5 x 43.0	37.5		MKT1820618255			
	22.0	622			18.5 x 35.5 x 43.0	37.5	MKT1820622255				
	27.0	627			18.5 x 35.5 x 43.0	37.5	MKT1820627255				
	33.0	633			21.5 x 38.5 x 43.0	37.5	MKT1820633255				
	39.0	639			21.5 x 38.5 x 43.0	37.5	MKT1820639255				
	47.0	647			24.0 x 44.0 x 42.0	37.5	MKT1820647255				
	56.0	656			30.0 x 45.0 x 42.0	37.5	MKT1820656255				
	68.0	668			30.0 x 45.0 x 42.0	37.5	MKT1820668255				
	56.0	656			25.0 x 45.0 x 57.5	52.5	MKT1820656255M				
	68.0	668			25.0 x 45.0 x 57.5	52.5	MKT1820668255M				
	82.0	682			25.0 x 45.0 x 57.5	52.5	MKT1820682255				
	100.0	710			30.0 x 45.0 x 57.5	52.5	MKT1820710255				
	120.0	712			35.0 x 50.0 x 57.5	52.5	MKT1820712255				
	400	0.010			310	40	200	3.5 x 8.0 x 13.0	10.0	0.8	MKT1820310405
		0.015			315			3.5 x 8.0 x 13.0	10.0		MKT1820315405
0.022		322	3.5 x 8.0 x 13.0	10.0	MKT1820322405						
0.033		333	4.0 x 9.0 x 13.0	10.0	MKT1820333405						
0.047		347	4.5 x 9.5 x 13.0	10.0	MKT1820347405						
0.068		368	5.5 x 10.5 x 13.0	10.0	MKT1820368405						
0.10		410	6.5 x 11.5 x 13.0	10.0	MKT1820410405						
0.15		415	9.0 x 15.5 x 13.0	10.0	MKT1820415405M						
0.15		415	6.5 x 12.5 x 18.0	15.0	MKT1820415405						
0.22		422	9.0 x 15.5 x 13.0	10.0	MKT1820422405M						
0.22		422	6.5 x 12.5 x 18.0	15.0	MKT1820422405						
0.33		433	7.5 x 13.5 x 18.0	15.0	MKT1820433405						
0.47		447	8.5 x 17.5 x 18.0	15.0	MKT1820447405						
0.68		468	8.5 x 16.5 x 26.5	22.5	MKT1820468405						
1.0		510	10.5 x 18.5 x 26.5	22.5	MKT1820510405						
1.5		515	11.0 x 21.0 x 26.5	22.5	MKT1820515405M						
1.5		515	11.0 x 21.0 x 31.0	27.5	MKT1820515405						
2.2		522	13.5 x 23.5 x 31.5	27.5	MKT1820522405						
3.3		533	15 x 24.5 x 31.5	27.5	MKT1820533405						
4.7		547	18.0 x 28.0 x 31.5	27.5	MKT1820547405						

Note

(1) Please replace "5" by: "4" for 5 % tolerance or "6" for 20 % tolerance



ELECTRICAL DATA								
U _{RDC} (V)	CAP. (μF)	CAPACITANCE CODE	VOLTAGE CODE	V _{AC}	DIMENSIONS w x h x l (mm)	PCM (mm)	d _t ± 0.08 mm (mm)	ORDERING CODE FOR 10 % TOL./BULK PACKING ⁽¹⁾
630	0.0010	210	63	220	3.5 x 8.0 x 13.0	10.0	0.80	MKT1820210635
	0.0015	215			3.5 x 8.0 x 13.0	10.0		MKT1820215635
	0.0022	222			3.5 x 8.0 x 13.0	10.0		MKT1820222635
	0.0033	233			3.5 x 8.0 x 13.0	10.0		MKT1820233635
	0.0047	247			3.5 x 8.0 x 13.0	10.0		MKT1820247635
	0.0068	268			3.5 x 8.0 x 13.0	10.0		MKT1820268635
	0.010	310			4.0 x 9.0 x 13.0	10.0		MKT1820310635
	0.015	315			4.5 x 9.5 x 13.0	10.0		MKT1820315635
	0.022	322			5.5 x 10.5 x 13.0	10.0		MKT1820322635
	0.033	333			6.5 x 11.5 x 13.0	10.0		MKT1820333635M
	0.033	333			5.5 x 10.5 x 18.0	15.0		MKT1820333635
	0.047	347			6.5 x 11.5 x 13.0	10.0		MKT1820347635M
	0.047	347			6.5 x 12.5 x 18.0	15.0		MKT1820347635
	0.068	368			7.5 x 13.5 x 18.0	15.0		MKT1820368635
	0.10	410			7.5 x 13.5 x 18.0	15.0		MKT1820410635M
	0.10	410			6.5 x 14.5 x 26.5	22.5		MKT1820410635
	0.15	415			7.5 x 15.5 x 26.5	22.5		MKT1820415635
	0.22	422			8.5 x 16.5 x 26.5	22.5		MKT1820422635
	0.33	433			11.0 x 21.0 x 31.0	27.5		MKT1820433635
	0.47	447			11.0 x 21.0 x 31.0	27.5		MKT1820447635
0.68	468	13.5 x 23.5 x 31.5	27.5	MKT1820468635				
1.0	510	15.0 x 24.5 x 31.5	27.5	MKT1820510635				
1.5	515	18.0 x 28.0 x 31.5	27.5	MKT1820515635				
1000	0.0010	210	10	220	4.0 x 9.0 x 13.0	10.0	0.80	MKT1820210105
	0.0015	215			4.0 x 9.0 x 13.0	10.0		MKT1820215105
	0.0022	222			4.0 x 9.0 x 13.0	10.0		MKT1820222105
	0.0033	233			4.0 x 9.0 x 13.0	10.0		MKT1820233105
	0.0047	247			5.5 x 10.5 x 13.0	10.0		MKT1820247105
	0.0068	268			6.5 x 11.5 x 13.0	10.0		MKT1820268105
	0.010	310			5.5 x 10.5 x 18.0	15.0		MKT1820310105
	0.015	315			6.5 x 12.5 x 18.0	15.0		MKT1820315105
	0.022	322			7.5 x 13.5 x 18.0	15.0		MKT1820322105
	0.033	333			8.5 x 14.5 x 18.0	15.0		MKT1820333105M
	0.033	333			6.5 x 14.5 x 26.5	22.5		MKT1820333105
	0.047	347			7.5 x 15.5 x 26.5	22.5		MKT1820347105
	0.068	368			8.5 x 16.5 x 26.5	22.5		MKT1820368105
	0.10	410			10.5 x 18.5 x 26.5	22.5		MKT1820410105
	0.15	415			11.0 x 21.0 x 31.0	27.5		MKT1820415105
	0.22	422			13.5 x 23.5 x 31.5	27.5		MKT1820422105
	0.33	433			16.5 x 29.5 x 31.5	27.5		MKT1820433105
0.47	447	20.0 x 35.0 x 31.5	27.5	MKT1820447105				

Note

⁽¹⁾ Please replace "5" by: "4" for 5 % tolerance or "6" for 20 % tolerance

RECOMMENDED PACKAGING								
PACKAGING CODE	TYPE OF PACKAGING	HEIGHT (H) (mm)	REEL DIAMETER/ BOX SIZE (mm)	ORDERING CODE EXAMPLES	PITCH 10	PITCH 15	PITCH 22.5 TO 27.5	PITCH 37.5 TO 52.5
G	Ammo	18.5	55 x 210 x 340	MKT1820410405G	x	x	-	-
W	Reel	18.5	350	MKT1820410405W	x	x	-	-
V	Reel	18.5	500	MKT1820422635V	-	x	x	-
G	Ammo	18.5	60 x 360 x 510	MKT1820422635G	-	-	x	-
-	Bulk	-	-	MKT1820515405	x	x	x	x

EXAMPLE OF ORDERING CODE				
TYPE	CAPACITANCE CODE	VOLTAGE CODE	TOLERANCE CODE (1)	PACKAGING CODE
MKT1820	410	06	5	G

MOUNTING

Normal Use

The capacitors are designed for mounting on printed-circuit boards. The capacitors packed in bandoliers are designed for mounting on printed-circuit boards by means of automatic insertion machines.

For detailed tape specifications refer to packaging information www.vishay.com/docs?28139

Specific Method of Mounting to Withstand Vibration and Shock

In order to withstand vibration and shock tests, it must be ensured that the stand-off pips are in good contact with the printed-circuit board.

- For pitches ≤ 15 mm the capacitors shall be mechanically fixed by the leads
- For larger pitches the capacitors shall be mounted in the same way and the body clamped

Space Requirements on Printed-Circuit Board

The maximum space for length ($l_{max.}$), width ($w_{max.}$) and height ($h_{max.}$) of film capacitors to take in account on the printed-circuit board is shown in the drawings.

- For products with pitch ≤ 15 mm, $\Delta w = \Delta l = 0.3$ mm; $\Delta h = 0.1$ mm
- For products with 15 mm $<$ pitch ≤ 27.5 mm, $\Delta w = \Delta l = 0.5$ mm; $\Delta h = 0.1$ mm
- For products with 27.5 mm $<$ pitch ≤ 52.5 mm, $\Delta w = \Delta l = 0.5$ mm; $\Delta h = 0.5$ mm

Eccentricity defined as in drawing. The maximum eccentricity is smaller than or equal to the lead diameter of the product concerned.

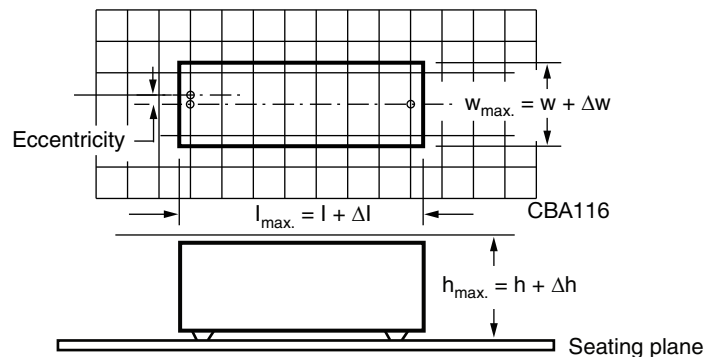

SOLDERING CONDITIONS

For general soldering conditions and wave soldering profile, we refer to the application note: "Soldering Guidelines for Film Capacitors": www.vishay.com/doc?28171

Storage Temperature

$T_{stg} = -25$ °C to $+35$ °C with RH maximum 75 % without condensation

Ratings and Characteristics Reference Conditions

Unless otherwise specified, all electrical values apply to an ambient free temperature of 23 °C ± 1 °C, an atmospheric pressure of 86 kPa to 106 kPa and a relative humidity of 50 % ± 2 %.

For reference testing, a conditioning period shall be applied over 96 h ± 4 h by heating the products in a circulating air oven at the rated temperature and a relative humidity not exceeding 20 %.



CHARACTERISTICS

PERMISSIBLE AC VOLTAGE VS. FREQUENCY AT $T_{amb} \leq 85^\circ C$





CHARACTERISTICS

PERMISSIBLE AC VOLTAGE VS. FREQUENCY AT T_{amb} ≤ 85 °C



CHARACTERISTICS



Nominal voltage (AC and DC) as a function of temperature

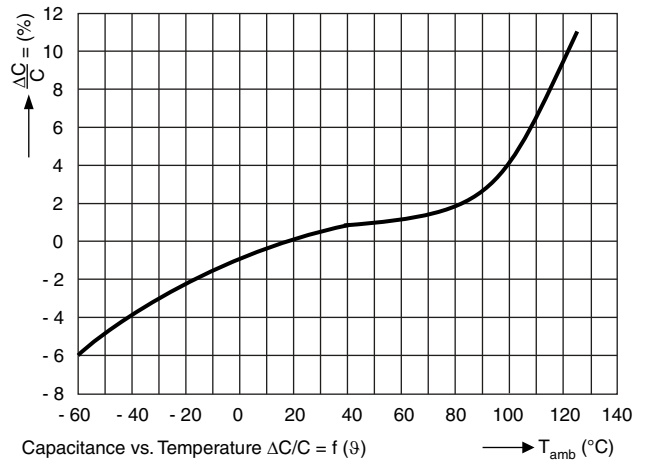

Capacitance vs. Temperature $\Delta C/C = f(\vartheta)$
Capacitance as a function of temperature (typical curve)

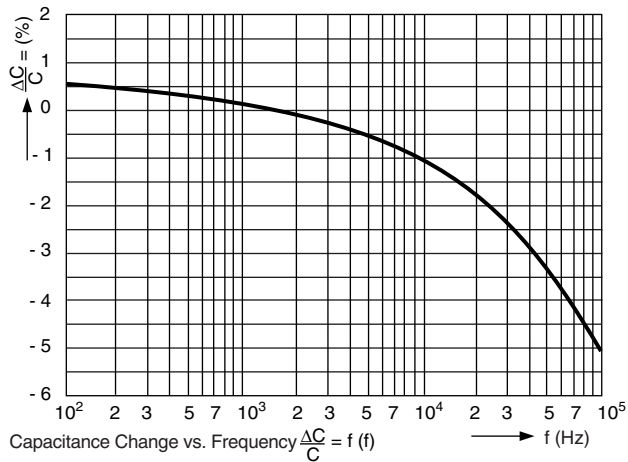

Capacitance Change vs. Frequency $\Delta C/C = f(f)$
Capacitance as a function of frequency (typical curve)

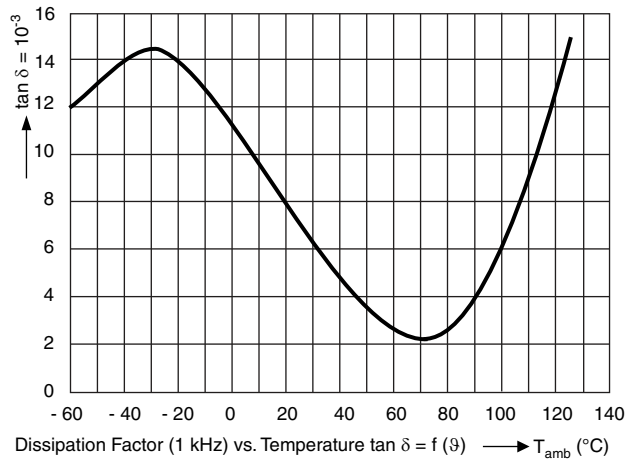

Dissipation Factor (1 kHz) vs. Temperature $\tan \delta = f(\vartheta)$
Dissipation factor as a function of temperature (typical curve)



Insulation resistance as a function of temperature (typical curve)

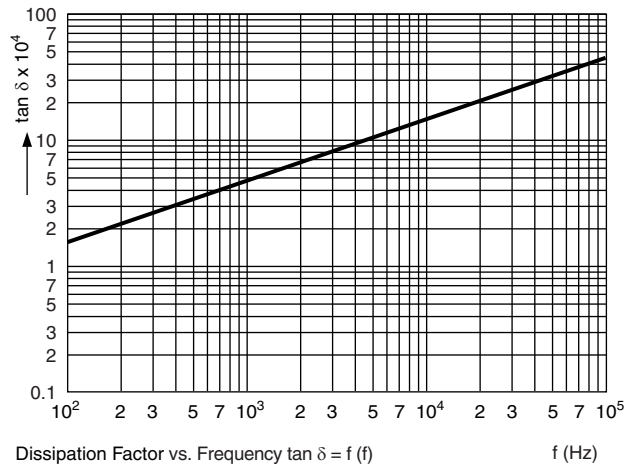

Dissipation Factor vs. Frequency tan δ = f (f) Dissipation factor as a function of frequency (typical curve)

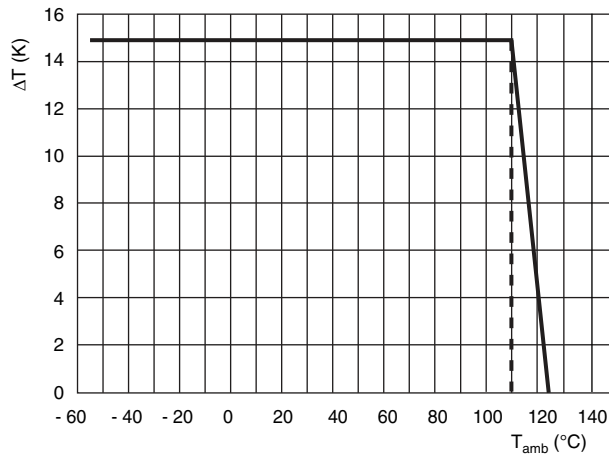

Maximum allowed component temperature rise (ΔT) as function of ambient temperature (T_{amb})

HEAT CONDUCTIVITY (G) AS A FUNCTION OF CAPACITOR BODY THICKNESS IN mW/°C						
W_{max.} (mm)	HEAT CONDUCTIVITY (mW/°C)					
	PITCH 10.0 mm	PITCH 15.0 mm	PITCH 22.5 mm	PITCH 27.5 mm	PITCH 37.5 mm	PITCH 52.5 mm
3.5	5.0	-	-	-	-	-
4.0	6.0	-	-	-	-	-
4.5	7.0	-	-	-	-	-
5.5	8.0	10.0	-	-	-	-
6.5	10.0	13.0	20.0	-	-	-
7.5	-	15.0	22.0	-	-	-
8.5	-	16.0	24.0	-	-	-
9.0	-	-	-	32.0	-	-
10.5	-	-	30.0	-	-	-
11.0	-	-	-	38.0	-	-
11.5	-	-	-	38.0	-	-
12.5	-	-	34.0	-	-	-
13.0	-	-	-	45.0	-	-
13.5	-	-	-	45.0	-	-
15.0	-	-	-	50.0	-	-
16.5	-	-	-	58.0	-	-
18.0	-	-	-	60.0	-	-
18.5	-	-	-	-	90.0	-
20.0	-	-	-	73.0	-	-
21.0	-	-	-	70.0	-	-
21.5	-	-	-	-	102.0	-
24.0	-	-	-	-	118.0	-
25.0	-	-	-	-	-	155.0
30.0	-	-	-	-	135.0	170.0
35.0	-	-	-	-	-	200.0

POWER DISSIPATION AND MAXIMUM COMPONENT TEMPERATURE RISE

The power dissipation must be limited in order not to exceed the maximum allowed component temperature rise as a function of the free air ambient temperature.

The component temperature rise (ΔT) can be measured or calculated by $\Delta T = P/G$:

- ΔT = component temperature rise (°C) with a maximum of 15 °C
- P = power dissipation of the component (mW)
- G = heat conductivity of the component (mW/°C)

MEASURING THE COMPONENT TEMPERATURE

A thermocouple must be attached to the capacitor body as in:



The temperature is measured in unloaded (T_{amb}) and maximum loaded condition (T_C).

The temperature rise is given by $\Delta T = T_C - T_{amb}$.

To avoid thermal radiation or convection, the capacitor must be tested in a closed area from air circulation.



APPLICATION NOTE AND LIMITING CONDITIONS

These capacitors are not suitable for mains applications as across-the-line capacitors without additional protection, as described hereunder. These mains applications are strictly regulated in safety standards and therefore electromagnetic interference suppression capacitors conforming the standards must be used.

To select the capacitor for a certain application, the following conditions must be checked:

1. The peak voltage (U_P) shall not be greater than the rated DC voltage (U_{RDC})
2. The peak-to-peak voltage (U_{P-P}) shall not be greater than the maximum (U_{P-P}) to avoid the ionization inception level
3. The voltage peak slope (dU/dt) shall not exceed the rated voltage pulse slope in an RC-circuit at rated voltage and without ringing. If the pulse voltage is lower than the rated DC voltage, the rated voltage pulse slope may be multiplied by U_{RDC} and divided by the applied voltage.

For all other pulses following equation must be fulfilled:

$$2 \times \int_0^T \left(\frac{dU}{dt}\right)^2 \times dt < U_{NDC} \times \left(\frac{dU}{dt}\right)_{rated}$$

T is the pulse duration.

4. The maximum component surface temperature rise must be lower than the limits (see graph "Max. allowed component temperature rise").
5. Since in circuits used at voltages over 280 V peak-to-peak the risk for an intrinsically active flammability after a capacitor breakdown (short circuit) increases, it is recommended that the power to the component is limited to 100 times the values mentioned in the table: "Heat conductivity"
6. When using these capacitors as across-the-line capacitor in the input filter for mains applications or as series connected with an impedance to the mains the applicant must guarantee that the following conditions are fulfilled in any case (spikes and surge voltages from the mains included).
7. For capacitors connected in parallel, normally the proof voltage and possibly the rated voltage must be reduced. For information depending of the capacitance value and the number of parallel connections contact dc-film@vishay.com.

VOLTAGE CONDITIONS FOR 6 ABOVE			
ALLOWED VOLTAGES	$T_{amb} \leq 85 \text{ }^\circ\text{C}$	$85 \text{ }^\circ\text{C} < T_{amb} \leq 100 \text{ }^\circ\text{C}$	$100 \text{ }^\circ\text{C} < T_{amb} \leq 125 \text{ }^\circ\text{C}$
Maximum continuous RMS voltage	U_{RAC}	$0.8 \times U_{RAC}$	$0.5 \times U_{RAC}$
Maximum temperature RMS-overvoltage (< 24 h)	$1.25 \times U_{RAC}$	U_{RAC}	$0.6 \times U_{RAC}$
Maximum peak voltage (V_{O-P}) (< 2 s)	$1.6 \times U_{RDC}$	$1.3 \times U_{RDC}$	$0.5 \times U_{RDC}$



INSPECTION REQUIREMENTS

General Notes

Sub-clause numbers of tests and performance requirements refer to the “Sectional Specification, Publication IEC 60384-2 and Specific Reference Data”.

GROUP C INSPECTION REQUIREMENTS		
SUB-CLAUSE NUMBER AND TEST	CONDITIONS	PERFORMANCE REQUIREMENTS
SUB-GROUP C1A PART OF SAMPLE OF SUB-GROUP C1		
4.1 Dimensions (detail)		As specified in chapter “General Data” of this specification
4.3.1 Initial measurements	Capacitance Tangent of loss angle: for C ≤ 1 µF at 10 kHz for 1 µF < C < 100 µF at 1 kHz for C ≥ 100 µF at 100 Hz	
4.3 Robustness of terminations	Tensile and bending	No visible damage
4.4 Resistance to soldering heat	Method: 1A Solder bath: 280 °C ± 5 °C Duration: 10 s	
4.14 Component solvent resistance	Isopropylalcohol at room temperature Method: 2 Immersion time: 5 min ± 0.5 min Recovery time: min. 1 h, max. 2 h	
4.4.2 Final measurements	Visual examination	No visible damage Legible marking
	Capacitance	$ \Delta C/C \leq 2\%$ of the value measured initially
	Tangent of loss angle	Increase of tan δ: ≤ 0.003 for C ≤ 1 µF or ≤ 0.002 for C > 1 µF ≤ 0.004 for C ≥ 100 µF Compared to values measured in 4.3.1
SUB-GROUP C1B PART OF SAMPLE OF SUB-GROUP C1		
4.6.1 Initial measurements	Capacitance Tangent of loss angle: for C ≤ 1 µF at 10 kHz for 1 µF < C < 100 µF at 1 kHz for C ≥ 100 µF at 100 Hz	
4.6 Rapid change of temperature	θA = -55 °C θB = +125 °C 5 cycles Duration t = 30 min Visual examination	No visible damage Legible marking
4.7 Vibration	Mounting: see section “Mounting” of this specification Procedure B4 Frequency range: 10 Hz to 55 Hz Amplitude: 0.75 mm or Acceleration 98 m/s ² (whichever is less severe) Total duration 6 h	
4.7.2 Final inspection	Visual examination	No visible damage
4.9 Shock	Mounting: see section “Mounting” for more information Pulse shape: half sine Acceleration: 490 m/s ² Duration of pulse: 11 ms	



GROUP C INSPECTION REQUIREMENTS		
SUB-CLAUSE NUMBER AND TEST	CONDITIONS	PERFORMANCE REQUIREMENTS
SUB-GROUP C1B PART OF SAMPLE OF SUB-GROUP C1		
4.9.3 Final measurements	Visual examination Capacitance Tangent of loss angle For $C \leq 1 \mu\text{F}$ at 10 kHz For $1 \mu\text{F} < C < 100 \mu\text{F}$ at 1 kHz For $C \geq 100 \mu\text{F}$ at 100 Hz Insulation resistance	No visible damage $ \Delta C/C \leq 5\%$ of the value measured in 4.6.1 Increase of $\tan \delta$: ≤ 0.003 for $C \leq 1 \mu\text{F}$ or ≤ 0.002 for $C > 1 \mu\text{F}$ ≤ 0.004 for $C \geq 100 \mu\text{F}$ Compared to values measured in 4.6.1 As specified in section "Insulation Resistance" of this specification
SUB-GROUP C1 COMBINED SAMPLE OF SPECIMENS OF SUB-GROUPS C1A AND C1B		
4.10 Climatic sequence 4.10.2 Dry heat 4.10.3 Damp heat cyclic Test Db, first cycle 4.10.4 Cold 4.10.6 Damp heat cyclic Test Db, remaining cycles 4.10.6.2 Final measurements	Temperature: +125 °C Duration: 16 h Temperature: -55 °C Duration: 2 h Voltage proof = U_{RDC} for 1 min within 15 min after removal from testchamber Visual examination Capacitance Tangent of loss angle For $C \leq 1 \mu\text{F}$ at 10 kHz For $1 \mu\text{F} < C < 100 \mu\text{F}$ at 1 kHz For $C \geq 100 \mu\text{F}$ at 100 Hz Insulation resistance	No breakdown or flashover No visible damage Legible marking $ \Delta C/C \leq 5\%$ of the value measured in 4.4.2 or 4.9.3 Increase of $\tan \delta$: ≤ 0.005 for $C \leq 1 \mu\text{F}$ or ≤ 0.003 for $C > 1 \mu\text{F}$ ≤ 0.004 for $C \geq 100 \mu\text{F}$ Compared to values measured in 4.3.1 or 4.6.1 $\geq 50\%$ of values specified in section "Insulation Resistance" of this specification
SUB-GROUP C2		
4.11 Damp heat steady state 4.11.1 Initial measurements 4.11.3 Final measurements	56 days; 40 °C; 90 % to 95 % RH Capacitance Tangent of loss angle For $C \leq 1 \mu\text{F}$ at 10 kHz For $1 \mu\text{F} < C < 100 \mu\text{F}$ at 1 kHz For $C \geq 100 \mu\text{F}$ at 100 Hz Voltage proof = U_{RDC} for 1 min within 15 min after removal from testchamber Visual examination	No breakdown or flashover No visible damage Legible marking



GROUP C INSPECTION REQUIREMENTS		
SUB-CLAUSE NUMBER AND TEST	CONDITIONS	PERFORMANCE REQUIREMENTS
SUB-GROUP C2		
4.11.3 Final measurements	Capacitance Tangent of loss angle For $C \leq 1 \mu\text{F}$ at 10 kHz For $1 \mu\text{F} < C < 100 \mu\text{F}$ at 1 kHz For $C \geq 100 \mu\text{F}$ at 100 Hz Insulation resistance	$ \Delta C/C \leq 5\%$ of the value measured in 4.11.1. Increase of $\tan \delta$ ≤ 0.005 for $C \leq 1 \mu\text{F}$ or ≤ 0.003 for $C > 1 \mu\text{F}$ ≤ 0.004 for $C \geq 100 \mu\text{F}$ Compared to values measured in 4.11.1 $\geq 50\%$ of values specified in section "Insulation Resistance" of this specification
SUB-GROUP C3		
4.12 Endurance	Duration: 2000 h $1.25 \times U_{\text{RDC}}$ at 85 °C $1.0 \times U_{\text{RDC}}$ at 100 °C $0.6 \times U_{\text{RDC}}$ at 125 °C Duration: 200 h $0.3 \times U_{\text{RDC}}$ at 150 °C (not applicable for pitch ≥ 37.5 mm)	
4.12.1 Initial measurements	Capacitance Tangent of loss angle: for $C \leq 1 \mu\text{F}$ at 10 kHz for $1 \mu\text{F} < C < 100 \mu\text{F}$ at 1 kHz for $C \geq 100 \mu\text{F}$ at 100 Hz	
4.12.5 Final measurements	Visual examination Capacitance Tangent of loss angle For $C \leq 1 \mu\text{F}$ at 10 kHz For $1 \mu\text{F} < C < 100 \mu\text{F}$ at 1 kHz For $C \geq 100 \mu\text{F}$ at 100 Hz Insulation resistance	No visible damage Legible marking $ \Delta C/C \leq 5\%$ compared to values measured in 4.12.1 Increase of $\tan \delta$: ≤ 0.003 for $C \leq 1 \mu\text{F}$ or ≤ 0.002 for $1 \mu\text{F} < C < 100 \mu\text{F}$ ≤ 0.004 for $C \geq 100 \mu\text{F}$ Compared to values measured in 4.12.1 $\geq 50\%$ of values specified in section "Insulation Resistance" of this specification
SUB-GROUP C4		
4.13 Charge and discharge	10 000 cycles Charged to U_{RDC} Discharge resistance: $R = \frac{U_R}{C \times K \times \mu(dU/dt)_R}$ K = 5 for pitch ≤ 27.5 mm K = 1.5 for pitch 37.5 mm/52.5 mm	
4.13.1 Initial measurements	Capacitance Tangent of loss angle: for $C \leq 1 \mu\text{F}$ at 10 kHz for $1 \mu\text{F} < C < 100 \mu\text{F}$ at 1 kHz for $C \geq 100 \mu\text{F}$ at 100 Hz	
4.13.3 Final measurements	Capacitance Tangent of loss angle: Insulation resistance	$ \Delta C/C \leq 3\%$ compared to values measured in 4.13.1 Increase of $\tan \delta$: ≤ 0.003 for $C \leq 1 \mu\text{F}$ or ≤ 0.002 for $C > 1 \mu\text{F}$ ≤ 0.004 for $C \geq 100 \mu\text{F}$ Compared to values measured in 4.13.1 $\geq 50\%$ of values specified in section "Insulation Resistance" of this specification



Disclaimer

ALL PRODUCT, PRODUCT SPECIFICATIONS AND DATA ARE SUBJECT TO CHANGE WITHOUT NOTICE TO IMPROVE RELIABILITY, FUNCTION OR DESIGN OR OTHERWISE.

Vishay Intertechnology, Inc., its affiliates, agents, and employees, and all persons acting on its or their behalf (collectively, "Vishay"), disclaim any and all liability for any errors, inaccuracies or incompleteness contained in any datasheet or in any other disclosure relating to any product.

Vishay makes no warranty, representation or guarantee regarding the suitability of the products for any particular purpose or the continuing production of any product. To the maximum extent permitted by applicable law, Vishay disclaims (i) any and all liability arising out of the application or use of any product, (ii) any and all liability, including without limitation special, consequential or incidental damages, and (iii) any and all implied warranties, including warranties of fitness for particular purpose, non-infringement and merchantability.

Statements regarding the suitability of products for certain types of applications are based on Vishay's knowledge of typical requirements that are often placed on Vishay products in generic applications. Such statements are not binding statements about the suitability of products for a particular application. It is the customer's responsibility to validate that a particular product with the properties described in the product specification is suitable for use in a particular application. Parameters provided in datasheets and/or specifications may vary in different applications and performance may vary over time. All operating parameters, including typical parameters, must be validated for each customer application by the customer's technical experts. Product specifications do not expand or otherwise modify Vishay's terms and conditions of purchase, including but not limited to the warranty expressed therein.

Except as expressly indicated in writing, Vishay products are not designed for use in medical, life-saving, or life-sustaining applications or for any other application in which the failure of the Vishay product could result in personal injury or death. Customers using or selling Vishay products not expressly indicated for use in such applications do so at their own risk. Please contact authorized Vishay personnel to obtain written terms and conditions regarding products designed for such applications.

No license, express or implied, by estoppel or otherwise, to any intellectual property rights is granted by this document or by any conduct of Vishay. Product names and markings noted herein may be trademarks of their respective owners.

Material Category Policy

Vishay Intertechnology, Inc. hereby certifies that all its products that are identified as RoHS-Compliant fulfill the definitions and restrictions defined under Directive 2011/65/EU of The European Parliament and of the Council of June 8, 2011 on the restriction of the use of certain hazardous substances in electrical and electronic equipment (EEE) - recast, unless otherwise specified as non-compliant.

Please note that some Vishay documentation may still make reference to RoHS Directive 2002/95/EC. We confirm that all the products identified as being compliant to Directive 2002/95/EC conform to Directive 2011/65/EU.

Vishay Intertechnology, Inc. hereby certifies that all its products that are identified as Halogen-Free follow Halogen-Free requirements as per JEDEC JS709A standards. Please note that some Vishay documentation may still make reference to the IEC 61249-2-21 definition. We confirm that all the products identified as being compliant to IEC 61249-2-21 conform to JEDEC JS709A standards.

Компания «Океан Электроники» предлагает заключение долгосрочных отношений при поставках импортных электронных компонентов на взаимовыгодных условиях!

Наши преимущества:

- Поставка оригинальных импортных электронных компонентов напрямую с производств Америки, Европы и Азии, а так же с крупнейших складов мира;
- Широкая линейка поставок активных и пассивных импортных электронных компонентов (более 30 млн. наименований);
- Поставка сложных, дефицитных, либо снятых с производства позиций;
- Оперативные сроки поставки под заказ (от 5 рабочих дней);
- Экспресс доставка в любую точку России;
- Помощь Конструкторского Отдела и консультации квалифицированных инженеров;
- Техническая поддержка проекта, помощь в подборе аналогов, поставка прототипов;
- Поставка электронных компонентов под контролем ВП;
- Система менеджмента качества сертифицирована по Международному стандарту ISO 9001;
- При необходимости вся продукция военного и аэрокосмического назначения проходит испытания и сертификацию в лаборатории (по согласованию с заказчиком);
- Поставка специализированных компонентов военного и аэрокосмического уровня качества (Xilinx, Altera, Analog Devices, Intersil, Interpoint, Microsemi, Actel, Aeroflex, Peregrine, VPT, Syfer, Eurofarad, Texas Instruments, MS Kennedy, Miteq, Cobham, E2V, MA-COM, Hittite, Mini-Circuits, General Dynamics и др.);

Компания «Океан Электроники» является официальным дистрибьютором и эксклюзивным представителем в России одного из крупнейших производителей разъемов военного и аэрокосмического назначения «JONHON», а так же официальным дистрибьютором и эксклюзивным представителем в России производителя высокотехнологичных и надежных решений для передачи СВЧ сигналов «FORSTAR».



JONHON

«JONHON» (основан в 1970 г.)

Разъемы специального, военного и аэрокосмического назначения:

(Применяются в военной, авиационной, аэрокосмической, морской, железнодорожной, горно- и нефтедобывающей отраслях промышленности)

«FORSTAR» (основан в 1998 г.)

ВЧ соединители, коаксиальные кабели,
кабельные сборки и микроволновые компоненты:

(Применяются в телекоммуникациях гражданского и специального назначения, в средствах связи, РЛС, а так же военной, авиационной и аэрокосмической отраслях промышленности).



Телефон: 8 (812) 309-75-97 (многоканальный)

Факс: 8 (812) 320-03-32

Электронная почта: ocean@oceanchips.ru

Web: <http://oceanchips.ru/>

Адрес: 198099, г. Санкт-Петербург, ул. Калинина, д. 2, корп. 4, лит. А