



Choose one component from each of the colored sections to assemble a complete switch.

Product Profile

The Series 04 is a high quality switch range that includes pushbuttons, indicators, selectors, mushroom headed switches, key switches, and Emergency-stops.

Options include self cleaning, slow-make and snap-action switching elements.

Technical drawings see pages 18-21

- IP65 Protection
- Switch Rating:
Maximum Voltage, 600VAC
Maximum Thermal Current, $I_{th} = 10A$
230VAC/6A, 24VDC/10A
- Raised Mounting into 22.5mm cut out
- Flush Mounting into 30.5mm cut out
- Illumination using Ba9s (T-3¼ bayonet base) Lamps or LED's
- All standard lenses are transparent with translucent diffuser
- Screw terminal or plug-in connections

Indicator



Indicator, round, full face, 22.5mm mounting

| Color | Part No. |
|--------|-----------|
| Red | 704.000.2 |
| Yellow | 704.000.4 |
| Green | 704.000.5 |
| Blue | 704.000.6 |
| Clear | 704.000.7 |

For complete switch also order



Indicator, flush mount, aluminum bezel, 30.5mm mounting

| Color | Part No. |
|--------|-------------|
| Red | 704.006.218 |
| Yellow | 704.006.418 |
| Green | 704.006.518 |
| Blue | 704.006.618 |
| Clear | 704.006.718 |

For complete switch also order

Non-illuminated pushbutton



Non illuminated raised pushbutton, gray plastic bezel, 22.5mm mounting



Non illuminated raised pushbutton, aluminum bezel, 22.5mm mounting



Non illuminated flush mount pushbutton, aluminum bezel, 30.5mm mounting

| Part Ordering System 704.02 - () () () () | | Front Ring | | Diffuser Type | Lens/Cap Color |
|---|------------------|------------|-----------------|---------------------------|----------------|
| Pushbutton Action | Lens/Cap Style | Style | Material | | |
| 1-Momentary | Standard-plastic | 0-Standard | Black plastic | 0-Black | 0-Black |
| 2-Momentary | Standard-metal | 1-Standard | Anodized Al | 1-No diffuser | 2-Red |
| 3-Momentary | Extended-plastic | 2-Sealed | Ni plated brass | (Mushroom or opaque lens) | 3-Orange* |
| 4-Momentary | Mushroom-plastic | | Silicone cover | 7-Clear | 4-Yellow |
| 5-Maintained | Standard-plastic | 3-Sealed | Anodized Al | 9-White | 5-Green |
| 6-Maintained | Standard-metal | | Silicon cover | | 6-Blue** |
| 7-Maintained | Extended-plastic | 4-Standard | Chrome plastic | | 7-White *** |
| 8-Maintained | Mushroom-plastic | 6-Standard | Gray plastic | | 8-Aluminum** |
| | | 7-Extended | Gray plastic | | 9-Steel** |
| | | 9-Standard | Steel | | |

| Color | Part No., Momentary | Part No., Maintained |
|--------|---------------------|----------------------|
| Red | 704.012.218 | 704.042.218 |
| Yellow | 704.012.418 | 704.042.418 |
| Green | 704.012.518 | 704.042.518 |
| Blue | 704.012.618 | 704.042.618 |
| Clear | 704.012.718 | 704.042.718 |
| Black | 704.012.018 | 704.042.218 |

For complete switch also order **A**

* Only available in standard plastic

** Not available with mushroom cap

*** Combination of clear lens and white diffuser

For complete switch also order **A**

Choose one component from each of the colored sections to assemble a complete switch.
For other options or further information please contact EAO Switch directly.



⊙ Illuminated pushbutton



Illuminated raised pushbutton, gray plastic bezel, 22.5mm mounting



Illuminated raised pushbutton, aluminum bezel, 22.5mm mounting



Illuminated flush mount pushbutton, aluminum bezel, 30.5mm mounting

| Part Ordering System 704.01 - () () () () | | | | | |
|---|------------|-------------------|---------------------|-----------------|--|
| Pushbutton Action | Lens Style | Termination Style | Front Ring Material | | Diffuser* Type |
| 1-Momentary | Standard | Screw | 0-Standard | Black plastic | 7-Clear |
| 2-Momentary | Standard | 0.250" Q.C. | 1-Standard | Anodized Al | 9-White |
| 3-Momentary | Extended | Screw | 2-Sealed | Ni plated brass | |
| 4-Momentary | Extended | 0.250" Q.C. | | Silicon cover | |
| 5-Maintained | Standard | Screw | 3-Sealed | Anodized Al | |
| 6-Maintained | Standard | 0.250" Q.C. | | Silicon cover | 2-Transparent red |
| 7-Maintained | Extended | Screw | 4-Standard | Chrome plastic | 3-Transparent orange |
| 8-Maintained | Extended | 0.250" Q.C. | 6-Standard | Gray plastic | 4-Transparent yellow |
| 9-Momentary | Mushroom | Screw | 7-Extended | Gray plastic | 5-Transparent green |
| 10-Momentary | Mushroom | 0.250" Q.C. | 9-Standard | Steel | 6-Transparent blue |
| 11-Maintained | Mushroom | Screw | | | 7-White (uses clear lens/white diffuser) |
| 12-Maintained | Mushroom | 0.250" Q.C. | | | |

| Color | Part No., Momentary | Part No., Maintained |
|----------|---------------------|----------------------|
| ● Red | 704.032.218 | 704.062.218 |
| ● Yellow | 704.032.418 | 704.062.418 |
| ● Green | 704.032.518 | 704.062.518 |
| ● Blue | 704.032.618 | 704.062.618 |
| ○ Clear | 704.032.718 | 704.062.718 |

For complete switch also order **A** *White translucent for incandescent lamps and clear knurled for neon

For complete switch also order **A**

⊙ Illuminated pushbutton



Illuminated raised pushbutton, gray plastic bezel, 22.5mm mounting



Illuminated raised pushbutton, aluminum bezel, 22.5mm mounting

| Part Ordering System 704.03 - () () () () | | | | | |
|---|----------------------|-------------|-------------------------------------|--------------|------------|
| Pushbutton Action | Lighted or Unlighted | Film Insert | Lamp Holder | Bezel Color | Lens Color |
| 0-Momentary | Lighted | With | 0-No lamp holder | 0-Black | 0-Black |
| 1-Momentary | Lighted | Without | 1-Lamp holder screw terminals | 4-Chrome | 2-Red |
| 2-Momentary | Unlighted | With | 2-Lamp holder 0.250" Q.C. terminals | 6-Light gray | 3-Orange |
| 3-Momentary | Unlighted | Without | | | 4-Yellow |
| 4-Maintained | Lighted | With | | | 5-Green |
| 5-Maintained | Lighted | Without | | | 6-Blue |
| 6-Maintained | Unlighted | With | | | 7-White* |
| 7-Maintained | Unlighted | Without | | | |

For complete switch also order **A** *Combination of clear lens and white diffuser





Choose one component from each of the colored sections to assemble a complete switch.

Emergency-stop switch



Emergency-stop, twist release, 37mm diameter, foolproof to EN 60947-5-1 and EN 418, use slow-make switching elements

| Part No. |
|-----------|
| 704.064.2 |

For emergency stop applications, a maximum of 2 switching elements can be used



Emergency-stop, key release, 37mm diameter, foolproof to EN 60947-5-1 and EN 418, use slow-make switching elements

| Part No. |
|-----------|
| 704.066.2 |

For emergency stop applications, a maximum of 2 switching elements can be used



Emergency-stop, twist release, mushroom head, 40mm diameter, use slow-make switching elements

| Part No. | Front Ring | Markings |
|-----------|-------------------|--------------------|
| 704.074.2 | Gray plastic | Directional arrows |
| 704.075.2 | Anodized aluminum | Directional arrows |

For complete switch also order **A**

For complete switch also order **A**

Mushroom headed pushbutton



Mushroom headed pushbutton, plastic bezel and aluminum bezel, 22.5mm mounting, function momentary

| Color | Part No., Plastic | Part No., Aluminum |
|--------|-------------------|--------------------|
| Red | 704.070.2 | 704.071.2 |
| Yellow | 704.070.4 | 704.071.4 |
| Green | 704.070.5 | 704.071.5 |
| Black | 704.070.0 | 704.071.0 |

Maintained versions available as well

For complete switch also order **A**

Keylock switch



Keylock switch 2 position, raised, 22.5mm mounting

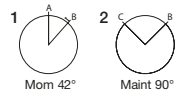

| Drawing | Part No. | Action | Key rem. |
|---------|-----------|------------|----------|
| 1 | 704.123.0 | Momentary | A |
| 2 | 704.121.0 | Maintained | C |



Keylock switch 2 position, flush mount, 30.5mm mounting

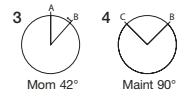

| Drawing | Part No. | Action | Key rem. |
|---------|-------------|------------|----------|
| 3 | 704.123.018 | Momentary | A |
| 4 | 704.121.018 | Maintained | C |

For complete switch also order **A**

Choose one component from each of the colored sections to assemble a complete switch.
For other options or further information please contact EAO Switch directly.

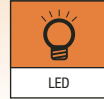

Keylock switch **Selector switch**



Keylock switch 3 position, raised, 22.5mm mounting

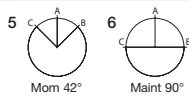

Keylock switch 3 position, flush mount, 30.5mm mounting

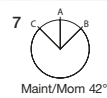

Selector switch short lever 2 position, raised, 22.5mm mounting

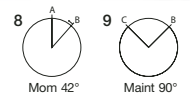

| Drawing | Part No. | Action | Key rem. |
|---------|-----------|-----------------------|----------|
| 5 | 704.115.0 | Momentary/Momentary | A |
| 6 | 704.114.0 | Maintained/Maintained | A |
| | | | |
| | | | |
| | | | |
| | | | |

| Drawing | Part No. | Action | Key rem. |
|---------|-------------|-----------------------|----------|
| 7 | 704.115.018 | Momentary/Momentary | A |
| 7 | 704.114.018 | Maintained/Maintained | A |
| | | | |
| | | | |
| | | | |
| | | | |

| Drawing | Part No. | Action | Bezel |
|---------|-----------|------------|--------------|
| 8 | 704.412.0 | Momentary | Gray plastic |
| 8 | 704.413.0 | Momentary | Aluminum |
| 9 | 704.410.0 | Maintained | Gray plastic |
| 9 | 704.411.0 | Maintained | Aluminum |
| | | | |
| | | | |

For complete switch also order **A**

For complete switch also order **A**

For complete switch also order **A**

Selector switch



Selector switch short lever 2 position, flush mount, 30.5mm mounting

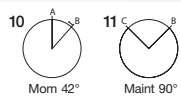

Selector switch short lever 3 position, raised, 22.5mm mounting

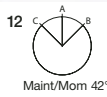

Selector switch short lever 3 position, flush mount, 30.5mm mounting

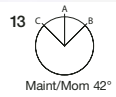

| Drawing | Part No. | Action | Bezel |
|---------|-------------|------------|----------|
| 10 | 704.413.018 | Momentary | Aluminum |
| 11 | 704.411.018 | Maintained | Aluminum |
| | | | |
| | | | |
| | | | |
| | | | |

| Drawing | Part No. | Action | Bezel |
|---------|-----------|-----------------------|--------------|
| 12 | 704.404.0 | Momentary/Momentary | Gray plastic |
| 12 | 704.405.0 | Momentary/Momentary | Aluminum |
| 12 | 704.402.0 | Maintained/Maintained | Gray plastic |
| 12 | 704.403.0 | Maintained/Maintained | Aluminum |
| | | | |
| | | | |

| Drawing | Part No. | Action | Bezel |
|---------|-------------|------------|----------|
| 13 | 704.405.018 | Momentary | Aluminum |
| 13 | 704.403.018 | Maintained | Aluminum |
| | | | |
| | | | |
| | | | |
| | | | |

For complete switch also order **A**

For complete switch also order **A**

For complete switch also order **A**



Choose one component from each of the colored sections to assemble a complete switch.

Selector switch



Selector switch long lever 2 position, raised, 22.5mm mounting

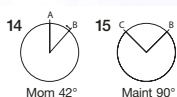

Selector switch long lever 2 position, flush mount, 30.5mm mounting

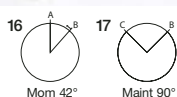

Selector switch long lever 3 position, raised, 22.5mm mounting

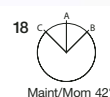

| Drawing | Part No. | Action | Bezel |
|---------|-----------|------------|--------------|
| 14 | 704.102.0 | Momentary | Gray plastic |
| 14 | 704.103.0 | Momentary | Aluminum |
| 15 | 704.100.0 | Maintained | Gray plastic |
| 15 | 704.101.0 | Maintained | Aluminum |

| Drawing | Part No. | Action | Bezel |
|---------|-------------|------------|----------|
| 16 | 704.103.018 | Momentary | Aluminum |
| 17 | 704.101.018 | Maintained | Aluminum |

| Drawing | Part No. | Action | Bezel |
|---------|-----------|------------|--------------|
| 18 | 704.094.0 | Momentary | Gray plastic |
| 18 | 704.095.0 | Momentary | Aluminum |
| 18 | 704.092.0 | Maintained | Gray plastic |
| 18 | 704.093.0 | Maintained | Aluminum |

For complete switch also order **A**

For complete switch also order **A**

For complete switch also order **A**

Selector switch



Selector switch long lever 3 position, flush mount, 30.5mm mounting

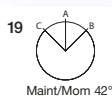

Buzzer



Buzzer, plastic bezel, raised, 22.5mm mounting, 24VDC, 95dB ± 8 at a distance of 0.1m



Buzzer, plastic bezel, flush mount, 30.5mm mounting, 24VDC, IP40, 95dB ± 8 at a distance of 0.1m

| Drawing | Part No. | Action | Bezel |
|---------|-------------|------------|----------|
| 19 | 704.095.018 | Momentary | Aluminum |
| 19 | 704.093.018 | Maintained | Aluminum |

| Part No. | Front finish |
|------------|-----------------|
| 14-810.002 | Black plastic |
| 14-810.902 | Chromium-plated |

| Part No. | Front finish |
|------------|-----------------|
| 14-810.910 | Black plastic |
| 14-810.918 | Chromium-plated |

For complete switch also order **A**

Choose one component from each of the colored sections to assemble a complete switch.
For other options or further information please contact EAO Switch directly.

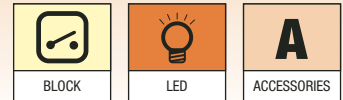

Contact block



Contact block, screw terminal, snap-action with silver self-cleaning contacts

| Part No. | Contact type |
|-----------------------------|--------------|
| 704.900.1 | 1NO |
| 704.900.2 | 1NC |
| 704.900.3 | 2NO |
| 704.900.4 | 2NC |
| 704.900.5 | 1NO/1NC |
| Not recommended for | |
| Emergency-stop applications | |

For complete switch also order



Contact block, screw terminal, slow-make (positive-break) with silver forced opening contacts

| Part No. | Contact type |
|-----------|--------------|
| 704.910.2 | 1NC |
| 704.910.4 | 2NC |
| 704.910.5 | 1NO/1NC |
| 704.910.1 | 1NO |
| 704.910.2 | 2NO |

For complete switch also order

LED



LED, Ba9s (T-3¼ bayonet base), single chip, 6 Volt and 12 Volt

| Color | Part No. | Voltage |
|--------|--------------|----------------|
| Red | 10-2506.1082 | 6VDC, 17mA |
| Yellow | 10-2506.1084 | 6VDC, 17mA |
| Green | 10-2506.1085 | 6VDC, 17mA |
| Blue | 10-2506.1086 | 6VDC, 17mA |
| White | 10-2506.1089 | 6VDC, 17mA |
| Red | 10-2509.1142 | 12VAC/DC, 16mA |
| Yellow | 10-2509.1144 | 12VAC/DC, 16mA |
| Green | 10-2509.1145 | 12VAC/DC, 7mA |
| Blue | 10-2509.1146 | 12VAC/DC, 16mA |
| White | 10-2509.1149 | 12VAC/DC, 16mA |

LED



LED, Ba9s, single chip, (T-3¼ bayonet base) 24 Volt and 28 Volt

| Color | Part No. | Voltage |
|--------|--------------|----------------|
| Red | 10-2512.1142 | 24VAC/DC, 15mA |
| Yellow | 10-2512.1144 | 24VAC/DC, 15mA |
| Green | 10-2512.1145 | 24VAC/DC, 7mA |
| Blue | 10-2512.1146 | 24VAC/DC, 15mA |
| White | 10-2512.1149 | 24VAC/DC, 15mA |
| Red | 10-2513.1142 | 28VAC/DC, 13mA |
| Yellow | 10-2513.1144 | 28VAC/DC, 13mA |
| Green | 10-2513.1145 | 28VAC/DC, 7mA |
| Blue | 10-2513.1146 | 28VAC/DC, 13mA |
| White | 10-2513.1149 | 28VAC/DC, 13mA |



LED, Ba9s, (T-3¼ bayonet base) single chip, 48 Volt

| Color | Part No. | Voltage |
|--------|--------------|---------------|
| Red | 10-2519.1052 | 48VAC/DC, 8mA |
| Yellow | 10-2519.1054 | 48VAC/DC, 8mA |
| Green | 10-2519.1055 | 48VAC/DC, 4mA |
| Blue | 10-2519.1056 | 48VAC/DC, 8mA |
| White | 10-2519.1059 | 48VAC/DC, 8mA |



LED, Ba9s, (T-3¼ bayonet base) single chip, 130 Volt and 230 Volt

| Color | Part No. | Voltage |
|--------|--------------|--------------|
| Red | 10-2H24.2052 | 130VAC / 5mA |
| Yellow | 10-2H24.2054 | 130VAC / 5mA |
| Green | 10-2H24.2055 | 130VAC / 3mA |
| Blue | 10-2H24.2056 | 130VAC / 5mA |
| White | 10-2H24.2059 | 130VAC / 5mA |
| Red | 10-2H25.2042 | 230VAC / 3mA |
| Yellow | 10-2H25.2044 | 230VAC / 3mA |
| Green | 10-2H25.2045 | 230VAC / 2mA |
| Blue | 10-2H25.2046 | 230VAC / 3mA |
| White | 10-2H25.2049 | 230VAC / 3mA |



Choose one component from each of the colored sections to assemble a complete switch.

A Accessories

| <p>Lens cap, round, transparent, plastic for raised and flush indicators with bezel and pushbutton actuators</p> | | <p>Protective cover, raised pushbutton</p> | | <p>Protective front ring with silicon membrane for raised or flush mount pushbutton, natural anodized aluminum</p> | |
|--|-----------|--|--------------------------|--|-----------------------------------|
| Color | Part No. | Part No. | Comment | Part No. | Size |
| ● Red | 704.602.2 | 704.925.0 | for pushbuttons | 704.600.3 | 29mm Ø for raised pushbutton |
| ● Yellow | 704.602.4 | 704.925.3 | for selector with short | 704.955.3 | 35mm Ø for flush mount pushbutton |
| ● Green | 704.602.5 | | lever with "self return" | | |
| ● Blue | 704.602.6 | | | | |
| ○ Clear | 704.602.7 | | | | |
| <p>For complete lens also order diffuser 704.609.9 (see page 21)</p> | | | | | |

A Accessories

| <p>Emergency-stop protective shroud, yellow painted aluminum with 22.5mm mounting hole</p> | | <p>Emergency-stop switch label, 60mm diameter, English, French and German with adhesive backing</p> | | <p>Emergency-stop switch enclosure with 22.5mm mounting hole</p> | |
|--|-----------|---|-------|--|--|
| Part No. | Part No. | Markings | Image | Part No. | |
| Contact EAO Switch directly | 704.963.6 | Emergency stop | 1 | 704.945.0 | |
| | 704.963.5 | Not Aus | 2 | 704.945.6 | |
| | 704.963.7 | Arret D'urgence | | | |
| | 44-950 | Blank | | | |
| <p>90mm versions also available</p> | | | | | |

Choose one component from each of the colored sections to assemble a complete switch.
For other options or further information please contact EAO Switch directly.

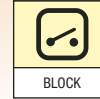

A Accessories



Blanking plate



Lens, LED and lamp remover

| Part No. | Mounting hole | Part No. | Part No. |
|-----------|---------------|-----------|-----------|
| 704.960.7 | 22.5mm Ø | 704.955.0 | 700.006.0 |
| 704.964.8 | 30.5mm Ø | 704.955.1 | |
| | | | |
| | | | |
| | | | |
| | | | |
| | | | |
| | | | |
| | | | |

A Accessories



Legend plate, adhesive, natural anodized aluminum finish for raised and flush mount pushbuttons

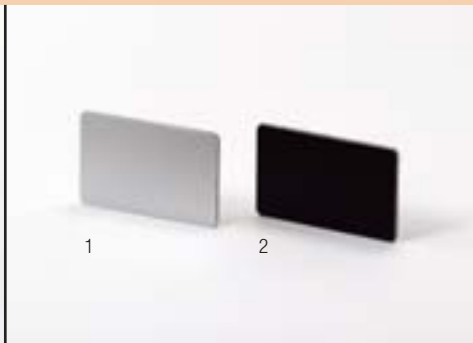

Label for front bezel set for 22.5 and 30.5mm flush mount with label support, self adhesive

| Image | Part No. | Mounting hole | Image | Part No. |
|-------|-----------|---------------|-------|-----------|
| 1 | 704.968.2 | 22.5mm Ø | 1 | 704.968.0 |
| 2 | 704.968.3 | 30.5mm Ø | 2 | 704.968.1 |
| | | | | |
| | | | | |
| | | | | |
| | | | | |
| | | | | |
| | | | | |
| | | | | |



04 Indicator

Raised

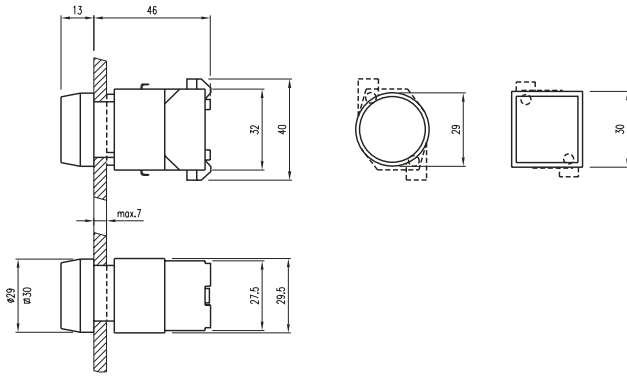

04 Indicator

Flush

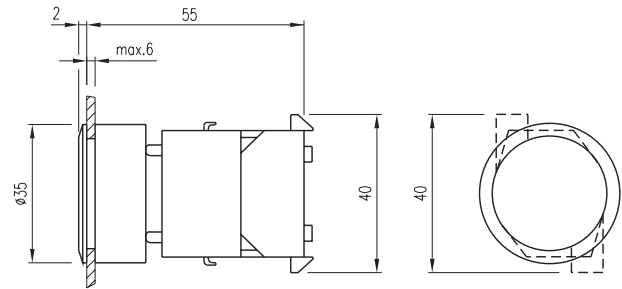

04 Pushbutton

Non-Illuminated, Raised

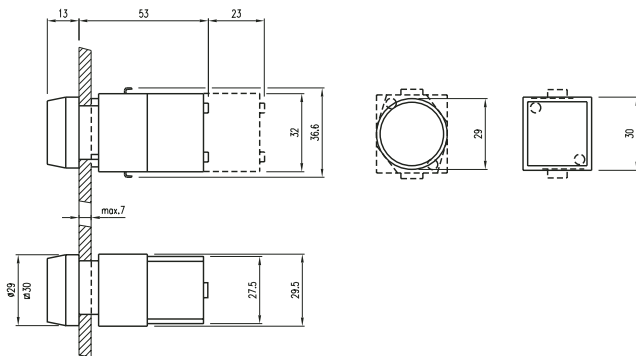

04 Pushbutton

Non-Illuminated, Flush

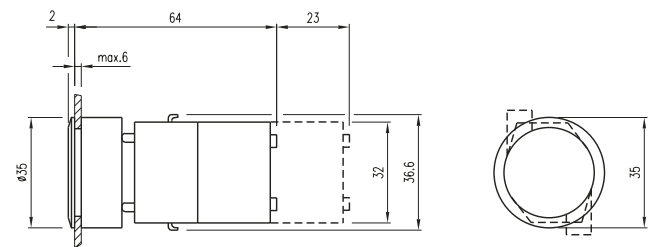

04 Pushbutton

Illuminated, Raised

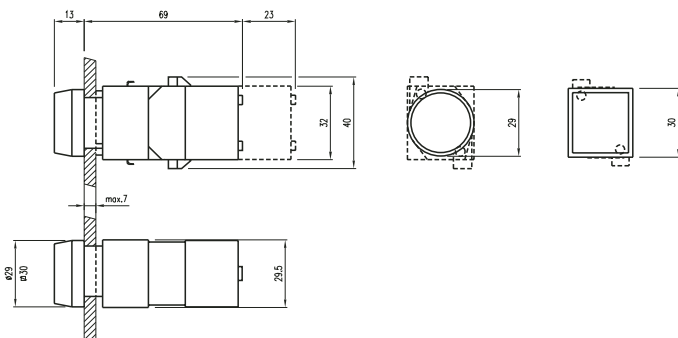

04 Pushbutton

Illuminated, Flush

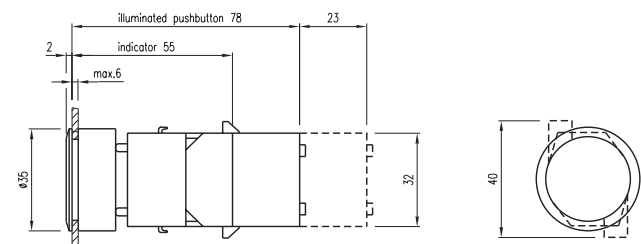

04 E-Stop

EN 418

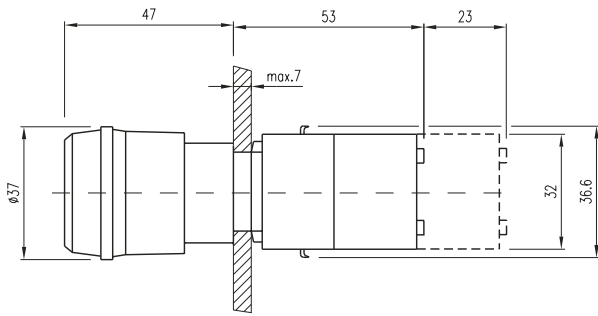

twist to release

04 E-Stop

EN 418 with optional key

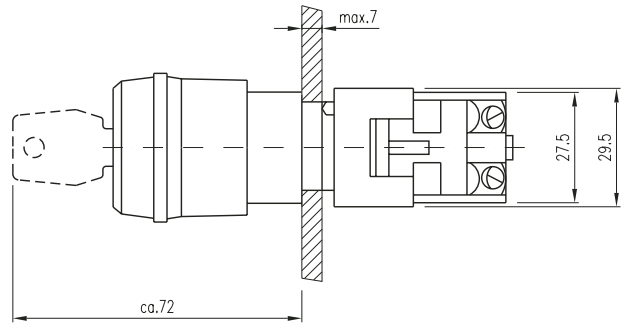

key to unlock

04 E-Stop Mushroom

Pushbutton Mushroom

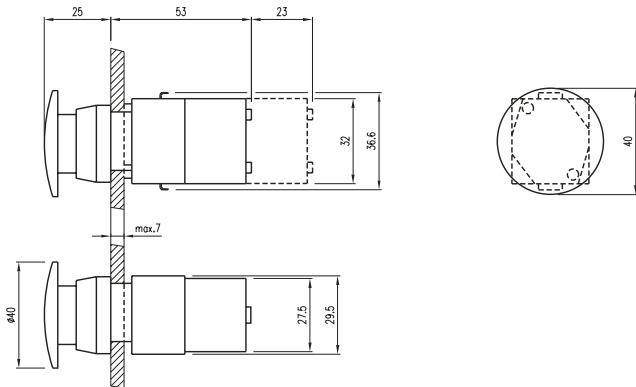

04 Keylock

2-Position, 3-Position, Raised

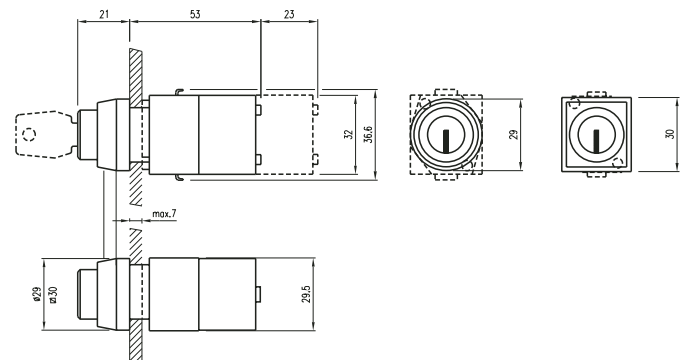

04 Keylock

2-Position, 3-Position, Flush

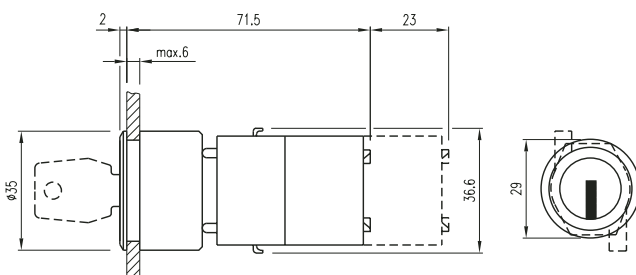

04 Selector

2-Position, 3-Position, Short and Long, Flush

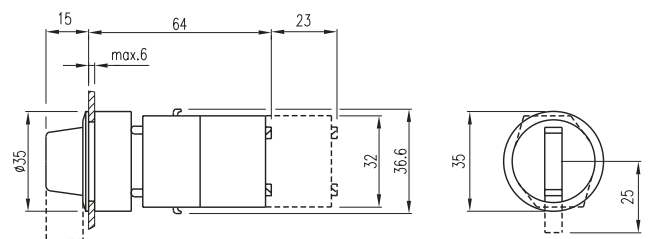

04 Selector, Short Lever

2-Position, 3-Position, Raised

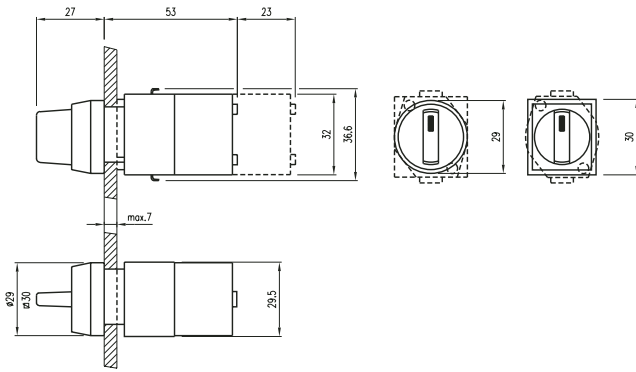

04 Selector, Long Lever

2-Position, 3-Position, Raised

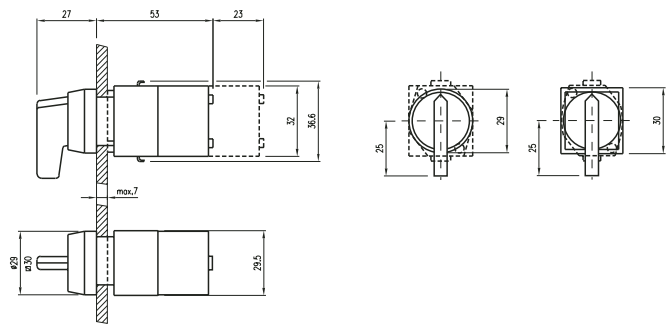

04 Buzzer

Raised

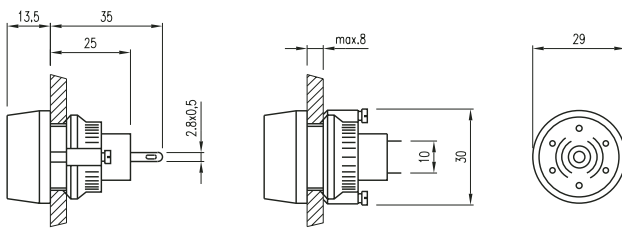

04 Buzzer

Flush

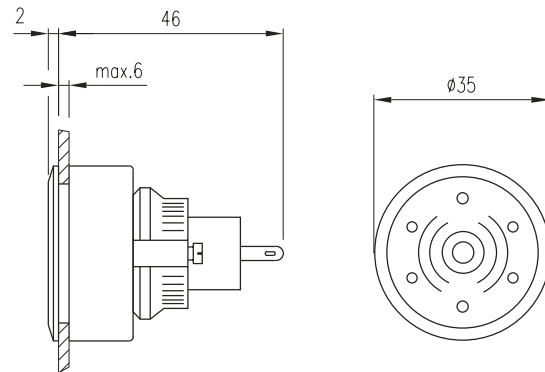

04 Cut-outs, Raised Mounting

(All but long lever)

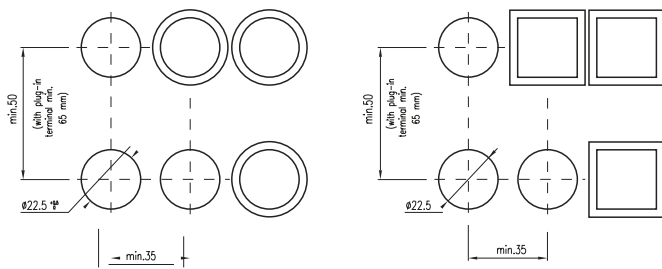

04 Cut-outs, Flush Mounting

(All but long lever)

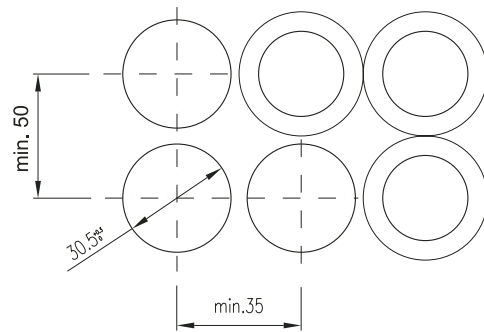

04 Long Lever Cut-outs, Raised Mounting

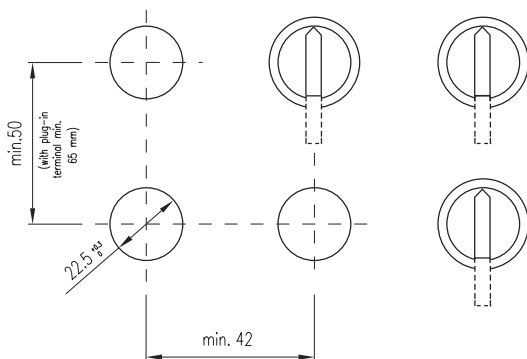

04 Long Lever Cut-outs, Flush Mounting

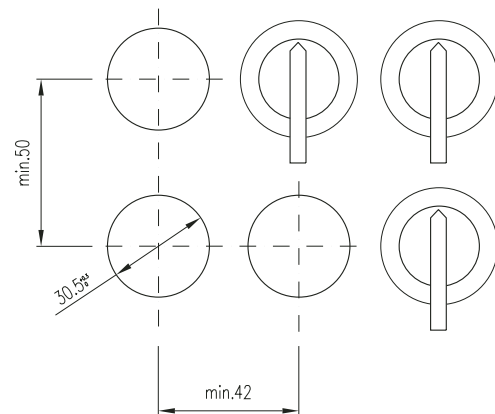

04 E-Stop EN418 Cut-outs

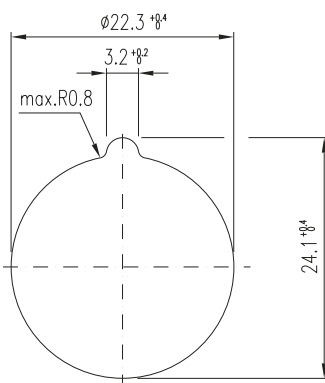

04 E-Stop Mushroom Cut-outs

Pushbutton Mushroom

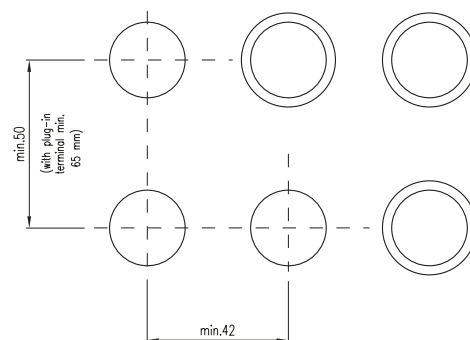

Компания «Океан Электроники» предлагает заключение долгосрочных отношений при поставках импортных электронных компонентов на взаимовыгодных условиях!

Наши преимущества:

- Поставка оригинальных импортных электронных компонентов напрямую с производств Америки, Европы и Азии, а так же с крупнейших складов мира;
- Широкая линейка поставок активных и пассивных импортных электронных компонентов (более 30 млн. наименований);
- Поставка сложных, дефицитных, либо снятых с производства позиций;
- Оперативные сроки поставки под заказ (от 5 рабочих дней);
- Экспресс доставка в любую точку России;
- Помощь Конструкторского Отдела и консультации квалифицированных инженеров;
- Техническая поддержка проекта, помощь в подборе аналогов, поставка прототипов;
- Поставка электронных компонентов под контролем ВП;
- Система менеджмента качества сертифицирована по Международному стандарту ISO 9001;
- При необходимости вся продукция военного и аэрокосмического назначения проходит испытания и сертификацию в лаборатории (по согласованию с заказчиком);
- Поставка специализированных компонентов военного и аэрокосмического уровня качества (Xilinx, Altera, Analog Devices, Intersil, Interpoint, Microsemi, Actel, Aeroflex, Peregrine, VPT, Syfer, Eurofarad, Texas Instruments, MS Kennedy, Miteq, Cobham, E2V, MA-COM, Hittite, Mini-Circuits, General Dynamics и др.);

Компания «Океан Электроники» является официальным дистрибьютором и эксклюзивным представителем в России одного из крупнейших производителей разъемов военного и аэрокосмического назначения «JONHON», а так же официальным дистрибьютором и эксклюзивным представителем в России производителя высокотехнологичных и надежных решений для передачи СВЧ сигналов «FORSTAR».



JONHON

«JONHON» (основан в 1970 г.)

Разъемы специального, военного и аэрокосмического назначения:

(Применяются в военной, авиационной, аэрокосмической, морской, железнодорожной, горно- и нефтедобывающей отраслях промышленности)

«FORSTAR» (основан в 1998 г.)

ВЧ соединители, коаксиальные кабели, кабельные сборки и микроволновые компоненты:

(Применяются в телекоммуникациях гражданского и специального назначения, в средствах связи, РЛС, а так же военной, авиационной и аэрокосмической отраслях промышленности).



Телефон: 8 (812) 309-75-97 (многоканальный)

Факс: 8 (812) 320-03-32

Электронная почта: ocean@oceanchips.ru

Web: <http://oceanchips.ru/>

Адрес: 198099, г. Санкт-Петербург, ул. Калинина, д. 2, корп. 4, лит. А