



Choose one component from each of the colored sections to assemble a complete switch.

## Product Profile

The Series 04 is a high quality switch range that includes pushbuttons, indicators, selectors, mushroom headed switches, key switches, and Emergency-stops.

Options include self cleaning, slow-make and snap-action switching elements.

Technical drawings see pages 18-21

- IP65 Protection
- Switch Rating:  
Maximum Voltage, 600VAC  
Maximum Thermal Current,  $I_{th} = 10A$   
230VAC/6A, 24VDC/10A
- Raised Mounting into 22.5mm cut out
- Flush Mounting into 30.5mm cut out
- Illumination using Ba9s (T-3¼ bayonet base) Lamps or LED's
- All standard lenses are transparent with translucent diffuser
- Screw terminal or plug-in connections

## Indicator



Indicator, round, full face, 22.5mm mounting

Color	Part No.
Red	704.000.2
Yellow	704.000.4
Green	704.000.5
Blue	704.000.6
Clear	704.000.7

For complete switch also order



Indicator, flush mount, aluminum bezel, 30.5mm mounting

Color	Part No.
Red	704.006.218
Yellow	704.006.418
Green	704.006.518
Blue	704.006.618
Clear	704.006.718

For complete switch also order

## Non-illuminated pushbutton



Non illuminated raised pushbutton, gray plastic bezel, 22.5mm mounting



Non illuminated raised pushbutton, aluminum bezel, 22.5mm mounting



Non illuminated flush mount pushbutton, aluminum bezel, 30.5mm mounting

Part Ordering System 704.02 - ( ) ( ) ( ) ( )		Front Ring		Diffuser Type	Lens/Cap Color
Pushbutton Action	Lens/Cap Style	Style	Material		
1-Momentary	Standard-plastic	0-Standard	Black plastic	0-Black	0-Black
2-Momentary	Standard-metal	1-Standard	Anodized Al	1-No diffuser	2-Red
3-Momentary	Extended-plastic	2-Sealed	Ni plated brass	(Mushroom or opaque lens)	3-Orange*
4-Momentary	Mushroom-plastic		Silicone cover	7-Clear	4-Yellow
5-Maintained	Standard-plastic	3-Sealed	Anodized Al	9-White	5-Green
6-Maintained	Standard-metal		Silicon cover		6-Blue**
7-Maintained	Extended-plastic	4-Standard	Chrome plastic		7-White ***
8-Maintained	Mushroom-plastic	6-Standard	Gray plastic		8-Aluminum**
		7-Extended	Gray plastic		9-Steel**
		9-Standard	Steel		

Color	Part No., Momentary	Part No., Maintained
Red	704.012.218	704.042.218
Yellow	704.012.418	704.042.418
Green	704.012.518	704.042.518
Blue	704.012.618	704.042.618
Clear	704.012.718	704.042.718
Black	704.012.018	704.042.218

For complete switch also order **A**

\* Only available in standard plastic

\*\* Not available with mushroom cap

\*\*\* Combination of clear lens and white diffuser

For complete switch also order **A**

Choose one component from each of the colored sections to assemble a complete switch.  
For other options or further information please contact EAO Switch directly.



**⊙ Illuminated pushbutton**



Illuminated raised pushbutton, gray plastic bezel, 22.5mm mounting



Illuminated raised pushbutton, aluminum bezel, 22.5mm mounting



Illuminated flush mount pushbutton, aluminum bezel, 30.5mm mounting

Part Ordering System 704.01 - ( ) ( ) ( ) ( )

Pushbutton Action	Lens Style	Termination Style	Front Ring Material	Diffuser* Type	Lens Color
1-Momentary	Standard	Screw	0-Standard	7-Clear	2-Transparent red
2-Momentary	Standard	0.250" Q.C.	1-Standard	9-White	3-Transparent orange
3-Momentary	Extended	Screw	2-Sealed		4-Transparent yellow
4-Momentary	Extended	0.250" Q.C.			5-Transparent green
5-Maintained	Standard	Screw	3-Sealed		6-Transparent blue
6-Maintained	Standard	0.250" Q.C.			7-White (uses clear lens/white diffuser)
7-Maintained	Extended	Screw	4-Standard		
8-Maintained	Extended	0.250" Q.C.	6-Standard		
9-Momentary	Mushroom	Screw	7-Extended		
10-Momentary	Mushroom	0.250" Q.C.	9-Standard		
11-Maintained	Mushroom	Screw			
12-Maintained	Mushroom	0.250" Q.C.			

Color	Part No., Momentary	Part No., Maintained
Red	704.032.218	704.062.218
Yellow	704.032.418	704.062.418
Green	704.032.518	704.062.518
Blue	704.032.618	704.062.618
Clear	704.032.718	704.062.718

For complete switch also order **A** \*White translucent for incandescent lamps and clear knurled for neon

For complete switch also order **A**

**⊙ Illuminated pushbutton**



Illuminated raised pushbutton, gray plastic bezel, 22.5mm mounting



Illuminated raised pushbutton, aluminum bezel, 22.5mm mounting

Part Ordering System 704.03 - ( ) ( ) ( ) ( )

Pushbutton Action	Lighted or Unlighted	Film Insert	Lamp Holder	Bezel Color	Lens Color
0-Momentary	Lighted	With	0-No lamp holder	0-Black	0-Black
1-Momentary	Lighted	Without	1-Lamp holder screw terminals	4-Chrome	2-Red
2-Momentary	Unlighted	With	2-Lamp holder 0.250" Q.C. terminals	6-Light gray	3-Orange
3-Momentary	Unlighted	Without			4-Yellow
4-Maintained	Lighted	With			5-Green
5-Maintained	Lighted	Without			6-Blue
6-Maintained	Unlighted	With			7-White*
7-Maintained	Unlighted	Without			

For complete switch also order **A** \*Combination of clear lens and white diffuser





Choose one component from each of the colored sections to assemble a complete switch.

## Emergency-stop switch



Emergency-stop, twist release, 37mm diameter, foolproof to EN 60947-5-1 and EN 418, use slow-make switching elements

Part No.
704.064.2

For emergency stop applications, a maximum of 2 switching elements can be used



Emergency-stop, key release, 37mm diameter, foolproof to EN 60947-5-1 and EN 418, use slow-make switching elements

Part No.
704.066.2

For emergency stop applications, a maximum of 2 switching elements can be used



Emergency-stop, twist release, mushroom head, 40mm diameter, use slow-make switching elements

Part No.	Front Ring	Markings
704.074.2	Gray plastic	Directional arrows
704.075.2	Anodized aluminum	Directional arrows

For complete switch also order **A**

For complete switch also order **A**

## Mushroom headed pushbutton



Mushroom headed pushbutton, plastic bezel and aluminum bezel, 22.5mm mounting, function momentary

Color	Part No., Plastic	Part No., Aluminum
Red	704.070.2	704.071.2
Yellow	704.070.4	704.071.4
Green	704.070.5	704.071.5
Black	704.070.0	704.071.0

Maintained versions available as well

For complete switch also order **A**

## Keylock switch



Keylock switch 2 position, raised, 22.5mm mounting

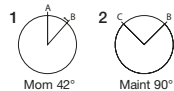

Drawing	Part No.	Action	Key rem.
1	704.123.0	Momentary	A
2	704.121.0	Maintained	C



Keylock switch 2 position, flush mount, 30.5mm mounting

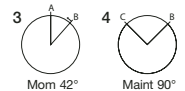







Drawing	Part No.	Action	Key rem.
3	704.123.018	Momentary	A
4	704.121.018	Maintained	C

For complete switch also order **A**

Choose one component from each of the colored sections to assemble a complete switch.  
For other options or further information please contact EAO Switch directly.







 BLOCK	 LED	 ACCESSORIES
---	---	---

Keylock switch				Selector switch							
											
Keylock switch 3 position, raised, 22.5mm mounting		Keylock switch 3 position, flush mount, 30.5mm mounting		Selector switch short lever 2 position, raised, 22.5mm mounting							
5		6		7		8		9			
	Mom 42°		Maint 90°		Maint/Mom 42°		Mom 42°		Maint 90°		
Drawing	Part No.	Action	Key rem.	Drawing	Part No.	Action	Key rem.	Drawing	Part No.	Action	Bezel
5	704.115.0	Momentary/Momentary	A	7	704.115.018	Momentary/Momentary	A	8	704.412.0	Momentary	Gray plastic
6	704.114.0	Maintained/Maintained	A	7	704.114.018	Maintained/Maintained	A	8	704.413.0	Momentary	Aluminum
								9	704.410.0	Maintained	Gray plastic
								9	704.411.0	Maintained	Aluminum

For complete switch also order  **A**

For complete switch also order  **A**

For complete switch also order  **A**

Selector switch											
											
Selector switch short lever 2 position, flush mount, 30.5mm mounting		Selector switch short lever 3 position, raised, 22.5mm mounting		Selector switch short lever 3 position, flush mount, 30.5mm mounting							
10		11		12		13					
	Mom 42°		Maint 90°		Maint/Mom 42°		Maint/Mom 42°				
Drawing	Part No.	Action	Bezel	Drawing	Part No.	Action	Bezel	Drawing	Part No.	Action	Bezel
10	704.413.018	Momentary	Aluminum	12	704.404.0	Momentary/Momentary	Gray plastic	13	704.405.018	Momentary	Aluminum
11	704.411.018	Maintained	Aluminum	12	704.405.0	Momentary/Momentary	Aluminum	13	704.403.018	Maintained	Aluminum
				12	704.402.0	Maintained/Maintained	Gray plastic				
				12	704.403.0	Maintained/Maintained	Aluminum				

For complete switch also order  **A**

For complete switch also order  **A**

For complete switch also order  **A**



Choose one component from each of the colored sections to assemble a complete switch.

## Selector switch



Selector switch long lever 2 position, raised, 22.5mm mounting



Selector switch long lever 2 position, flush mount, 30.5mm mounting



Selector switch long lever 3 position, raised, 22.5mm mounting

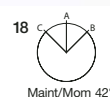

Drawing	Part No.	Action	Bezel
14	704.102.0	Momentary	Gray plastic
14	704.103.0	Momentary	Aluminum
15	704.100.0	Maintained	Gray plastic
15	704.101.0	Maintained	Aluminum

Drawing	Part No.	Action	Bezel
16	704.103.018	Momentary	Aluminum
17	704.101.018	Maintained	Aluminum

Drawing	Part No.	Action	Bezel
18	704.094.0	Momentary	Gray plastic
18	704.095.0	Momentary	Aluminum
18	704.092.0	Maintained	Gray plastic
18	704.093.0	Maintained	Aluminum

For complete switch also order **A**

For complete switch also order **A**

For complete switch also order **A**

## Selector switch



Selector switch long lever 3 position, flush mount, 30.5mm mounting



## Buzzer



Buzzer, plastic bezel, raised, 22.5mm mounting, 24VDC, 95dB ± 8 at a distance of 0.1m



Buzzer, plastic bezel, flush mount, 30.5mm mounting, 24VDC, IP40, 95dB ± 8 at a distance of 0.1m

Drawing	Part No.	Action	Bezel
19	704.095.018	Momentary	Aluminum
19	704.093.018	Maintained	Aluminum

Part No.	Front finish
14-810.002	Black plastic
14-810.902	Chromium-plated

Part No.	Front finish
14-810.910	Black plastic
14-810.918	Chromium-plated

For complete switch also order **A**

Choose one component from each of the colored sections to assemble a complete switch.  
For other options or further information please contact EAO Switch directly.

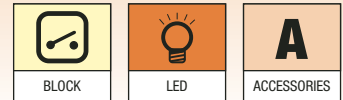

**Contact block**



Contact block, screw terminal, snap-action with silver self-cleaning contacts

Part No.	Contact type
704.900.1	1NO
704.900.2	1NC
704.900.3	2NO
704.900.4	2NC
704.900.5	1NO/1NC
Not recommended for Emergency-stop applications	

For complete switch also order



Contact block, screw terminal, slow-make (positive-break) with silver forced opening contacts

Part No.	Contact type
704.910.2	1NC
704.910.4	2NC
704.910.5	1NO/1NC
704.910.1	1NO
704.910.2	2NO

For complete switch also order

**LED**



LED, Ba9s (T-3¼ bayonet base), single chip, 6 Volt and 12 Volt

Color	Part No.	Voltage
Red	10-2506.1082	6VDC, 17mA
Yellow	10-2506.1084	6VDC, 17mA
Green	10-2506.1085	6VDC, 17mA
Blue	10-2506.1086	6VDC, 17mA
White	10-2506.1089	6VDC, 17mA
Red	10-2509.1142	12VAC/DC, 16mA
Yellow	10-2509.1144	12VAC/DC, 16mA
Green	10-2509.1145	12VAC/DC, 7mA
Blue	10-2509.1146	12VAC/DC, 16mA
White	10-2509.1149	12VAC/DC, 16mA

**LED**



LED, Ba9s, single chip, (T-3¼ bayonet base) 24 Volt and 28 Volt

Color	Part No.	Voltage
Red	10-2512.1142	24VAC/DC, 15mA
Yellow	10-2512.1144	24VAC/DC, 15mA
Green	10-2512.1145	24VAC/DC, 7mA
Blue	10-2512.1146	24VAC/DC, 15mA
White	10-2512.1149	24VAC/DC, 15mA
Red	10-2513.1142	28VAC/DC, 13mA
Yellow	10-2513.1144	28VAC/DC, 13mA
Green	10-2513.1145	28VAC/DC, 7mA
Blue	10-2513.1146	28VAC/DC, 13mA
White	10-2513.1149	28VAC/DC, 13mA



LED, Ba9s, (T-3¼ bayonet base) single chip, 48 Volt

Color	Part No.	Voltage
Red	10-2519.1052	48VAC/DC, 8mA
Yellow	10-2519.1054	48VAC/DC, 8mA
Green	10-2519.1055	48VAC/DC, 4mA
Blue	10-2519.1056	48VAC/DC, 8mA
White	10-2519.1059	48VAC/DC, 8mA



LED, Ba9s, (T-3¼ bayonet base) single chip, 130 Volt and 230 Volt

Color	Part No.	Voltage
Red	10-2H24.2052	130VAC / 5mA
Yellow	10-2H24.2054	130VAC / 5mA
Green	10-2H24.2055	130VAC / 3mA
Blue	10-2H24.2056	130VAC / 5mA
White	10-2H24.2059	130VAC / 5mA
Red	10-2H25.2042	230VAC / 3mA
Yellow	10-2H25.2044	230VAC / 3mA
Green	10-2H25.2045	230VAC / 2mA
Blue	10-2H25.2046	230VAC / 3mA
White	10-2H25.2049	230VAC / 3mA



Choose one component from each of the colored sections to assemble a complete switch.

## A Accessories



Lens cap, round, transparent, plastic for raised and flush indicators with bezel and pushbutton actuators

Protective cover, raised pushbutton

Protective front ring with silicon membrane for raised or flush mount pushbutton, natural anodized aluminum

Color	Part No.	Part No.	Comment	Part No.	Size
● Red	704.602.2	704.925.0	for pushbuttons	704.600.3	29mm Ø for raised pushbutton
● Yellow	704.602.4	704.925.3	for selector with short lever with "self return"	704.955.3	35mm Ø for flush mount pushbutton
● Green	704.602.5				
● Blue	704.602.6				
○ Clear	704.602.7				
For complete lens also order diffuser 704.609.9 (see page 21)					

## A Accessories



Emergency-stop protective shroud, yellow painted aluminum with 22.5mm mounting hole

Emergency-stop switch label, 60mm diameter, English, French and German with adhesive backing

Emergency-stop switch enclosure with 22.5mm mounting hole

Part No.	Part No.	Markings	Image	Part No.
Contact EAO Switch directly	704.963.6	Emergency stop	1	704.945.0
	704.963.5	Not Aus	2	704.945.6
	704.963.7	Arret D'urgence		
	44-950	Blank		
90mm versions also available				

Choose one component from each of the colored sections to assemble a complete switch.  
For other options or further information please contact EAO Switch directly.



**A Accessories**



Blanking plate



Lens, LED and lamp remover

Part No.	Mounting hole	Part No.	Part No.
704.960.7	22.5mm Ø	704.955.0	700.006.0
704.964.8	30.5mm Ø	704.955.1	

**A Accessories**



Legend plate, adhesive, natural anodized aluminum finish for raised and flush mount pushbuttons

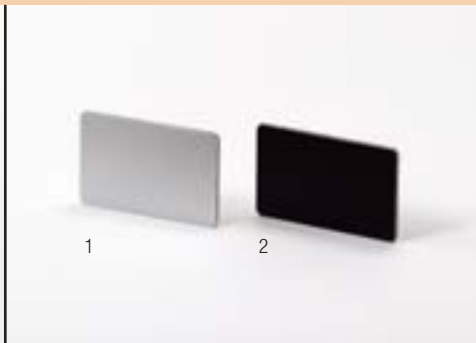

Label for front bezel set for 22.5 and 30.5mm flush mount with label support, self adhesive

Image	Part No.	Mounting hole	Image	Part No.
1	704.968.2	22.5mm Ø	1	704.968.0
2	704.968.3	30.5mm Ø	2	704.968.1





## 04 Indicator

Raised



## 04 Indicator

Flush



## 04 Pushbutton

Non-Illuminated, Raised



## 04 Pushbutton

Non-Illuminated, Flush



## 04 Pushbutton

Illuminated, Raised



## 04 Pushbutton

Illuminated, Flush



## 04 E-Stop

EN 418

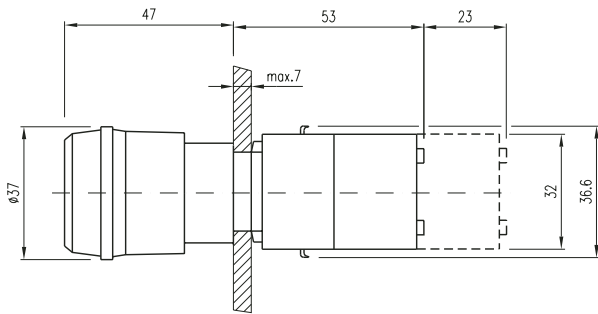

twist to release

## 04 E-Stop

EN 418 with optional key



key to unlock

## 04 E-Stop Mushroom

Pushbutton Mushroom



## 04 Keylock

2-Position, 3-Position, Raised



## 04 Keylock

2-Position, 3-Position, Flush



## 04 Selector

2-Position, 3-Position, Short and Long, Flush



## 04 Selector, Short Lever

2-Position, 3-Position, Raised



## 04 Selector, Long Lever

2-Position, 3-Position, Raised

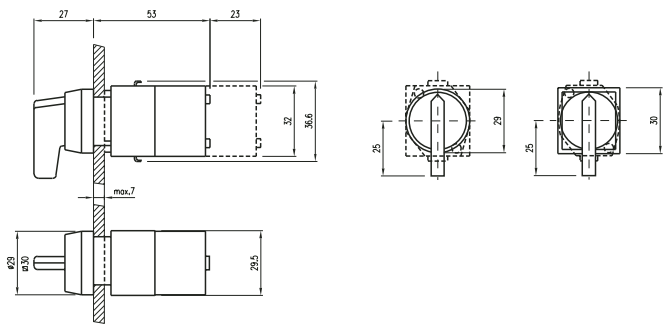

## 04 Buzzer

Raised



## 04 Buzzer

Flush



## 04 Cut-outs, Raised Mounting

(All but long lever)

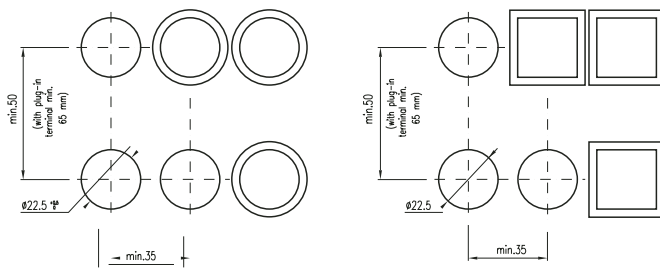

## 04 Cut-outs, Flush Mounting

(All but long lever)

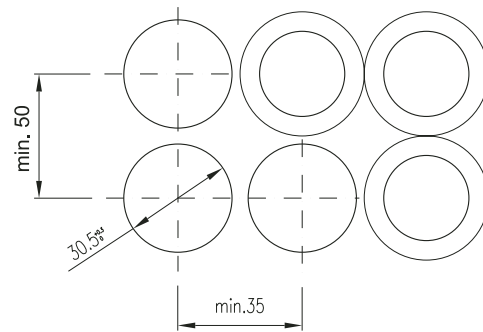

## 04 Long Lever Cut-outs, Raised Mounting



## 04 Long Lever Cut-outs, Flush Mounting

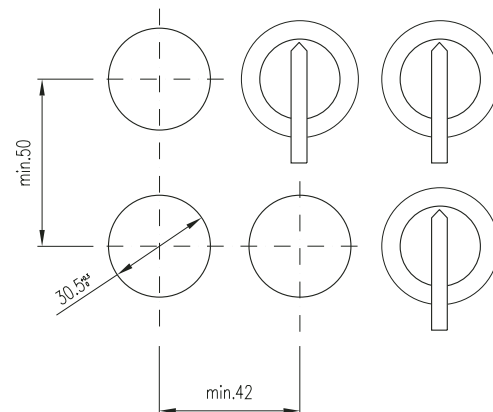

## 04 E-Stop EN418 Cut-outs



## 04 E-Stop Mushroom Cut-outs

Pushbutton Mushroom

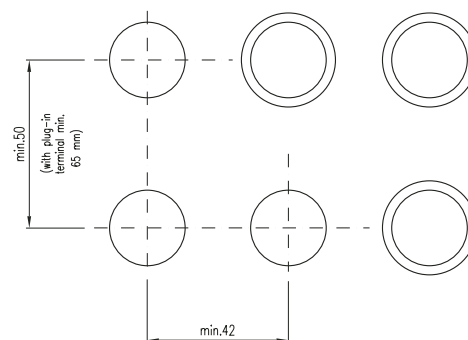

Компания «Океан Электроники» предлагает заключение долгосрочных отношений при поставках импортных электронных компонентов на взаимовыгодных условиях!

Наши преимущества:

- Поставка оригинальных импортных электронных компонентов напрямую с производств Америки, Европы и Азии, а так же с крупнейших складов мира;
- Широкая линейка поставок активных и пассивных импортных электронных компонентов (более 30 млн. наименований);
- Поставка сложных, дефицитных, либо снятых с производства позиций;
- Оперативные сроки поставки под заказ (от 5 рабочих дней);
- Экспресс доставка в любую точку России;
- Помощь Конструкторского Отдела и консультации квалифицированных инженеров;
- Техническая поддержка проекта, помощь в подборе аналогов, поставка прототипов;
- Поставка электронных компонентов под контролем ВП;
- Система менеджмента качества сертифицирована по Международному стандарту ISO 9001;
- При необходимости вся продукция военного и аэрокосмического назначения проходит испытания и сертификацию в лаборатории (по согласованию с заказчиком);
- Поставка специализированных компонентов военного и аэрокосмического уровня качества (Xilinx, Altera, Analog Devices, Intersil, Interpoint, Microsemi, Actel, Aeroflex, Peregrine, VPT, Syfer, Eurofarad, Texas Instruments, MS Kennedy, Miteq, Cobham, E2V, MA-COM, Hittite, Mini-Circuits, General Dynamics и др.);

Компания «Океан Электроники» является официальным дистрибьютором и эксклюзивным представителем в России одного из крупнейших производителей разъемов военного и аэрокосмического назначения «JONHON», а так же официальным дистрибьютором и эксклюзивным представителем в России производителя высокотехнологичных и надежных решений для передачи СВЧ сигналов «FORSTAR».



## JONHON

«JONHON» (основан в 1970 г.)

Разъемы специального, военного и аэрокосмического назначения:

(Применяются в военной, авиационной, аэрокосмической, морской, железнодорожной, горно- и нефтедобывающей отраслях промышленности)

«FORSTAR» (основан в 1998 г.)

ВЧ соединители, коаксиальные кабели,  
кабельные сборки и микроволновые компоненты:

(Применяются в телекоммуникациях гражданского и специального назначения, в средствах связи, РЛС, а так же военной, авиационной и аэрокосмической отраслях промышленности).



Телефон: 8 (812) 309-75-97 (многоканальный)

Факс: 8 (812) 320-03-32

Электронная почта: [ocean@oceanchips.ru](mailto:ocean@oceanchips.ru)

Web: <http://oceanchips.ru/>

Адрес: 198099, г. Санкт-Петербург, ул. Калинина, д. 2, корп. 4, лит. А