

ASMB-MTBO-0A3A2

PLCC4 Tricolor Black Surface LED



Data Sheet



Lead (Pb) Free
RoHS 6 fully
compliant



Description

For easy pick & place, the LEDs are shipped in EIA-compliant tape and reel. Every reel is shipped from a single intensity and color bin; except red color for better uniformity.

These LEDs are compatible with the reflow soldering process.

This super wide viewing angle at 115° together with the built-in reflector pushing up the intensity of the light output makes these LEDs suitable to be used in interior electronics signs.

The black top surface of the LED provides better contrast enhancement, especially in full color display.

Features

- Standard PLCC-4 package (Plastic Leaded Chip Carrier)
- LED package with diffused silicone encapsulation
- Using AlInGaP and InGaN dice technologies
- Typical viewing angle at 115°
- Compatible with reflow soldering process
- JEDEC MSL 3

Applications

- Indoor full color display

CAUTION: LEDs are ESD-sensitive. Please observe appropriate precautions during handling and processing. Refer to Avago Application Note AN-1142 for additional details.

Package Dimensions

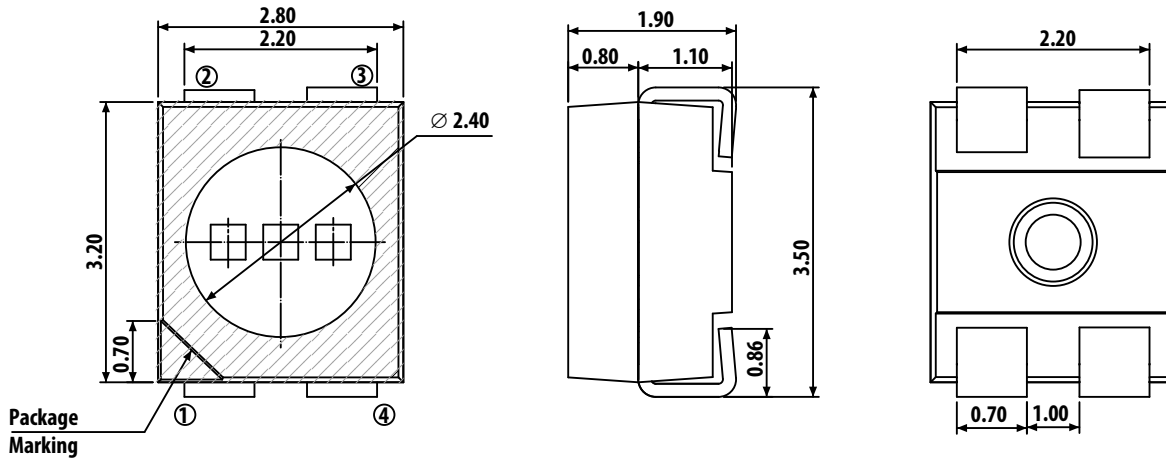

Notes:

1. All Dimensions are in millimeters
2. Tolerance = ± 0.2 mm, unless otherwise specified
3. Terminal Finish: Ag plating

Lead Configuration	
1	Common Anode
2	Cathode Blue
3	Cathode Green
4	Cathode Red

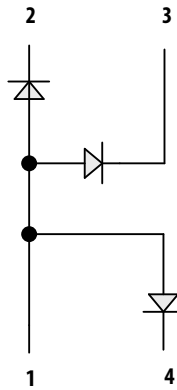

Part Numbering System

A S M B - M T B 0 - 0 X₂ X₃ X₄ X₅

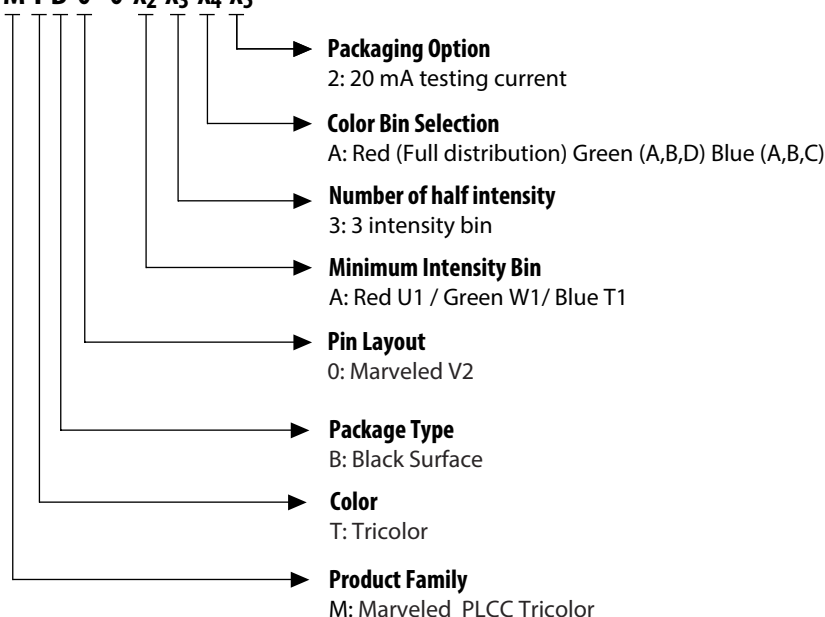

Table 1. Device Selection Guide

Parameter	Option Code	ASMB-MTBO-0A3A2		
		Red	Green	Blue
Intensity Bin	X ₂ X ₃ = A3	U1, U2, V1	W1, W2, X1	T1, T 2, U1
Color Bin	X ₄ = A	Full Range	A,B,D	A,B,C
Packaging Option	X ₅ = 2	Test Current: 20 mA		

Intensity Bin Limits

Bin ID	Min (mcd)	Max (mcd)
T1	285.0	355.0
T2	355.0	450.0
U1	450.0	560.0
U2	560.0	715.0
V1	715.0	900.0
V2	900.0	1125.0
W1	1125.0	1400.0
W2	1400.0	1800.0
X1	1800.0	2240.0

Tolerance of each bin limit $\pm 12\%$

Color Bin Limits

Red Color Bin Table

Bin ID	Dominant Wavelength		Chromaticity Coordinate				
	Min	Max	x	y	z	w	
Full range	619.0	629.0	x	0.6894	0.6752	0.6916	0.7066
			y	0.3104	0.3113	0.2950	0.2934

Tolerance of each bin limit is ± 1 nm

Green Color Bin Table

Bin ID	Dominant Wavelength		Chromaticity Coordinate				
	Min	Max	x	y	z	w	
A	525	531	x	0.1142	0.1624	0.2001	0.1625
			y	0.8262	0.7178	0.6983	0.8012
B	528	534	x	0.1387	0.1815	0.2179	0.1854
			y	0.8148	0.7089	0.687	0.7867
C	531	535	x	0.1625	0.2001	0.2238	0.1929
			y	0.8012	0.6983	0.683	0.7816

Tolerance of each bin limit is ± 1 nm

Blue Color Bin Table

Bin ID	Dominant Wavelength		Chromaticity Coordinate				
	Min	Max	x	y	z	w	
A	465	469	x	0.1355	0.1751	0.1680	0.1267
			y	0.0399	0.0986	0.1094	0.0534
B	467	471	x	0.1314	0.1718	0.1638	0.1215
			y	0.0459	0.1034	0.1167	0.0626
C	469	473	x	0.1267	0.168	0.1593	0.1158
			y	0.0534	0.1094	0.1255	0.0736

Tolerance of each bin limit is ± 1 nm

Table 2. Absolute Maximum Ratings ($T_A = 25\text{ }^\circ\text{C}$)

Parameter	Red	Green and Blue	Unit
DC forward current [1]	25	25	mA
Peak forward current [2]	100	100	mA
Power dissipation	65	90	mW
Reverse voltage	Not recommended for reverse bias		V
Maximum junction temperature T_j max	110		$^\circ\text{C}$
Operating temperature range	-40 to +100		$^\circ\text{C}$
Storage temperature range	-40 to +100		$^\circ\text{C}$

Notes:

1. Derate linearly as shown in Figure 4a and Figure 4b
2. Duty Factor = 10% Frequency = 1 kHz

Table 3. Optical Characteristics ($T_A = 25\text{ }^\circ\text{C}$)

Color	Luminous Intensity, I_v , mcd [1]			Dominant Wavelength, λ_d (nm) [2]			Peak Wavelength, λ_p (nm)	Viewing Angle $2\theta_{1/2}$ ($^\circ$) [3]
	Min.	Typ.	Max.	Min.	Typ.	Max.	Typ.	Typ.
Red	450	540	900	619.0	625.0	629.0	634	115
Green	1125	1600	2240	525.0	530.0	535.0	522	115
Blue	285	350	560	465.0	470.0	473.0	465	115

Notes:

1. The luminous intensity I_v is measured at the mechanical axis of LED package and it is tested in pulsing condition. The actual peak of the spatial radiation pattern may not be aligned with the axis.
2. The dominant wavelength is derived from the CIE Chromaticity Diagram and represents the perceived color of the device.
3. $\theta_{1/2}$ is the off-axis angle where the luminous intensity is $1/2$ the peak intensity

Table 4. Electrical Characteristics ($T_A = 25\text{ }^\circ\text{C}$)

Color	Forward Voltage, V_F (V) [1]			Reverse Voltage V_R @ 100 μA [2]	Reverse Voltage V_R @ 10 μA [2]	Thermal Resistance $R\theta_{J-P}$ ($^\circ\text{C}/\text{W}$)	
	Min.	Typ.	Max.	Min.	Min.	Single chip on	3 chips on
Red	1.8	2.1	2.6	4	-	609	653
Green	2.8	3.1	3.6	-	4	320	430
Blue	2.8	3.1	3.6	-	4	320	430

Notes:

1. Tolerance ± 0.1 V.
2. Indicates product final testing condition. Reverse bias is not recommended.

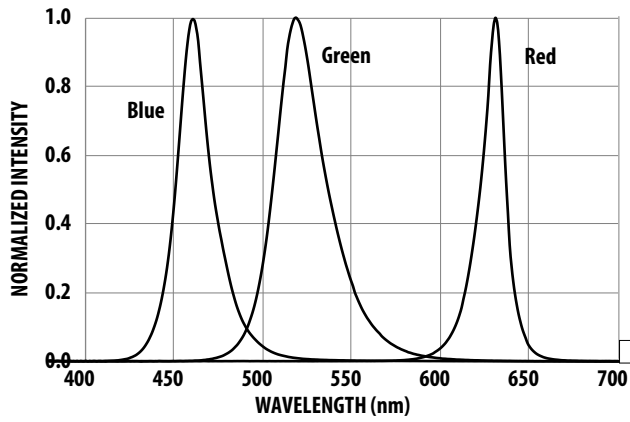

Figure 1. Relative Intensity vs. Wavelength

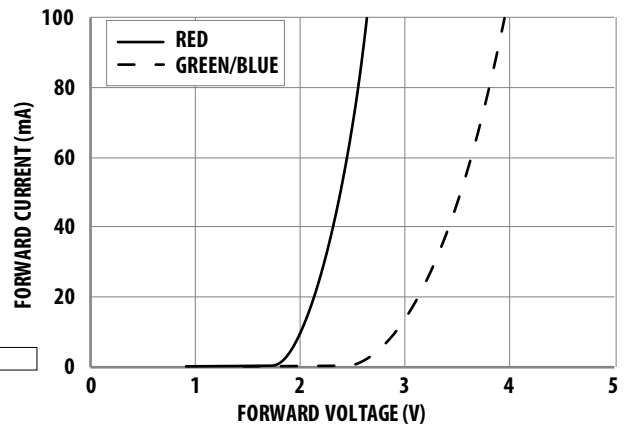

Figure 2. Forward Current vs. Forward Voltage

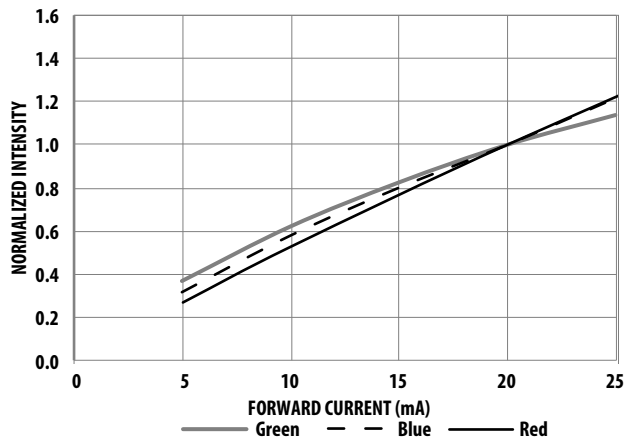

Figure 3. Relative Intensity vs. Forward Current

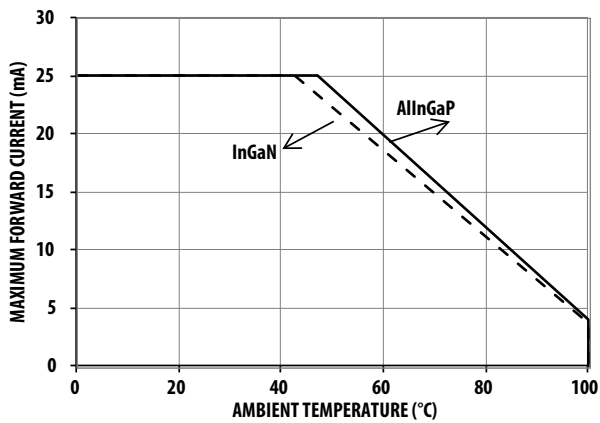

Figure 4a. Maximum forward current vs. ambient temperature. (3 chips)

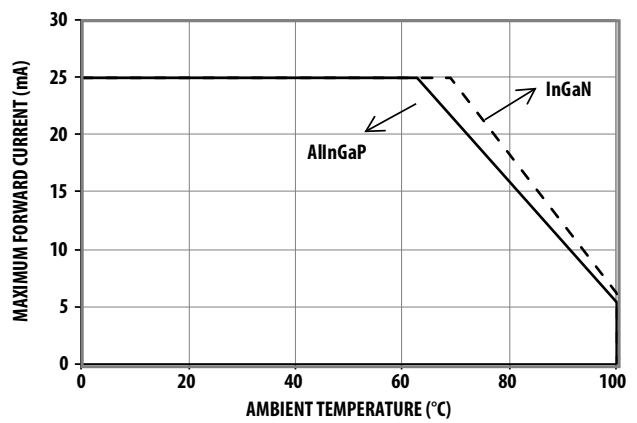

Figure 4b. Maximum forward current vs. ambient temperature. (single chip)

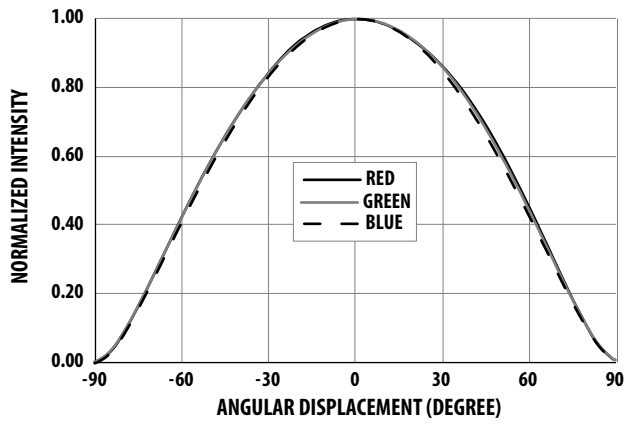

Figure 5a. Radiation Pattern for X axis

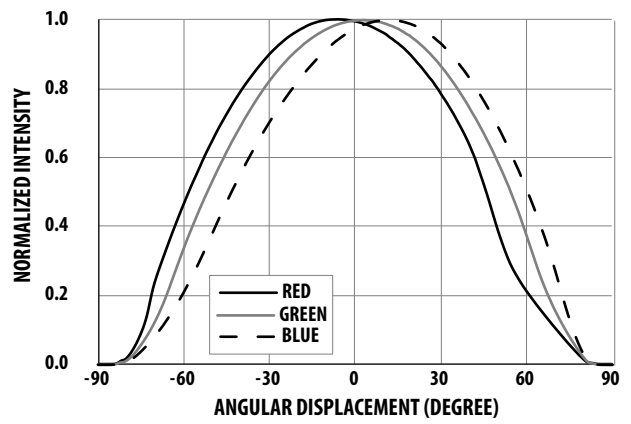

Figure 5a. Radiation Pattern for Y axis

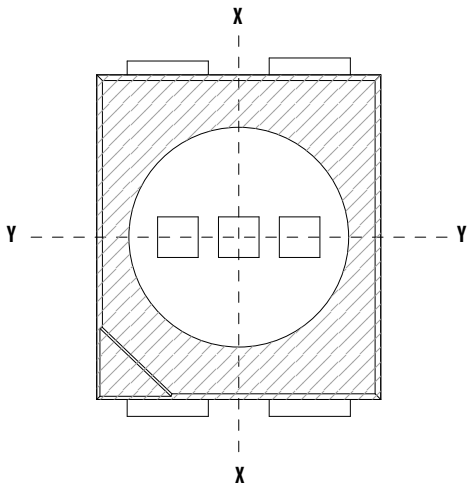

Figure 5c. Component Axis for Radiation Patterns

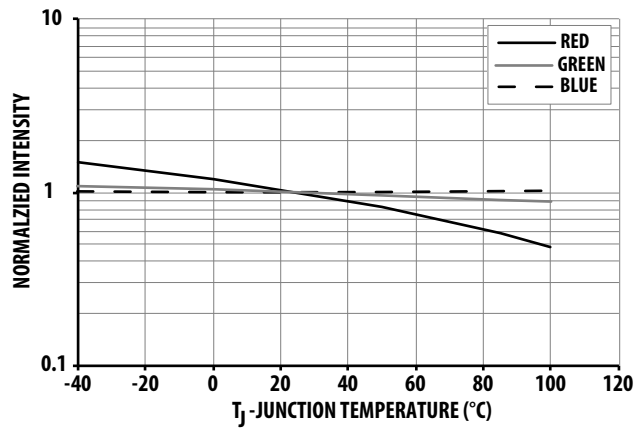

Figure 6. Relative Intensity vs. Junction Temperature

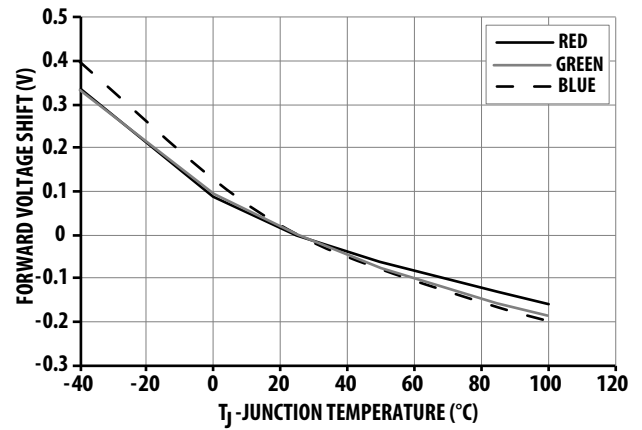

Figure 7. Forward Voltage vs. Junction Temperature

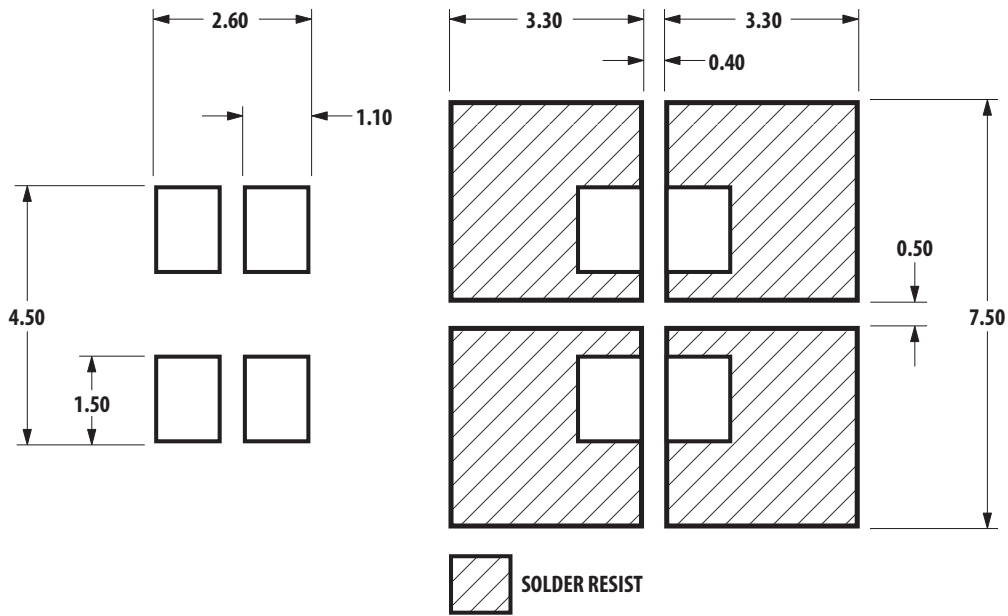

Figure 8a. Recommended soldering land pattern

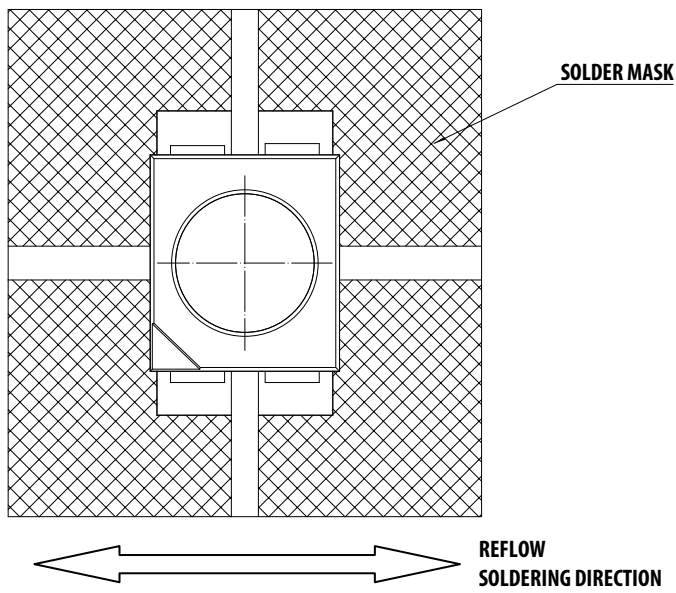

Figure 8b. LED configuration on land pattern

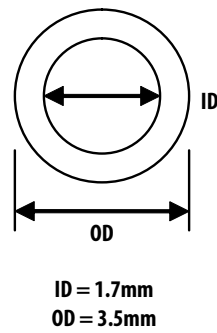

Figure 9. Recommended Pick and Place Nozzle Tip

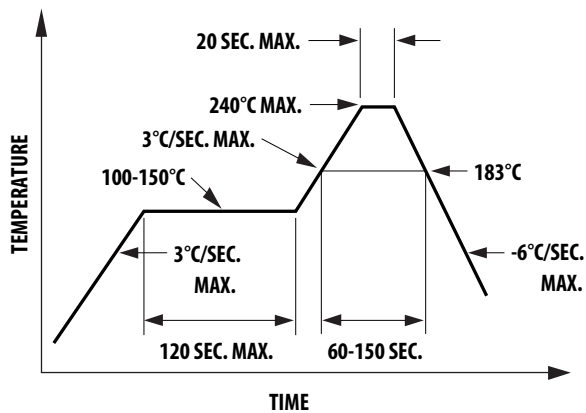

Figure 10. Recommended leaded reflow soldering profile

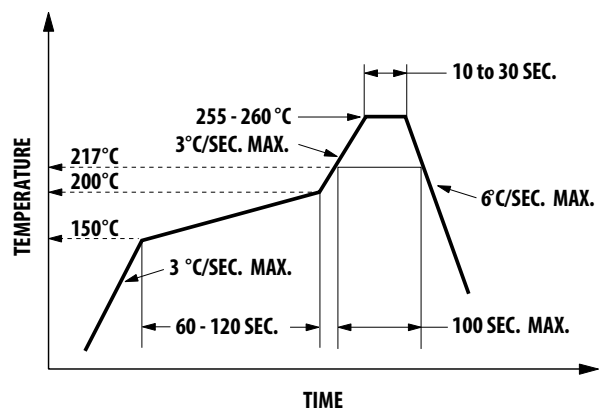

Figure 11. Recommended Pb-free reflow soldering profile

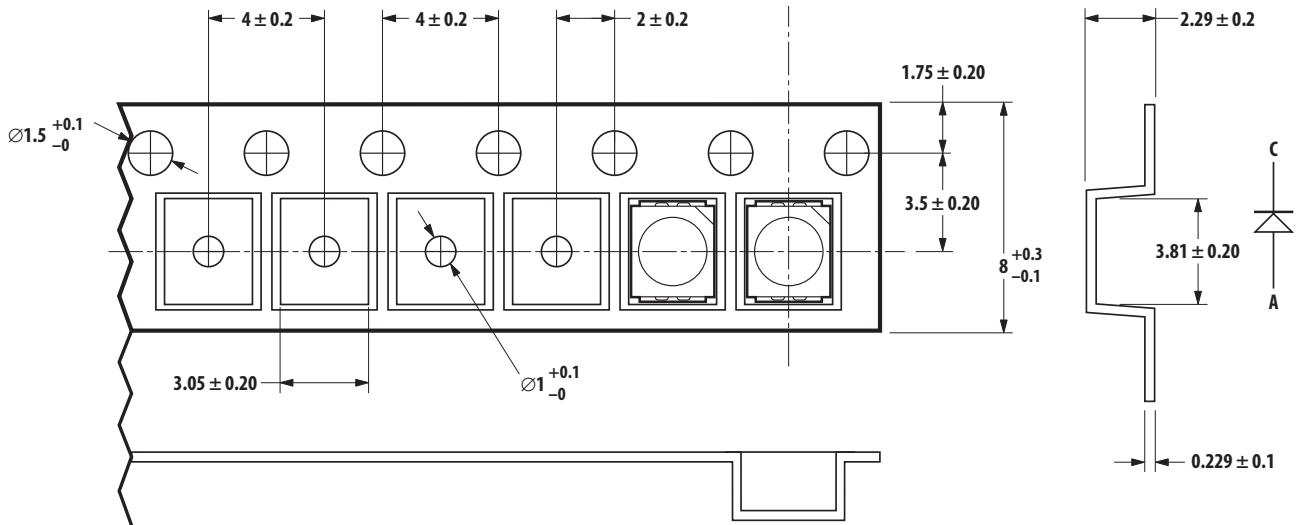

Figure 12. Carrier Tape Dimension

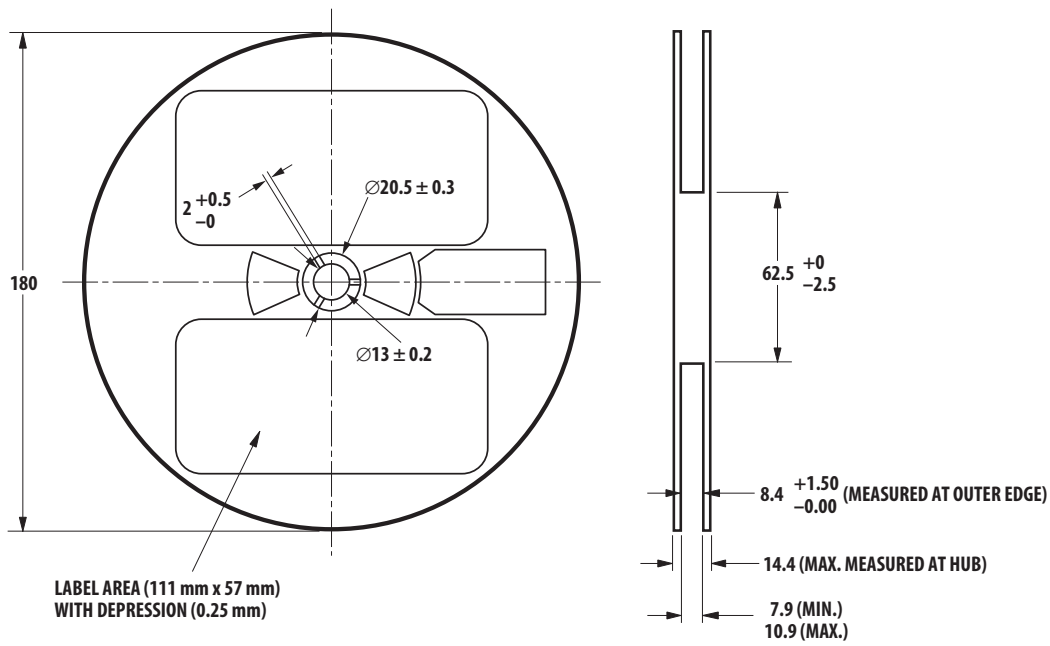

Figure 13. Reel Dimension

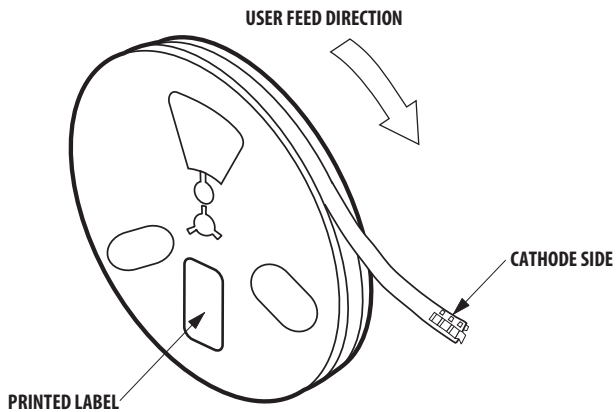















Figure 14. Reel Orientation

Packaging Label

(i) Avago Mother Label (Available on MBB bags)

<p>(1P) Item: Part Number </p>		<p>Avago TECHNOLOGIES STANDARD LABEL LS0002 RoHS Compliant Halogen Free e4 Max Temp 260C MSL3 (Q) QTY: Quantity</p>	
<p>(1T) Lot: Lot Number </p>		<p>CAT: Intensity Bin </p>	
<p>LPN: </p>		<p>BIN: Color Bin </p>	
<p>(9D)MFG Date: Manufacturing Date </p>			
<hr/>			
<p>(P) Customer Item: </p>			
<p>(V) Vendor ID: </p>		<p>(9D) Date Code: Date Code </p>	
<p>DeptID: </p>		<p>Made In: Country of Origin </p>	

(ii) Avago Baby Label (Available on reel)

<p>(1P) PART #: Part Number </p>		<p>Avago TECHNOLOGIES BABY LABEL COSB001B</p>	
<p>(1T) LOT #: Lot Number </p>			
<p>(9D)MFG DATE: Manufacturing Date </p>		<p>QUANTITY: Packing Quantity </p>	
<p>C/O: Country of Origin</p>		<p>(9D): DATE CODE:</p>	
<hr/>			
<p>(1T) TAPE DATE: </p>		<p>D/C: Date Code VF:</p>	
		<p>CAT: INTENSITY BIN</p>	
		<p>BIN: COLOR BIN</p>	

Example indicates luminous Intensity information for Red, Green and Blue, respectively, from label:

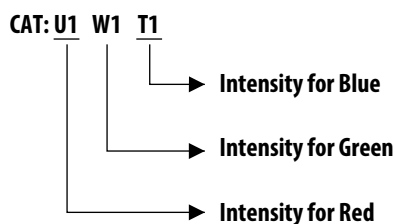

Example indicates color bin information for Green and Blue from label:

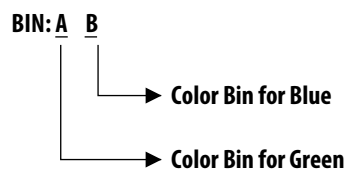

Note:

There will be no red color bin information appear on label as it is not binned and support with full distribution range.

Handling Precaution

The encapsulation material of the LED is made of silicone for better product reliability. Because silicone is a soft material, please avoid pressing on the silicone or poking it with a sharp object; this can damage the product and cause premature failure. When handling during assembly, hold the unit only by its body. For additional handling information and proper procedures, refer to Avago Application Note AN 5288.

Moisture Sensitivity

This product has a Moisture Sensitive Level 3 rating per JEDEC J-STD-020. For additional details and a review of proper handling procedures, refer to Avago Application Note AN5305, *Handling of Moisture Sensitive Surface Mount Devices*.

A. Storage before use

- An unopened moisture barrier bag (MBB) can be stored at <40 °C/90% RH for 12 months. If the actual shelf life has exceeded 12 months and the Humidity Indicator Card (HIC) indicates that baking is not required, then it is safe to reflow the LEDs per the original MSL rating.
- It is recommended that you do not open the MBB before assembly (e.g., for IQC).

B. Control after opening the MBB

- The Humidity Indicator Card (HIC) shall be read immediately upon opening of MBB.
- The LEDs must be kept at < 30 °C / 60% RH at all times and all high temperature related processes including soldering, curing or rework need to be completed within 168 hours.

C. Control for unfinished reel

- Unused LEDs must be stored in a sealed MBB with a desiccant or desiccator at < 5% RH.

D. Control of assembled boards

- If the PCB soldered with the LEDs is to be subjected to other high temperature processes, the PCB needs to be stored in a sealed MBB with a desiccant or desiccator at < 5% RH to ensure that all LEDs have not exceeded their floor life of 168 hours.

E. Baking is required if:

- The HIC indicator is not BROWN at 10% and is AZURE at 5%.
- The LEDs are exposed to condition of > 30 °C / 60% RH at any time.
- The LED floor life exceeded 168 hours.

The recommended baking condition is: 60 ± 5 °C for 20 hours.

Note:

All bin categories are established for classification of products. Products may not be available in all bin categories. Please contact your Avago representative for further information

DISCLAIMER: Avago's products and software are not specifically designed, manufactured or authorized for sale as parts, components or assemblies for the planning, construction, maintenance or direct operation of a nuclear facility or for use in medical devices or applications. Customer is solely responsible, and waives all rights to make claims against Avago or its suppliers, for all loss, damage, expense or liability in connection with such use.

For product information and a complete list of distributors, please go to our web site: www.avagotech.com

Avago, Avago Technologies, and the A logo are trademarks of Avago Technologies in the United States and other countries. Data subject to change. Copyright © 2005-2013 Avago Technologies. All rights reserved. AV02-4186EN - June 19, 2013

AVAGO
TECHNOLOGIES

Компания «Океан Электроники» предлагает заключение долгосрочных отношений при поставках импортных электронных компонентов на взаимовыгодных условиях!

Наши преимущества:

- Поставка оригинальных импортных электронных компонентов напрямую с производств Америки, Европы и Азии, а так же с крупнейших складов мира;
- Широкая линейка поставок активных и пассивных импортных электронных компонентов (более 30 млн. наименований);
- Поставка сложных, дефицитных, либо снятых с производства позиций;
- Оперативные сроки поставки под заказ (от 5 рабочих дней);
- Экспресс доставка в любую точку России;
- Помощь Конструкторского Отдела и консультации квалифицированных инженеров;
- Техническая поддержка проекта, помощь в подборе аналогов, поставка прототипов;
- Поставка электронных компонентов под контролем ВП;
- Система менеджмента качества сертифицирована по Международному стандарту ISO 9001;
- При необходимости вся продукция военного и аэрокосмического назначения проходит испытания и сертификацию в лаборатории (по согласованию с заказчиком);
- Поставка специализированных компонентов военного и аэрокосмического уровня качества (Xilinx, Altera, Analog Devices, Intersil, Interpoint, Microsemi, Actel, Aeroflex, Peregrine, VPT, Syfer, Eurofarad, Texas Instruments, MS Kennedy, Miteq, Cobham, E2V, MA-COM, Hittite, Mini-Circuits, General Dynamics и др.);

Компания «Океан Электроники» является официальным дистрибьютором и эксклюзивным представителем в России одного из крупнейших производителей разъемов военного и аэрокосмического назначения «JONHON», а так же официальным дистрибьютором и эксклюзивным представителем в России производителя высокотехнологичных и надежных решений для передачи СВЧ сигналов «FORSTAR».



JONHON

«JONHON» (основан в 1970 г.)

Разъемы специального, военного и аэрокосмического назначения:

(Применяются в военной, авиационной, аэрокосмической, морской, железнодорожной, горно- и нефтедобывающей отраслях промышленности)

«FORSTAR» (основан в 1998 г.)

ВЧ соединители, коаксиальные кабели,
кабельные сборки и микроволновые компоненты:

(Применяются в телекоммуникациях гражданского и специального назначения, в средствах связи, РЛС, а так же военной, авиационной и аэрокосмической отраслях промышленности).



Телефон: 8 (812) 309-75-97 (многоканальный)

Факс: 8 (812) 320-03-32

Электронная почта: ocean@oceanchips.ru

Web: <http://oceanchips.ru/>

Адрес: 198099, г. Санкт-Петербург, ул. Калинина, д. 2, корп. 4, лит. А