

# Moseni Antenna for LTE applications

Part No. SRFL029

flexiiANT<sup>®</sup>

Product Specification

## 1. Features

- Antenna for 4G LTE applications including MIMO systems.
- LTE 700, GSM850, GSM900, DCS1800, PCS1900, WCDMA2100, LTE B7 (2500-2690 MHz), LTE B40 (2300 – 2400 MHz)
- 1.13mm diameter RF cable with IPEX MHF connector
- Self-adhesive mounted
- Quick and simple integration minimizes design cycle
- Available in 3 standard cable lengths

## 2. Description

Moseni is intended for use with 4G LTE applications. This product specification shows the performance of this antenna in all workable bands. Simplified integration with plug and play simplicity.

## 3. Applications

- Smart meters
- Network devices
- Femto / Pico base stations
- Telematics
- Remote monitoring
- Machine to Machine
- POS (Point of Sale) terminals



## 4. Part Number

**Moseni: SRFL029**



## 5. General Data

Product name	Moseni
Part Number	SRFL029
Frequency	698-798MHz 824-960MHz 1710-2170MHz 2300-2400MHz 2500-2690MHz
Polarization	Linear
Operating temperature	-40°C to +85°C
Impedance with matching	50 $\Omega$
Weight	< 0.5 g
Antenna type	FPC Self-adhesive 3M 468P
Dimensions (Antenna)	110.0 x 20.0 x 0.15 (mm)
Connection	IPEX

## 6. RF Characteristics

	698 – 798 MHz	824 – 960 MHz	1710 - 2170 MHz
Peak gain	3.50dBi	3.50dBi	3.80dBi
Average gain	-1.60dBi	-1.70dBi	-1.40dBi
Average efficiency	>60%	>60%	>65%
Maximum return loss	-5.0dB	-8.0dB	-5.5dB
Maximum VSWR	3.50:1	2.40:1	3.30:1

	2300 – 2400 MHz	2500 – 2690 MHz
Peak gain	4.50dBi	4.60dBi
Average gain	-0.70dBi	-0.50dBi
Average efficiency	>80%	>80%
Maximum return loss	-12dB	-16dB
Maximum VSWR	1.40:1	1.70:1

*All data measured in a loaded condition adhered to a 1.6mm thick plastic carrier free space.*

*An RF choke was used to prevent cable radiation.*

## 7. RF Performance

### 7.1 Return Loss

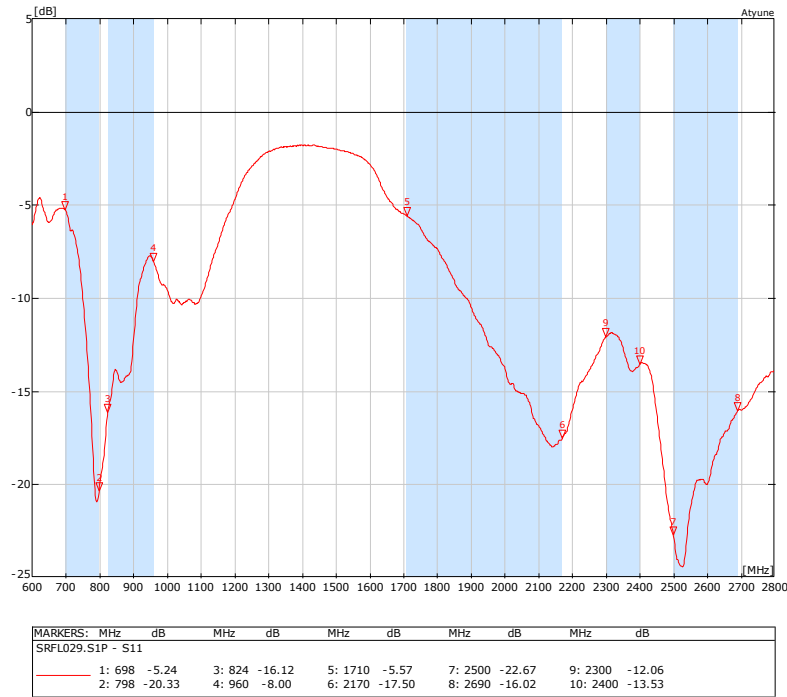

### 7.2 VSWR

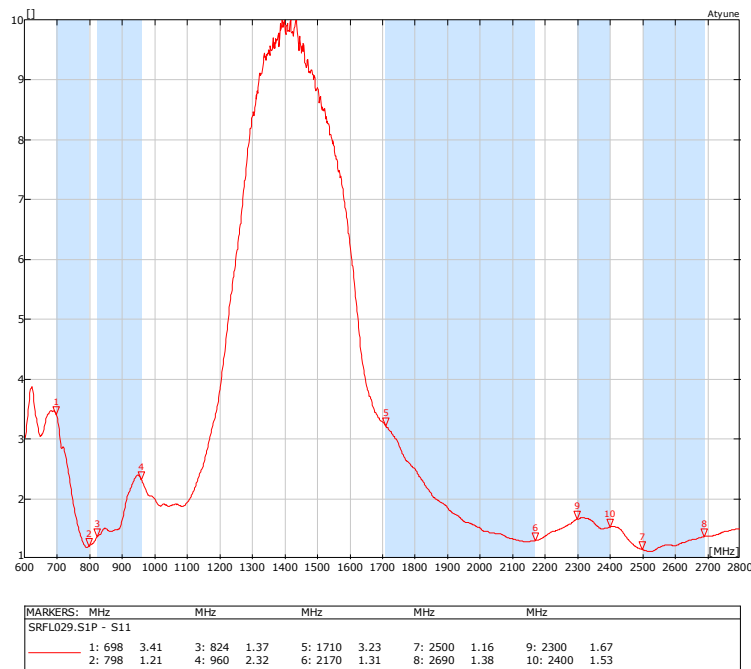

## 7.3 Antenna patterns

### 7.3.1 698 MHz – 798 MHz

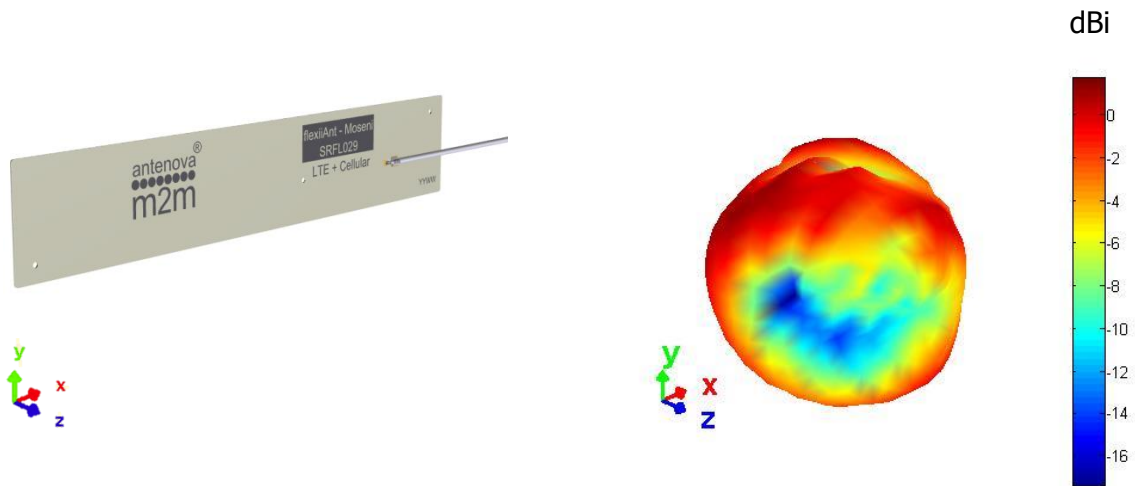

**3D pattern at 745 MHz**  
*Drag to rotate pattern and PCB by using Adobe Reader  
(Click to Activate)*

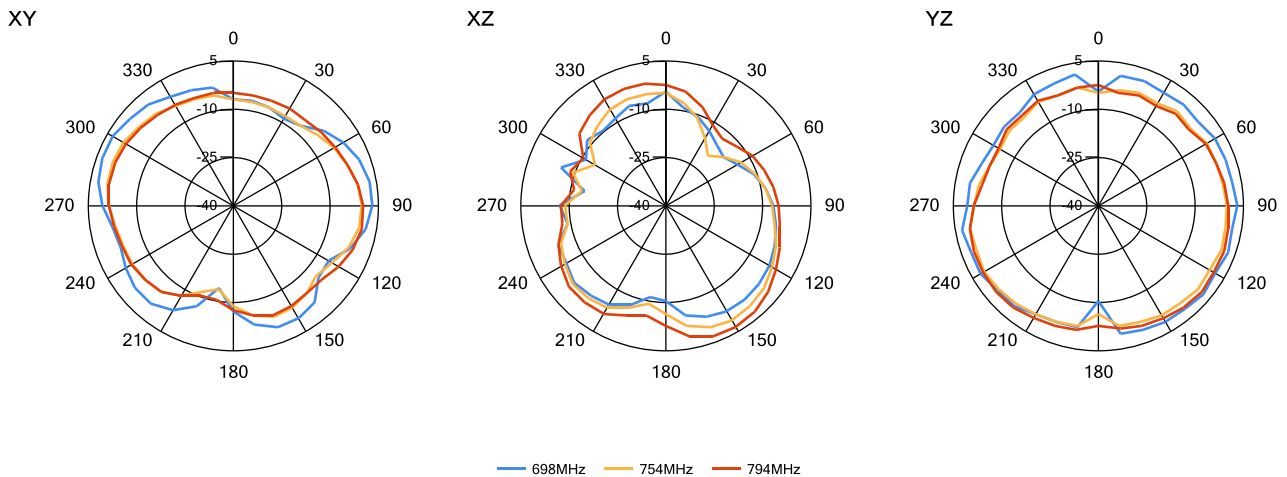

### 7.3.2 824 MHz – 960 MHz

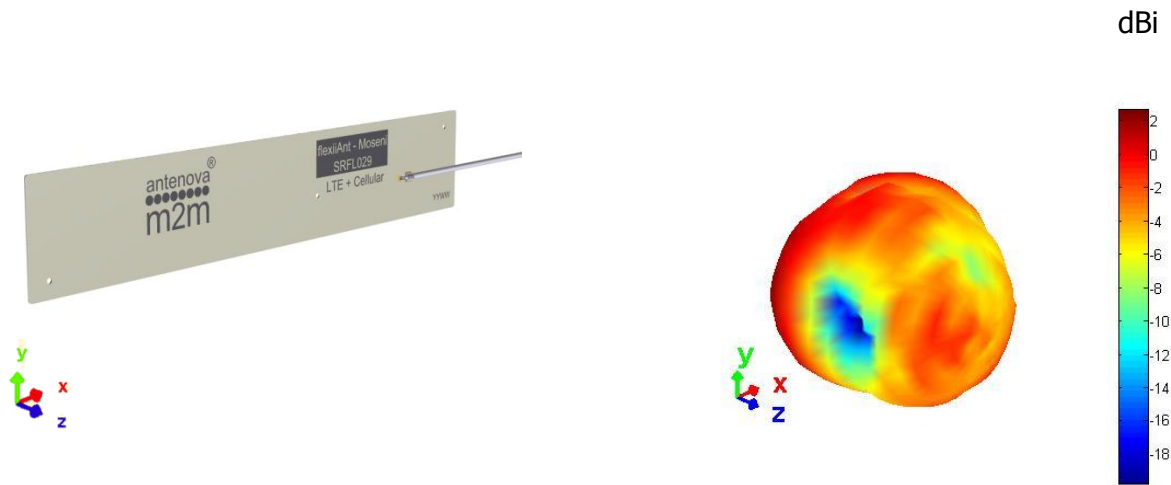

**3D pattern at 890 MHz**  
*Drag to rotate pattern and PCB by using Adobe Reader  
(Click to Activate)*

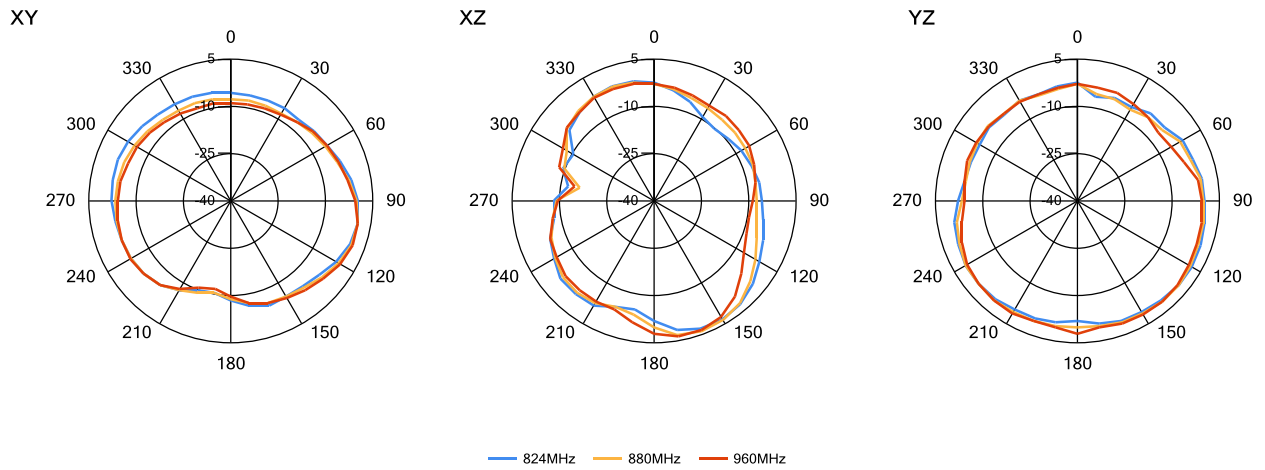

### 7.3.3 1710 MHz – 2170 MHz

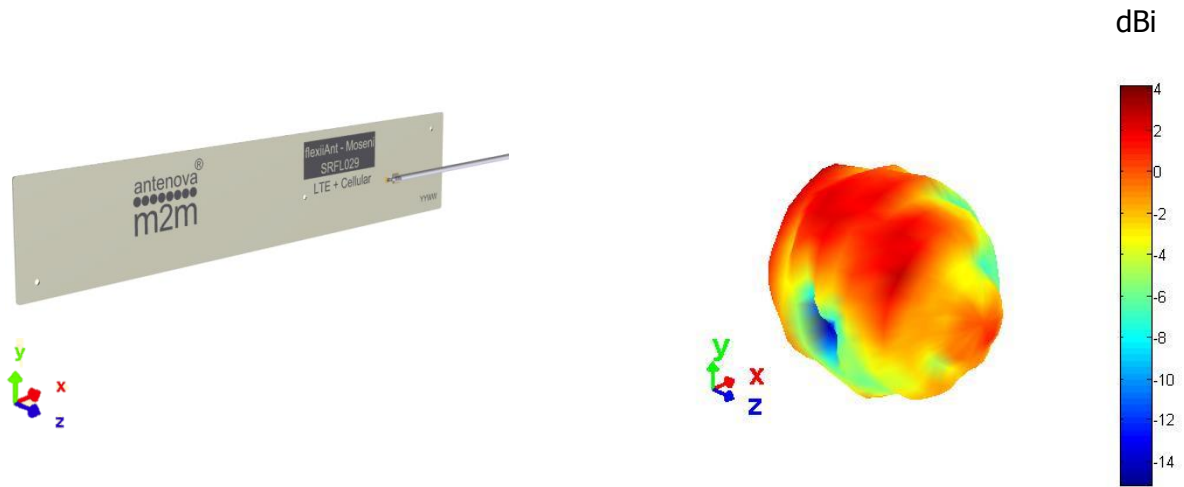

**3D pattern at 1990 MHz**  
*Drag to rotate pattern and PCB by using Adobe Reader  
(Click to Activate)*

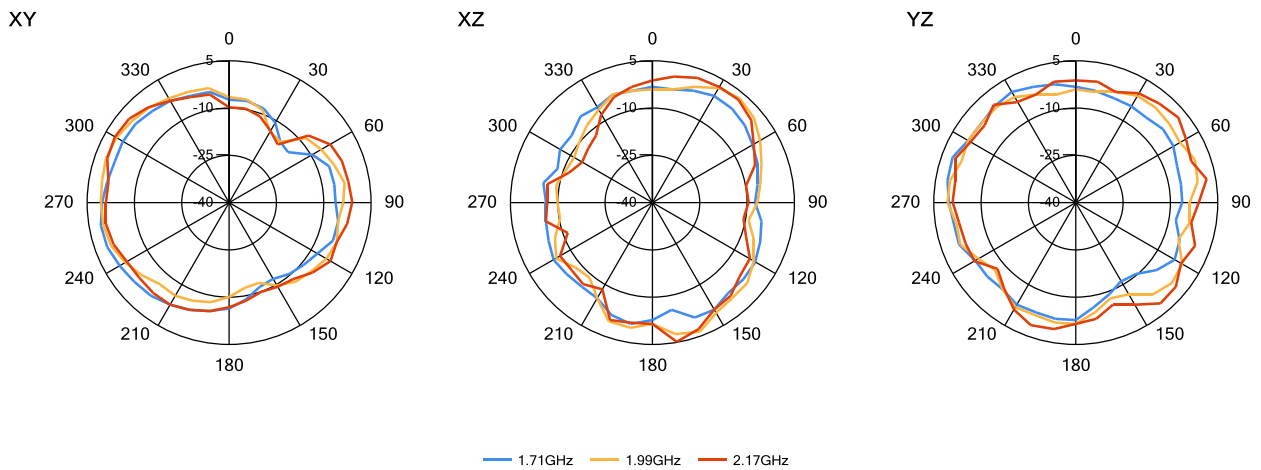

### 7.3.4 2300 MHz – 2400 MHz

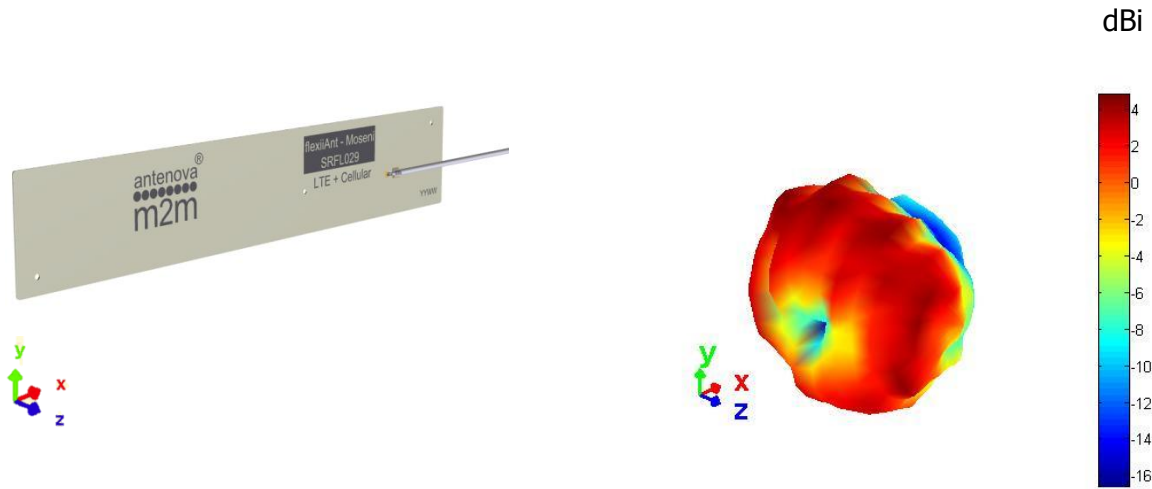

**3D pattern at 2350 MHz**  
*Drag to rotate pattern and PCB by using Adobe Reader  
(Click to Activate)*

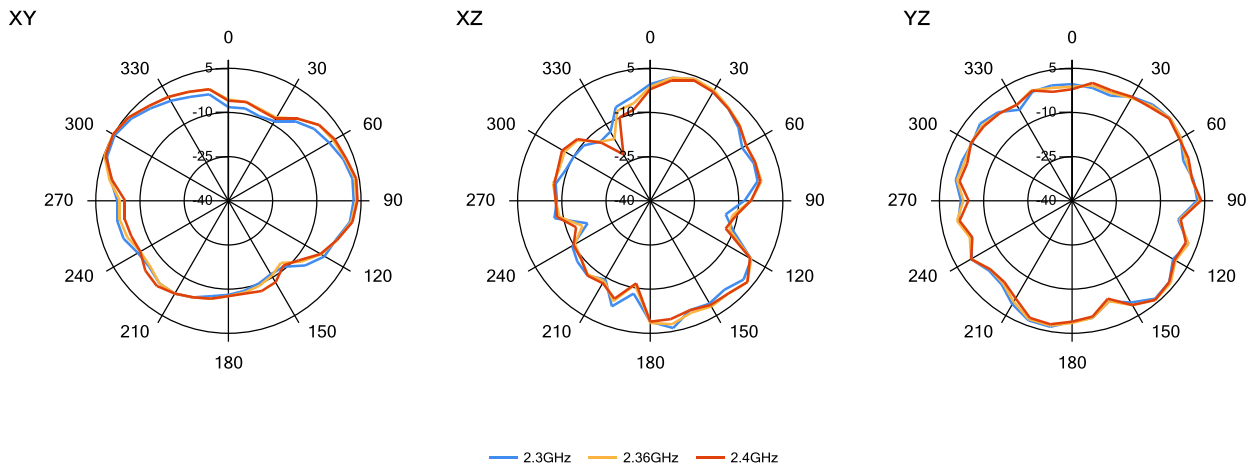



### 7.3.5 2500 MHz – 2690 MHz

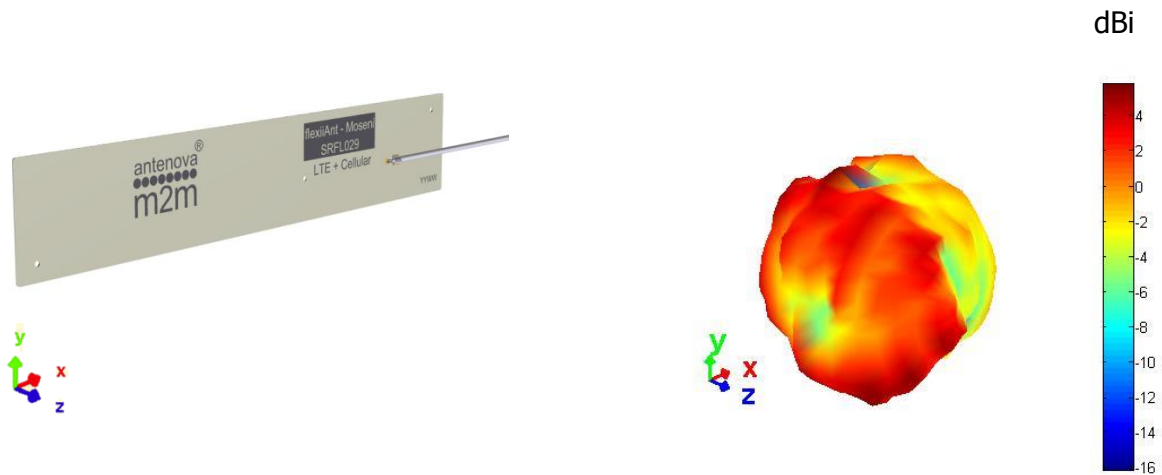

**3D pattern at 2600 MHz**  
*Drag to rotate pattern and PCB by using Adobe Reader  
(Click to Activate)*

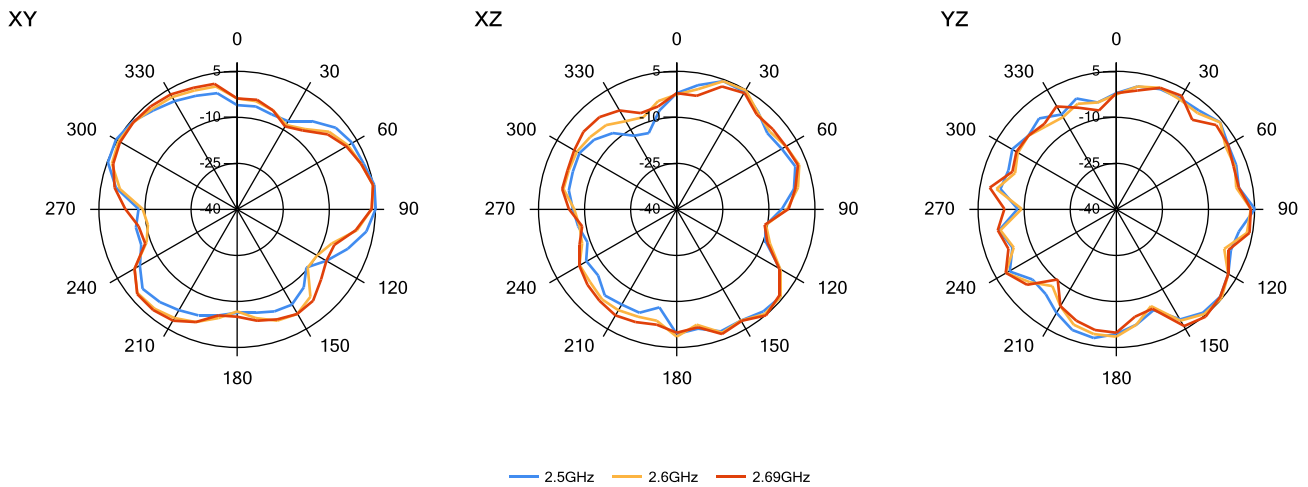

## 8. Antenna Dimensions

### 8.1 Dimensions FPC section

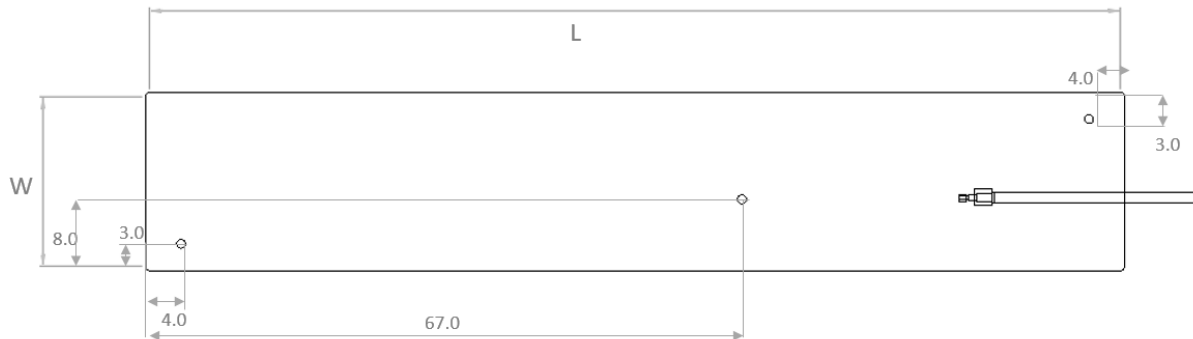

L	W	T
Length	Width	Thickness
110.0 ±0.2 (mm)	20.0 ±0.2 (mm)	0.15 (mm) nominal

All dimensions in mm

### 8.2 Dimensions assembled

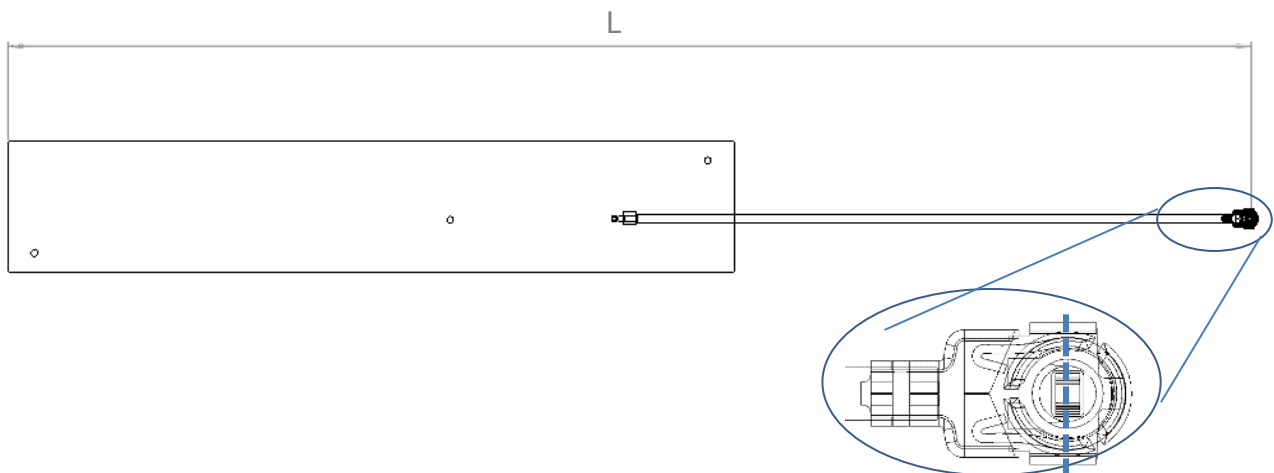

SRFL029-100	SRFL029-150	SRFL029-200
L	L	L
189 ±2.0 (mm)	239 ±2.0 (mm)	289 ±2.0 (mm)

Antennas for Wireless M2M Applications

### 8.3 IPEX Connector

I-PEX	
Material	Copper Alloy
Plating	Ag

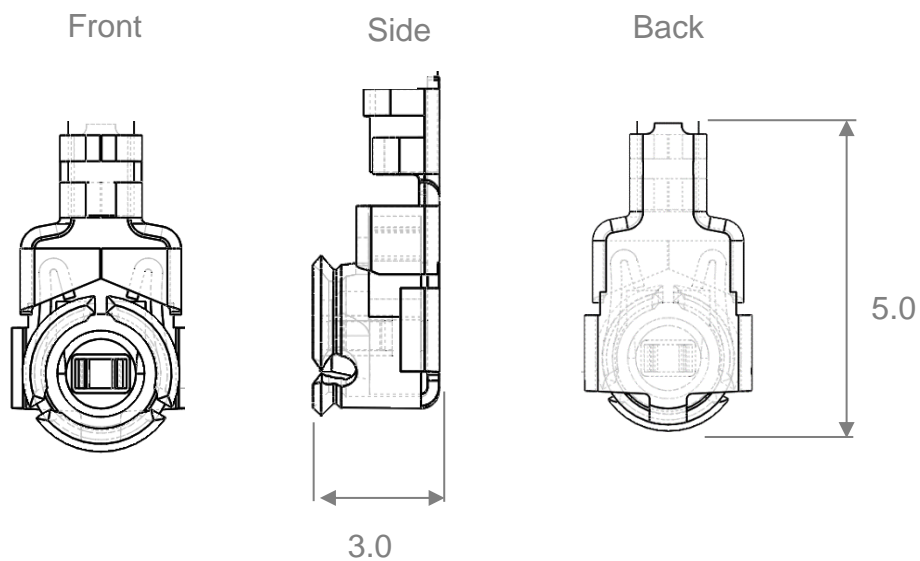
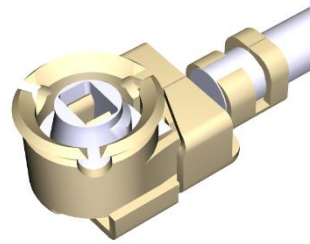

All dimensions in mm

### 8.4 Assembly

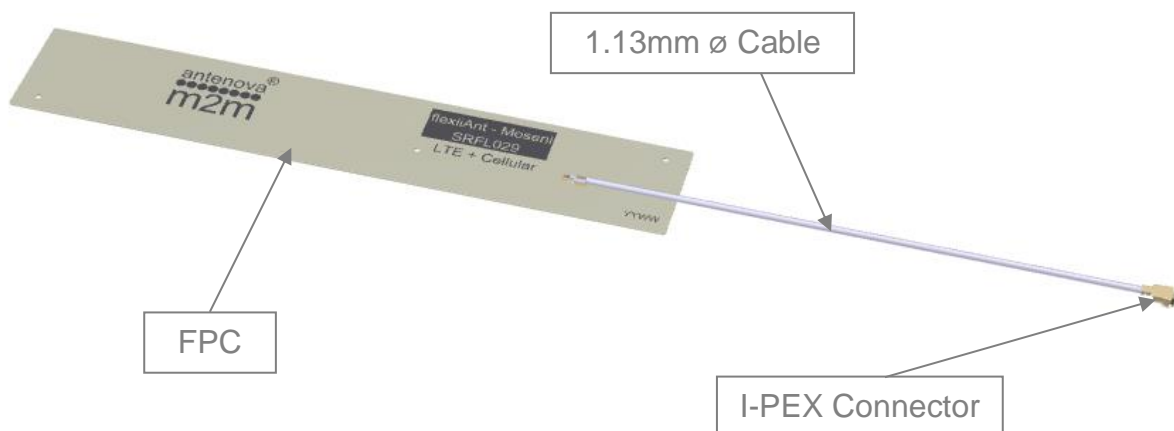

Antennas for Wireless M2M Applications

## 9. Electrical Interface

### 9.1 Host Interface

The host PCB requires the mating connector which is IPEX MHF (UFL) receptacle. The location should be close to the chip/modules pin for the RF. Any feed from this receptacle should be maintained at 50Ω impedance.

### 9.2 Transmission Line

All transmission lines should be designed to have a characteristic impedance of 50Ω.

- The length of the transmission lines should be kept to a minimum
- Any other parts of the RF system like transceivers, power amplifiers, etc, should also be designed to have an impedance of 50 Ω

Once the material for the PCB has been chosen (PCB thickness and dielectric constant), a coplanar transmission line can easily be designed using any of the commercial software packages for transmission line design. For the chosen PCB thickness, copper thickness and substrate dielectric constant, the program will calculate the appropriate transmission line width and gaps on either side of the feed.

A DC blocking capacitor should be placed in line to protect the RF front end.

## 10. Mechanical Fixing

The antenna uses 3M 468MP adhesive on the reverse side of the FPC. The antenna has an easy access split line to peel off to reveal the adhesive side. It is designed for a one time fix to a clean smooth surface.

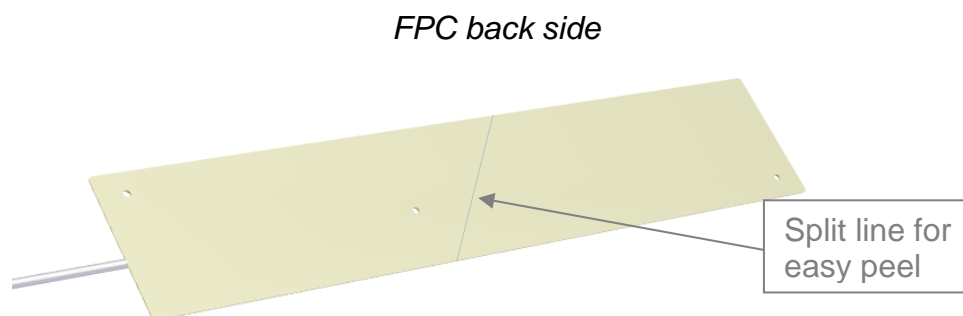

## 10.0 Antenna Integration Guide

### 10.1 Placement

For placing the FPC antenna within a device, the host PCB size is not a factor like with PCB mounted antennas. However the placement still needs to follow some basic rules, as any antenna is sensitive to its environment.

Using six spatial directions shown below as a guide. The antenna FPC section should try to maintain a minimum of three directions free from obstructions to be able to operate effectively. The other directions will have obstacles in their paths, these directions still require a minimum clearance. These minimum clearances are further defined in this section. The plastic case is not included in this, only metal objects/components that will obstruct or come in close proximity to the antenna.

*Six spatial directions relative to FPC*

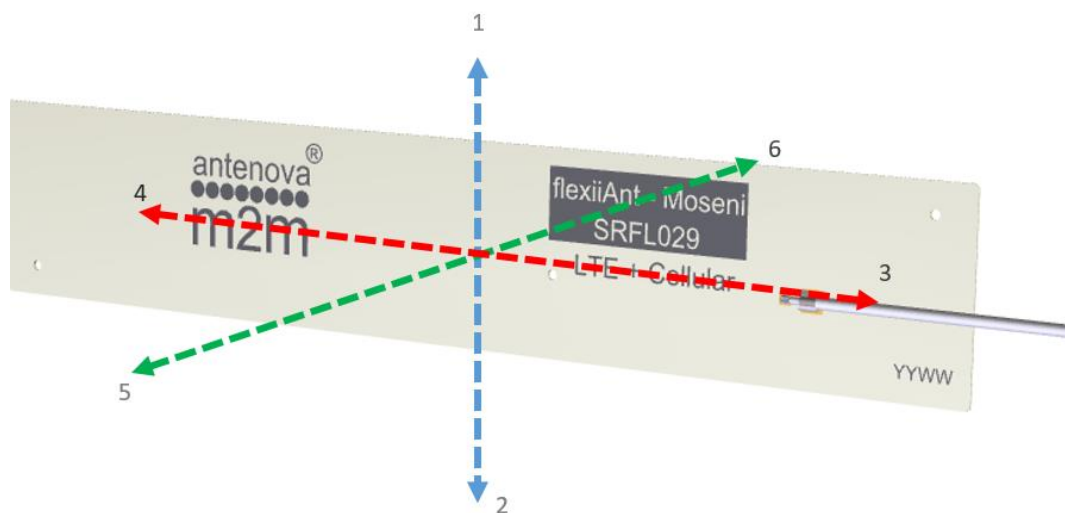

## 10.2 Orientation of FPC

The orientation of the FPC with respect to the host PCB should be defined depending on the unit. The proximity of the GND will have an influence on the antenna so the PCB location relative to the antenna should be considered.

The FPC will normally be placed in one of the three following options for orientation. In each option a distance (d) is the critical dimension to consider. Below shows the minimum value of (d) for each. Other obstructions may increase this dimension.

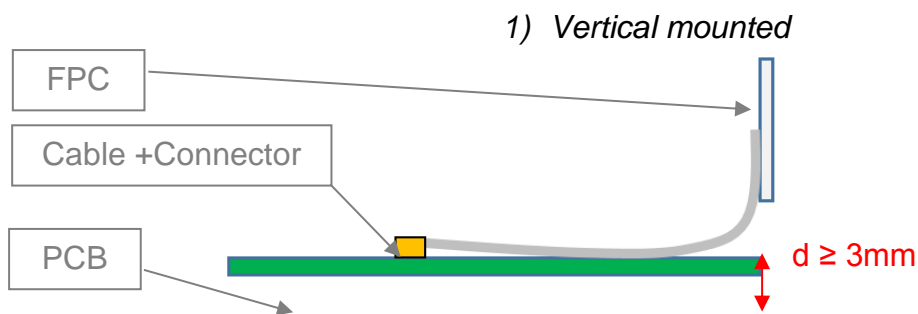

1) *Co-planar to PCB*



2) *Planar to PCB (Same plane)*



## 11. Hazardous Material Regulation Conformance

The antenna has been tested to conform to RoHS requirements. A certificate of conformance is available from Antenova M2M's website.

## 12. Packaging

The antennas are stored in individual plastic (PE) bags. Then stored within a second bag of 10pcs.

*Single antenna per bag*



*10 units per second bag (Labelled)*



### 12.1 Optimal Storage Conditions

Temperature	-10°C to 40°C
Humidity	Less than 75% RH
Shelf life	18 Months provided the bag of 10 pieces remains factory sealed
Storage place	Away from corrosive gas and direct sunlight
Packaging	Antennas should be stored in unopened sealed manufacturer's plastic packaging.

## 12.2 Label Information

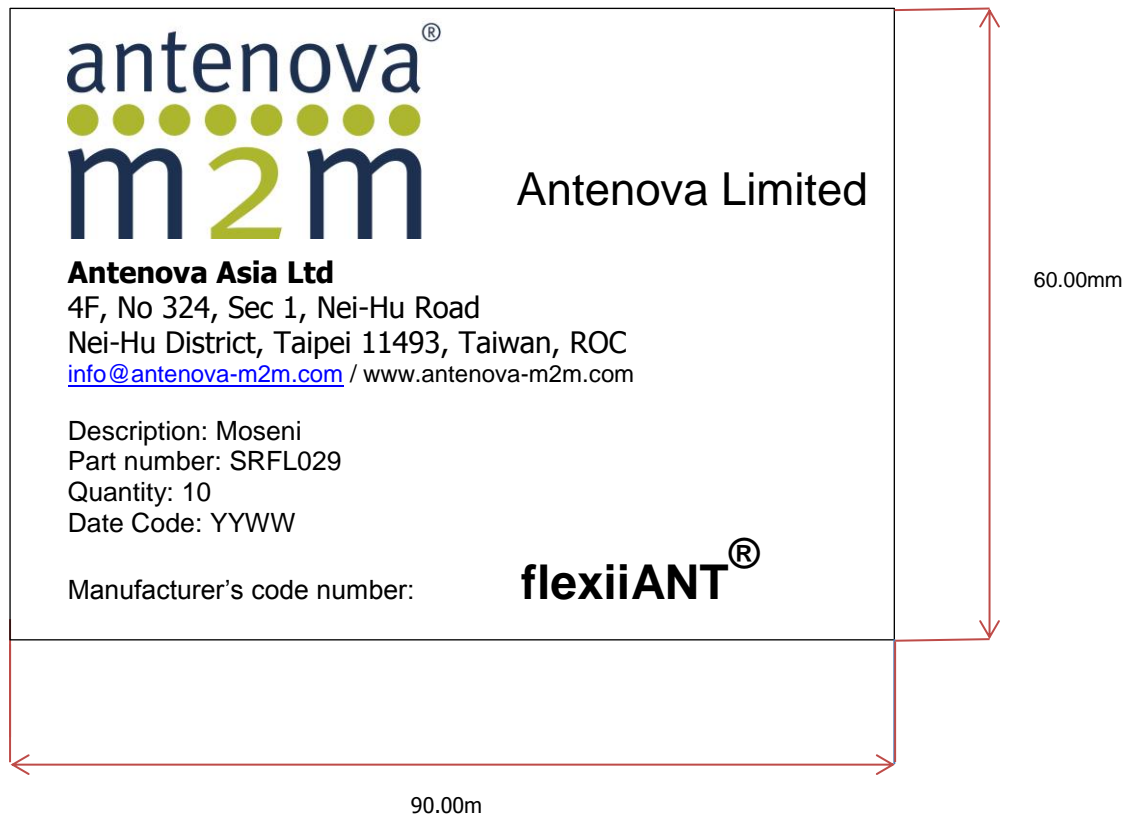





[www.antenova-m2m.com](http://www.antenova-m2m.com)

#### Corporate Headquarters

Antenova Limited  
2<sup>nd</sup> Floor Titan Court  
3 Bishop Square  
Hatfield  
AL10 9NA  
UK

**Tel:** +44 1223 810600

**Email:** [sales@antenova-m2m.com](mailto:sales@antenova-m2m.com)

#### North America Headquarters

Antenova Limited  
100 Brush Creek Road, Suite 103,  
Santa Rosa  
California 95404  
USA

**Tel:** +1 707 890 5202

**Email:** [sales@antenova-m2m.com](mailto:sales@antenova-m2m.com)

#### Asia Headquarters

Antenova Asia Limited  
4F, No. 324, Sec. 1, Nei-Hu Road  
Nei-Hu District  
Taipei 11493  
Taiwan, ROC

**Tel:** +886 (0) 2 8797 8630

**Fax:** +886 (0) 2 8797 6890

**Email:** [sales@antenova-m2m.com](mailto:sales@antenova-m2m.com)

**Copyright© Antenova Ltd.** All Rights Reserved. Antenova®, Antenova M2M®, gigaNOVA® the Antenova product family names, and the Antenova and Antenova M2M logos are trademarks and/or registered trademarks of Antenova Ltd. Any other names and/or trademarks belong to their respective companies.

The materials provided herein are believed to be reliable and correct at the time of printing. Antenova does not warrant the accuracy or completeness of the information, text, graphics or other items contained within this information. Antenova further assumes no responsibility for the use of this information, and all such information shall be entirely at the user's risk.



Certificate No: 4598

Antennas for Wireless M2M Applications

Компания «Океан Электроники» предлагает заключение долгосрочных отношений при поставках импортных электронных компонентов на взаимовыгодных условиях!

Наши преимущества:

- Поставка оригинальных импортных электронных компонентов напрямую с производств Америки, Европы и Азии, а так же с крупнейших складов мира;
- Широкая линейка поставок активных и пассивных импортных электронных компонентов (более 30 млн. наименований);
- Поставка сложных, дефицитных, либо снятых с производства позиций;
- Оперативные сроки поставки под заказ (от 5 рабочих дней);
- Экспресс доставка в любую точку России;
- Помощь Конструкторского Отдела и консультации квалифицированных инженеров;
- Техническая поддержка проекта, помощь в подборе аналогов, поставка прототипов;
- Поставка электронных компонентов под контролем ВП;
- Система менеджмента качества сертифицирована по Международному стандарту ISO 9001;
- При необходимости вся продукция военного и аэрокосмического назначения проходит испытания и сертификацию в лаборатории (по согласованию с заказчиком);
- Поставка специализированных компонентов военного и аэрокосмического уровня качества (Xilinx, Altera, Analog Devices, Intersil, Interpoint, Microsemi, Actel, Aeroflex, Peregrine, VPT, Syfer, Eurofarad, Texas Instruments, MS Kennedy, Miteq, Cobham, E2V, MA-COM, Hittite, Mini-Circuits, General Dynamics и др.);

Компания «Океан Электроники» является официальным дистрибьютором и эксклюзивным представителем в России одного из крупнейших производителей разъемов военного и аэрокосмического назначения «JONHON», а так же официальным дистрибьютором и эксклюзивным представителем в России производителя высокотехнологичных и надежных решений для передачи СВЧ сигналов «FORSTAR».



## JONHON

«JONHON» (основан в 1970 г.)

Разъемы специального, военного и аэрокосмического назначения:

(Применяются в военной, авиационной, аэрокосмической, морской, железнодорожной, горно- и нефтедобывающей отраслях промышленности)

«FORSTAR» (основан в 1998 г.)

ВЧ соединители, коаксиальные кабели,  
кабельные сборки и микроволновые компоненты:

(Применяются в телекоммуникациях гражданского и специального назначения, в средствах связи, РЛС, а так же военной, авиационной и аэрокосмической отраслях промышленности).



Телефон: 8 (812) 309-75-97 (многоканальный)

Факс: 8 (812) 320-03-32

Электронная почта: [ocean@oceanchips.ru](mailto:ocean@oceanchips.ru)

Web: <http://oceanchips.ru/>

Адрес: 198099, г. Санкт-Петербург, ул. Калинина, д. 2, корп. 4, лит. А