

LMV931, LMV932

Single and Dual Low Voltage, Rail-to-Rail Input and Output, Operational Amplifiers

The LMV931 Single and LMV932 Dual are CMOS low-voltage operational amplifiers which can operate on single-sided power supplies (1.8 V to 5.0 V) with rail-to-rail input and output swing. Both devices come in small state-of-the-art packages and require very low quiescent current making them ideal for battery-operated, portable applications such as notebook computers and hand-held instruments. Rail-to-Rail operation provides improved signal-to-noise performance plus the small packages allow for closer placement to signal sources thereby reducing noise pickup.

The single LMV931 is offered in space saving SC70-5 package. The dual LMV932 is in either a Micro8 or SOIC package. These small packages are very beneficial for crowded PCB's.

Features

- Performance Specified on Single-Sided Power Supply: 1.8 V, 2.7 V, and 5 V
- Small Packages:
 - LMV931 in a SC-70
 - LMV932 in a Micro8 or SOIC-8
- No Output Crossover Distortion
- Extended Industrial Temperature Range: -40°C to $+125^{\circ}\text{C}$
- Low Quiescent Current 210 μA , Max Per Channel
- No Output Phase-Reversal from Overdriven Input
- These are Pb-Free Devices

Typical Applications

- Notebook Computers, Portable Battery-Operated Instruments, PDA's
- Active Filters, Low-Side Current Monitoring

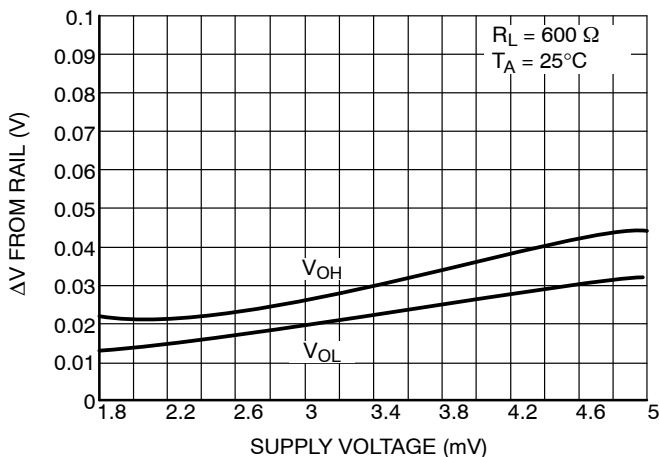

Figure 1. Output Voltage Swing vs. Supply Voltage



ON Semiconductor®

<http://onsemi.com>

MARKING DIAGRAMS

LMV931 (Single)

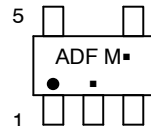
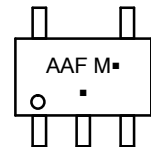

M = Date Code
▪ = Pb-Free Package

(*Note: Microdot may be in either location)

LMV932 (Dual)

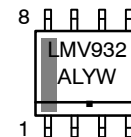
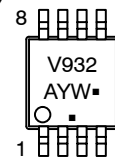

A = Assembly Location
Y = Year
L = Wafer Lot
W = Work Week
▪ = Pb-Free Package

(*Note: Microdot may be in either location)

ORDERING INFORMATION

See detailed ordering and shipping information in the package dimensions section on page 14 of this data sheet.

LMV931, LMV932

PIN CONNECTIONS

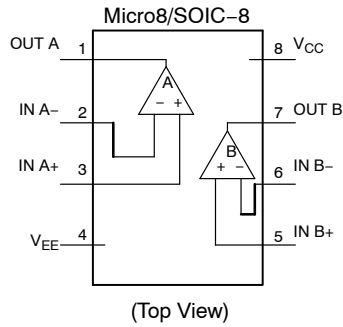
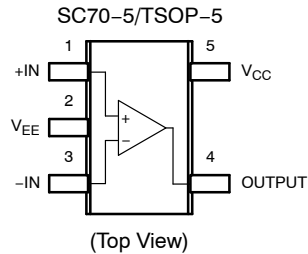

MAXIMUM RATINGS

Symbol	Rating	Value	Unit
V_S	Supply Voltage (Operating Range $V_S = 1.8\text{ V to }5.5\text{ V}$)	5.5	V
V_{IDR}	Input Differential Voltage	\pm Supply Voltage	V
V_{ICR}	Input Common Mode Voltage Range	$-0.5\text{ to }(V_{CC}) + 0.5$	V
	Maximum Input Current	10	mA
t_{SO}	Output Short Circuit (Note 1)	Continuous	
T_J	Maximum Junction Temperature (Operating Range $-40^\circ\text{C to }85^\circ\text{C}$)	150	$^\circ\text{C}$
θ_{JA}	Thermal Resistance:	SC-70 TSOP-5 Micro8	$^\circ\text{C/W}$
T_{stg}	Storage Temperature	$-65\text{ to }150$	$^\circ\text{C}$
	Mounting Temperature (Infrared or Convection $\leq 30\text{ sec}$)	260	$^\circ\text{C}$

Stresses exceeding Maximum Ratings may damage the device. Maximum Ratings are stress ratings only. Functional operation above the Recommended Operating Conditions is not implied. Extended exposure to stresses above the Recommended Operating Conditions may affect device reliability.

ESD data available upon request.

1. Continuous short-circuit operation to ground at elevated ambient temperature can result in exceeding the maximum allowed junction temperature of 150°C . Output currents in excess of 45 mA over long term may adversely affect reliability. Shorting output to either V_{CC} or V_{EE} will adversely affect reliability.

LMV931, LMV932

1.8 V DC ELECTRICAL CHARACTERISTICS (Note 2) Unless otherwise noted, all min/max limits are guaranteed for $T_A = 25^\circ\text{C}$, $V_S = 1.8\text{ V}$, $V_{CM} = V_S/2$, $V_O = V_S/2$ and $R_L > 1\text{ M}\Omega$. Typical specifications represent the most likely parametric norm.

Parameter	Symbol	Condition	Min	Typ	Max	Unit
Input Offset Voltage	V_{IO}	LMV931 (Single) (-40°C to $+125^\circ\text{C}$)		1	6	mV
		LMV932 (Dual) (-40°C to $+125^\circ\text{C}$)		1	7.5	
Input Offset Voltage Average Drift	TCV_{IO}			5.5		$\mu\text{V}/^\circ\text{C}$
Input Bias Current	I_B	-40°C to $+125^\circ\text{C}$		< 1		nA
Input Offset Current	I_{IO}	-40°C to $+125^\circ\text{C}$		< 1		nA
Supply Current (per Channel)	I_{CC}	In Active Mode		75	185	μA
		-40°C to $+125^\circ\text{C}$			205	
Common Mode Rejection Ratio	CMRR	$0\text{ V} \leq V_{CM} \leq 0.6\text{ V}$, $1.4\text{ V} \leq V_{CM} \leq 1.8\text{ V}$	50	70		dB
		-40°C to $+125^\circ\text{C}$	50			
		$-0.2\text{ V} \leq V_{CM} \leq 0\text{ V}$, $1.8\text{ V} \leq V_{CM} \leq 2\text{ V}$	50	70		
Power Supply Rejection Ratio	PSRR	$1.8\text{ V} \leq V^+ \leq 5\text{ V}$, $V_{CM} = 0.5\text{ V}$	50	70		dB
		-40°C to $+125^\circ\text{C}$	50			
Input Common-Mode Voltage Range	VCM	For CMRR $\geq 50\text{ dB}$ and $T_A = 25^\circ\text{C}$	$V_{EE} - 0.2$	-0.2 to 2.1	$V_{CC} + 0.2$	V
		For CMRR $\geq 50\text{ dB}$ and $T_A = -40^\circ\text{C}$ to $+85^\circ\text{C}$	V_{EE}		V_{CC}	
		For CMRR $\geq 50\text{ dB}$ and $T_A = -40^\circ\text{C}$ to $+125^\circ\text{C}$	$V_{EE} + 0.2$		$V_{CC} - 0.2$	
Large Signal Voltage Gain LMV931 (Single)	A_V	$R_L = 600\ \Omega$ to 0.9 V , $V_O = 0.2\text{ V}$ to 1.6 V , $V_{CM} = 0.5\text{ V}$	77	101		dB
		-40°C to $+125^\circ\text{C}$	73			
		$R_L = 2\text{ k}\Omega$ to 0.9 V , $V_O = 0.2\text{ V}$ to 1.6 V , $V_{CM} = 0.5\text{ V}$	80	105		
		-40°C to $+125^\circ\text{C}$	75			
Large Signal Voltage Gain LMV932 (Dual)	A_V	$R_L = 600\ \Omega$ to 0.9 V , $V_O = 0.2\text{ V}$ to 1.6 V , $V_{CM} = 0.5\text{ V}$	75	90		dB
		-40°C to $+125^\circ\text{C}$	72			
		$R_L = 2\text{ k}\Omega$ to 0.9 V , $V_O = 0.2\text{ V}$ to 1.6 V , $V_{CM} = 0.5\text{ V}$	78	100		
		-40°C to $+125^\circ\text{C}$	75			
Output Swing	V_{OH}	$R_L = 600\ \Omega$ to 0.9 V , $V_{IN} = \pm 100\text{ mV}$	1.65	1.72		V
		-40°C to $+125^\circ\text{C}$	1.63			
	V_{OL}	$R_L = 600\ \Omega$ to 0.9 V , $V_{IN} = \pm 100\text{ mV}$		0.077	0.105	
		-40°C to $+125^\circ\text{C}$			0.12	
	V_{OH}	$R_L = 2\text{ k}\Omega$ to 0.9 V , $V_{IN} = \pm 100\text{ mV}$	1.75	1.77		
		-40°C to $+125^\circ\text{C}$	1.74			
	V_{OL}	$R_L = 2\text{ k}\Omega$ to 0.9 V , $V_{IN} = \pm 100\text{ mV}$		0.24	0.035	
		-40°C to $+125^\circ\text{C}$			0.04	
Output Short Circuit Current	I_O	Sourcing, $V_O = 0\text{ V}$, $V_{IN} = +100\text{ mV}$	4.0	30		mA
		-40°C to $+125^\circ\text{C}$	3.3			
		Sinking, $V_O = 1.8\text{ V}$, $V_{IN} = -100\text{ mV}$	7.0	60		
		-40°C to $+125^\circ\text{C}$	5.0			

2. Guaranteed by design and/or characterization.

LMV931, LMV932

1.8 V AC ELECTRICAL CHARACTERISTICS Unless otherwise specified, all limits are guaranteed for $T_A = 25^\circ\text{C}$, $V_S = 1.8\text{ V}$, $V_{CM} = V_S/2$, $V_O = V_S/2$ and $R_L > 1\text{ M}\Omega$. Typical specifications represent the most likely parametric norm. Min/Max specifications are guaranteed by testing, characterization, or statistical analysis.

Parameter	Symbol	Condition	Min	Typ	Max	Unit
Slew Rate	SR	(Note 3)		0.35		V/ μS
Gain Bandwidth Product	GBWP			1.4		MHz
Phase Margin	Θ_m			67		$^\circ$
Gain Margin	Gm			7		dB
Input-Referred Voltage Noise	e_n	$f = 50\text{ kHz}$, $V_{CM} = 0.5\text{ V}$		60		nV/ $\sqrt{\text{Hz}}$
Total Harmonic Distortion	THD	$f = 1\text{ kHz}$, $A_V = +1$, $R_L = 600\ \Omega$, $V_O = 1\text{ V}_{PP}$		0.023		%
Amplifier-to-Amplifier Isolation		(Note 4)		123		dB

3. Connected as voltage follower with input step from V_{EE} to V_{CC} . Number specified is the slower of the positive and negative slew rates.
4. Input referred, $R_L = 100\text{ k}\Omega$ connected to $V_S/2$. Each amp excited in turn with 1 kHz to produce $V_O = 3\text{ V}_{PP}$. (For Supply Voltages $< 3\text{ V}$, $V_O = V_{CC}$).

LMV931, LMV932

2.7 V DC ELECTRICAL CHARACTERISTICS (Note 5) Unless otherwise noted, all min/max limits are guaranteed for $T_A = 25^\circ\text{C}$, $V_S = 2.7\text{ V}$, $V_{CM} = V_S/2$, $V_O = V_S/2$ and $R_L > 1\text{ M}\Omega$. Typical specifications represent the most likely parametric norm.

Parameter	Symbol	Condition	Min	Typ	Max	Unit
Input Offset Voltage	V_{IO}	LMV931 (Single) (-40°C to $+125^\circ\text{C}$)		1	6	mV
		LMV932 (Dual) (-40°C to $+125^\circ\text{C}$)		1	7.5	
Input Offset Voltage Average Drift	TCV_{IO}			5.5		$\mu\text{V}/^\circ\text{C}$
Input Bias Current	I_B	-40°C to $+125^\circ\text{C}$		< 1		nA
Input Offset Current	I_{IO}	-40°C to $+125^\circ\text{C}$		< 1		nA
Supply Current (per Channel)	I_{CC}	In Active Mode		80	190	μA
		-40°C to $+125^\circ\text{C}$			210	
Common Mode Rejection Ratio	CMRR	$0\text{ V} \leq V_{CM} \leq 1.5\text{ V}$, $2.3\text{ V} \leq V_{CM} \leq 2.7\text{ V}$	50	70		dB
		-40°C to $+125^\circ\text{C}$	50			
		$-0.2\text{ V} \leq V_{CM} \leq 0\text{ V}$, $2.7\text{ V} \leq V_{CM} \leq 2.9\text{ V}$	50	70		
Power Supply Rejection Ratio	PSRR	$1.8\text{ V} \leq V^+ \leq 5\text{ V}$, $V_{CM} = 0.5\text{ V}$	50	70		dB
		-40°C to $+125^\circ\text{C}$	50			
Input Common-Mode Voltage Range	VCM	For CMRR $\geq 50\text{ dB}$ and $T_A = 25^\circ\text{C}$	$V_{EE} - 0.2$	-0.2 to 3.0	$V_{CC} + 0.2$	V
		For CMRR $\geq 50\text{ dB}$ and $T_A = -40^\circ\text{C}$ to $+85^\circ\text{C}$	V_{EE}		V_{CC}	
		For CMRR $\geq 50\text{ dB}$ and $T_A = -40^\circ\text{C}$ to $+125^\circ\text{C}$	$V_{EE} + 0.2$		$V_{CC} - 0.2$	
Large Signal Voltage Gain LMV931 (Single)	A_V	$R_L = 600\ \Omega$ to 1.35 V , $V_O = 0.2\text{ V}$ to 2.5 V	87	104		dB
		-40°C to $+125^\circ\text{C}$	86			
		$R_L = 2\text{ k}\Omega$ to 1.35 V , $V_O = 0.2\text{ V}$ to 2.5 V	92	110		
		-40°C to $+125^\circ\text{C}$	91			
Large Signal Voltage Gain LMV932 (Dual)	A_V	$R_L = 600\ \Omega$ to 1.35 V , $V_O = 0.2\text{ V}$ to 2.5 V	78	90		dB
		-40°C to $+125^\circ\text{C}$	75			
		$R_L = 2\text{ k}\Omega$ to 1.35 V , $V_O = 0.2\text{ V}$ to 2.5 V	81	100		
		-40°C to $+125^\circ\text{C}$	78			
Output Swing	V_{OH}	$R_L = 600\ \Omega$ to 1.35 V , $V_{IN} = \pm 100\text{ mV}$	2.55	2.62		V
		-40°C to $+125^\circ\text{C}$	2.53			
	V_{OL}	$R_L = 600\ \Omega$ to 1.35 V , $V_{IN} = \pm 100\text{ mV}$		0.083	0.11	
		-40°C to $+125^\circ\text{C}$			0.13	
	V_{OH}	$R_L = 2\text{ k}\Omega$ to 1.35 V , $V_{IN} = \pm 100\text{ mV}$	2.65	2.675		
		-40°C to $+125^\circ\text{C}$	2.64			
	V_{OL}	$R_L = 2\text{ k}\Omega$ to 1.35 V , $V_{IN} = \pm 100\text{ mV}$		0.025	0.04	
		-40°C to $+125^\circ\text{C}$			0.045	
Output Short Circuit Current	I_O	Sourcing, $V_o = 0\text{ V}$, $V_{IN} = \pm 100\text{ mV}$	20	65		mA
		-40°C to $+125^\circ\text{C}$	15			
		Sinking, $V_o = 0\text{ V}$, $V_{IN} = -100\text{ mV}$	18	75		
		-40°C to $+125^\circ\text{C}$	12			

5. Guaranteed by design and/or characterization.

LMV931, LMV932

2.7 V AC ELECTRICAL CHARACTERISTICS Unless otherwise specified, all limits are guaranteed for $T_A = 25^\circ\text{C}$, $V_S = 2.7\text{ V}$, $V_{CM} = V_S/2$, $V_O = V_S/2$ and $R_L > 1\text{ M}\Omega$. Typical specifications represent the most likely parametric norm. Min/Max specifications are guaranteed by testing, characterization, or statistical analysis.

Parameter	Symbol	Condition	Min	Typ	Max	Unit
Slew Rate	SR	(Note 6)		0.4		V/ μS
Gain Bandwidth Product	GBWP			1.4		MHz
Phase Margin	Θ_m			70		$^\circ$
Gain Margin	Gm			7.5		dB
Input-Referred Voltage Noise	e_n	$f = 50\text{ kHz}$, $V_{CM} = 1.0\text{ V}$		57		nV/ $\sqrt{\text{Hz}}$
Total Harmonic Distortion	THD	$f = 1\text{ kHz}$, $A_V = +1$, $R_L = 600\ \Omega$, $V_O = 1\text{ V}_{PP}$		0.022		%
Amplifier-to-Amplifier Isolation		(Note 7)		123		dB

6. Connected as voltage follower with input step from V_{EE} to V_{CC} . Number specified is the slower of the positive and negative slew rates.
 7. Input referred, $R_L = 100\text{ k}\Omega$ connected to $V_S/2$. Each amp excited in turn with 1 kHz to produce $V_O = 3\text{ V}_{PP}$. (For Supply Voltages $< 3\text{ V}$, $V_O = V_{CC}$).

LMV931, LMV932

5 V DC ELECTRICAL CHARACTERISTICS (Note 8) Unless otherwise noted, all min/max limits are guaranteed for $T_A = 25^\circ\text{C}$, $V_S = 5\text{ V}$, $V_{CM} = V_S/2$, $V_O = V_S/2$ and $R_L > 1\text{ M}\Omega$. Typical specifications represent the most likely parametric norm.

Parameter	Symbol	Condition	Min	Typ	Max	Unit
Input Offset Voltage	V_{IO}	LMV931 (Single) (-40°C to $+125^\circ\text{C}$)		1	6	mV
		LMV932 (Dual) (-40°C to $+125^\circ\text{C}$)		1	7.5	
Input Offset Voltage Average Drift	TCV_{IO}			5.5		$\mu\text{V}/^\circ\text{C}$
Input Bias Current	I_B	-40°C to $+125^\circ\text{C}$		< 1		nA
Input Offset Current	I_{IO}	-40°C to $+125^\circ\text{C}$		< 1		nA
Supply Current (per Channel)	I_{CC}	In Active Mode		95	210	μA
		-40°C to $+125^\circ\text{C}$			230	
Common-Mode Rejection Ratio	CMRR	$0\text{ V} \leq V_{CM} \leq 3.8\text{ V}$, $4.6\text{ V} \leq V_{CM} \leq 5.0\text{ V}$	50	70		dB
		-40°C to $+125^\circ\text{C}$	50			
		$-0.2\text{ V} \leq V_{CM} \leq 0\text{ V}$, $5.0\text{ V} \leq V_{CM} \leq 5.2\text{ V}$	50	70		
Power Supply Rejection Ratio	PSRR	$1.8\text{ V} \leq V^+ \leq 5\text{ V}$, $V_{CM} = 0.5\text{ V}$	50	70		dB
		-40°C to $+125^\circ\text{C}$	50			
Input Common-Mode Voltage Range	VCM	For CMRR $\geq 50\text{ dB}$ and $T_A = 25^\circ\text{C}$	$V_{EE} - 0.2$	-0.2 to 5.3	$V_{CC} + 0.2$	V
		For CMRR $\geq 50\text{ dB}$ and $T_A = -40^\circ\text{C}$ to $+85^\circ\text{C}$	V_{EE}		V_{CC}	
		For CMRR $\geq 50\text{ dB}$ and $T_A = -40^\circ\text{C}$ to $+125^\circ\text{C}$	$V_{EE} + 0.3$		$V_{CC} - 0.3$	
Large Signal Voltage Gain LMV931 (Single)	A_V	$R_L = 600\ \Omega$ to 2.5 V , $V_O = 0.2\text{ V}$ to 4.8 V	88	102		dB
		-40°C to $+125^\circ\text{C}$	87			
		$R_L = 2\text{ k}\Omega$ to 2.5 V , $V_O = 0.2\text{ V}$ to 4.8 V	94	113		
		-40°C to $+125^\circ\text{C}$	93			
Large Signal Voltage Gain LMV932 (Dual)	A_V	$R_L = 600\ \Omega$ to 2.5 V , $V_O = 0.2\text{ V}$ to 4.8 V	81	90		dB
		-40°C to $+125^\circ\text{C}$	78			
		$R_L = 2\text{ k}\Omega$ to 2.5 V , $V_O = 0.2\text{ V}$ to 4.8 V	85	100		
		-40°C to $+125^\circ\text{C}$	82			
Output Swing	V_{OH}	$R_L = 600\ \Omega$ to 2.5 V , $V_{IN} = \pm 100\text{ mV}$	4.855	4.89		V
		-40°C to $+125^\circ\text{C}$	4.835			
	V_{OL}	$R_L = 600\ \Omega$ to 2.5 V , $V_{IN} = \pm 100\text{ mV}$		0.12	0.16	
		-40°C to $+125^\circ\text{C}$			0.18	
	V_{OH}	$R_L = 2\text{ k}\Omega$ to 2.5 V , $V_{IN} = \pm 100\text{ mV}$	4.945	4.967		
		-40°C to $+125^\circ\text{C}$	4.935			
	V_{OL}	$R_L = 2\text{ k}\Omega$ to 2.5 V , $V_{IN} = \pm 100\text{ mV}$		0.037	0.065	
		-40°C to $+125^\circ\text{C}$			0.075	
Output Short-Circuit Current	I_O	Sourcing, $V_O = 0\text{ V}$, $V_{IN} = +100\text{ mV}$	55	65		mA
		-40°C to $+125^\circ\text{C}$	45			
		Sinking, $V_O = 5\text{ V}$, $V_{IN} = -100\text{ mV}$	58	80		
		-40°C to $+125^\circ\text{C}$	45			

8. Guaranteed by design and/or characterization.

LMV931, LMV932

5 V AC ELECTRICAL CHARACTERISTICS Unless otherwise specified, all limits are guaranteed for $T_A = 25^\circ\text{C}$, $V_S = 5\text{ V}$, $V_{CM} = V_S/2$, $V_O = V_S/2$ and $R_L > 1\text{ M}\Omega$. Typical specifications represent the most likely parametric norm.

Parameter	Symbol	Condition	Min	Typ	Max	Unit
Slew Rate	SR	(Note 9)		0.48		V/ μS
Gain Bandwidth Product	GBWP			1.5		MHz
Phase Margin	Θ_m			65		$^\circ$
Gain Margin	Gm			8		dB
Input-Referred Voltage Noise	e_n	$f = 50\text{ kHz}$, $V_{CM} = 2\text{ V}$		50		nV/ $\sqrt{\text{Hz}}$
Total Harmonic Distortion	THD	$f = 1\text{ kHz}$, $A_V = +1$, $R_L = 600\ \Omega$, $V_O = 1\text{ V}_{PP}$		0.022		%
Amplifier-to-Amplifier Isolation		(Note 10)		123		dB

9. Connected as voltage follower with input step from V_{EE} to V_{CC} . Number specified is the slower of the positive and negative slew rates.

10. Input referred, $R_L = 100\text{ k}\Omega$ connected to $V_S/2$. Each amp excited in turn with 1 kHz to produce $V_O = 3\text{ V}_{PP}$. (For Supply Voltages $< 3\text{ V}$, $V_O = V_{CC}$).

LMV931, LMV932

TYPICAL CHARACTERISTICS

($T_A = 25^\circ\text{C}$ and $V_S = 5\text{ V}$ unless otherwise specified)

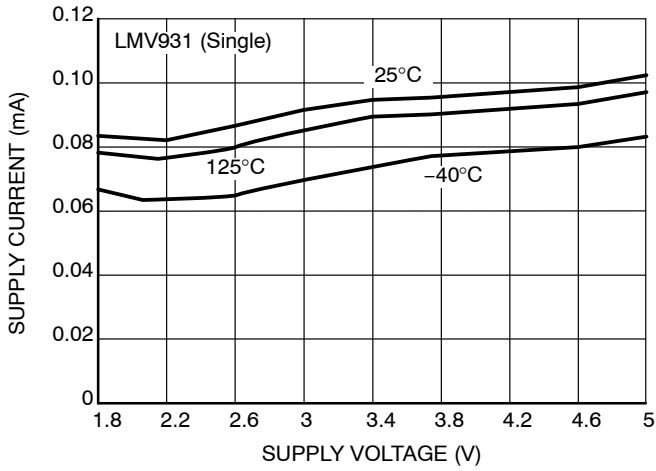

Figure 2. Supply Current vs. Supply Voltage

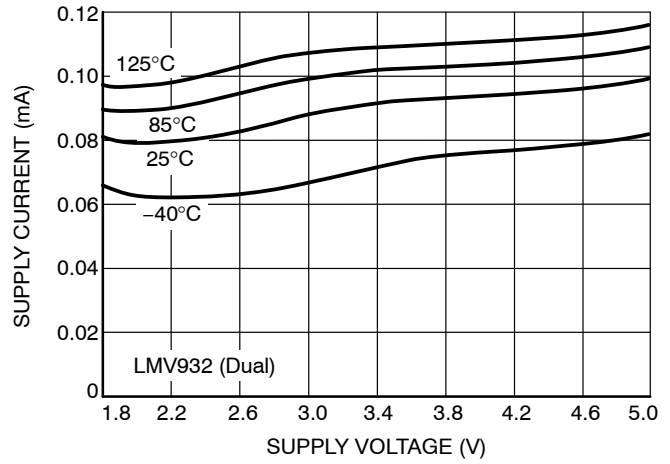

Figure 3. Supply Current vs. Supply Voltage

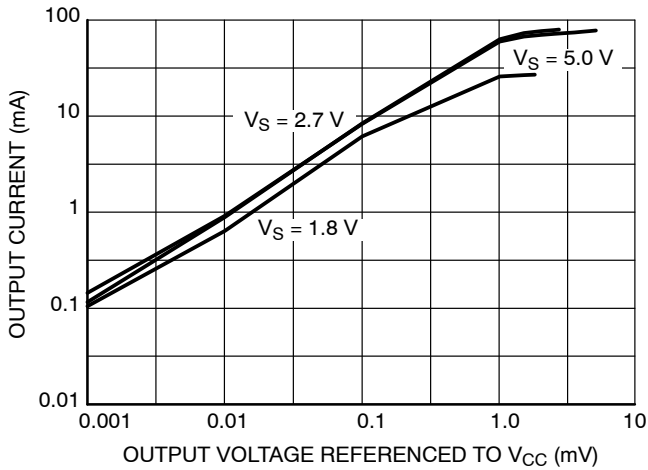

Figure 4. Sourcing Current vs. Output Voltage
($T_A = 25^\circ\text{C}$)

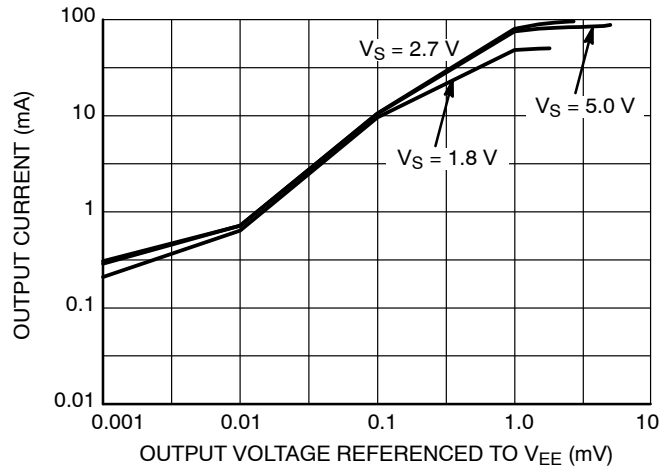

Figure 5. Sinking Current vs. Output Voltage
($T_A = 25^\circ\text{C}$)

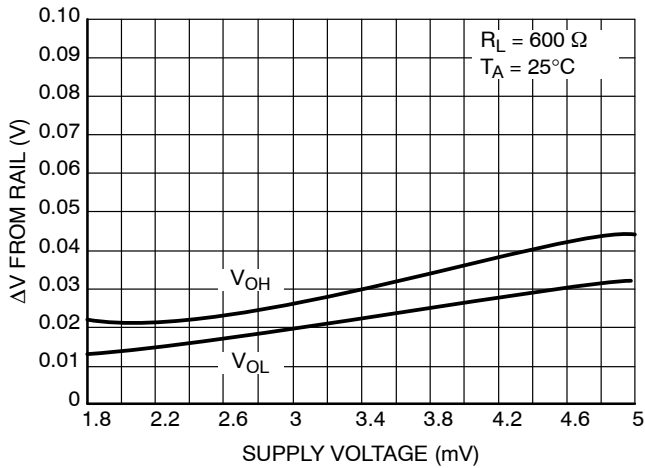

Figure 6. Output Voltage Swing vs. Supply Voltage

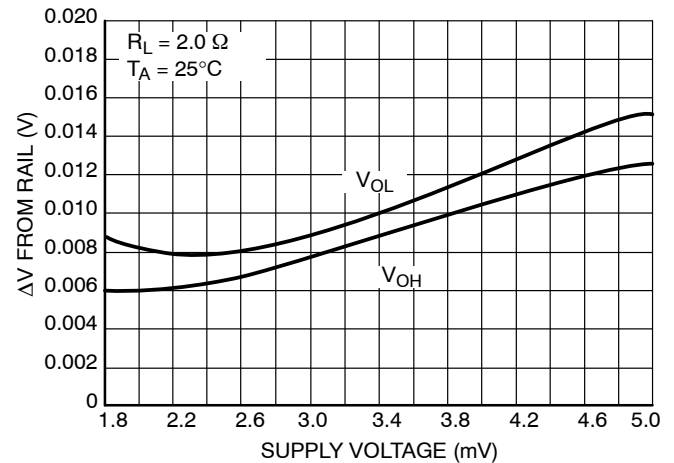

Figure 7. Output Voltage vs. Supply Voltage

LMV931, LMV932

TYPICAL CHARACTERISTICS

($T_A = 25^\circ\text{C}$ and $V_S = 5\text{ V}$ unless otherwise specified)

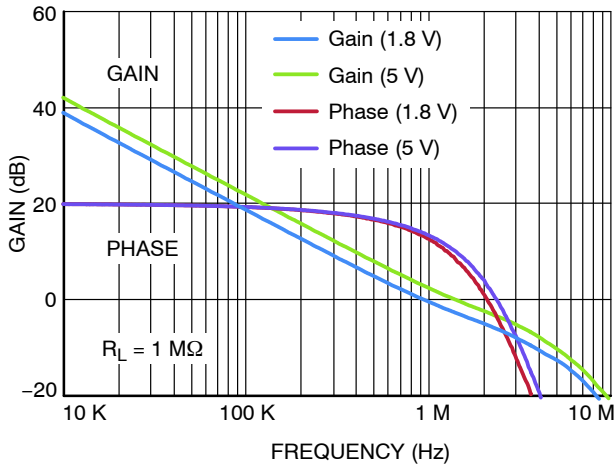

Figure 8. Open Loop Gain and Phase

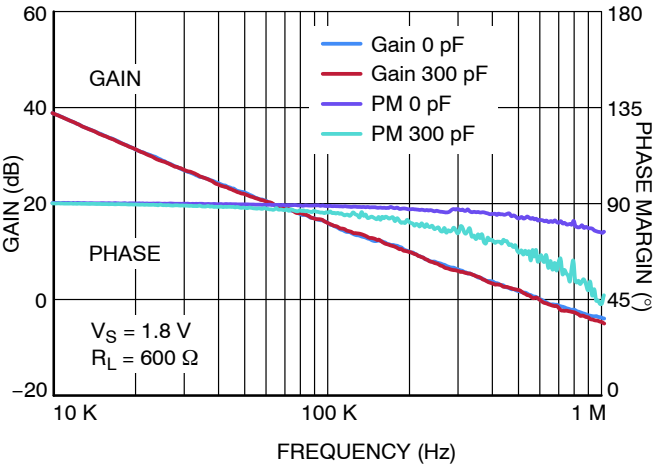

Figure 9. Frequency Response vs. CL

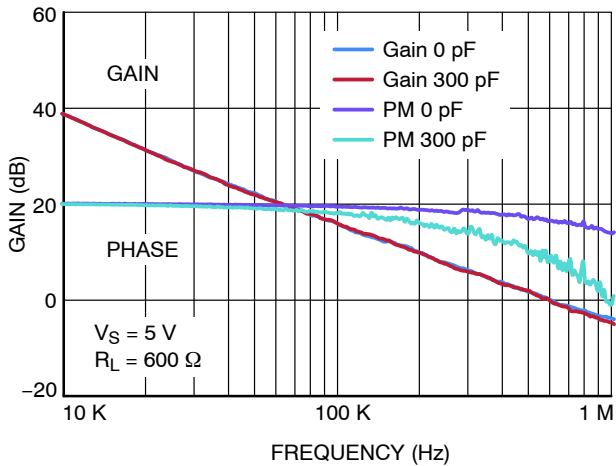

Figure 10. Frequency Response vs. CL

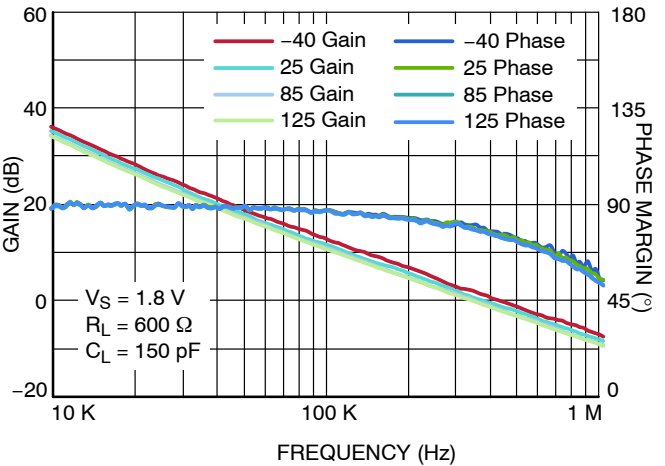

Figure 11. Gain and Phase vs. Temp

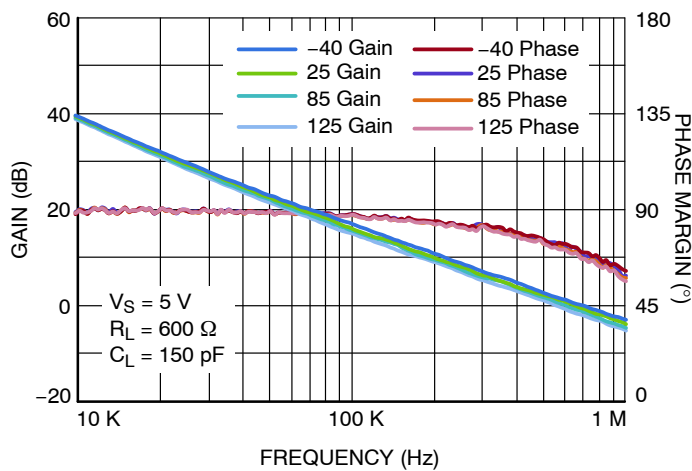

Figure 12. Gain and Phase vs. Temp

LMV931, LMV932

TYPICAL CHARACTERISTICS

($T_A = 25^\circ\text{C}$ and $V_S = 5\text{ V}$ unless otherwise specified)

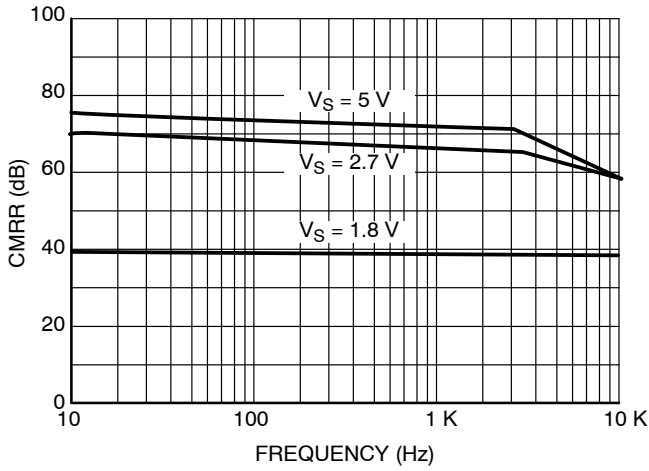

Figure 13. CMRR vs. Frequency

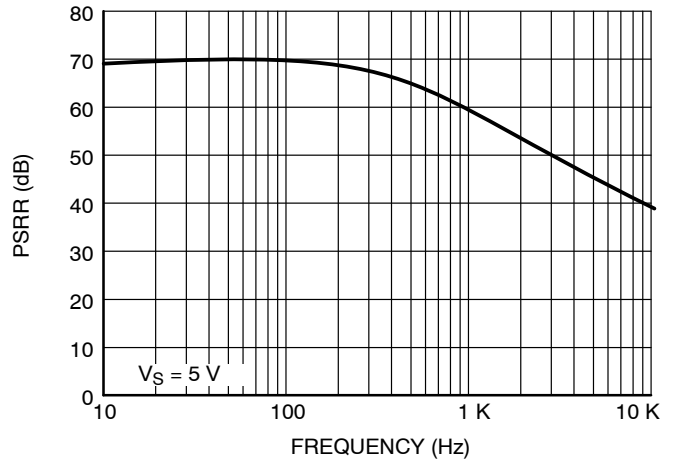

Figure 14. PSRR vs. Frequency

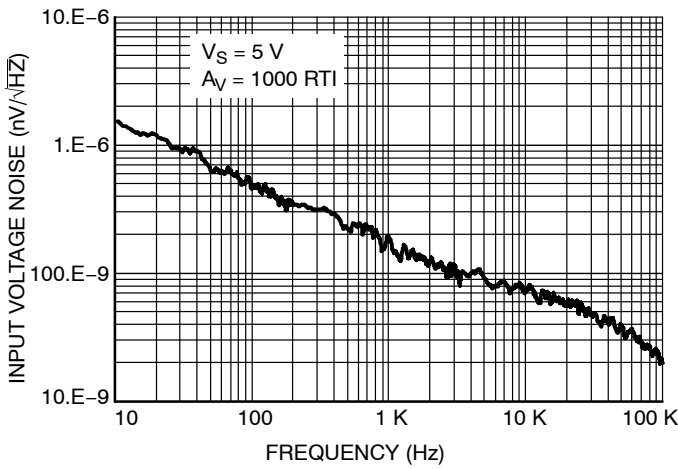

Figure 15. Input Voltage Noise vs. Frequency

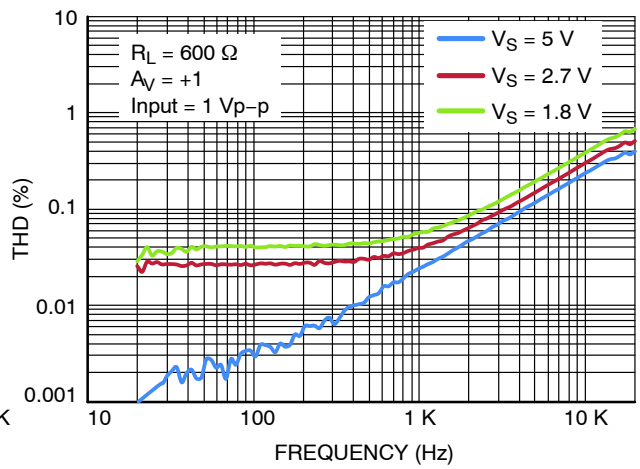

Figure 16. THD vs. Frequency

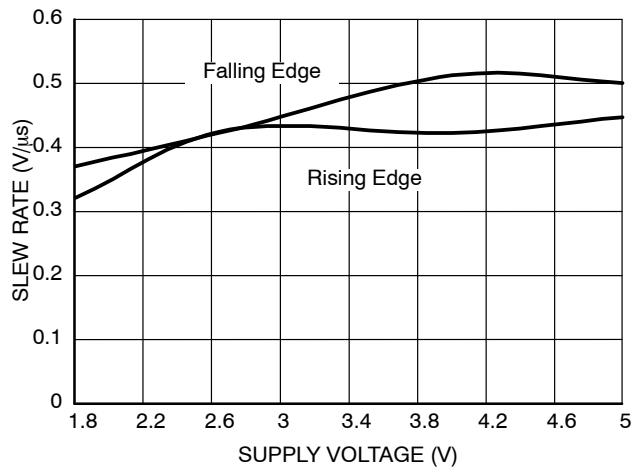

Figure 17. Slew Rate vs. Supply Voltage

LMV931, LMV932

TYPICAL CHARACTERISTICS

($T_A = 25^\circ\text{C}$ and $V_S = 5\text{ V}$ unless otherwise specified)

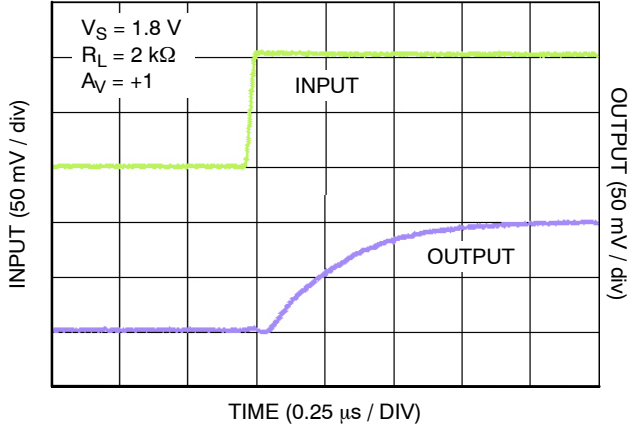

Figure 18. Small Signal Transient Response

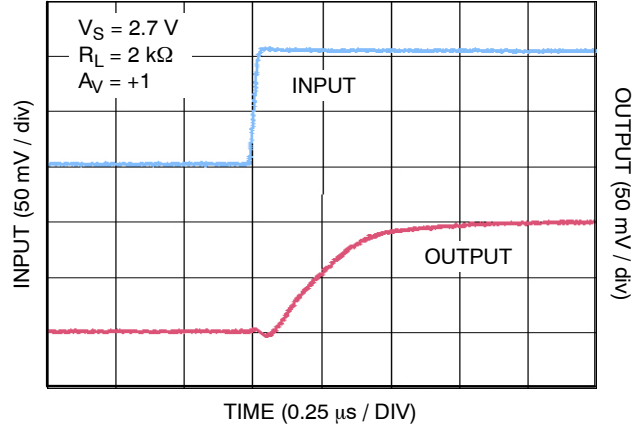

Figure 19. Small Signal Transient Response

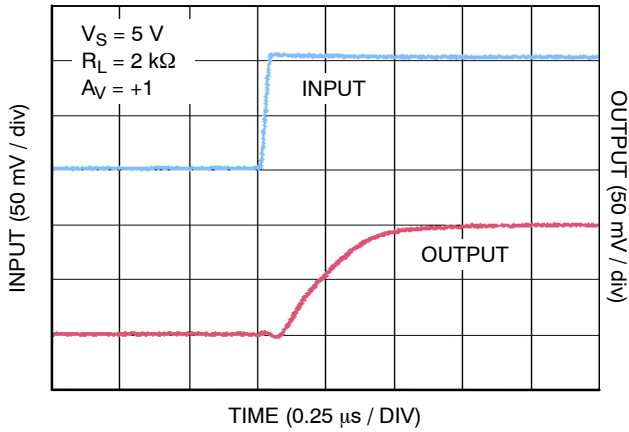

Figure 20. Small Signal Transient Response

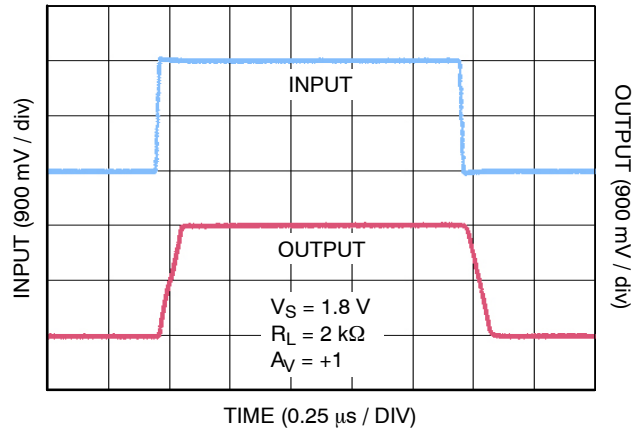

Figure 21. Large Signal Transient Response

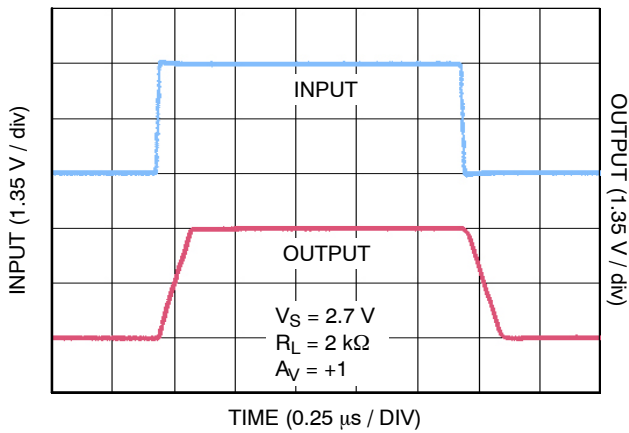

Figure 22. Large Signal Transient Response

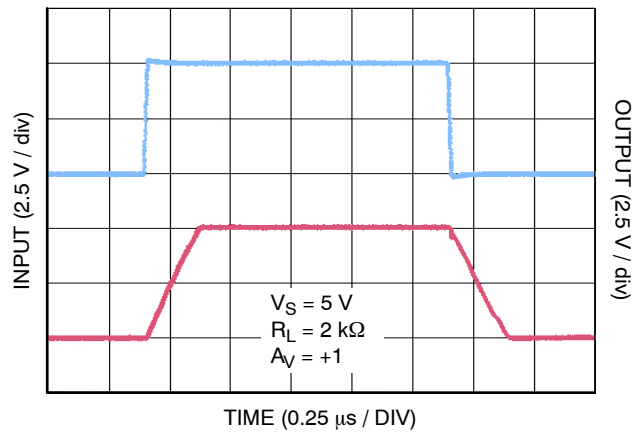

Figure 23. Large Signal Transient Response

LMV931, LMV932

TYPICAL CHARACTERISTICS

($T_A = 25^\circ\text{C}$ and $V_S = 5\text{ V}$ unless otherwise specified)

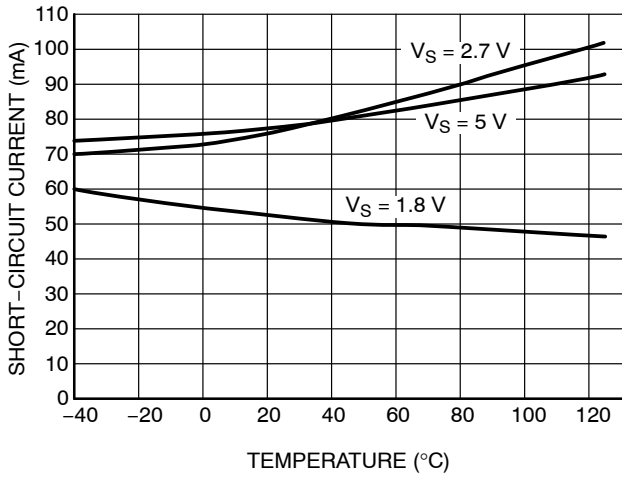

Figure 24. Short-Circuit vs. Temperature (Sinking)

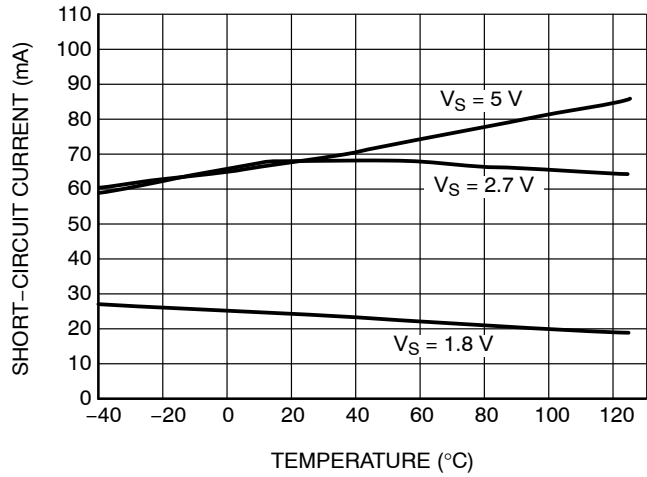

Figure 25. Short-Circuit vs. Temperature (Sourcing)

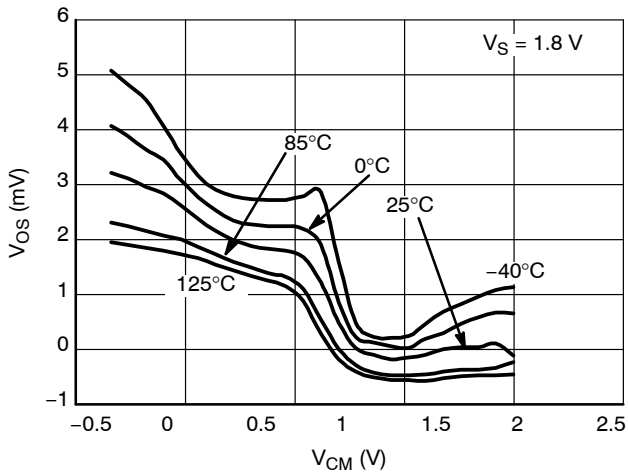

Figure 26. Offset Voltage vs. Common Mode Range V_{DD}

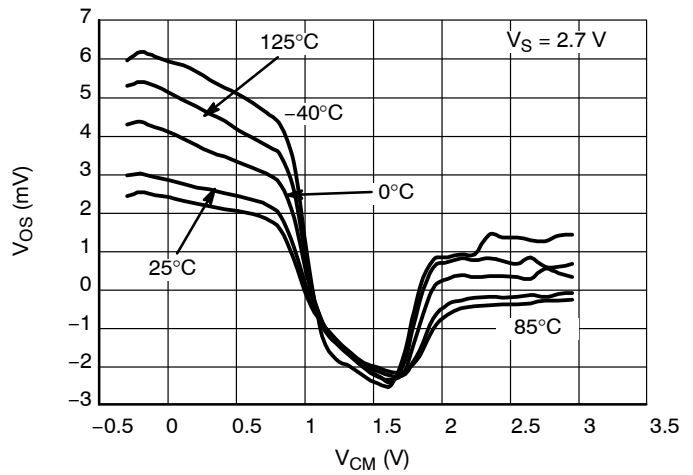

Figure 27. Offset Voltage vs. Common Mode Range

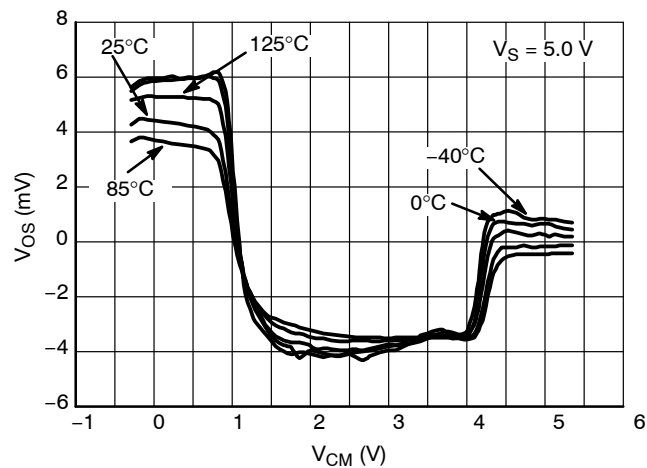

Figure 28. Offset Voltage vs. Common Mode Range

LMV931, LMV932

APPLICATION INFORMATION

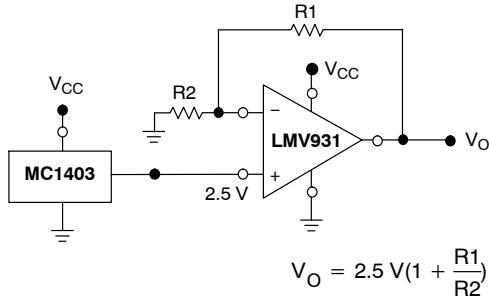

Figure 29. Voltage Reference

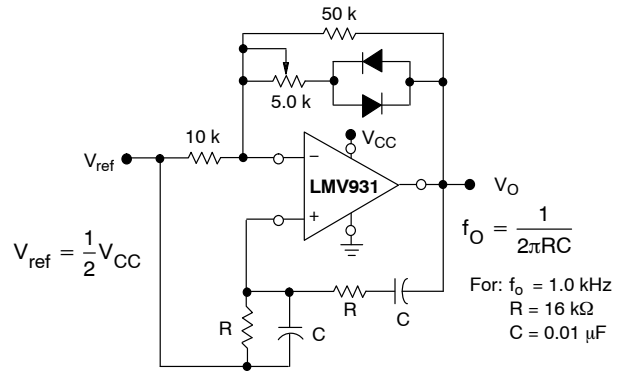

Figure 30. Wien Bridge Oscillator

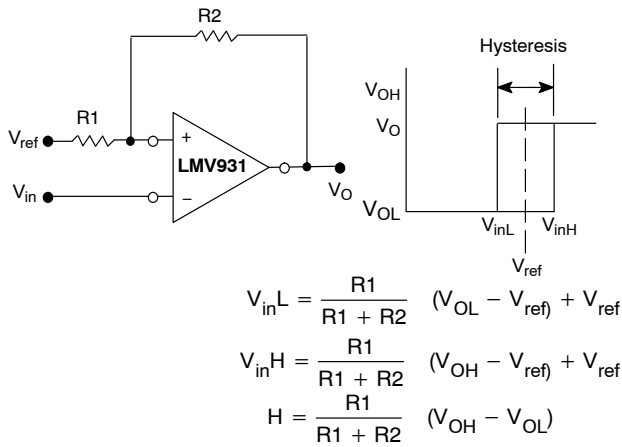
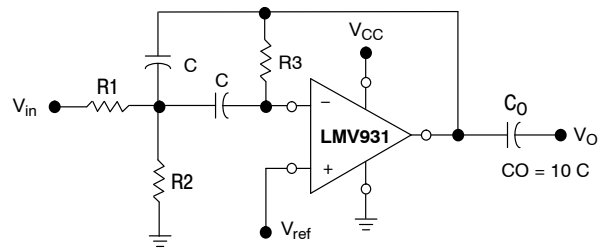

Figure 31. Comparator with Hysteresis



Given: f_o = center frequency
 $A(f_o)$ = gain at center frequency

Choose value f_o, C
 Then: $R3 = \frac{Q}{\pi f_o C}$
 $R1 = \frac{R3}{2 A(f_o)}$
 $R2 = \frac{R1 R3}{4Q^2 R1 - R3}$

For less than 10% error from operational amplifier,
 $((Q_o f_o)/BW) < 0.1$ where f_o and BW are expressed in Hz.
 If source impedance varies, filter may be preceded with
 voltage follower buffer to stabilize filter parameters.

Figure 32. Multiple Feedback Bandpass Filter

ORDERING INFORMATION

Order Number	Number of Channels	Number of Pins	Package Type	Shipping†
LMV931SQ3T2G	Single	5	SC70-5 (Pb-Free)	3000 / Tape & Reel
LMV931SN3T1G	Single	5	TSOP-5 (Pb-Free)	3000 / Tape & Reel
LMV932DMR2G*	Dual	8	Micro8 (Pb-Free)	4000 / Tape & Reel
LMV932DR2G	Dual	8	SOIC-8 (Pb-Free)	2500 / Tape & Reel

†For information on tape and reel specifications, including part orientation and tape sizes, please refer to our Tape and Reel Packaging Specifications Brochure, BRD8011/D.

*Consult Sales.

LMV931, LMV932

PACKAGE DIMENSIONS

SC-88A, SOT-353, SC-70
CASE 419A-02
ISSUE J

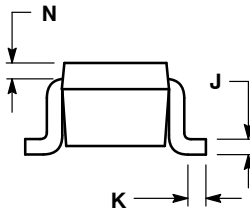
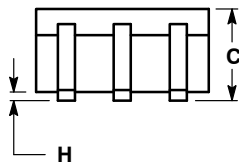
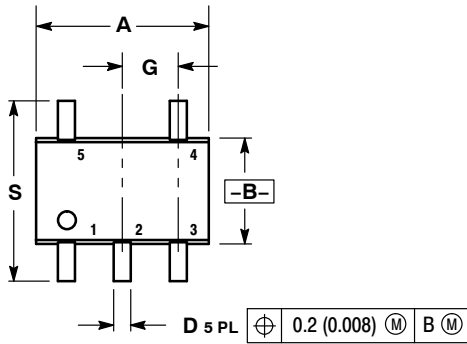

NOTES:

1. DIMENSIONING AND TOLERANCING PER ANSI Y14.5M, 1982.
2. CONTROLLING DIMENSION: INCH.
3. 419A-01 OBSOLETE. NEW STANDARD 419A-02.
4. DIMENSIONS A AND B DO NOT INCLUDE MOLD FLASH, PROTRUSIONS, OR GATE BURRS.

DIM	INCHES		MILLIMETERS	
	MIN	MAX	MIN	MAX
A	0.071	0.087	1.80	2.20
B	0.045	0.053	1.15	1.35
C	0.031	0.043	0.80	1.10
D	0.004	0.012	0.10	0.30
G	0.026 BSC		0.65 BSC	
H	---	0.004	---	0.10
J	0.004	0.010	0.10	0.25
K	0.004	0.012	0.10	0.30
N	0.008 REF		0.20 REF	
S	0.079	0.087	2.00	2.20

LMV931, LMV932

PACKAGE DIMENSIONS

TSOP-5 CASE 483-02 ISSUE H

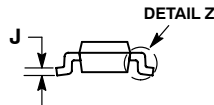
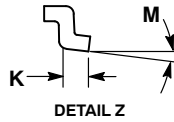
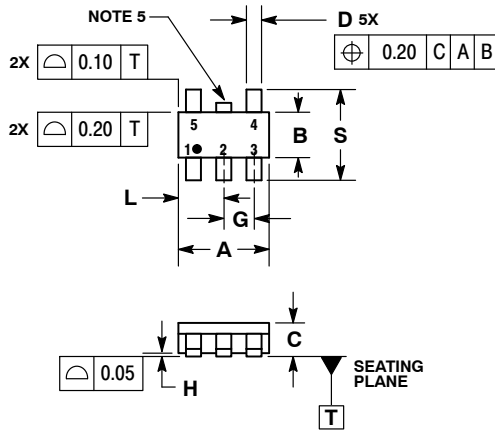

NOTES:

1. DIMENSIONING AND TOLERANCING PER ASME Y14.5M, 1994.
2. CONTROLLING DIMENSION: MILLIMETERS.
3. MAXIMUM LEAD THICKNESS INCLUDES LEAD FINISH THICKNESS. MINIMUM LEAD THICKNESS IS THE MINIMUM THICKNESS OF BASE MATERIAL.
4. DIMENSIONS A AND B DO NOT INCLUDE MOLD FLASH, PROTRUSIONS, OR GATE BURRS.
5. OPTIONAL CONSTRUCTION: AN ADDITIONAL TRIMMED LEAD IS ALLOWED IN THIS LOCATION. TRIMMED LEAD NOT TO EXTEND MORE THAN 0.2 FROM BODY.

DIM	MILLIMETERS	
	MIN	MAX
A	3.00 BSC	
B	1.50 BSC	
C	0.90	1.10
D	0.25	0.50
G	0.95 BSC	
H	0.01	0.10
J	0.10	0.26
K	0.20	0.60
L	1.25	1.55
M	0°	10°
S	2.50	3.00

SOLDERING FOOTPRINT*

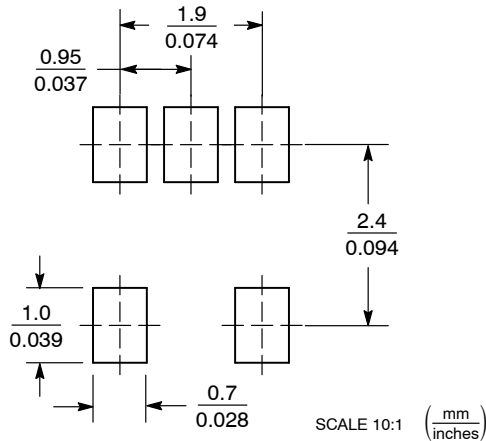

*For additional information on our Pb-Free strategy and soldering details, please download the ON Semiconductor Soldering and Mounting Techniques Reference Manual, SOLDERRM/D.

LMV931, LMV932

PACKAGE DIMENSIONS

Micro8™
CASE 846A-02
ISSUE H

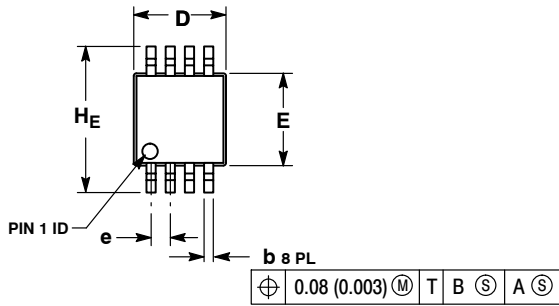

NOTES:

1. DIMENSIONING AND TOLERANCING PER ANSI Y14.5M, 1982.
2. CONTROLLING DIMENSION: MILLIMETER.
3. DIMENSION A DOES NOT INCLUDE MOLD FLASH, PROTRUSIONS OR GATE BURRS. MOLD FLASH, PROTRUSIONS OR GATE BURRS SHALL NOT EXCEED 0.15 (0.006) PER SIDE.
4. DIMENSION B DOES NOT INCLUDE INTERLEAD FLASH OR PROTRUSION. INTERLEAD FLASH OR PROTRUSION SHALL NOT EXCEED 0.25 (0.010) PER SIDE.
5. 846A-01 OBSOLETE, NEW STANDARD 846A-02.

DIM	MILLIMETERS			INCHES		
	MIN	NOM	MAX	MIN	NOM	MAX
A	---	---	1.10	---	---	0.043
A1	0.05	0.08	0.15	0.002	0.003	0.006
b	0.25	0.33	0.40	0.010	0.013	0.016
c	0.13	0.18	0.23	0.005	0.007	0.009
D	2.90	3.00	3.10	0.114	0.118	0.122
E	2.90	3.00	3.10	0.114	0.118	0.122
e	0.65 BSC			0.026 BSC		
L	0.40	0.55	0.70	0.016	0.021	0.028
HE	4.75	4.90	5.05	0.187	0.193	0.199

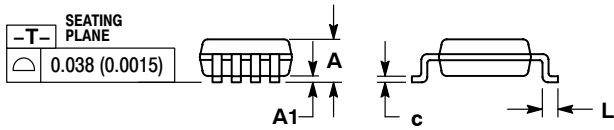

SOLDERING FOOTPRINT*

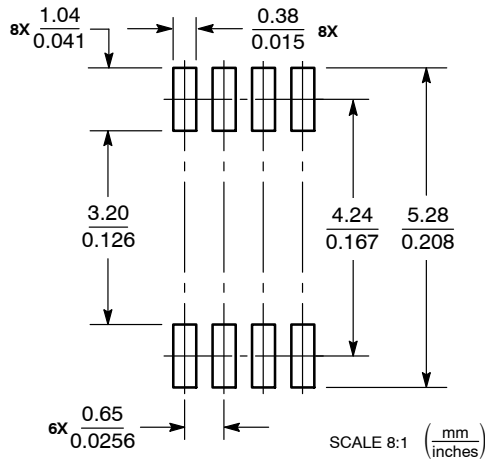

*For additional information on our Pb-Free strategy and soldering details, please download the ON Semiconductor Soldering and Mounting Techniques Reference Manual, SOLDERRM/D.

LMV931, LMV932

PACKAGE DIMENSIONS

SOIC-8 NB CASE 751-07 ISSUE AK

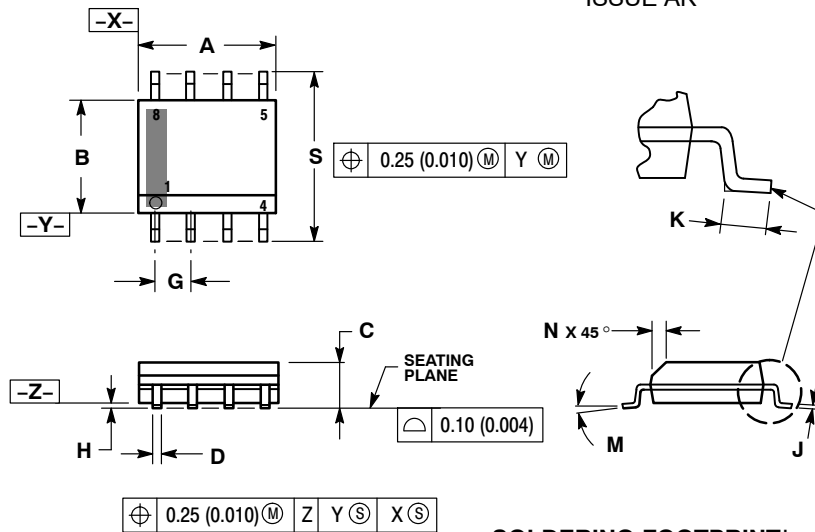

NOTES:

- DIMENSIONING AND TOLERANCING PER ANSI Y14.5M, 1982.
- CONTROLLING DIMENSION: MILLIMETER.
- DIMENSION A AND B DO NOT INCLUDE MOLD PROTRUSION.
- MAXIMUM MOLD PROTRUSION 0.15 (0.006) PER SIDE.
- DIMENSION D DOES NOT INCLUDE DAMBAR PROTRUSION. ALLOWABLE DAMBAR PROTRUSION SHALL BE 0.127 (0.005) TOTAL IN EXCESS OF THE D DIMENSION AT MAXIMUM MATERIAL CONDITION.
- 751-01 THRU 751-06 ARE OBSOLETE. NEW STANDARD IS 751-07.

DIM	MILLIMETERS		INCHES	
	MIN	MAX	MIN	MAX
A	4.80	5.00	0.189	0.197
B	3.80	4.00	0.150	0.157
C	1.35	1.75	0.053	0.069
D	0.33	0.51	0.013	0.020
G	1.27 BSC		0.050 BSC	
H	0.10	0.25	0.004	0.010
J	0.19	0.25	0.007	0.010
K	0.40	1.27	0.016	0.050
M	0°	8°	0°	8°
N	0.25	0.50	0.010	0.020
S	5.80	6.20	0.228	0.244

SOLDERING FOOTPRINT*

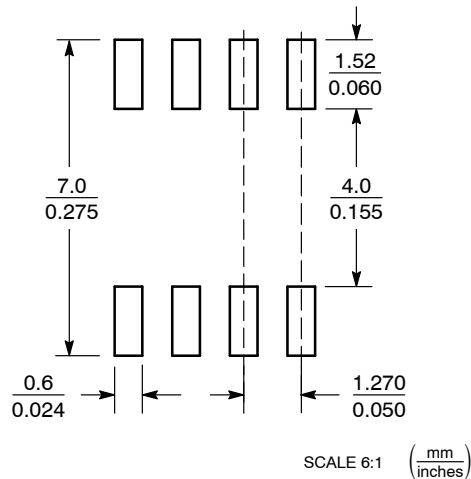

*For additional information on our Pb-Free strategy and soldering details, please download the ON Semiconductor Soldering and Mounting Techniques Reference Manual, SOLDERRM/D.

Micro8 is a trademark of International Rectifier.

ON Semiconductor and are registered trademarks of Semiconductor Components Industries, LLC (SCILLC). SCILLC owns the rights to a number of patents, trademarks, copyrights, trade secrets, and other intellectual property. A listing of SCILLC's product/patent coverage may be accessed at www.onsemi.com/site/pdf/Patent-Marking.pdf. SCILLC reserves the right to make changes without further notice to any products herein. SCILLC makes no warranty, representation or guarantee regarding the suitability of its products for any particular purpose, nor does SCILLC assume any liability arising out of the application or use of any product or circuit, and specifically disclaims any and all liability, including without limitation special, consequential or incidental damages. "Typical" parameters which may be provided in SCILLC data sheets and/or specifications can and do vary in different applications and actual performance may vary over time. All operating parameters, including "Typicals" must be validated for each customer application by customer's technical experts. SCILLC does not convey any license under its patent rights nor the rights of others. SCILLC products are not designed, intended, or authorized for use as components in systems intended for surgical implant into the body, or other applications intended to support or sustain life, or for any other application in which the failure of the SCILLC product could create a situation where personal injury or death may occur. Should Buyer purchase or use SCILLC products for any such unintended or unauthorized application, Buyer shall indemnify and hold SCILLC and its officers, employees, subsidiaries, affiliates, and distributors harmless against all claims, costs, damages, and expenses, and reasonable attorney fees arising out of, directly or indirectly, any claim of personal injury or death associated with such unintended or unauthorized use, even if such claim alleges that SCILLC was negligent regarding the design or manufacture of the part. SCILLC is an Equal Opportunity/Affirmative Action Employer. This literature is subject to all applicable copyright laws and is not for resale in any manner.

PUBLICATION ORDERING INFORMATION

LITERATURE FULFILLMENT:
Literature Distribution Center for ON Semiconductor
P.O. Box 5163, Denver, Colorado 80217 USA
Phone: 303-675-2175 or 800-344-3860 Toll Free USA/Canada
Fax: 303-675-2176 or 800-344-3867 Toll Free USA/Canada
Email: orderlit@onsemi.com

N. American Technical Support: 800-282-9855 Toll Free
USA/Canada
Europe, Middle East and Africa Technical Support:
Phone: 421 33 790 2910
Japan Customer Focus Center
Phone: 81-3-5817-1050

ON Semiconductor Website: www.onsemi.com
Order Literature: <http://www.onsemi.com/orderlit>

For additional information, please contact your local Sales Representative

Компания «Океан Электроники» предлагает заключение долгосрочных отношений при поставках импортных электронных компонентов на взаимовыгодных условиях!

Наши преимущества:

- Поставка оригинальных импортных электронных компонентов напрямую с производств Америки, Европы и Азии, а так же с крупнейших складов мира;
- Широкая линейка поставок активных и пассивных импортных электронных компонентов (более 30 млн. наименований);
- Поставка сложных, дефицитных, либо снятых с производства позиций;
- Оперативные сроки поставки под заказ (от 5 рабочих дней);
- Экспресс доставка в любую точку России;
- Помощь Конструкторского Отдела и консультации квалифицированных инженеров;
- Техническая поддержка проекта, помощь в подборе аналогов, поставка прототипов;
- Поставка электронных компонентов под контролем ВП;
- Система менеджмента качества сертифицирована по Международному стандарту ISO 9001;
- При необходимости вся продукция военного и аэрокосмического назначения проходит испытания и сертификацию в лаборатории (по согласованию с заказчиком);
- Поставка специализированных компонентов военного и аэрокосмического уровня качества (Xilinx, Altera, Analog Devices, Intersil, Interpoint, Microsemi, Actel, Aeroflex, Peregrine, VPT, Syfer, Eurofarad, Texas Instruments, MS Kennedy, Miteq, Cobham, E2V, MA-COM, Hittite, Mini-Circuits, General Dynamics и др.);

Компания «Океан Электроники» является официальным дистрибьютором и эксклюзивным представителем в России одного из крупнейших производителей разъемов военного и аэрокосмического назначения «JONHON», а так же официальным дистрибьютором и эксклюзивным представителем в России производителя высокотехнологичных и надежных решений для передачи СВЧ сигналов «FORSTAR».



JONHON

«JONHON» (основан в 1970 г.)

Разъемы специального, военного и аэрокосмического назначения:

(Применяются в военной, авиационной, аэрокосмической, морской, железнодорожной, горно- и нефтедобывающей отраслях промышленности)

«FORSTAR» (основан в 1998 г.)

ВЧ соединители, коаксиальные кабели, кабельные сборки и микроволновые компоненты:

(Применяются в телекоммуникациях гражданского и специального назначения, в средствах связи, РЛС, а так же военной, авиационной и аэрокосмической отраслях промышленности).



Телефон: 8 (812) 309-75-97 (многоканальный)

Факс: 8 (812) 320-03-32

Электронная почта: ocean@oceanchips.ru

Web: <http://oceanchips.ru/>

Адрес: 198099, г. Санкт-Петербург, ул. Калинина, д. 2, корп. 4, лит. А