

MAX5971B

Single-Port, 40W, IEEE 802.3af/at, PSE Controller with I²C

General Description

The MAX5971B is a single-port power controller designed for use in IEEE® 802.3af/at-compliant power-sourcing equipment (PSE). This device provides powered device (PD) discovery, classification, current limit, and DC and AC load-disconnect detections. The MAX5971B supports both fully automatic operation and software programmability, and features an integrated power MOSFET and sense resistor. The device supports detection and classification operation from a single 54V supply. In addition, it supports 2-event classification and new Class 5 classification of high-power PDs. The MAX5971B provides up to 40W to a single port (Class 5 enabled) and still provides high-capacitance detection for legacy PDs.

The device provides four operating modes to suit different system requirements. By default, auto mode allows the device to operate automatically at its default settings without any software. Semiautomatic mode automatically detects and classifies a device connected to the port after initial software activation, but does not power the port until instructed to by software. Manual mode allows total software control of the device and is useful for system diagnostics. Shutdown mode terminates all port activities and securely turns off power to the port.

The IC features an I²C-compatible, 2-wire serial interface, and is fully software-configurable and programmable. The device provides instantaneous readout of port current through the I²C interface. The device's extensive programmability enhances system flexibility, enables field diagnosis and allows for uses in other, non standard applications.

The device provides input undervoltage lockout (UVLO), input undervoltage detection, input overvoltage lockout, overtemperature protection, output voltage slew-rate limit during startup, and LED status indication. The MAX5971B programmability includes startup timeout, overcurrent timeout, and load-disconnect detection timeout.

The device is available in a space-saving, 28-pin TQFN (5mm x 5mm) power package and is rated for the extended (-40°C to +105°C) temperature range.

Applications

- Single-Port PSE End-Point Applications
- Single-Port PSE Power Injectors (Midspan Applications)
- Switches/Routers

IEEE is a registered service mark of the Institute of Electrical and Electronics Engineers, Inc.

Features

- ◆ IEEE 802.3af/at Compliant
- ◆ Up to 40W for Single-Port PSE Applications
- ◆ Integrated Power MOSFET and Sense Resistor
- ◆ Supports 54V Single-Supply Operation
- ◆ PD Detection and Classification
- ◆ I²C-Compatible, 2-Wire Serial Interface
- ◆ Instantaneous Readout of Port Current Through I²C Interface
- ◆ Programmable Current Limit for Class 5 PDs
- ◆ High-Capacitance Detection for Legacy Devices
- ◆ Supports Both DC and AC Load Removal Detections
- ◆ Current Foldback and Duty-Cycle-Controlled Current Limit
- ◆ LED Indicator for Port Status
- ◆ Direct Fast-Shutdown Control Capability
- ◆ Space-Saving, 28-Pin TQFN (5mm x 5mm) Power Package

Ordering Information

PART	TEMP RANGE	PIN-PACKAGE
MAX5971BETI+	-40°C to +105°C	28 TQFN-EP*

+Denotes a lead(Pb)-free/RoHS-compliant package.

*EP = Exposed pad.

Typical Operating Circuit

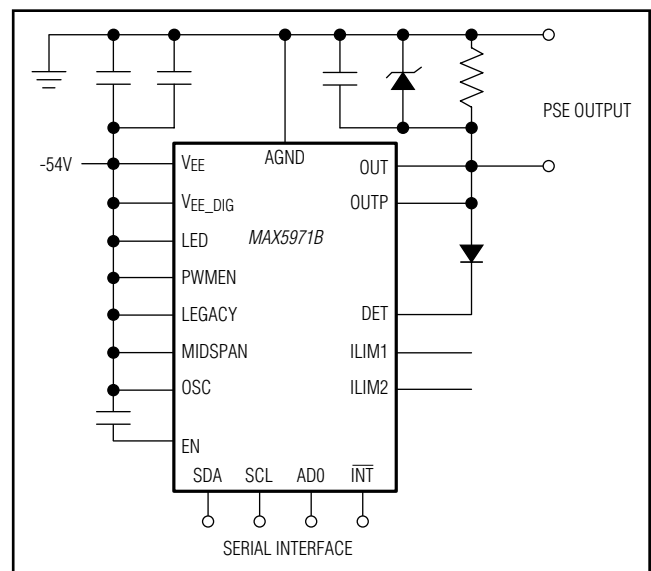

For pricing, delivery, and ordering information, please contact Maxim Direct at 1-888-629-4642, or visit Maxim's website at www.maximintegrated.com.

MAX5971B

Single-Port, 40W, IEEE 802.3af/at, PSE Controller with I2C

ABSOLUTE MAXIMUM RATINGS

(Voltages referenced to V_{EE}, unless otherwise noted.)

AGND, DET, LED	-0.3V to +80V
OUT	-0.3V to (V _{AGND} + 0.3V)
OUTP	-6V to (V _{AGND} + 0.3V)
VEE_DIG	-0.3V to +0.3V
OSC	-0.3V to +6V
EN, PWMEN, MIDSPAN, LEGACY, ILIM1, ILIM2	-0.3V to +4V
INT, AD0, SCL, SDA	-0.3V to +6V
Maximum Current into INT and SDA	80mA

Maximum Current into LED	40mA
Maximum Current into OUT	Internally Regulated
Continuous Power Dissipation (T _A = +70°C)	
28-Pin TQFN (derate 34.5mW/°C above +70°C)	2758mW
Operating Temperature Range	-40°C to +105°C
Storage Temperature Range	-65°C to +150°C
Junction Temperature	+150°C
Lead Temperature (soldering, 10s)	+300°C
Soldering Temperature (reflow)	+260°C

Stresses beyond those listed under "Absolute Maximum Ratings" may cause permanent damage to the device. These are stress ratings only, and functional operation of the device at these or any other conditions beyond those indicated in the operational sections of the specifications is not implied. Exposure to absolute maximum rating conditions for extended periods may affect device reliability.

PACKAGE THERMAL CHARACTERISTICS (Note 1)

28 TQFN

Junction-to-Ambient Thermal Resistance (θ _{JA})	29°C/W
Junction-to-Case Thermal Resistance (θ _{JC})	2°C/W

Note 1: Package thermal resistances were obtained using the method described in JEDEC specification JESD51-7, using a four-layer board. For detailed information on package thermal considerations, refer to www.maximintegrated.com/thermal-tutorial.

ELECTRICAL CHARACTERISTICS

(V_{AGND} - V_{EE} = 32V to 60V, T_A = -40°C to +105°C, all voltages are referenced to V_{EE}, unless otherwise noted. Typical values are at V_{AGND} - V_{EE} = +54V, T_A = +25°C. Currents are positive when entering the pin and negative otherwise.) (Note 2)

PARAMETER	SYMBOL	CONDITIONS	MIN	TYP	MAX	UNITS	
POWER SUPPLIES							
Operating Voltage Range	V _{AGND}	V _{AGND} - V _{EE}	32		60	V	
Supply Current	I _{EE}	V _{OUT} = V _{EE} , all logic inputs unconnected, measured at AGND in power mode		2.5	4	mA	
CURRENT LIMIT							
Current Limit	I _{LIM}	Maximum I _{LOAD} allowed during current-limit conditions, V _{OUT} = 0V (Note 3)	ICUT = 010	98	126	155	mA
			ICUT = 011	185	223	265	
			Class 0, 1, 2, 3 or ICUT = 000	400	420	441	
			Class 4 or ICUT = 001	684	720	756	
			Class 5 if ILIM1 = V _{EE} , ILIM2 = unconnected or ICUT = 101	807	850	893	
			Class 5 if ILIM1 = unconnected, ILIM2 = V _{EE} or ICUT = 110	855	900	945	
			Class 5 if ILIM1 = V _{EE} , ILIM2 = V _{EE} or ICUT = 111	902	950	998	
Foldback Initial OUT Voltage	V _{FLBK_ST}	V _{AGND} - V _{OUT} below which the current limit starts folding back		27		V	
Foldback Final OUT Voltage	V _{FLBK_END}	V _{AGND} - V _{OUT} below which the current limit reaches I _{TH_FB}		10		V	
Minimum Foldback Current-Limit Threshold	I _{TH_FB}	V _{OUT} = V _{AGND}		166		mA	

MAX5971B

Single-Port, 40W, IEEE 802.3af/at, PSE Controller with I2C

ELECTRICAL CHARACTERISTICS (continued)

(V_{AGND} - V_{EE} = 32V to 60V, T_A = -40°C to +105°C, all voltages are referenced to V_{EE}, unless otherwise noted. Typical values are at V_{AGND} - V_{EE} = +54V, T_A = +25°C. Currents are positive when entering the pin and negative otherwise.) (Note 2)

PARAMETER	SYMBOL	CONDITIONS		MIN	TYP	MAX	UNITS
OVERCURRENT							
Overcurrent Threshold	ICUT	Overcurrent threshold allowed for $t \leq t_{\text{FAULT}}$, V _{OUT} = 0V (Note 3)	ICUT = 010	86	111	136	mA
			ICUT = 011	162	196	233	
			Class 0, 1, 2, 3 or ICUT = 000	351	370	389	
			Class 4 or ICUT = 001	602	634	666	
			Class 5 if ILIM1 = V _{EE} , ILIM2 = unconnected or ICUT = 101	710	748	785	
			Class 5 if ILIM1 = unconnected, ILIM2 = V _{EE} or ICUT = 110	752	792	832	
Class 5 if ILIM1 = V _{EE} , ILIM2 = V _{EE} or ICUT = 111	794	836	878				
INTERNAL POWER							
DMOS On-Resistance		Measured from OUT to V _{EE} , I _{OUT} = 100mA	T _A = +25°C		0.5	0.9	Ω
			T _A = +105°C		0.6	1.3	
Power-Off OUT Leakage Current	I _{OUT_LEAK}	V _{EN} = V _{EE} , V _{OUT} = V _{AGND}				10	μA
SUPPLY MONITORS							
V _{EE} Undervoltage Lockout	V _{EE_UVLO}	V _{AGND} - V _{EE} , V _{AGND} increasing			28.5		V
V _{EE} Undervoltage Lockout Hysteresis	V _{EE_UVLOH}	Port is shutdown if: V _{AGND} - V _{EE} < V _{EE_UVLO} - V _{EE_UVLOH}			3		V
V _{EE} Overvoltage Lockout	V _{EE_OV}	V _{AGND} - V _{EE} > V _{EE_OV} , V _{AGND} increasing			62.5		V
V _{EE} Overvoltage Lockout Hysteresis	V _{EE_OVH}				1		V
V _{EE} Undervoltage	V _{EE_UV}	V _{EE_UV} event bit sets if: V _{AGND} - V _{EE} < V _{EE_UV} , V _{EE} increasing			40		V
Thermal Shutdown Threshold	T _{SHD}	Port is shut down and device resets if the junction temperature exceeds this limit, temperature increasing			+150		°C
Thermal Shutdown Hysteresis	T _{SHDH}	Temperature decreasing			20		°C
OUTPUT MONITOR							
OUT Input Current	I _{BOUT}	V _{OUT} = V _{AGND} , probing phases				6	μA
Idle Pullup Current at OUT	I _{DIS}	OUTP discharge current, detection and classification off, port shutdown, V _{OUTP} = V _{AGND} - 2.8V		200		265	μA
Short to V _{EE} Detection Threshold	DCN _{TH}	V _{OUT} - V _{EE} , V _{OUT} decreasing, enabled during detection		1.5	2.0	2.5	V
Short to V _{EE} Detection Threshold Hysteresis	DCN _{HY}				220		mV

MAX5971B

Single-Port, 40W, IEEE 802.3af/at, PSE Controller with I2C

ELECTRICAL CHARACTERISTICS (continued)

(V_{AGND} - V_{EE} = 32V to 60V, T_A = -40°C to +105°C, all voltages are referenced to V_{EE}, unless otherwise noted. Typical values are at V_{AGND} - V_{EE} = +54V, T_A = +25°C. Currents are positive when entering the pin and negative otherwise.) (Note 2)

PARAMETER	SYMBOL	CONDITIONS	MIN	TYP	MAX	UNITS	
LOAD DISCONNECT							
DC Load-Disconnect Threshold	I _{DC_TH}	Minimum load current allowed before disconnect (DC disconnect active), V _{OUT} = 0V	5	7.5	10	mA	
AC Load-Disconnect Threshold (Note 4)	I _{AC_TH}	Current into DET, for I _{DET} < I _{AC_TH} the port powers off (AC disconnect active)	115	130	145	μA	
Triangular Wave Peak-to-Peak Voltage Amplitude	AMPTRW	Measured at DET, referred to AGND	3.85	4	4.2	V	
OSC Pullup/Pulldown Currents	I _{OSC}	Measured at OSC	26	32	39	μA	
ACD_EN Threshold	V _{ACD_EN}	V _{OSC} - V _{EE} > V _{ACD_EN} to activate AC disconnect	270	330	380	mV	
Load-Disconnect Timer	t _{DISC}	Time from I _{RSENSE} < I _{DC_TH} (DC disconnect active) or I _{DET} < I _{AC_TH} (AC disconnect active) to gate shutdown (Note 5)	300		400	ms	
DETECTION							
Detection Probe Voltage (First Phase)	V _{DPH1}	V _{AGND} - V _{DET} during the first detection phase	3.8	4	4.2	V	
Detection Probe Voltage (Second Phase)	V _{DPH2}	V _{AGND} - V _{DET} during the second detection phase	9	9.3	9.6	V	
Current-Limit Protection	I _{DLIM}	V _{DET} = V _{AGND} during detection, measure current through DET	1.50	1.75	2.00	mA	
Short-Circuit Threshold	V _{DCP}	If V _{AGND} - V _{OUT} < V _{DCP} after the first detection phase a short circuit to AGND is detected.		1		V	
Open-Circuit Threshold	I _{D_OPEN}	First point measurement current threshold for open condition		20		μA	
Resistor Detection Window	R _{DOK}	(Note 6)	19		26.5	kΩ	
Resistor Rejection Window	R _{DBAD}	Detection rejects lower values			15.5	kΩ	
		Detection rejects higher values	32				
CLASSIFICATION							
Classification Probe Voltage	V _{CL}	V _{AGND} - V _{DET} during classification	16		20	V	
Current-Limit Protection	I _{CILIM}	V _{DET} = V _{AGND} , during classification measure current through DET	65		80	mA	
Classification Current Thresholds	I _{CL}	Classification current thresholds between classes	Class 0, Class 1	5.5	6.5	7.5	mA
			Class 1, Class 2	13.0	14.5	16.0	
			Class 2, Class 3	21	23	25	
			Class 3, Class 4	31	33	35	
			Class 4 upper limit (Note 7)	45	48	51	

MAX5971B

Single-Port, 40W, IEEE 802.3af/at, PSE Controller with I2C

ELECTRICAL CHARACTERISTICS (continued)

(V_{AGND} - V_{EE} = 32V to 60V, T_A = -40°C to +105°C, all voltages are referenced to V_{EE}, unless otherwise noted. Typical values are at V_{AGND} - V_{EE} = +54V, T_A = +25°C. Currents are positive when entering the pin and negative otherwise.) (Note 2)

PARAMETER	SYMBOL		MIN	TYP	MAX	UNITS
Mark Event Voltage	V _{MARK}	V _{AGND} - V _{DET} during mark event	8		10	V
Mark Event Current Limit	I _{MARK_LIM}	V _{DET} = V _{AGND} during mark event measure current through DET	55		80	mA
DIGITAL INPUTS/OUTPUTS (Voltages Referenced to V_{EE})						
Digital Input Low	V _{IL}				0.8	V
Digital Input High	V _{IH}		2.4			V
Internal Input Pullup Current	I _{PU}	Pullup current to internal digital supply to set default values	3	5	7	μA
Open-Drain Output Low Voltage	V _{OL}	I _{SINK} = 10mA			0.4	V
Open-Drain Leakage	I _{OL}	Open-drain high impedance			2	μA
LED Output Low Voltage	V _{LED_LOW}	I _{LED} = 10mA, PWM disabled, port power-on			0.8	V
LED Output Leakage	I _{LED_LEAK}	PWM disabled, shutdown mode, V _{LED} = 60V			10	μA
PWM Frequency				25		kHz
PWM Duty Cycle				6.25		%
TIMING						
Startup Time	t _{START}	Time during which a current limit set to 420mA is allowed, starts when power is turned on (Note 8)	50	60	70	ms
Fault Time	t _{FAULT}	Maximum allowed time for an overcurrent condition set by I _{CUT} after startup (Note 8)	50	60	70	ms
Detection Reset Time	t _{ME}	Time allowed for the port voltage to reset before detection starts		80	90	ms
Detection Time	t _{DET}	Maximum time allowed before detection is completed			330	ms
Midspan Mode Detection Delay	t _{DMID}		2	2.2	2.4	s
Classification Time	t _{CLASS}	Time allowed for classification		19	23	ms
Mark Event Time		Time allowed for mark event	7	9	11	ms
V _{EE_UVLO} Turn-On Delay	t _{DLY}	Time V _{AGND} must be above the V _{EE_UVLO} thresholds before the device operates		5.2		ms
Restart Timer	t _{RESTART}	Time the device waits before turning on after an overcurrent fault (Note 8)		16 x t _{FAULT}		ms
Watchdog Clock Period		Rate of decrement of the watchdog time		164		ms
ADC PERFORMANCE (Power-On Mode)						
Resolution				9		Bits
Range				1		A
LSB Step Size				1.95		mA
Gain Error		T _A = +25°C			2	%
		T _A = -40°C to +105°C		3		

MAX5971B

Single-Port, 40W, IEEE 802.3af/at, PSE Controller with I2C

ELECTRICAL CHARACTERISTICS (continued)

(V_{AGND} - V_{EE} = 32V to 60V, T_A = -40°C to +105°C, all voltages are referenced to V_{EE}, unless otherwise noted. Typical values are at V_{AGND} - V_{EE} = +54V, T_A = +25°C. Currents are positive when entering the pin and negative otherwise.) (Note 2)

PARAMETER	SYMBOL	CONDITIONS	MIN	TYP	MAX	UNITS
ADC Absolute Accuracy		I _{OUT} = 400mA, T _A = +25°C	201	205	209	LSB
		I _{OUT} = 400mA, T _A = -40°C to +105°C		205		
Integral Nonlinearity	INL	T _A = +25°C		0.3	1.5	LSB
		T _A = -40°C to +105°C		0.3		
Differential Nonlinearity	DNL	T _A = +25°C		0.3	1.5	LSB
		T _A = -40°C to +105°C		0.3		
TIMING CHARACTERISTICS (For 2-Wire Fast Mode)						
Serial Clock Frequency	f _{SCL}		100		400	kHz
Bus Free Time Between a STOP and START Condition	t _{BUF}		1.3			μs
Hold Time for a START Condition	t _{HD,STA}		0.6			μs
Low Period of the SCL Clock	t _{LOW}		1.3			μs
High Period of the SCL Clock	t _{HIGH}		0.6			μs
Setup Time for a Repeated START Condition	t _{SU,STA}		0.6			μs
Data Hold Time	t _{HD,DAT}		0		150	ns
Data in Setup Time	t _{SU,DAT}		100			ns
Rise Time of Both SDA and SCL Signals, Receiving	t _R	(Note 9)	20 + 0.1C _B		300	ns
Fall Time of SDA Transmitting	t _F	(Note 9)			250	ns
Setup Time for STOP Condition	t _{SU,STO}		0.6			μs
Capacitive Load for Each Bus Line	C _B	(Note 9)			400	pF
Pulse Width of Spike Suppressed	t _{SP}	(Note 9)		50		ns

Note 2: This device is production tested at T_A = +25°C. Limits to T_A = -40°C to +105°C are guaranteed by design.

Note 3: Default thresholds are set by the classification result in auto mode. The thresholds are manually software programmable through the ICUT Register (R2Ah[2:0]). If ILIM1 and ILIM2 are both unconnected, Class 5 detection is disabled. See the *Class 5 PD Classification* section and Table 3 for details and settings.

Note 4: Default value. The AC load-disconnect threshold can be programmed through the AC_TH register (R23h[2:0]).

Note 5: Default value. The load-disconnect time, t_{DISC} can be programmed through the TDISC register (R16h[1:0]).

Note 6: R_{DOK} = (V_{OUT2} - V_{OUT1})/(I_{DET2} - I_{DET1}). V_{OUT1}, V_{OUT2}, I_{DET2}, and I_{DET1} represent the voltage at OUT and the current at DET during phase 1 and 2 of the detection, respectively.

Note 7: If Class 5 is enabled, this value is the classification current threshold from Class 4 to Class 5.

Note 8: Default values. The startup, fault, and restart timers can be programmed through the TSTART (R16h[5:4]), TFAULT (R16h[3:2]), and RSRT (R16h[7:6]) registers, respectively.

Note 9: Guaranteed by design. Not subject to production testing.

MAX5971B

Single-Port, 40W, IEEE 802.3af/at, PSE Controller with I2C

Typical Operating Characteristics

($V_{AGND} = 54V$, $V_{EE} = V_{EE_DIG} = 0V$, $T_A = +25^\circ C$, endpoint mode and default register settings with a Class 0 PD, unless otherwise otherwise noted.)

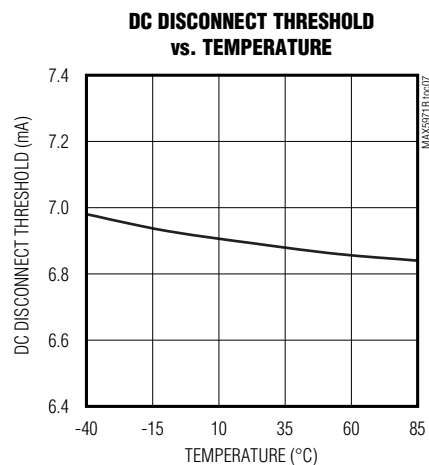
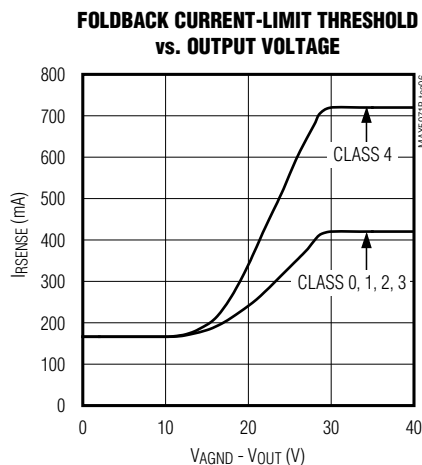
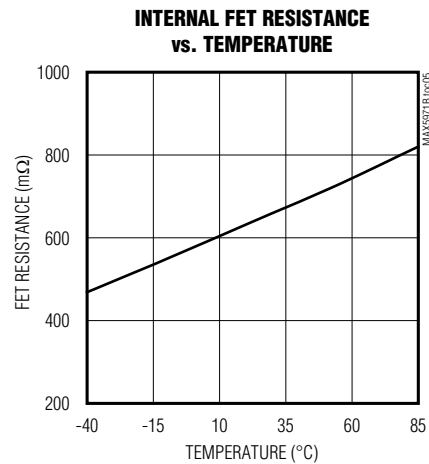
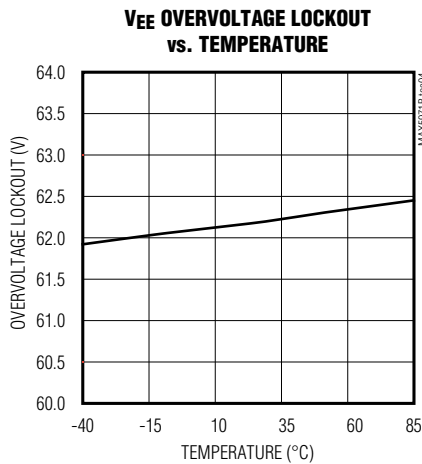
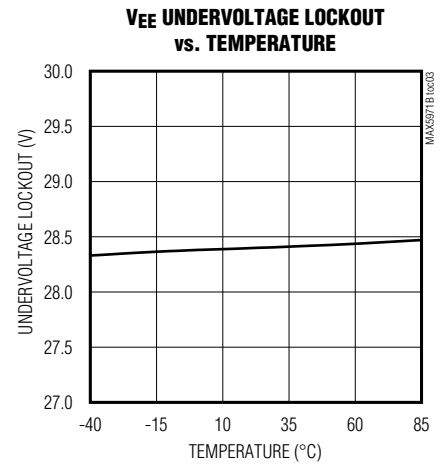
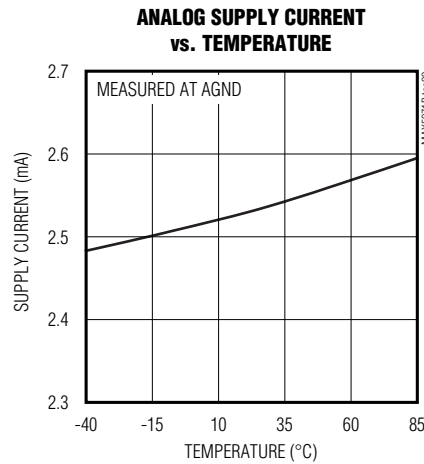
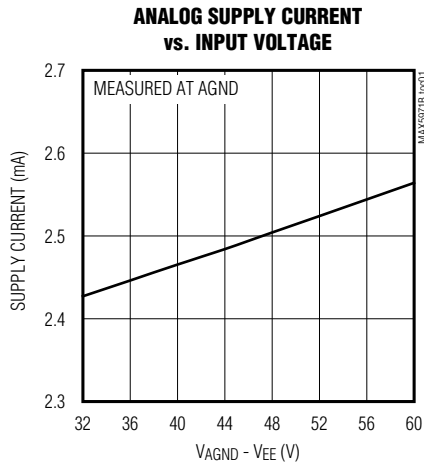

MAX5971B

Single-Port, 40W, IEEE 802.3af/at, PSE Controller with I2C

Typical Operating Characteristics (continued)

($V_{AGND} = 54V$, $V_{EE} = V_{EE_DIG} = 0V$, $T_A = +25^\circ C$, endpoint mode and default register settings with a Class 0 PD, unless otherwise otherwise noted.)

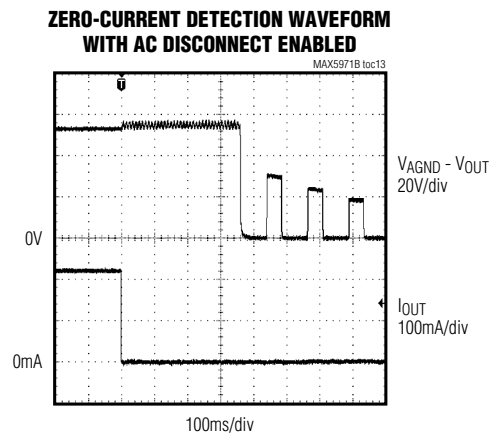
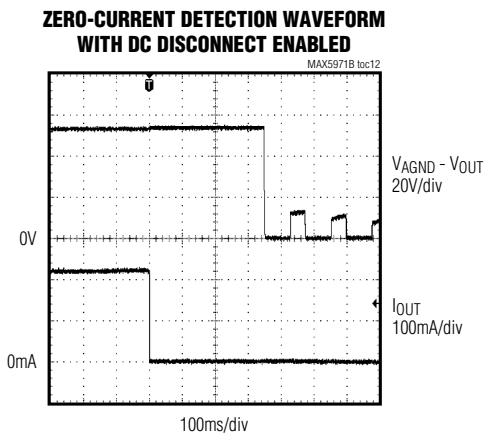
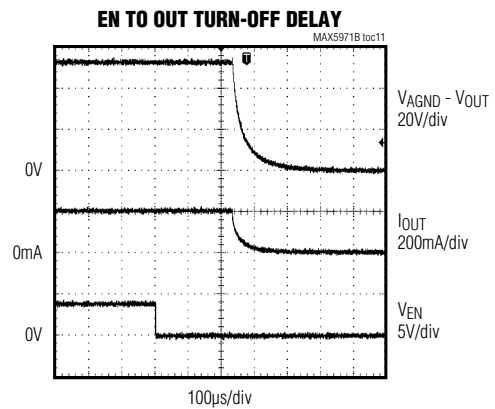
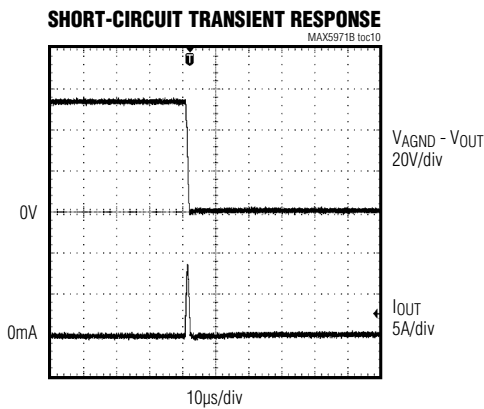
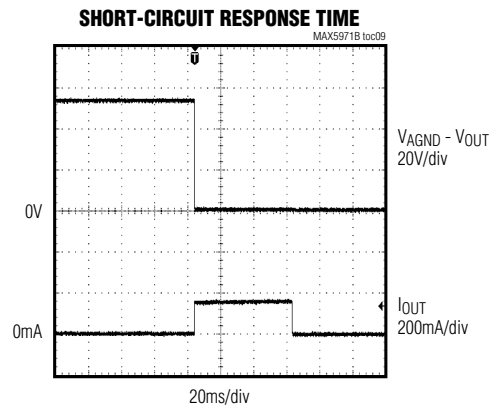
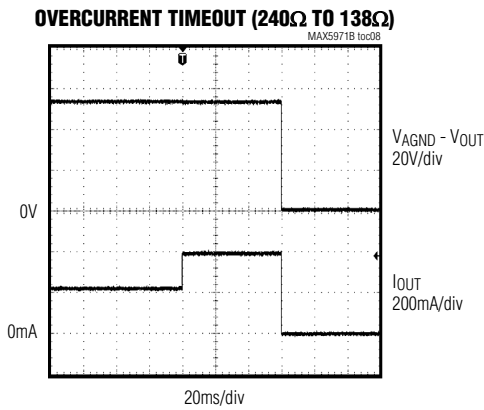

MAX5971B

Single-Port, 40W, IEEE 802.3af/at, PSE Controller with I2C

Typical Operating Characteristics (continued)

($V_{AGND} = 54V$, $V_{EE} = V_{EE_DIG} = 0V$, $T_A = +25^\circ C$, endpoint mode and default register settings with a Class 0 PD, unless otherwise otherwise noted.)

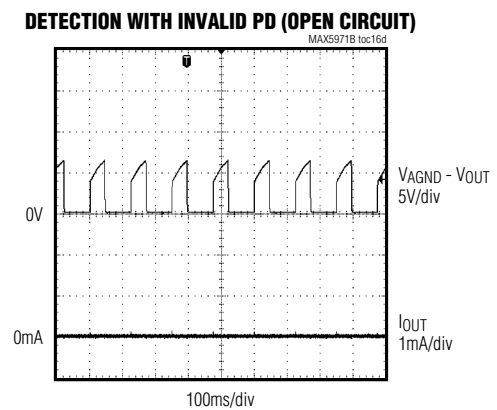
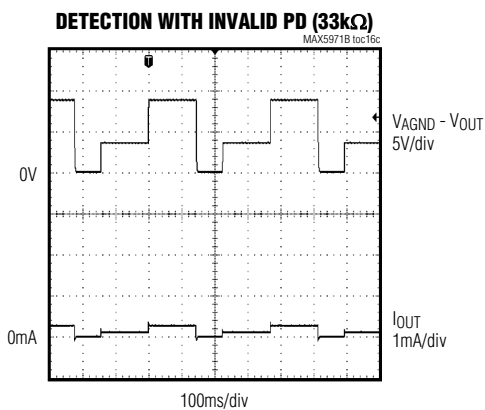
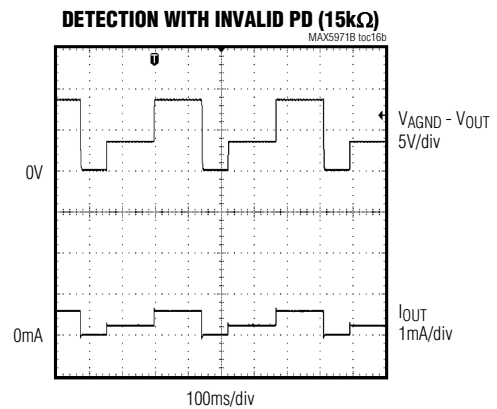
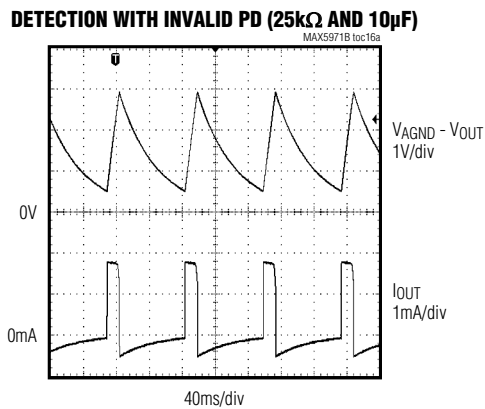
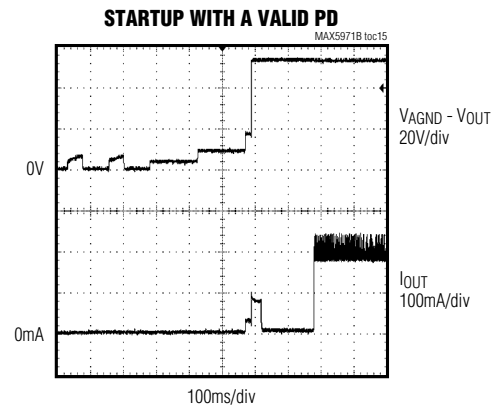
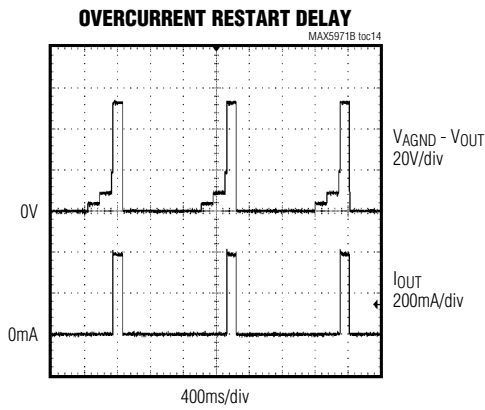

MAX5971B

Single-Port, 40W, IEEE 802.3af/at, PSE Controller with I2C

Typical Operating Characteristics (continued)

($V_{AGND} = 54V$, $V_{EE} = V_{EE_DIG} = 0V$, $T_A = +25^\circ C$, endpoint mode and default register settings with a Class 0 PD, unless otherwise otherwise noted.)

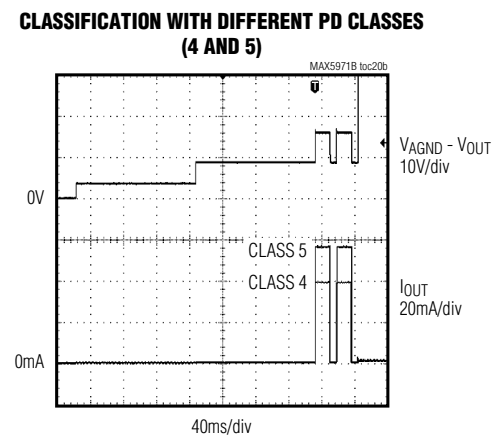
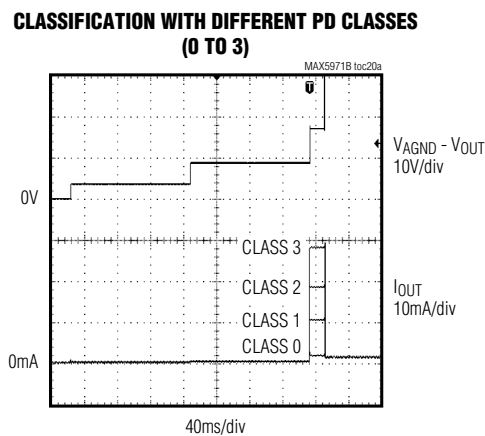
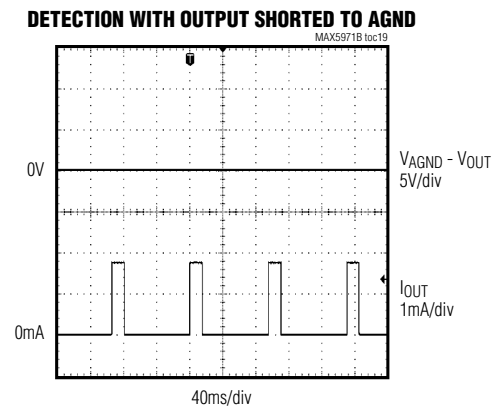
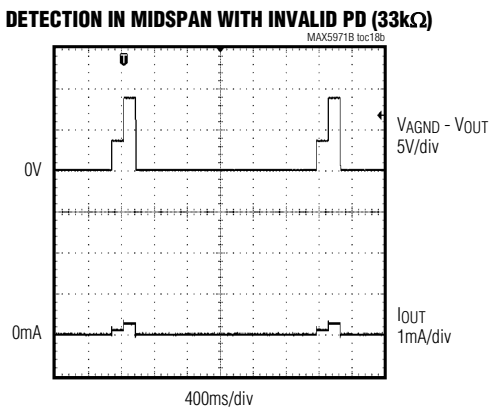
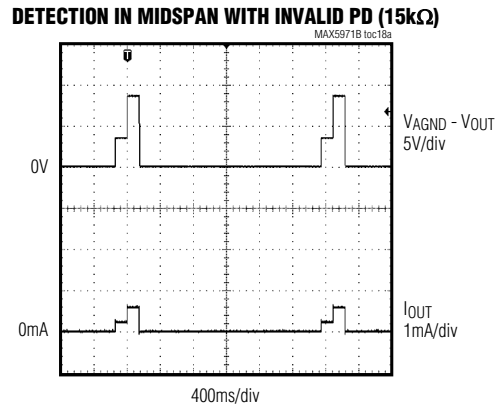
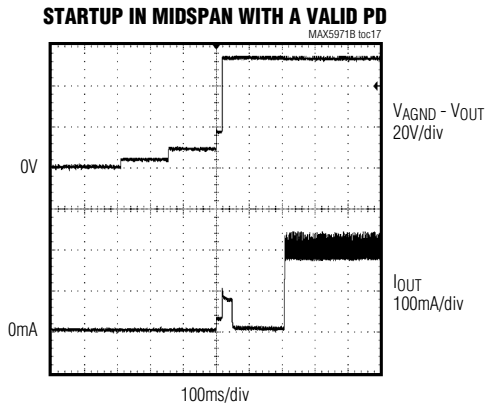

MAX5971B

Single-Port, 40W, IEEE 802.3af/at, PSE Controller with I2C

Typical Operating Characteristics (continued)

($V_{AGND} = 54V$, $V_{EE} = V_{EE_DIG} = 0V$, $T_A = +25^\circ C$, endpoint mode and default register settings with a Class 0 PD, unless otherwise otherwise noted.)

STARTUP USING 2-EVENT CLASSIFICATION WITH A VALID PD (CLASS 4)

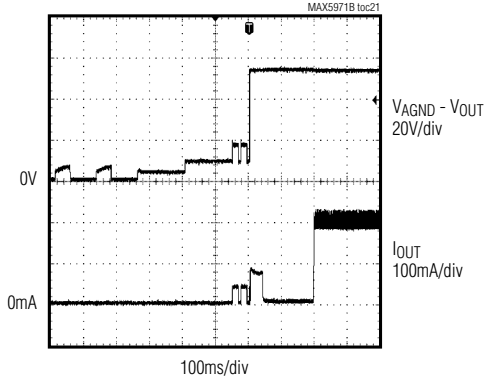

LED DETECTION FAULT WITH PWM ENABLED

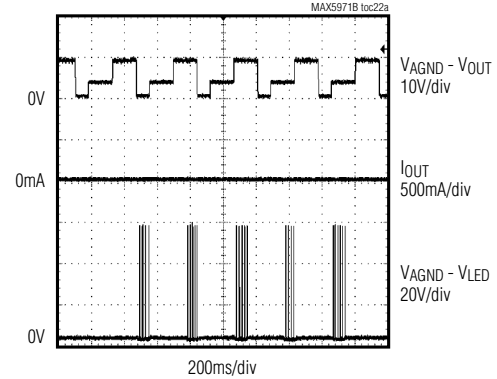

LED DETECTION FAULT WITH PWM DISABLED

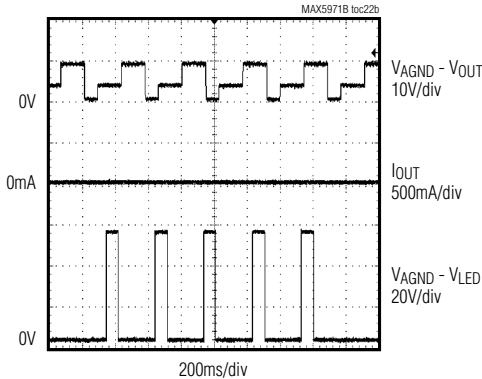

LED OVERCURRENT FAULT WITH PWM ENABLED

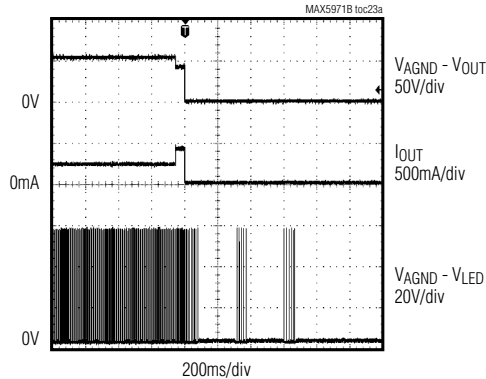

LED OVERCURRENT FAULT WITH PWM DISABLED

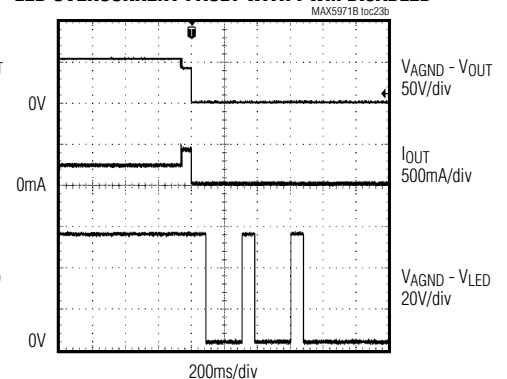

LED PWM TIMING: MINIMUM DUTY CYCLE (DEFAULT)

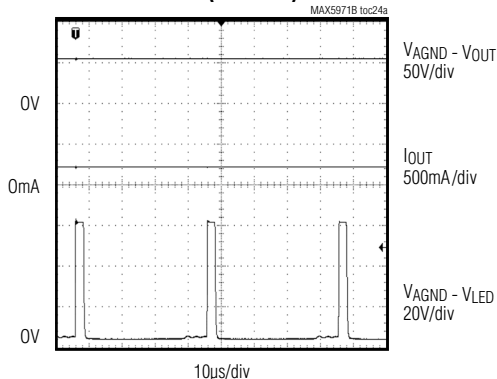

LED PWM TIMING: MAXIMUM DUTY CYCLE (PROGRAMMABLE)

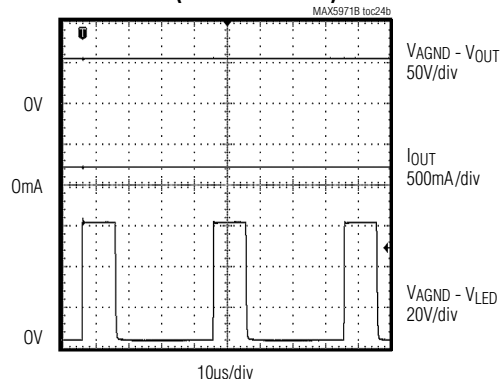

MAX5971B

Single-Port, 40W, IEEE 802.3af/at, PSE Controller with I2C

Pin Configuration

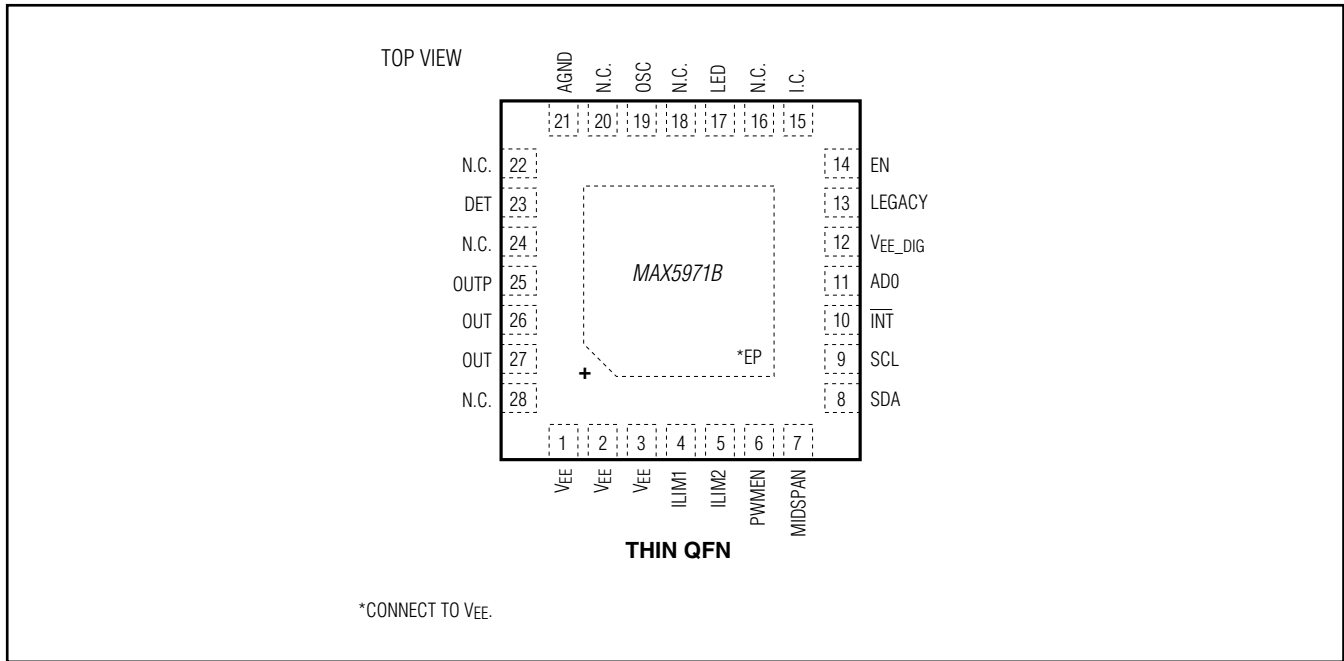

Pin Description

PIN	NAME	FUNCTION
1, 2, 3	VEE	Analog Low-Side Supply Input. Bypass with an external 100V, 47 μ F capacitor in parallel with a 100V, 0.1 μ F ceramic capacitor between AGND and VEE.
4	ILIM1	Class 5 Current-Limit Digital Adjust 1. Referenced to VEE. ILIM1 is internally pulled up to the digital supply. Use ILIM1 with ILIM2 to enable Class 5 operation and to adjust the Class 5 current-limit value. See the <i>Electrical Characteristics</i> table and Table 3 in the <i>Class 5 PD Classification</i> section for details.
5	ILIM2	Class 5 Current-Limit Digital Adjust 2. Referenced to VEE. ILIM2 is internally pulled up to the digital supply. Use ILIM2 with ILIM1 to enable Class 5 operation and to adjust the Class 5 current-limit value. See the <i>Electrical Characteristics</i> table and Table 3 in the <i>Class 5 PD Classification</i> section for details.
6	PWMEN	PWM Control Logic Input. Referenced to VEE. PWMEN is internally pulled up to the digital supply. Leave unconnected to enable the internal PWM to drive the LED pin. Force low to disable the internal PWM.
7	MIDSPAN	Detection Collision Avoidance Logic Input. Referenced to VEE. MIDSPAN is internally pulled up to the digital supply. Leave unconnected to activate the detection collision avoidance circuitry for midspan PSE systems. Force low to disable this function for an end-point PSE system. The MIDSPAN logic level latches after the device is powered up or after a reset condition.
8	SDA	2-Wire Serial Interface Input/Output Data Line. Referenced to VEE. Connect to VEE if the I ² C interface is not used.

MAX5971B

Single-Port, 40W, IEEE 802.3af/at, PSE Controller with I²C

Pin Description (continued)

PIN	NAME	FUNCTION
9	SCL	2-Wire Serial Interface Input Clock Line. Referenced to V _{EE} . Connect to V _{EE} if the I ² C interface is not used.
10	$\overline{\text{INT}}$	Open-Drain Interrupt Output. Referenced to V _{EE} . $\overline{\text{INT}}$ is pulled low whenever an interrupt is sent to the microcontroller. See the <i>Interrupt</i> section for details. Connect to V _{EE} if the I ² C interface is not used.
11	AD0	Address Input. Referenced to V _{EE} . AD0 is used to form the lower part of the device address. See the <i>Device Address (AD0)</i> section and Table 5 for details. Connect to V _{EE} if the I ² C interface is not used.
12	V _{EE} _DIG	Digital Low-Side Supply Input. Connect to V _{EE} externally.
13	LEGACY	Legacy Detection Logic Input. Referenced to V _{EE} . LEGACY is internally pulled up to the digital supply. Leave unconnected to activate the legacy PD detection. Force low to disable this function. The LEGACY logic level latches after the device is powered up or after a reset condition.
14	EN	Enable Input. Referenced to V _{EE} . EN is internally pulled up to the digital supply. Leave unconnected to enable the device. Force low for at least 40 μ s to reset the device. The MIDSPAN, OSC, and LEGACY states latch-in when the reset condition is removed (low-to-high transition). Bypass EN to V _{EE} with a 1nF ceramic capacitor.
15	I.C.	Internally Connected. Connect I.C. to V _{EE} .
16, 18, 20, 22, 24, 28	N.C.	No Connection. Not internally connected. Leave N.C. unconnected.
17	LED	LED Indicator Open-Drain Output. Referenced to V _{EE} . LED can sink 10mA and can drive an external LED directly. Blinking functionality is provided to signal different conditions (see the <i>PWM and LED Signals</i> section). Connect LED to AGND externally (see Figures 15 and 16) or to an external supply (if available) through a series resistance.
19	OSC	AC-Disconnect Triangular Wave Output. Bypass with a 100nF (\pm 10% tolerance) external capacitor to V _{EE} to enable the AC disconnect function. Connect OSC to V _{EE} to disable the AC disconnect function and to activate the DC disconnect function. The OSC state latches after the device is powered up or after a reset condition.
21	AGND	High-Side Supply Input
23	DET	Detection/Classification Voltage Output. DET is used to set the detection and classification probe voltages and for the AC current sensing when using the AC disconnect function. To use the AC disconnect function, place a 1k Ω and 0.47 μ F RC series in parallel with the external protection diode to OOTP (see Figure 16).
25	OOTP	Port Pullup Output. OOTP is used to pull up the port voltage to AGND when needed. If AC disconnect is used, connect OOTP to the anode of the AC-blocking diode. If AC disconnect is not used, connect OOTP to OUT (see Figures 15 and 17). Bypass OOTP to AGND with a 100V, 0.1 μ F ceramic capacitor.
26, 27	OUT	Integrated MOSFET Output. If DC disconnect is used, connect the port output to OOTP (see Figures 15 and 17). If the AC disconnect function is used, connect OUT to the cathode of the AC-blocking diode (see Figure 16).
—	EP	Exposed Pad. Connect EP to V _{EE} externally. See the <i>Layout Procedure</i> section for details.

MAX5971B

Single-Port, 40W, IEEE 802.3af/at, PSE Controller with I2C

Simplified Diagram

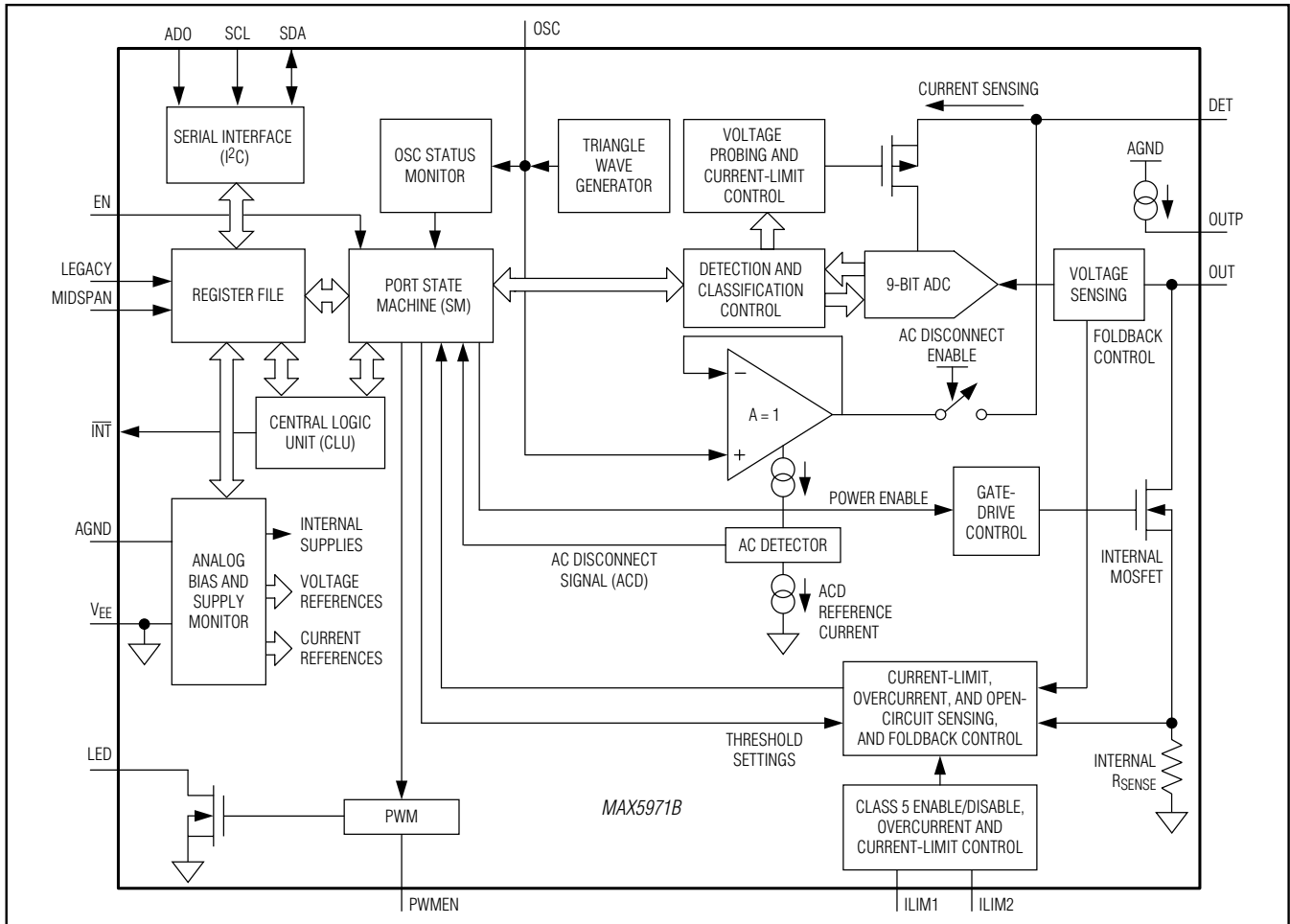

Detailed Description

The MAX5971B is a single-port power controller designed for use in IEEE 802.3af/802.3at-compliant PSE. This device provides PD discovery, classification, current limit, and DC and AC load-disconnect detections. The MAX5971B supports both fully automatic operation and software programmability, and features an integrated power MOSFET and sense resistor. The device also supports new Class 5 and 2-event classification for detection and classification of high-power PDs. The MAX5971B provides up to 40W to a single port (Class 5 enabled), and still provides high-capacitance detection for legacy PDs.

The MAX5971B features an I²C-compatible, 2-wire serial interface, and is fully software configurable and programmable. The device provides instantaneous readout

of port current through the I²C interface. The MAX5971B provides input undervoltage lockout (UVLO), input undervoltage detection, input overvoltage lockout, overtemperature protection, output voltage slew-rate limit during startup, and LED status indication. The MAX5971B programmability includes startup timeout, overcurrent timeout, and load-disconnect detection timeout.

Reset

The MAX5971B is reset by any of the following conditions:

- 1) Power-Up. Reset condition is cleared once V_{EE} rises above the UVLO threshold.
- 2) Hardware Reset. Reset occurs once the EN input is driven low (> 40μs, typ) any time after power-up. The device exits the reset condition once the EN input is driven high again.

MAX5971B

Single-Port, 40W, IEEE 802.3af/at, PSE Controller with I2C

- 3) Software Reset. To initiate a software reset, write a logical 1 to the RESET_IC register (R1Ah[4]) any time after power-up. Reset clears automatically and all registers are set to their default states.
- 4) Thermal Shutdown. The device enters thermal shutdown at 150°C. The device exits thermal shutdown and is reset once the temperature drops below 130°C.

At the end of a reset event, the MAX5971B latches in the state of MIDSPAN, LEGACY, and OSC. During normal operation, changes to the MIDSPAN and LEGACY inputs are ignored, and these inputs can be changed at any time prior to the end of a reset state. Changes to OSC input during normal operation can impact device functionality. Therefore, OSC is only changed while the device is held in a reset state (or powered down), and OSC then latches in when the reset state ends (other schematic modifications may be needed, see Figures 15 and 16).

Port Reset

Set RESET_P (R1Ah[0]) high anytime during normal operation to turn off port power and clear the port event and status registers. Port reset does not initiate a global device reset.

Midspan Mode

In midspan mode, the device adopts cadence timing during the detection phase. When cadence timing is enabled and a failed detection occurs, the port waits between 2s and 2.4s before attempting to detect again. Midspan mode is activated by setting MIDSPAN high and then powering or resetting the device. Alternatively, midspan mode is software enabled by setting BCKOFF (R15h[0], Table 23) to a logical 1. By default, the MIDSPAN input is internally pulled high, enabling cadence timing. Force MIDSPAN low to disable this function.

Operation Modes

The MAX5971B provides four operating modes to suit different system requirements. By default, auto mode allows the device to operate automatically at its default settings without any software. Semiautomatic mode automatically detects and classifies a device connected to the port after initial software activation, but does not power up the port until instructed to by software. Manual mode allows total software control of the device and is useful for system diagnostics. Shutdown mode terminates all activities and securely turns off power to the port.

Switching between auto, semiautomatic, and manual mode does not interfere with the operation of the output port. When the port is set into shutdown mode, all

port operations are immediately stopped and the port remains idle until shutdown mode is exited.

Auto (Automatic) Mode

By default, the MAX5971B enters auto mode after the reset condition is cleared. To manually place the MAX5971B into auto mode from any other mode, set P_M[1:0] (R12h[1:0]) to [11] during normal operation (see Tables 19 and 20).

In auto mode, the MAX5971B performs detection and classification, and powers up the port automatically if a valid PD is connected to the port. If a valid PD is not connected at the port, the MAX5971B repeats the detection routine continuously until a valid PD is connected.

When entering auto mode, the DET_EN and CLASS_EN bits (R14h[0] and R14h[4], Table 22) are set to high and stay high unless changed by software. Using software to set DET_EN and/or CLASS_EN low causes the MAX5971B to skip detection and/or classification. As a protection, disabling the detection routine in auto mode does not allow the corresponding port to power up, unless the DET_BY bit (R23h[4], Table 33) is set to 1.

Semiautomatic (Semi) Mode

The MAX5971B is put into semiautomatic mode by setting P_M[1:0] (R12h[1:0]) to [10] during normal operation (see Tables 19 and 20). In semi mode, the MAX5971B, upon request, performs detection and/or classification repeatedly but does not power up the port. To power the port, set the PWR_ON bit (R19h[0], Table 27) to 1. This immediately terminates the detection/classification routine and turns on power to the port.

DET_EN and CLASS_EN (R14h[0] and R14h[4], Table 22) default to low in semiautomatic mode. Use software to set DET_EN (R14h[0]) to 1 to start the detection routine and CLASS_EN (R14h[4]) to 1 to enable classification routine. They are reset every time the software commands a power-off of the port, either through a reset event or by writing a 1 to the PWR_OFF bit (R19h[4]). In any other case, the status of the bits is left unchanged (including when the state machine turns off the power when a load disconnect or a fault condition is encountered).

Manual Mode

The MAX5971B is placed in manual mode by setting P_M[1:0] (R12h[1:0]) to [01] during normal operation (see Tables 19 and 20). Manual mode allows the software to dictate the sequence of operation. Write a 1 to both R14h[0] (DET_EN) and R14h[4] (CLASS_EN) to start detection and classification operations, respectively, and in that priority order. In manual mode, after

MAX5971B

Single-Port, 40W, IEEE 802.3af/at, PSE Controller with I2C

execution, the command is cleared from the register(s). PWR_ON has highest priority. Setting PWR_ON to 1 at any time causes the device to immediately enter the powered mode. Setting DET_EN and CLASS_EN to 1 at the same time causes detection to be performed first. Once in the powered state, the device ignores DET_EN or CLASS_EN commands.

When switching to manual mode from another mode, DET_EN and CLASS_EN default to low. These bits become pushbutton rather than configuration bits. Writing 1 to these bits while in manual mode commands the device to execute one cycle of detection and/or classification. They are reset back to 0 at the end of the execution.

Shutdown Mode

To put the MAX5971B into shutdown mode, set P_M[1:0] (R12h[1:0]) to [00] during normal operation (see Table 19 and Table 20). Putting the MAX5971B into shutdown mode immediately turns off port power, clears the event and status bits, and halts all port operations. In shutdown mode the serial interface is still fully active, however, all DET_EN, CLASS_EN, and PWR_ON commands are ignored.

PD Detection

During normal operation, the MAX5971B probes the output for a valid PD. A valid PD has a 25k Ω discovery signature characteristic as specified in the IEEE 802.3af/802.3at standard. Table 1 shows the IEEE 802.3at specification for a PSE detecting a valid PD signature.

After each detection cycle, the MAX5971B sets DET_END (R04h[0] and R05h[0]) to 1 and reports the detection results in the detection status bits, DET_ST[2:0]

(R0Ch[2:0], see Table 14). The DET_END registers are reset to 0 when read through the CoR (clear-on-read) register R05h[0], or after a reset event.

During detection, the MAX5971B keeps the internal MOSFET off and forces two probe voltages through DET. The current through DET is measured as well as the voltage at OUT. A two-point slope measurement is used, as specified by the IEEE 802.3af/802.3at standard, to verify the device connected to the port. By default, The MAX5971B load stability check is disabled. Set LSC_EN (R29h[4], Table 36) to 1 to enable the load stability check. The MAX5971B implements appropriate settling times to reject 50Hz/60Hz power-line noise coupling.

An external diode, in series with the DET input, restricts PD detection to the first quadrant as specified by the IEEE 802.3af/802.3at standard. To prevent damage to non-PD devices, and to protect itself from an output short circuit, the MAX5971B limits the current into DET to less than 2mA (max) during PD detection.

In midspan mode, after every failed detection cycle, the MAX5971B waits at least 2.0s before attempting another detection cycle. The first detection, however, still happens immediately after exiting a reset condition.

High-Capacitance Detection

High-capacitance detection for legacy PDs is both software and pin programmable (LEGACY). To use software to enable high-capacitance detection, set CLC_EN (R23h[5]) to 1 during normal operation. Alternatively, the status of the LEGACY input is latched and written to CLC_EN during power-up or after reset condition is cleared. The LEGACY input is internally pulled

Table 1. PSE PI Detection Modes Electrical Requirements (IEEE 802.3at)

PARAMETER	SYMBOL	MIN	MAX	UNITS	ADDITIONAL INFORMATION
Open-Circuit Voltage	VOC		30	V	In detection mode only
Short-Circuit Current	ISC		5	mA	In detection mode only
Valid Test Voltage	VVALID	2.8	10	V	
Voltage Difference Between Test Points	Δ VTEST	1		V	
Time Between Any Two Test Points	tBP	2		ms	This timing implies a 500Hz maximum probing frequency
Slew Rate	VSLEW		0.1	V/ μ s	
Accept Signature Resistance	RGOOD	19	26.5	k Ω	
Reject Signature Resistance	RBAD	< 15	> 33	k Ω	
Open-Circuit Resistance	ROPEN	500		k Ω	
Accept Signature Capacitance	CGOOD		150	nF	
Reject Signature Capacitance	CBAD	10		μ F	
Signature Offset Voltage Tolerance	VOS	0	2.0	V	
Signature Offset Current Tolerance	IOS	0	12	μ A	

MAX5971B

Single-Port, 40W, IEEE 802.3af/at, PSE Controller with I2C

high, enabling high-capacitance detection. Unless high-capacitance detection is needed, connect LEGACY to VEE to disable this function. If high-capacitance detection is enabled, PD signature capacitances up to 47µF (typ) are accepted.

Powered Device Classification (PD Classification)

During PD classification, the MAX5971B forces a probe voltage (-18V, typ) at DET and measures the current into DET. The measured current determines the class of the PD.

After each classification cycle, the MAX5971B sets CL_END (R04h[4] and R05h[4]) to 1 and reports the classification results in the classification status bits, CLASS[2:0] (R0Ch[6:4], see Table 14). The CL_END "registers are reset to 0 when read through the CoR (clear- on-read) register, R05h, or after a reset event.

If ILIM1 and ILIM2 are both left unconnected, the MAX5971B classifies the PD based on Table 33.9 of the IEEE 802.3at standard (see Table 2). If the measured

current exceeds 51mA, the MAX5971B does not power the PD, but returns to idle state before attempting a new detection cycle.

Class 5 PD Classification

The MAX5971B supports high power beyond the IEEE 802.3at standard by providing an additional classification (Class 5) if needed. To enable Class 5 detection and select the corresponding current-limit/overcurrent thresholds, ILIM1 and ILIM2 must be set based on the combinations detailed in Table 3. Once Class 5 is enabled, during classification, if the MAX5971B detects currents in excess of the Class 4 upper limit threshold, the PD is classified as a Class 5 powered device. The PD is guaranteed to be classified as a Class 5 device for any classification current from 51mA up to the classification current-limit threshold.

The Class 5 overcurrent threshold and current limit is set with ILIM1 and ILIM2. ILIM1 and ILIM2 are both referenced to VEE and are internally pulled up to the digital supply. Leave ILIM1 and ILIM2 unconnected to disable Class 5 detection and to be fully compliant to IEEE 802.3at standard classification. Class 5 detection is enabled, and the corresponding overcurrent threshold and current limit is adjusted, by connecting one or both to VEE (see Table 3).

2-Event PD Classification

If the result of the first classification event is Class 0 through Class 3, then only a single classification event occurs as shown in Figure 1. However, if the result is Class 4 or Class 5 (when enabled), the device performs a second classification event as shown in Figure 2. Between the classification cycles, the MAX5971B performs a first and second mark event as required by the IEEE 802.3at standard, forcing a -9.3V probing voltage at DET.

Table 2. PSE Classification of a PD (Table 33.9 of the IEEE 802.3at Standard)

MEASURED I _{CLASS} (mA)	CLASSIFICATION
0 to 5	Class 0
> 5 and < 8	Can be Class 0 or 1
8 to 13	Class 1
> 13 and < 16	Either Class 1 or 2
16 to 21	Class 2
> 21 and < 25	Either Class 2 or 3
25 to 31	Class 3
> 31 and < 35	Either Class 3 or 4
35 to 45	Class 4
> 45 and < 51	Either Class 4 or Invalid

Table 3. Class 5 Overcurrent Threshold and Current-Limit Settings

ILIM1 CONFIGURATION	ILIM2 CONFIGURATION	OVERCURRENT THRESHOLD (mA)	CURRENT LIMIT (mA)
Unconnected	Unconnected	Class 5 disabled	Class 5 disabled
VEE	Unconnected	748	850
Unconnected	VEE	792	900
VEE	VEE	836	950

MAX5971B

Single-Port, 40W, IEEE 802.3af/at, PSE Controller with I2C

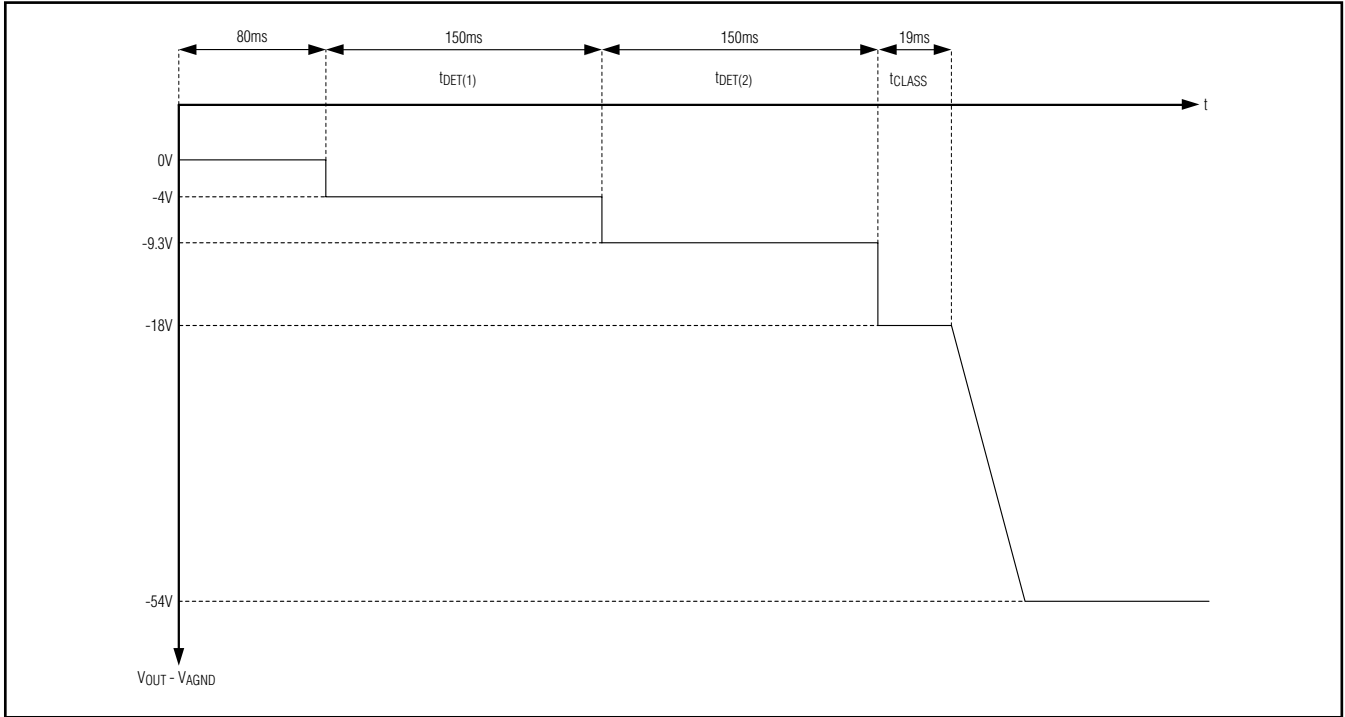

Figure 1. Detection, Classification, and Port Power-Up Sequence

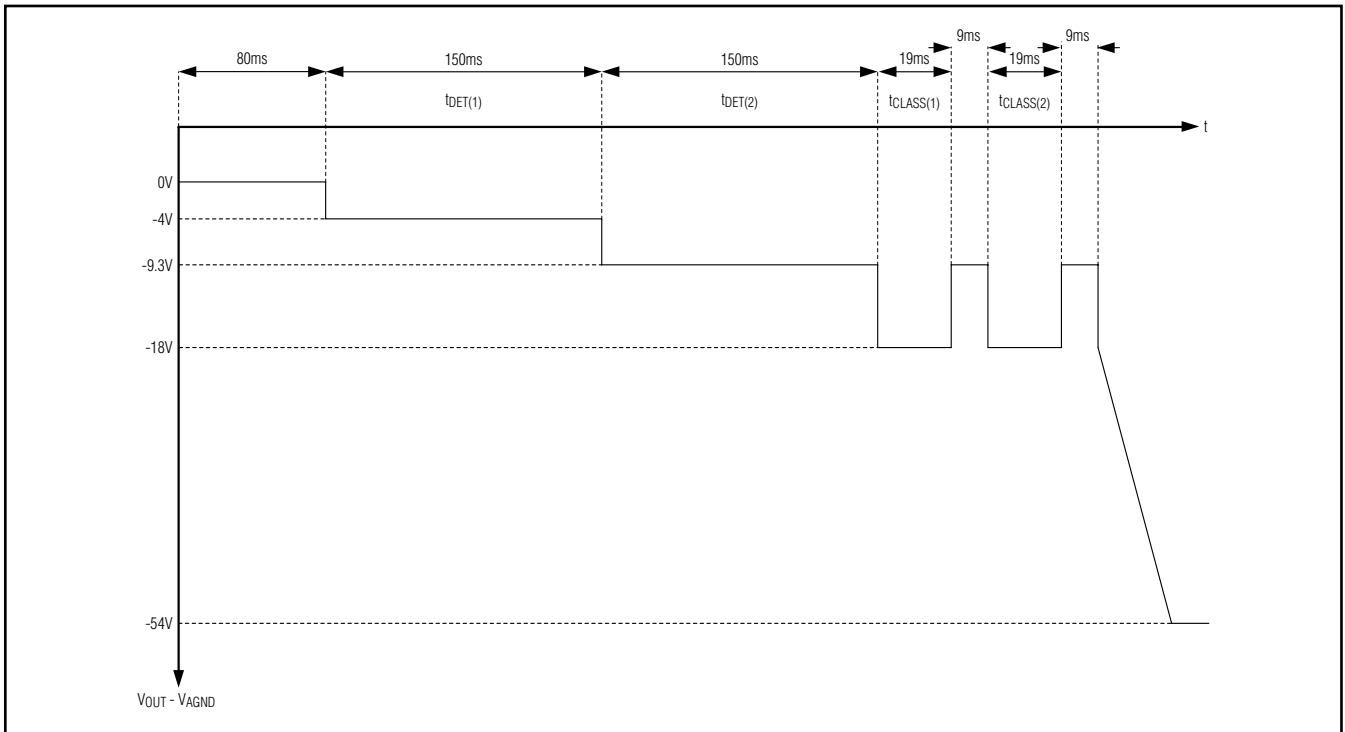

Figure 2. Detection, 2-Event Classification, and Port Power-Up Sequence

MAX5971B

Single-Port, 40W, IEEE 802.3af/at, PSE Controller with I2C

Powered State

When the MAX5971B enters a powered state, the t_{FAULT} and t_{DISC} timers are reset. When the startup timer (t_{START}) has timed out, the device enters a normal powered condition, allowing power delivery to the PD. PGOOD (R10h[4], Table 17) is set to 1 when the device enters the normal powered condition. PGOOD immediately resets to 0 whenever the power to the port is turned off. The power-good change bits, PG_CHG (R02h[4] and R03h[4], Table 9) are set both when the port powers up and when it powers down. PWR_EN (R10h[0], Table 17) is set to 1 when the port powers up and resets to 0 when a port shuts down. Set PWR_OFF (R19h[4], Table 27) to 1 to immediately turn off power to the port.

Overcurrent Protection

The MAX5971B has an internal sense resistor, RSENSE (see the *Simplified Diagram*), connected between the source of the internal MOSFET and VEE to monitor the load current. Under normal operating conditions, the current through RSENSE (IRSENSE) never exceeds the threshold ILIM. If IRSENSE exceeds ILIM, an internal current-limiting circuit regulates the gate voltage of the internal MOSFET, limiting the current. During transient conditions, if IRSENSE exceeds ILIM by more than 2A, a fast pulldown circuit activates to quickly recover from the current overshoot.

In the normal powered state, the MAX5971B checks for overcurrent conditions, as determined by $ICUT = \sim 88\%$ of ILIM. The t_{FAULT} counter sets the maximum-allowed continuous overcurrent period. This timer is incremented both in startup and in normal powered state, but under different conditions. During startup it increases when IRSENSE exceeds ILIM, while in the normal powered state the counter increases when IRSENSE exceeds ICUT. It decreases at a slower pace when IRSENSE drops below ILIM or ICUT. A slower decrement for the t_{FAULT} counter allows for detection of repeated short-duration overcurrent events. When the counter reaches the t_{FAULT} limit,

the MAX5971B powers down the port and asserts the IMAX_FLT bits (R06h[0] and R07h[0]). For a continuous overstress, a fault occurs exactly after a period of t_{FAULT} . The timing is software programmable through the timing register (R16h, Table 24).

After a power-off due to an overcurrent fault, the t_{FAULT} timer is not immediately reset but starts decrementing. The MAX5971B allows the port to be powered on only when the t_{FAULT} counter reaches zero. This feature sets an automatic port power duty-cycle protection to the internal MOSFET to avoid overheating. Through programmable registers, the MAX5971B allows the rate of decrement to be adjusted or for the restart timeout to be disabled entirely (see Tables 24 and 25).

In the normal powered state, the ILIM and ICUT thresholds are set automatically according to the classification result (see Table 4 for classification results based on detection current, and the *Electrical Characteristics* table for the corresponding thresholds). The thresholds can also be set manually by programming the ICUT register (R2Ah[2:0]). During startup, ILIM is always set to 420mA regardless of the detected class.

The ICUT Register

The ICUT register determines the maximum current limit allowed for the MAX5971B during the powered state. The ICUT bits (R2Ah[2:0]) allow manual programming of the current limit (ILIM) and overcurrent (ICUT) thresholds (see Tables 37 and 38). The ICUT register can be written to directly through the I2C interface when the automatic ICUT programming bit, CL_DISC (R17h[2]), is set to 1 (see Table 4). In this case, the current limit of the port is configured regardless of the status of the classification. By setting the CL_DISC bit to 0 (default), the MAX5971B automatically sets the ICUT register based upon the classification result (see Tables 4, 37, and 38 in the *Register Map and Description* section).

Table 4. Automatic ICUT Programming

CL_DISC (R17h[2])	PORT CLASSIFICATION RESULT	ILIM1 SETTING	ILIM2 SETTING	RESULTING ICUT REGISTER BITS (R2Ah[2:0])	CURRENT LIMIT (mA)
1	Any	—	—	User programmed	—
0	0, 1, 2, 3	—	—	ICUT = 000	420
0	4	—	—	ICUT = 001	720
0	5	VEE	Unconnected	ICUT = 101	850
0	5	Unconnected	VEE	ICUT = 110	900
0	5	VEE	VEE	ICUT = 111	950

MAX5971B

Single-Port, 40W, IEEE 802.3af/at, PSE Controller with I2C

Foldback Current

During startup and normal operation, an internal circuit senses the port voltage and reduces the current-limit value and the overcurrent threshold when $(V_{AGND} - V_{OUT}) < 27V$. The foldback function helps to reduce the power dissipation on the internal MOSFET. The current limit eventually reduces down to I_{TH_FB} (166mA, typ) when $(V_{AGND} - V_{OUT}) < 10V$ (see Figure 3).

Digital Logic

The MAX5971B internally generates digital supplies (referenced to VEE) to power the internal logic circuitry. All logic inputs and outputs are referenced to VEE. See the *Electrical Characteristics* table for digital input thresholds. If digital logic inputs are driven externally, the nominal digital logic level is 3.3V.

Interrupt

The MAX5971B contains an open-drain logic output (\overline{INT}) that goes low when an interrupt condition exists. The interrupt register (R00h, Table 7) contains the interrupt flag bits and the interrupt mask register (R01h, Table 8) determines which events can trigger an interrupt. When an event occurs, the appropriate interrupt event register bits (in R02h through R0Bh) and the corresponding interrupt (in R00h) are set to 1 and \overline{INT} is asserted low (unless masked).

As a response to an interrupt, the controller can read the status of the event register(s) to determine the cause of the interrupt and take appropriate action. Each interrupt event register is paired with a clear-on-read (CoR) register. When an interrupt event register is read through the corresponding CoR register, the interrupt register is reset to 0. \overline{INT} remains low and the interrupt is not reset when the interrupt event register is read through the read-only addresses. For example, to clear a supply event fault, read R0Bh (CoR) not R0Ah (read only, see Table 13). Use the CLR_INT bit (R1Ah[7]) to clear an interrupt, or the RESET_IC (R1Ah[4]) or RESET_P (R1Ah[0]) bit to initiate a software reset (see Table 28).

Undervoltage and Overvoltage Protection

The MAX5971B contains both undervoltage and overvoltage protection features. Table 13 in the *Register Map and Description* section shows a detailed list of the undervoltage and overvoltage protection features. An internal VEE undervoltage lockout (VEE_UVLO) circuit keeps the port off and the MAX5971B in reset until $V_{AGND} - V_{EE}$ exceeds 28.5V (typ) for more than 2.5ms. An internal VEE overvoltage (VEE_OV) circuit shuts down the port when $V_{AGND} - V_{EE}$ exceeds 62.5V (typ). The MAX5971B also features a VEE undervoltage interrupt (VEE_UV) that triggers when $V_{AGND} - V_{EE}$ drops below

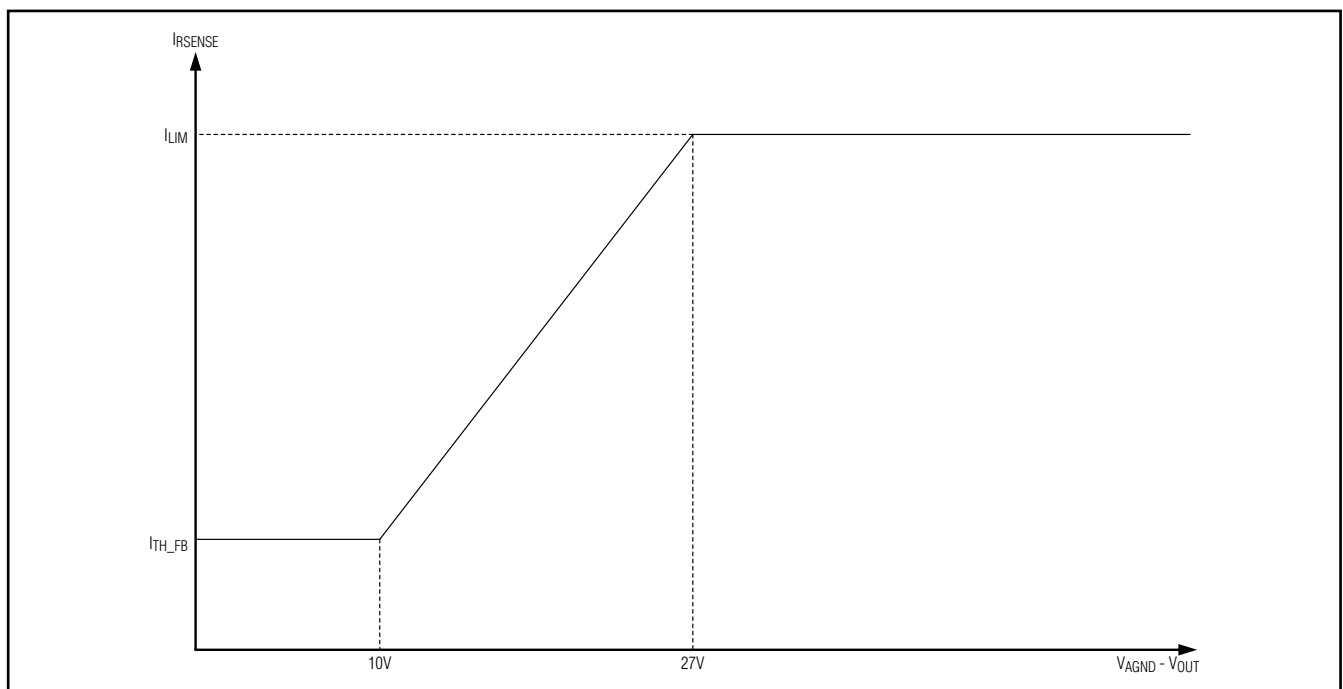

Figure 3. Foldback Current Characteristics

MAX5971B

Single-Port, 40W, IEEE 802.3af/at, PSE Controller with I2C

40V (typ). A fault latches into the supply event register VEE_UV (R0Ah[2] and R0Bh[2], Table 13) but the MAX5971B does not power down the port in this case.

DC Disconnect Monitoring

Force OSC to VEE and power or reset the device to activate DC load-disconnect monitoring. DCD_EN (R13h[0]) is set to 1 to enable DC load disconnect. If IRSENSE (the current across RSENSE) falls below the DC load-disconnect threshold, IDC_TH, for more than tDISC, the device turns off port power and sets LD_DISC in the fault event registers (R06h[4] and R07h[4]) to 1.

AC Disconnect Monitoring

The MAX5971B features AC load-disconnect monitoring. Bypass OSC with a 100nF ($\pm 10\%$ tolerance) external capacitor to VEE and power or reset the device to automatically enable AC disconnect. ACD_EN (R13h[4]) is set to 1 to enable AC disconnect (the bypass from OSC to VEE must be in place as well). When AC disconnect is enabled, a blocking diode in series to OUT and an RC circuit in parallel to the DET diode must be used, as shown in the typical operating circuit of Figure 16.

The AC disconnect uses an internal triangle-wave generator to supply the probing signal. Then the resulting

4Vp-p amplitude wave is forced on DET. The common mode of the output signal probed on DET is 5V below AGND. If the AC current peak at DET falls below IAC_TH for more than tDISC, the device powers down the port and asserts LD_DISC (R06h[4] and R07h[4]). The AC load-disconnect threshold (IAC_TH) is programmable using the AC_TH[2:0] bits (R23h[2:0], see Table 33 for settings).

PWM and LED Signals

The MAX5971B includes a multifunction LED driver to inform the user of the port status. LED is an open-drain, multifunction output referenced to VEE and can sink 10mA (typ) while driving an external LED. The LED is turned on when the port is connected to a valid PD and powered. If the port is not powered or is disconnected, the LED is off.

For two other conditions, the MAX5971B blinks a code to communicate the port status. A series of two flashes indicates an overcurrent fault occurred during port power-on, and has a timing characteristic detailed by Figure 4. A series of five flashes indicates that during detection an invalid low or high discovery signature resistance was detected, and has a timing characteristic detailed by Figure 5.

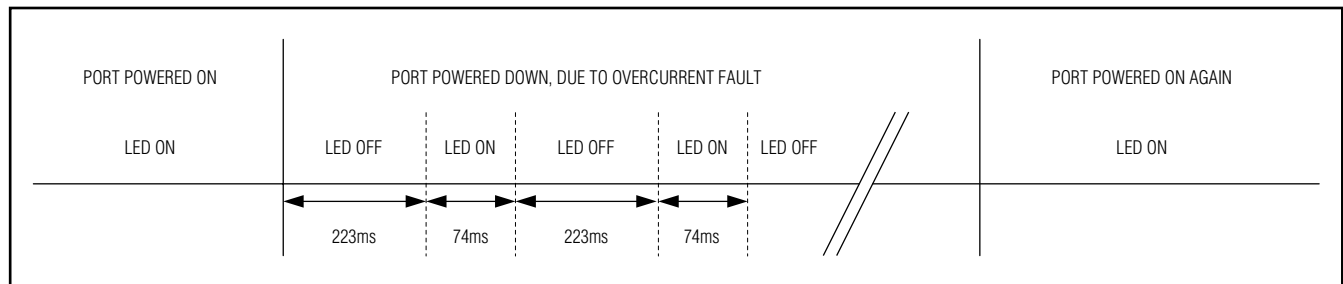

Figure 4. LED Code Timing for Overcurrent Fault During Port Power-On

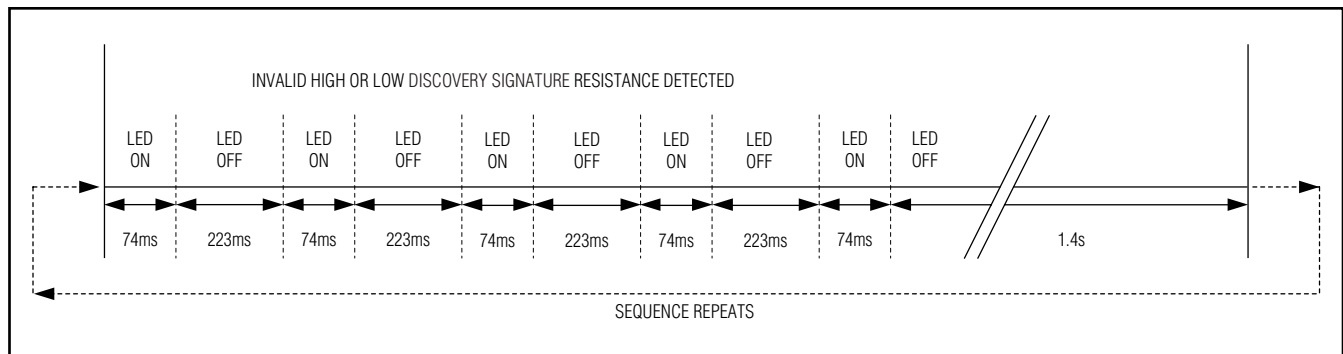

Figure 5. LED Code Timing for Detection Fault Due to High- or Low-Discovery Signature Resistance

MAX5971B

Single-Port, 40W, IEEE 802.3af/at, PSE Controller with I2C

The MAX5971B also contains an internal square wave, PWM signal generator. The PWM runs at a typical frequency of 25kHz with a default duty cycle of 6.25%. The duty cycle is programmable from 6.25% up to 25% through the PWM_TH[1:0] bits (R24h[5:4], Tables 34 and 35). PWMEN is used to enable or disable the PWM. PWMEN is internally pulled up to the digital supply, and can be left unconnected to enable the internal PWM. When enabled, the LED pulses are driven by the PWM to reduce the power dissipation and increase the system efficiency. Force PWMEN low to disable the internal PWM; LED is then driven directly.

Thermal Shutdown

If the MAX5971B die temperature reaches +150°C (typ), an overtemperature fault is generated and the device shuts down. The die temperature must cool down below 130°C (typ) to remove the overtemperature fault condition. After a thermal shutdown condition clears, the device is reset.

Watchdog

The R1Eh and R1Fh registers control the watchdog operation. The watchdog function, when enabled, allows the MAX5971B to automatically take over control and securely shut down the power to the port in case of software/firmware crashes. See the *Register Map and Description* section for register configuration and settings (Tables 30, 31, and 32).

Device Address (AD0)

The MAX5971B is programmable to one of four unique slave addresses. To program the device address, connect AD0 to V_{EE}, SCL, SDA or to an external V_{CC} supply referenced to V_{EE}. This external V_{CC} (at AD0)

must exceed the digital input logic-high threshold (V_{CC} > 2.4V, see Table 5), but should not exceed 5.5V. An external regulated 3.3V or 5V supply is recommended for V_{CC}.

I²C-Compatible Serial Interface

The MAX5971B operates as a slave that sends and receives data through an I²C-compatible 2-wire interface. The interface uses a serial-data line (SDA) and a serial-clock line (SCL) to achieve communication between master(s) and slave(s). A master (typically a microcontroller) initiates all data transfers to and from the MAX5971B, and generates the SCL clock that synchronizes the data transfer (see Figure 6).

The MAX5971B SDA line operates as both an input and an output. A pullup resistor, typically 4.7kΩ, may be required on SDA. The MAX5971B SCL line operates only as an input. A pullup resistor may be required (typically 4.7kΩ) on SCL if there are multiple masters, or if the master in a single-master system has an open-drain SCL output.

Table 5. Programmable Device Address Settings

AD0	DEVICE ADDRESS						
	A7	A6	A5	A4	A3	A2	A1
V _{EE}	0	1	0	0	0	0	0
V _{CC}	0	1	0	0	0	0	1
SCL	0	1	0	0	0	1	0
SDA	0	1	0	0	0	1	1

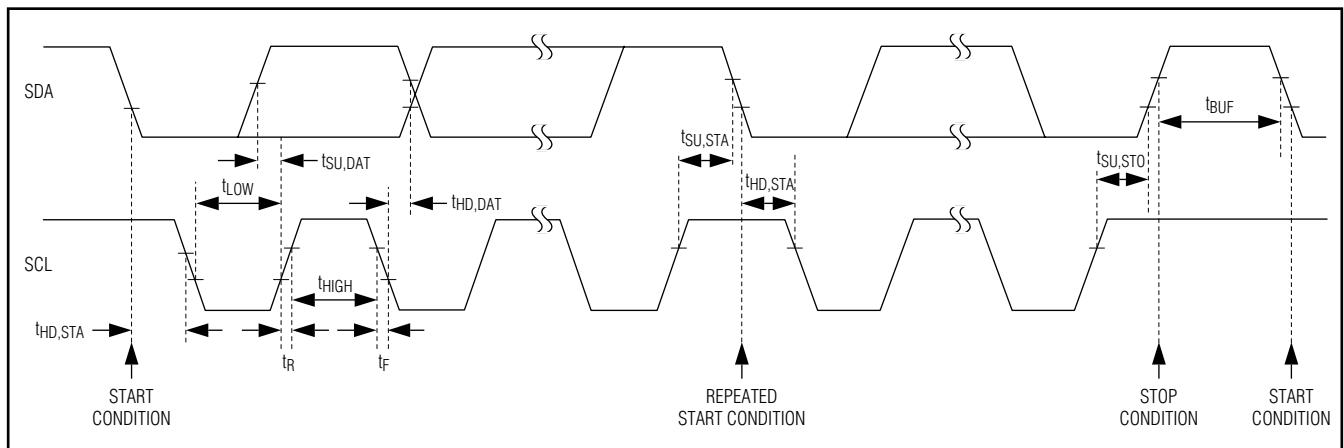

Figure 6. 2-Wire Serial Interface Timing Details

MAX5971B

Single-Port, 40W, IEEE 802.3af/at, PSE Controller with I2C

Serial-Addressing

Each transmission consists of a START condition sent by a master, followed by the MAX5971B 7-bit slave address plus R/\overline{W} bit, a register address byte, one or more data bytes, and finally a STOP condition.

START and STOP Conditions

Both SCL and SDA remain high when the interface is not busy. A master signals the beginning of a transmission with a START condition by transitioning SDA from high to low while SCL is high. When the master finishes communicating with the slave, the master issues a STOP condition by transitioning SDA from low to high while SCL is high. The STOP condition frees the bus for another transmission (see Figure 7).

Bit Transfer

Each clock pulse transfers one data bit (Figure 8). The data on SDA must remain stable while SCL is high.

Acknowledge

The acknowledge bit is a clocked 9th bit (Figure 9), which the recipient uses to handshake receipt of each byte of data. Thus each byte transferred effectively requires 9 bits. The master generates the 9th clock pulse, and the recipient pulls down SDA during the acknowledge clock pulse, so that the SDA line is stable low during the high period of the clock pulse. When the master transmits to the MAX5971B, the device generates the acknowledge bit. When the MAX5971B transmits to the master, the master generates the acknowledge bit.

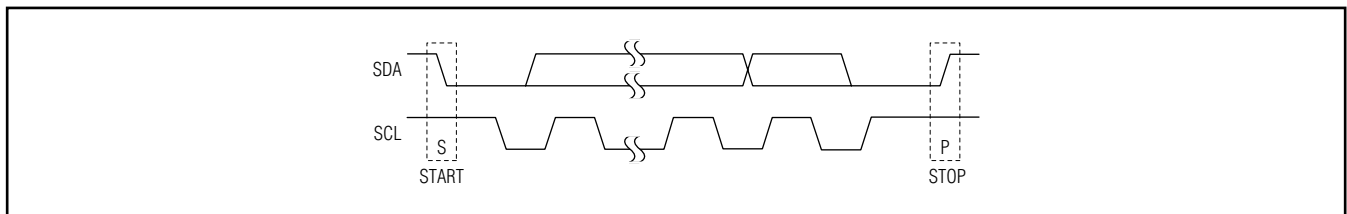

Figure 7. START and STOP Conditions

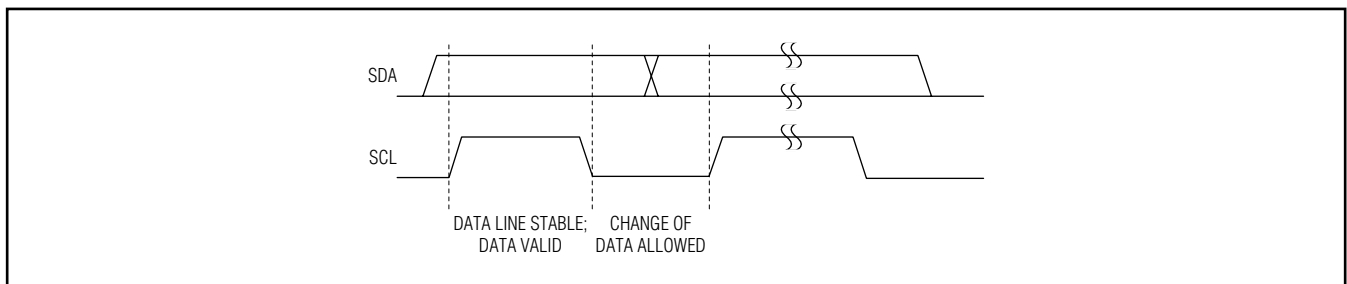

Figure 8. Bit Transfer

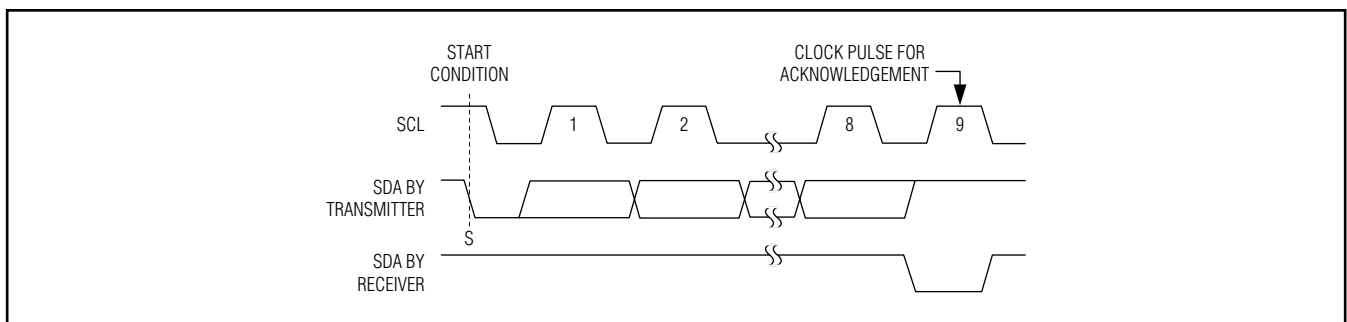

Figure 9. Acknowledge

MAX5971B

Single-Port, 40W, IEEE 802.3af/at, PSE Controller with I2C

Slave Address

The MAX5971B has a 7-bit long slave address (Figure 10). The bit following the 7-bit slave address (bit 8) is the $\overline{R/W}$ bit, which is low for a write command and high for a read command. The upper five bits of the slave address cannot be changed and are always [01000]. Using the AD0 input, the lowest two bits can be programmed to assign the MAX5971B one of 4 unique slave addresses (see Table 5). The MAX5971B monitors the bus continuously, waiting for a START condition followed by the MAX5971B's slave address. When a MAX5971B recognizes its slave address, it acknowledges and is then ready for continued communication.

Global Addressing and Alert Response Protocol

The global address call is used in writing mode to write the same register to multiple devices (address 0x60). In read mode (address 0x61), the global address call is used as the alert response address. When responding to a global call, the MAX5971B puts out on the data line its own address whenever its interrupt is active (as does every other device connected to the SDA line that has an active interrupt). After every bit transmitted, the MAX5971B checks that the data line effectively corresponds to the

data it is delivering. If it is not, it then backs off and frees the data line. This arbitration protocol always allows the part with the lowest address to complete the transmission. The microcontroller then responds to that interrupt and takes proper action. The MAX5971B does not reset its own interrupt at the end of the alert response protocol. The microcontroller has to do it by clearing the event register through their CoR addresses or activating the CLR_INT pushbutton (R1Ah[7]).

General Call

In compliance with the I²C specification, the MAX5971B responds to the general call through the global address 30h.

Message Format for Writing the MAX5971B

A write to the MAX5971B comprises the device slave address transmission with the $\overline{R/W}$ bit set to 0, followed by at least one byte of information. The first byte of information is the command byte (Figure 11). The command byte determines which register of the MAX5971B is written to by the next byte, if received. If the MAX5971B detects a STOP condition after receiving the command byte but before receiving any data, then the MAX5971B takes no further action beyond storing the command byte.

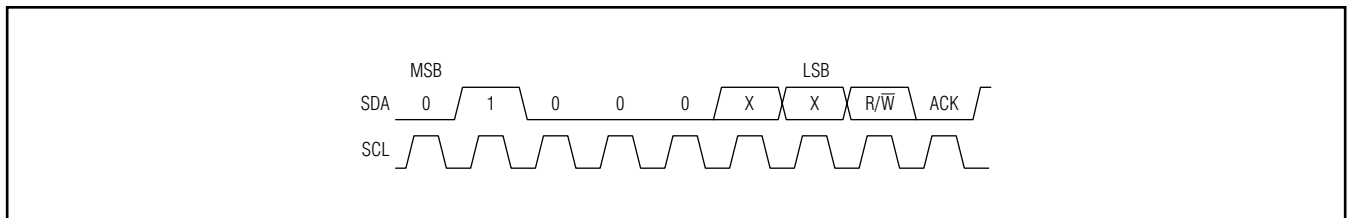

Figure 10. Slave Address

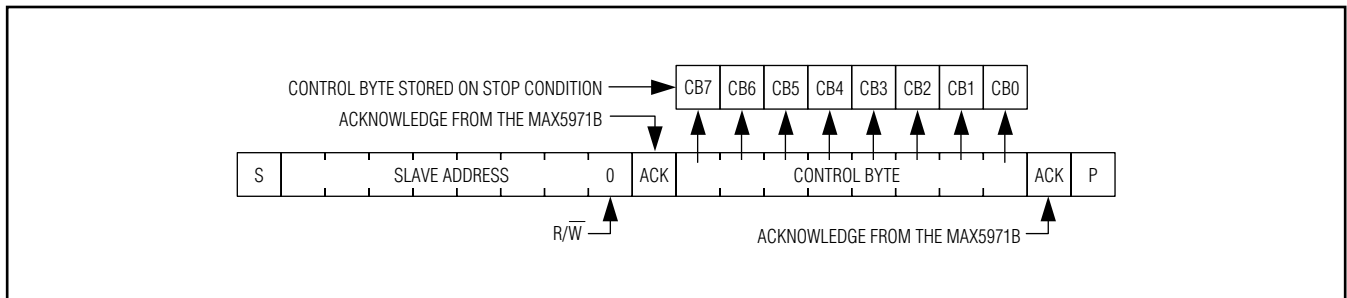

Figure 11. Write Format: Control Byte Received

MAX5971B

Single-Port, 40W, IEEE 802.3af/at, PSE Controller with I2C

Any bytes received after the command byte are data bytes. The first data byte goes into the internal register of the MAX5971B selected by the command byte (Figure 12). The control byte address then autoincrements, if possible (see Table 6), and then waits for the next data byte or a STOP condition.

If multiple data bytes are transmitted before a STOP condition is detected, these bytes are stored in subsequent MAX5971B internal registers as the control byte address autoincrements (Figure 13). If the control byte address can no longer increment, any subsequent data sent continues to write to that address.

Message Format for Reading

A read command for the MAX5971B comprises the device slave address transmission with the R/\bar{W} bit set to 1, followed by at least one byte of information. As with a write command, the first byte of information is the command byte. The MAX5971B then reads using the internally stored command byte as an address pointer, the same way the stored command byte is used as an address pointer for a write. This pointer autoincrements after reading each data byte using the same rules as for a write, though the master now sends the acknowledge bit after each read receipt (Figure 14). When performing read-after-write verification, remember to reset the command byte's address because the stored control byte address autoincrements after the write.

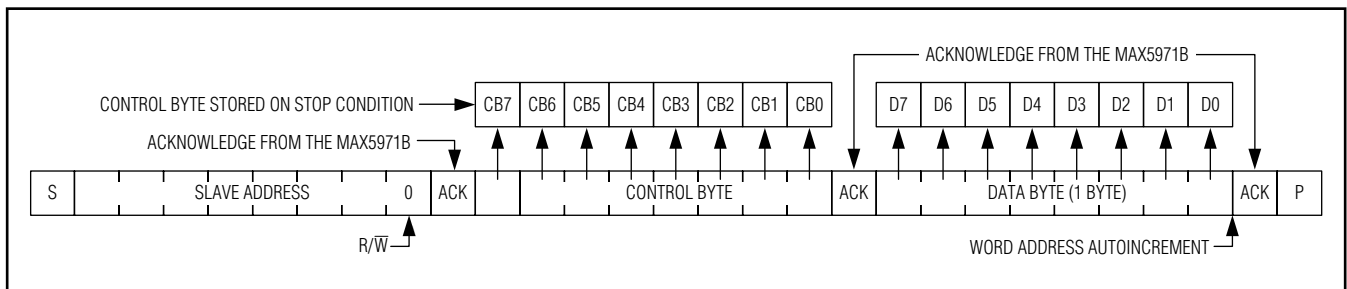

Figure 12. Write Format: Control and Single Data Byte Written

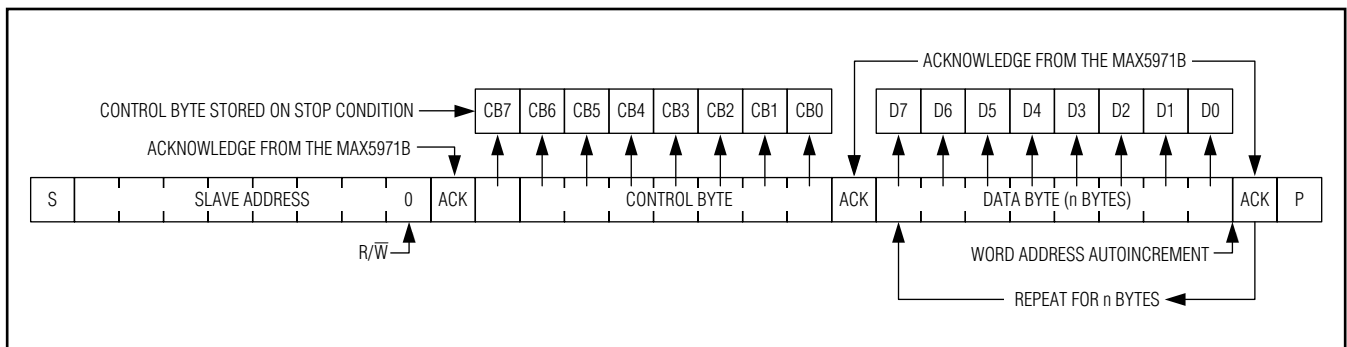

Figure 13. Write Format: Control and n Data Bytes Written

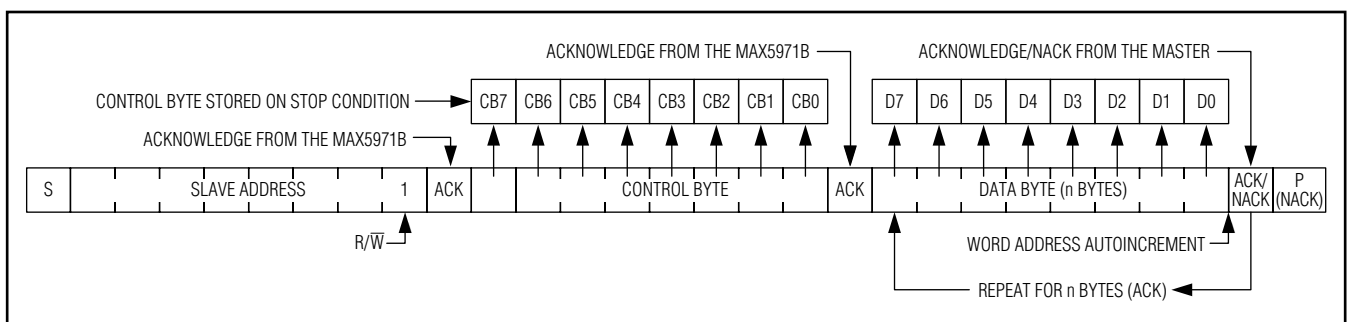

Figure 14. Read Format: Control and n Data Bytes Read

MAX5971B

Single-Port, 40W, IEEE 802.3af/at, PSE Controller with I2C

Operation with Multiple Masters

When the MAX5971B operates on a 2-wire interface with multiple masters, a master reading the MAX5971B should use repeated starts between the write that sets the MAX5971B's address pointer, and the read(s) that take the data from the location(s). It is possible for master 2 to take over the bus after master 1 has set up the MAX5971B's address pointer but before master 1 has read the data. If master 2 subsequently resets the MAX5971B's address pointer, then master 1's read may be from an unexpected location.

Command Address Autoincrementing

Address autoincrementing allows the MAX5971B to be configured with fewer transmissions by minimizing the number of times the command address needs to be sent. The command address stored in the MAX5971B generally increments after each data byte is written or read (Table 6). The MAX5971B is designed to prevent

overwrites on unavailable register addresses and unintentional wraparound of addresses.

Register Map and Description

The MAX5971B contains a bank of volatile registers that store its settings and status. The device features an I²C-compatible, 2-wire serial interface, allowing the registers to be fully software configurable and programmable. In addition to this, several registers are also pin programmable to allow the MAX5971B to operate in auto mode and still be partially configurable even without the assistance of software.

The Interrupts Registers (R00h to R01h)

Interrupt Register (R00h)

The interrupt register (R00h, Table 7) summarizes the event register status and is used to send an interrupt signal to the controller. On power-up or after a reset condition, interrupt (R00h) is set to a default value of 00h. $\overline{\text{INT}}$ goes low to report an interrupt event if any one of the active interrupt bits is set to 1 (active high) and it is not masked by the interrupt mask register (R01h, Table 8). $\overline{\text{INT}}$ does not go low to report an interrupt if the corresponding mask bit (R01h) is set. Writing a 1 to CLR_INT (R1Ah[7], Table 28) clears all interrupt and events registers (resets to low). INT_EN (R17h[7], Table 26) is a global interrupt enable and writing a 0 to INT_EN disables the $\overline{\text{INT}}$ output, putting it into a state of high impedance.

Table 6. Autoincrement Rules

COMMAND BYTE ADDRESS RANGE	AUTOINCREMENT BEHAVIOR
0x00 to 0x37	Command address autoincrements after byte read or written
0x37	Command address remains at 0x37 after byte written or read

Table 7. Interrupt Register

ADDRESS = 00h			DESCRIPTION
SYMBOL	BIT NO.	TYPE	
SUP_INT	7	R	Interrupt signal for supply faults. SUP_INT is the logic OR of all the active bits in the supply event register (R0Ah/R0Bh, Table 13).
IVC_INT	6	R	Interrupt signal for class current-limit violations. IVC_INT reports the status of IVC_FLT (bit 4) in the startup event register (R08h/R09h, Table 12).
IMAX_INT	5	R	Interrupt signal for current-limit violations. IMAX_INT reports the status of IMAX_FLT (bit 0) in the fault event register (R06h/R07h, Table 11).
CL_INT	4	R	Interrupt signal for completion of classification. CL_INT reports the status of CL_END (bit 4) in the detect event register (R04h/R05h, Table 10).
DET_INT	3	R	Interrupt signal for completion of detection. DET_INT reports the status of DET_END (bit 0) in the detect event register (R04h/R05h, Table 10).
LD_INT	2	R	Interrupt signal for load disconnection. LD_INT reports the status of LD_DISC (bit 4) in the fault event register (R06h/R07h, Table 11).
PG_INT	1	R	Interrupt signal for PGOOD (R10h[4]) status changes. PG_INT reports the status of PG_CHG (bit 4) in the power event register (R02h/R03h, Table 9).
PE_INT	0	R	Interrupt signal for power enable status change. PE_INT reports the status of PWEN_CHG (bit 0) in the power event register (R02h/R03h, Table 9).

MAX5971B

Single-Port, 40W, IEEE 802.3af/at, PSE Controller with I2C

Interrupt Mask Register (R01h)

The interrupt mask register (R01h, Table 8) contains MASK_ bits that mask the corresponding interrupt bits in register R00h (active high). Setting MASK_ bits low individually disables the corresponding interrupt signal. When masked (set low), the corresponding bits are still set in the interrupt register (R00h) but the masking bit (R01h) suppresses the generation of an interrupt signal (INT). On power-up or a reset condition, the interrupt mask register is set to a default state of A4h.

The Event Registers (R02h to R0Bh)

Power Event Register (R02h/R03h)

The power event register (R02h/R03h, Table 9) records changes in the power status of the port. On power-up or after a reset condition, the power event register is set to a default value of 00h. Any change in PGOOD (R10h[4]) sets PG_CHG to 1. Any change in PWR_EN (R10h[0]) sets PWEN_CHG to 1. PG_CHG and PWEN_CHG trigger on the edges of PGOOD and PWR_EN and do not depend on the actual logic status of the bits. The power event register has two addresses. When read through the R02h address, the content of the register is left unchanged. When read through the CoR R03h address, the register content is reset to the default state.

Table 8. Interrupt Mask Register

ADDRESS = 01h			DESCRIPTION
SYMBOL	BIT NO.	TYPE	
MASK7	7	R/W	Interrupt mask bit 7. A logic-high enables the SUP_INT interrupts. A logic-low disables the SUP_INT interrupts.
MASK6	6	R/W	Interrupt mask bit 6. A logic-high enables the IVC_INT interrupts. A logic-low disables the IVC_INT interrupts.
MASK5	5	R/W	Interrupt mask bit 5. A logic-high enables the IMAX_INT interrupts. A logic-low disables the IMAX_INT interrupts.
MASK4	4	R/W	Interrupt mask bit 4. A logic-high enables the CL_INT interrupts. A logic-low disables the CL_INT interrupts.
MASK3	3	R/W	Interrupt mask bit 3. A logic-high enables the DET_INT interrupts. A logic-low disables the DET_INT interrupts.
MASK2	2	R/W	Interrupt mask bit 2. A logic-high enables the LD_INT interrupts. A logic-low disables the LD_INT interrupts.
MASK1	1	R/W	Interrupt mask bit 1. A logic-high enables the PG_INT interrupts. A logic-low disables the PG_INT interrupts.
MASK0	0	R/W	Interrupt mask bit 0. A logic-high enables the PE_INT interrupts. A logic-low disables the PE_INT interrupts.

Table 9. Power Event Register

ADDRESS =		02h	03h	DESCRIPTION
SYMBOL	BIT NO.	TYPE	TYPE	
Reserved	7	—	—	Reserved
Reserved	6	—	—	Reserved
Reserved	5	—	—	Reserved
PG_CHG	4	R	CoR	PGOOD change event for the port
Reserved	3	—	—	Reserved
Reserved	2	—	—	Reserved
Reserved	1	—	—	Reserved
PWEN_CHG	0	R	CoR	Power enable change event for the port

MAX5971B

Single-Port, 40W, IEEE 802.3af/at, PSE Controller with I2C

Detect Event Register (R04h/R05h)

The detect event register (R04h/R05h, Table 10) records detection/classification events for the port. On power-up or after a reset condition, the detect event register is set to a default value of 00h. DET_END and CL_END are set high whenever detection/classification is completed. As with the other event registers, the detect event register has two addresses. When read through the R04h address, the content of the register is left unchanged. When read through the CoR R05h address, the register content is reset to the default state.

Fault Event Register (R06h/R07h)

The fault event register (R06h/R07h, Table 11) records load removal and overcurrent events for the port. On power-up or after a reset condition, the fault event register is set to a default value of 00h. LD_DISC is set to 1 whenever the port shuts down due to detection of load removal. IMAX_FLT is set to 1 when the port shuts down due to an extended overcurrent event after a successful startup. As with the other events registers, the fault event register has two addresses. When read through the R06h address, the content of the register is left unchanged.

When read through the CoR R07h address, the register content is reset to the default state.

Startup Event Register (R08h/R09h)

The startup event register (R08h/R09h, Table 12) records class overcurrent events for the port. On power-up or after a reset condition, the startup event register is set to a default value of 00h. IVC_FLT is set to 1 whenever a class overcurrent event occurs. The class overcurrent threshold used for the IVC_FLT bit is based upon the classification result. If automatic ICUT programming is used (default, Table 4) and ICUT is not manually reprogrammed (Tables 37 and 38), the IVC_FLT and IMAX_FLT (Table 11) flags are both set for any overcurrent event. Manually reprogramming the overcurrent threshold through ICUT settings does not affect the IVC_FLT flag thresholds, but does affect the IMAX_FLT thresholds. As with the other event registers, the startup event register has two addresses. When read through the R08h address, the content of the register is left unchanged. When read through the CoR R09h address, the register content is reset to the default state.

Table 10. Detect Event Register

ADDRESS =		04h	05h	DESCRIPTION
SYMBOL	BIT NO.	TYPE	TYPE	
Reserved	7	—	—	Reserved
Reserved	6	—	—	Reserved
Reserved	5	—	—	Reserved
CL_END	4	R	CoR	Classification completed on the port
Reserved	3	—	—	Reserved
Reserved	2	—	—	Reserved
Reserved	1	—	—	Reserved
DET_END	0	R	CoR	Detection completed on the port

Table 11. Fault Event Register

ADDRESS =		06h	07h	DESCRIPTION
SYMBOL	BIT NO.	TYPE	TYPE	
Reserved	7	—	—	Reserved
Reserved	6	—	—	Reserved
Reserved	5	—	—	Reserved
LD_DISC	4	R	CoR	Disconnect on the port
Reserved	3	—	—	Reserved
Reserved	2	—	—	Reserved
Reserved	1	—	—	Reserved
IMAX_FLT	0	R	CoR	Overcurrent on the port

MAX5971B

Single-Port, 40W, IEEE 802.3af/at, PSE Controller with I2C

Table 12. Startup Event Register

ADDRESS =		08h	09h	DESCRIPTION
SYMBOL	BIT NO.	TYPE	TYPE	
Reserved	7	—	—	Reserved
Reserved	6	—	—	Reserved
Reserved	5	—	—	Reserved
IVC_FLT	4	R	CoR	Class overcurrent on the port
Reserved	3	—	—	Reserved
Reserved	2	—	—	Reserved
Reserved	1	—	—	Reserved
Reserved	0	—	—	Reserved

Table 13. Supply Event Register

ADDRESS =		0Ah	0Bh	DESCRIPTION
SYMBOL	BIT NO.	TYPE	TYPE	
TSD	7	R	CoR	Overtemperature shutdown
Reserved	6	—	—	Reserved
Reserved	5	—	—	Reserved
VEE_UVLO	4	R	CoR	VEE undervoltage lockout condition
VEE_OV	3	R	CoR	VEE overvoltage condition
VEE_UV	2	R	CoR	VEE undervoltage condition
Reserved	1	—	—	Reserved
Reserved	0	—	—	Reserved

Table 14. Port Status Register

ADDRESS = 0Ch			DESCRIPTION
SYMBOL	BIT NO.	TYPE	
Reserved	7	—	Reserved
CLASS	6	R	CLASS[2]
	5	R	CLASS[1]
	4	R	CLASS[0]
Reserved	3	—	Reserved
DET_ST	2	R	DET_ST[2]
	1	R	DET_ST[1]
	0	R	DET_ST[0]

Supply Event Register (R0Ah/R0Bh)

The MAX5971B continuously monitors the power supplies and sets the appropriate bits in the supply event register (R0Ah/R0Bh, Table 13). On power-up or after a reset condition, the supply event register is set to a default value of 00h. VEE_OV is set to 1 whenever VEE exceeds its overvoltage threshold. VEE_UV is set to 1 whenever VEE falls below its undervoltage threshold.

A thermal shutdown circuit monitors the temperature of the die and resets the MAX5971B if the temperature exceeds +150°C. TSD is set to 1 after the MAX5971B returns to normal operation.

When VEE is below its UVLO threshold, the MAX5971B is in reset mode and securely holds the port off. When VEE rises above its UVLO threshold, the device comes out of reset and the VEE_UVLO bit in the supply event register is set to 1.

As with any of the other event registers, the supply event register has two addresses. When read through the R0Ah address, the content of the register is left unchanged. When read through the CoR R0Bh address, the register content is reset to the default state.

The Status Registers (R0Ch to R11h)

Port Status Register (R0Ch)

The port status register (R0Ch, Table 14) records the results of the port detection and classification at the end of each phase in three encoded bits. On power-up or after a reset condition, the port status register is set to a

MAX5971B

Single-Port, 40W, IEEE 802.3af/at, PSE Controller with I2C

default value of 00h. Tables 15 and 16 show the detection and classification result decoding charts, respectively. For CLC_EN = 0 (R23h[5]), the detection result is shown in Table 14. When CLC_EN = 1, the MAX5971B allows valid detection of high capacitive loads of up to 47 μ F, typ. As a protection, when POFF_CL (R12h[3], Table 19) is set to 1, the MAX5971B prohibits turning on power to the port that returns a status 111 after classification.

Reserved Registers (R0Dh to R0Fh)

Registers R0Dh to R0Fh are unconnected; writing to them has no effect (address autoincrement still functions) and a read always returns logical zeros.

Power Status Register (R10h)

The power status register (R10h, Table 17) records the current status of port power. On power-up or after a reset condition, the port is initially unpowered and the power

Table 15. Detection Result Decoding Chart

DET_ST[2:0] (ADDRESS = 0Ch)	DETECTED	DESCRIPTION
000	None	Detection status unknown (default)
001	DCP	Positive DC supply connected at the port ($V_{AGND} - V_{OUT} < 1V$)
010	HIGH CAP	High capacitance at the port ($> 8.5\mu F$, typ)
011	RLOW	Low resistance at the port ($R_{DET} < 15k\Omega$)
100	DET_OK	Detection pass ($15k\Omega < R_{DET} < 33k\Omega$)
101	RHIGH	High resistance at the port ($R_{DET} > 33k\Omega$)
110	OPEN	Open port ($I_{DET} < 20\mu A$)
111	DCN	Negative DC bias on the port ($V_{OUT} - V_{EE} < 2V$)

Table 16. Classification Result Decoding Chart

CLASS[2:0] (ADDRESS = 0Ch)	CLASS RESULT
000	Unknown
001	1
010	2
011	3
100	4
101	5
110	0
111	Class FAIL

Table 17. Power Status Register

ADDRESS = 10h			DESCRIPTION
SYMBOL	BIT NO.	TYPE	
Reserved	7	—	Reserved
Reserved	6	—	Reserved
Reserved	5	—	Reserved
PGOOD	4	R	Power-good condition on the port
Reserved	3	—	Reserved
Reserved	2	—	Reserved
Reserved	1	—	Reserved
PWR_EN	0	R	Power is enabled on the port

MAX5971B

Single-Port, 40W, IEEE 802.3af/at, PSE Controller with I2C

Table 18. Pin Status Register

To ADDRESS = 11h			DESCRIPTION
SYMBOL	BIT NO.	TYPE	
Reserved	7	—	Reserved
Reserved	6	—	Reserved
Reserved	5	—	Reserved
Reserved	4	—	Reserved
OSC	3	R	OSC input latched-in status
LEGACY	2	R	LEGACY input latched-in status
MIDSPAN	1	R	MIDSPAN input latched-in status
Reserved	0	—	Reserved

Table 19. Mode Register

ADDRESS = 12h			DESCRIPTION
SYMBOL	BIT NO.	TYPE	
Reserved	7	—	Reserved
Reserved	6	—	Reserved
Reserved	5	—	Reserved
Reserved	4	—	Reserved
POFF_CL	3	R/W	A logic-high prevents power-up after a classification failure (I > 50mA, valid only in auto mode)
Reserved	2	—	Reserved
P_M	1	R/W	P_M[1] for the port
	0	R/W	P_M[0] for the port

Table 20. Port Operating Mode Status

P_M[1:0]	DESCRIPTION
00	Shutdown
01	Manual
10	Semiautomatic
11	Auto (Automatic)

status register is set to its default value of 00h. PGOOD (R10h[4]) is set to 1 at the end of the power-up startup period. PGOOD is reset to 0 whenever a fault condition occurs. PWR_EN (R10h[0]) is set to 1 when the port power is turned on. PWR_EN resets to 0 as soon as the port turns off. Any transition of PGOOD and PWR_EN bits set the corresponding bit in the power event register (R02h/R03h, Table 9).

Pin Status Register (R11h)

The pin status register (R11h, Table 18) records the state of the OSC, LEGACY, and MIDSPAN pins. The states of OSC, LEGACY, and MIDSPAN are latched into the corresponding bits after a power-up or reset condition clears. Therefore, the default state of the pin status register depends on those inputs (0000 to xxx1). Changes to those inputs during normal operation are ignored and do not change the register contents.

Configuration Registers (R12h to R17h)

Mode Register (R12h)

The mode register (R12h, Table 19) contains two bits that set the MAX5971B mode of operation. Table 20 details how to set the mode of operation for the device. On a power-up or after a reset condition, the mode register is set to a default value of 03h. Use software to program the mode of operation. The software port specific reset using RESET_P (R1Ah[0], Table 28) does not affect the mode register. Setting POFF_CL (R12h[3]) to 1 prevents power-up after a classification failure.

MAX5971B

Single-Port, 40W, IEEE 802.3af/at, PSE Controller with I2C

Disconnect Enable Register (R13h)

The disconnect enable register (R13h, Table 21) is used to enable AC and DC load-disconnect detection. On power-up or after a reset condition, this register is reset to a default value of 000x to 000x, where the status latched in from the OSC input determines if AC or DC disconnect is set (see the *AC/DC Disconnect Monitoring* sections for details). Setting DCD_EN (R13h[0]) to 1 enables the DC load-disconnect detection feature. Setting ACD_EN (R13h[4]) to 1 enables the AC load-disconnect feature. If enabled, the load-disconnect detection starts during power mode and after startup when the PGOOD bit (R10h[4], Table 17) goes high.

Detection and Classification Enable Register (R14h)

The detection and classification enable register (R14h, Table 22) is used to enable detection and classification routines for the port. On a power-up or after a reset condition, this register is set to a default value of FFh (which corresponds to the default auto mode). Setting DET_EN (R14h[0]) and CLASS_EN (R14h[4]) to 1 enables load detection and classification, respectively. Detection always has priority over classification. For classification without detection, set the DET_EN bit to 0 and the CLASS_EN bit to 1.

When entering auto mode, R14h defaults to FFh. When entering semi or manual modes, R14h defaults to 00h. In manual mode, R14h works like a pushbutton. Set the bits high to launch the corresponding routine. The bit then clears after one complete detection or classification cycle finishes.

Table 21. Disconnect Enable Register

ADDRESS = 13h			DESCRIPTION
SYMBOL	BIT NO.	TYPE	
Reserved	7	—	Reserved
Reserved	6	—	Reserved
Reserved	5	—	Reserved
ACD_EN	4	R/W	Enable AC disconnect detection on the port
Reserved	3	—	Reserved
Reserved	2	—	Reserved
Reserved	1	—	Reserved
DCD_EN	0	R/W	Enable DC disconnect detection on the port

Table 22. Detection And Classification Enable Register

ADDRESS = 14h			DESCRIPTION
SYMBOL	BIT NO.	TYPE	
Reserved	7	—	Reserved
Reserved	6	—	Reserved
Reserved	5	—	Reserved
CLASS_EN	4	R/W	Enable classification on the port
Reserved	3	—	Reserved
Reserved	2	—	Reserved
Reserved	1	—	Reserved
DET_EN	0	R/W	Enable detection on the port

MAX5971B

Single-Port, 40W, IEEE 802.3af/at, PSE Controller with I2C

Backoff Enable Register (R15h)

The backoff enable register (R15h, Table 23) is used to control cadence timing (midspan) for the port. On a power-up or after a reset condition, this register is set to a default value of 0000 to 000x where x is the latched in value of the MIDSPAN input. Setting BCKOFF (R15h[0]) to 1 enables cadence timing where the port backs off and waits 2.2s (typ) after each failed load detection. The IEEE 802.3af/at standard requires a PSE that delivers power through the spare pairs (midspan) to have cadence timing (see the *Midspan Mode* section for details).

Timing Register (R16h)

The timing register (R16h, Table 24) is used to program the restart, startup, overcurrent, and load-disconnect timers for the port. On a power-up or after a reset condition, the timing register is set to a default value of 00h. To program the timer values, set the bits in R16h to scale the t_{DISC}, t_{FAULT}, t_{START}, and t_{RESTART} to a multiple of their nominal value specified in the *Electrical Characteristics* table.

TDISC[1:0] (R16h[1:0]) is used to program the load-disconnect detection time (t_{DISC}). The device turns off power to the port if it fails to provide a minimum power maintenance signal for longer than the programmed load-disconnect detection time. TFAULT[1:0] (R16h[3:2]) programs the overcurrent fault time (t_{FAULT}). Fault time is the time allowed for the port to remain in an overcurrent state both during startup and normal operation (see the *Overcurrent Protection* section). TSTART[1:0] (R16h[5:4]) programs the startup timer (t_{START}). Startup time is the time the port is allowed to be in current limit during startup. RSTR[1:0] programs the discharge rate of the TFAULT counter (t_{RESTART}) and effectively sets the time the port remains off after an overcurrent fault.

When the MAX5971B shuts down a port due to an extended overcurrent condition (either during startup or normal operation), if RSTR_EN (R17h[6]) is set high, the part does not allow the port to power back on before the restart timer (t_{RESTART}) returns to zero. This effectively sets a minimum duty cycle that protects the external MOSFET from overheating during a prolonged output overcurrent condition.

Table 23. Backoff Enable Register

ADDRESS = 15h			DESCRIPTION
SYMBOL	BIT NO.	TYPE	
Reserved	7	—	Reserved
Reserved	6	—	Reserved
Reserved	5	—	Reserved
Reserved	4	—	Reserved
Reserved	3	—	Reserved
Reserved	2	—	Reserved
Reserved	1	—	Reserved
BCKOFF	0	R/W	Enable cadence timing on the port

Table 24. Timing Register

ADDRESS = 16h			DESCRIPTION
SYMBOL	BIT NO.	TYPE	
RSTR[1]	7	R/W	Restart timer programming bit 1
RSTR[0]	6	R/W	Restart timer programming bit 0
TSTART[1]	5	R/W	Startup timer programming bit 1
TSTART[0]	4	R/W	Startup timer programming bit 0
TFAULT[1]	3	R/W	Overcurrent timer programming bit 1
TFAULT[0]	2	R/W	Overcurrent timer programming bit 0
TDISC[1]	1	R/W	Load-disconnect timer programming bit 1
TDISC[0]	0	R/W	Load-disconnect timer programming bit 0

MAX5971B

Single-Port, 40W, IEEE 802.3af/at, PSE Controller with I2C

Table 25. Timer Values for Timing Register

BIT [1:0] (ADDRESS = 16h)	tRESTART	tDISC	tSTART	tFAULT
00	16 x tFAULT	tDISC nominal (350ms, typ)	tSTART nominal (60ms, typ)	tFAULT nominal (60ms, typ)
01	32 x tFAULT	¼ x tDISC nominal	½ x tSTART nominal	½ x tFAULT nominal
10	64 x tFAULT	½ x tDISC nominal	2 x tSTART nominal	2 x tFAULT nominal
11	0 x tFAULT	2 x tDISC nominal	4 x tSTART nominal	4 x tFAULT nominal

Table 26. Miscellaneous Configurations 1 Register

ADDRESS = 17h			DESCRIPTION
SYMBOL	BIT NO.	TYPE	
INT_EN	7	R/W	A logic-high enables $\overline{\text{INT}}$ functionality
RSTR_EN	6	R/W	A logic-high enables the autorestart protection timer (set by the RSTR[1:0] bits)
Reserved	5	—	Reserved
Reserved	4	—	Reserved
Reserved	3	—	Reserved
CL_DISC	2	R/W	A logic-high enables current-limit programming regardless of the classification result through the ICUT[2:0] register
OUT_ISO	1	R/W	A logic-high forces DET to a high-impedance state. Does not interfere with other circuit operation.
HP_TIME	0	R/W	A logic-high enables the higher current limit for Type 2 PDs during startup.

Miscellaneous Configuration 1 Register (R17h)

The miscellaneous configuration 1 register (R17h, Table 26) is used for several functions that do not cleanly fit within one of the other configuration categories. On a power-up or after a reset condition, this register is set to a default value of 0xC0h. Therefore, by default, INT_EN (R17h[7]) and RSTR_EN (R17h[6]) are set to 1, enabling both $\overline{\text{INT}}$ functionality and the autorestart protection timer. Setting CL_DISC (R17h[2]) to 1 enables current-limit programming regardless of the classification result through the ICUT[2:0] register (R2Ah). Setting OUT_ISO (R17h[1]) to 1, forces DET to a high-impedance state. Setting HP_TIME high enables the higher current limits needed for type 2 PDs even during startup (during the time after port power-up but before tSTART has expired).

Pushbutton Registers (R18h to R1Ah)

Reserved Register (R18h)

Register R18h is at this time reserved. Writing to this register has no effect (the address autoincrement still updates) and any attempt to read this register returns all zeros.

Power Enable Pushbutton Register (R19h)

The power enable pushbutton register (R19h, Table 27) is used to manually power the port on or off. On a power-up or after a reset condition, this register is set to a default value of 0x00h. Setting PWR_ON (R19h[0]) to 1 turns on power to the port. PWR_ON commands are ignored when the port is already powered and during shutdown. During detection or classification, if a 1 is written to PWR_ON, the MAX5971B gracefully terminates the detection/classification routine and turns on power to the port. The MAX5971B also ignores PWR_ON commands when operating in auto mode. Setting PWR_OFF (R19h[4]) to 1 turns off power to the port. PWR_OFF commands are ignored when the port is already off and during shutdown. After the appropriate command is executed (port power on or off), the PWR_ON/PWR_OFF bit resets back to 0.

Global Pushbutton Register (R1Ah)

The global pushbutton register (R1Ah, Table 28) is used to manually clear interrupts and to initiate global and port resets. On a power-up or after a reset condition, this register is set to a default value of 0x00h. Writing a 1 to

MAX5971B

Single-Port, 40W, IEEE 802.3af/at, PSE Controller with I2C

Table 27. Power Enable Pushbutton Register

ADDRESS = 19h			DESCRIPTION
SYMBOL	BIT NO.	TYPE	
Reserved	7	—	Reserved
Reserved	6	—	Reserved
Reserved	5	—	Reserved
PWR_OFF	4	W	A logic-high powers off the port
Reserved	3	—	Reserved
Reserved	2	—	Reserved
Reserved	1	—	Reserved
PWR_ON	0	W	A logic-high powers on the port

Table 28. Global Pushbutton Register

ADDRESS = 1Ah			DESCRIPTION
SYMBOL	BIT NO.	TYPE	
CLR_INT	7	W	A logic-high clears all interrupts
Reserved	6	—	Reserved
Reserved	5	—	Reserved
RESET_IC	4	W	A logic-high resets the entire device
Reserved	3	—	Reserved
Reserved	2	—	Reserved
Reserved	1	—	Reserved
RESET_P	0	W	A logic-high resets the port

Table 29. ID Register

ADDRESS = 1Bh			DESCRIPTION
SYMBOL	BIT NO.	TYPE	
ID_CODE	7	R	ID_CODE[4]
	6	R	ID_CODE[3]
	5	R	ID_CODE[2]
	4	R	ID_CODE[1]
	3	R	ID_CODE[0]
REV	2	R	REV[2]
	1	R	REV[1]
	0	R	REV[0]

CLR_INT (R1Ah[7]) clears all the event registers and the corresponding interrupt bits in the interrupt register (R00h, Table 7). Writing a 1 to RESET_IC (R1Ah[4]) causes a global software reset, after which all registers are set back to default values (after reset condition clears). Writing a 1 to RESET_P (R1Ah[0]) turns off power to the port and resets only the port status and event registers. After the appropriate command is executed, the bits in the global pushbutton register all reset to 0.

General Registers (R1Bh to R1Fh)

ID Register (R1Bh)

The ID register (R1Bh, Table 29) keeps track of the device ID number and revision. The MAX5971B's ID code is stored in ID_CODE[4:0] (R1Bh[7:3]) and is 10000. Contact the factory for the value of the revision code stored in REV[2:0] (R1Bh[2:0]) that corresponds to the device lot number.

MAX5971B

Single-Port, 40W, IEEE 802.3af/at, PSE Controller with I2C

SMODE Register (R1Ch)

The SMODE register (R1Ch, Table 30) contains the port hardware control flag. On a power-up or after a reset condition, this register is set to a default value of 0x00h. Enable the SMODE function by setting EN_WHDOG (R1Fh[7], Table 32) to 1. The SMODE bit goes high when the watchdog counter reaches zero and the port switches over to hardware-controlled mode. SMODE also goes high each and every time the software tries to power on a port, but is denied since the port is in hardware mode.

Reserved Register (R1Dh)

Register R1Dh is at this time reserved. Writing to this register is not recommended as it is internally connected. If the software needs to do a large batch write command using the address autoincrement function, write a code of 0x00h to this register to safely autoincrement past it, and then continue the write commands as normal.

Watchdog Register (R1Eh)

The watchdog register (R1Eh, Table 31) is used to configure the watchdog timer duration. On a power-up or after a reset condition, this register is set to a default

value of 0x00h. Set EN_WHDOG (R1Fh[7], Table 32) to 1 to enable the watchdog function.

When activated, the watchdog timer counter, WDTIME[7:0] (R1Eh[7:0]), continuously decrements toward zero once every 164ms. Use software to initially set WDTIME[7:0] to a nonzero value. Then, once the watchdog function is active the software must continue to set the watchdog register to a nonzero value before the decrementing value stored in the register reaches zero. Once the counter reaches zero (also called watchdog expiry), the MAX5971B enters hardware-controlled mode and the port shifts to an operating mode set by the HWMODE bit (R1Fh[0], Table 32). In this way, the hardware can gracefully manage the port power during a software crash, system crash or switchover condition.

While in hardware-controlled mode, the MAX5971B ignores all requests to turn the power on and the flag SMODE indicates that the hardware has taken control of the MAX5971B operation. In addition, the software is not allowed to change the mode of operation in hardware-controlled mode.

Table 30. SMODE Register

ADDRESS = 1Ch			DESCRIPTION
SYMBOL	BIT NO.	TYPE	
Reserved	7	—	Reserved
Reserved	6	—	Reserved
Reserved	5	—	Reserved
Reserved	4	—	Reserved
Reserved	3	—	Reserved
Reserved	2	—	Reserved
Reserved	1	—	Reserved
SMODE	0	CoR	Port hardware control flag

Table 31. Watchdog Register

ADDRESS = 1Eh			DESCRIPTION
SYMBOL	BIT NO.	TYPE	
WDTIME	7	R/W	WDTIME[7]
	6	R/W	WDTIME[6]
	5	R/W	WDTIME[5]
	4	R/W	WDTIME[4]
	3	R/W	WDTIME[3]
	2	R/W	WDTIME[2]
	1	R/W	WDTIME[1]
	0	R/W	WDTIME[0]

MAX5971B

Single-Port, 40W, IEEE 802.3af/at, PSE Controller with I2C

Switch Mode Register (R1Fh)

The switch mode register (R1Fh, Table 32) is used to enable the watchdog timer, interrupt, and watchdog expiry port state. On a power-up or after a reset condition, this register is set to a default value of 0x00h.

Set EN_WHDOG (R1Fh[7], Table 32) to 1 to enable the watchdog function. When the watchdog counter reaches zero, the hardware-controlled mode activates and sets the port to the operating mode determined by the HWMODE bit (R1Fh[0]). A 0 in HWMODE places the port into shutdown mode by setting the P_M[1:0] bits (R12h[1:0]) to 00. A 1 in HWMODE places the port into auto mode by setting the P_M[1:0] bits to 11. If WD_INT_EN is set to 1, an interrupt is sent if the SMODE bit is set.

Special and Reserved Registers (R20h to R2Fh)

Reserved Registers

(R20h to R22h, R25h to R28h, and R2Bh to R2Fh)

These registers are reserved. Writing to these registers is not recommended as they are internally connected. If

the software needs to do a large batch write command using the address autoincrement function, write a code of 0x00h to these registers to safely autoincrement past them, and then continue the write commands as normal.

Program Register (R23h)

The program register (R23h, Table 33) is used to enable large capacitor detection, skipping detection in AUTO mode and for setting the AC disconnect threshold. On a power-up or after a reset condition, this register is set to a default value of 00x0 to 0100.

CLC_EN (R23h[5]) enables the large capacitor detection feature. The CLC_EN register can be programmed directly by the software or by using the LEGACY input (see the *High Capacitance Detection* section). When CLC_EN = 1 the device can recognize a capacitor load up to 47µF, typ. If the CLC_EN = 0, the MAX5971B performs normal detection.

DET_BY (R23h[4]) is used to allow the port to power when skipping the detection routine in auto mode. When DET_BY is set to 0 (default), the port cannot power up if the port detection sequence was bypassed in auto

Table 32. Switch Mode Register

ADDRESS = 1Fh			DESCRIPTION
SYMBOL	BIT NO.	TYPE	
EN_WHDOG	7	R/W	A logic-high enables the watchdog function
WD_INT_EN	6	R/W	Enables interrupt on SMODE bit
Reserved	5	—	Reserved
Reserved	4	—	Reserved
Reserved	3	—	Reserved
Reserved	2	—	Reserved
Reserved	1	—	Reserved
HWMODE	0	R/W	Port switches to auto mode if logic-high and to shutdown mode if logic-low when watchdog timer expires

Table 33. Program Register

ADDRESS = 23h			DESCRIPTION
SYMBOL	BIT NO.	TYPE	
Reserved	7	R/W	Internally connected. For a write command, always write a zero to this bit.
	6	R/W	
CLC_EN	5	R/W	Large capacitor detection enable
DET_BY	4	R/W	Enables skipping detection in auto mode
Reserved	3	—	Reserved
AC_TH	2	R/W	AC_TH[2]
	1	R/W	AC_TH[1]
	0	R/W	AC_TH[0]

MAX5971B

Single-Port, 40W, IEEE 802.3af/at, PSE Controller with I2C

mode. When DET_BY is set to 1 however, the MAX5971B can power the port without doing the detection routine.

AC_TH[2:0] (R23h[2:0]) allows direct programming of the AC disconnect threshold. The threshold is defined as a current since the comparator verifies that the peak current pulses sensed at the DET input exceeds a preset threshold. The current threshold is defined as follows:

$$I_{AC_TH} = 85.28\mu A + 10.64\mu A \times N_{AC_TH}$$

where N_{AC_TH} is the decimal value of AC_TH[2:0]. The default N_{AC_TH} is 4 (AC_TH[2:0] = 100) which corresponds to a default I_{AC_TH} of ~128μA.

PWM Register (R24h)

The PWM register (R24h, Table 34) is used to program the PWM duty cycle. On a power-up or after a reset condition, this register is set to a default value of 0x00h. PWM_TH[1:0] (R24h[5:4]) is used to set the PWM duty cycle. The default PWM_TH[1:0] value of 00 corresponds to a 6.25% duty cycle, while the maximum PWM_TH[1:0] value of 11 corresponds to a 25% duty cycle (see Table 35).

Table 34. PWM Register

ADDRESS = 24h			DESCRIPTION
SYMBOL	BIT NO.	TYPE	
Reserved	7	—	Reserved
Reserved	6	—	Reserved
PWM_TH	5	R/W	PWM_TH[1]
	4	R/W	PWM_TH[0]
Reserved	3	R/W	Internally connected. For a write command, always write a zero to this bit.
	2	R/W	
	1	R/W	
	0	R/W	

Table 35. PWM Duty-Cycle Settings

PWM_TH[1:0]	DUTY CYCLE (%)
00	6.25
01	12.5
10	18.75
11	25.0

MAX5971B

Single-Port, 40W, IEEE 802.3af/at, PSE Controller with I2C

Miscellaneous Configurations 2 Register (R29h)

The miscellaneous configurations 2 register (R29h, Table 36) is used to enable the load stability safety check (see the *PD Detection* section). On a power-up or after a reset condition, this register is set to a default value of 0x00h.

ICUT Register (R2Ah)

The ICUT register (R2Ah, Table 37) is used to adjust the device current limit and corresponding overcurrent thresholds. On a power-up or after a reset condition, this register is set to a default value of 0x00h. The MAX5971B can automatically set the ICUT register (see Table 4) or ICUT[2:0] can be manually written to by the software (see Table 38) to manually adjust the current-limit and overcurrent thresholds.

Table 36. Miscellaneous Configurations 2 Register

ADDRESS = 29h			DESCRIPTION
SYMBOL	BIT NO.	TYPE	
Reserved	7	—	Reserved
Reserved	6	—	Reserved
Reserved	5	—	Reserved
LSC_EN	4	R/W	Enables the load stability safety check
Reserved	3	R/W	Internally connected. For a write command, always write a zero to this bit.
Reserved	2	R/W	
Reserved	1	—	Reserved
Reserved	0	—	Reserved

Table 37. ICUT Register

ADDRESS = 2Ah			DESCRIPTION
SYMBOL	BIT NO.	TYPE	
Reserved	7	—	Reserved
Reserved	6	—	Reserved
Reserved	5	—	Reserved
Reserved	4	—	Reserved
Reserved	3	—	Reserved
ICUT	2	R/W	ICUT[2]
	1	R/W	ICUT[1]
	0	R/W	ICUT[0]

Table 38. ICUT Current-Limit Threshold Settings

ICUT[2:0]	TYPICAL CURRENT-LIMIT THRESHOLD (mA)	TYPICAL OVERCURRENT THRESHOLD (mA)
000	420	370
001	720	634
010	126	111
011	223	196
100	Not Used	Not Used
101	850	748
110	900	792
111	950	836

MAX5971B

Single-Port, 40W, IEEE 802.3af/at, PSE Controller with I2C

Current Readout Registers (R30h to R37h)

Port Current Registers (R30h to R31h)

The port current registers (R30h to R31h, Tables 39 and 40) provide port current readout during classification and normal power mode. On a power-up or after a reset condition, these registers are both set to a default value of 0x00h. The port current readout has 9 bits of overall resolution. The MAX5971B has 8-bit registers, so the data is split between 2 consecutive registers. R30h[7:0] contains the highest 8 bits (MSB) and R31h[0] contains the lowest bit (LSB). To avoid the LSB register changing while reading the MSB, the register contents are frozen if the addressing byte points to either of the current readout registers.

When the port is powered, the port output current can be calculated as:

$$I_{OUT} = N_{IPD} \times 1.95\text{mA}$$

During classification, the port current is:

$$I_{CLASS} = N_{IPD} \times 0.0975\text{mA}$$

where N_{IPD} is the decimal value of the 9-bit port current readout. The ADC saturates both at full scale and at zero, resulting in poor current readout accuracy near the top and bottom codes.

Reserved Registers (R32h to R37h)

Registers R32h to R37h are unconnected; writing to them has no effect (address autoincrement still functions) and a read always returns logical zeros.

Table 39. Port Current Register (MSB)

ADDRESS = 30h			DESCRIPTION
SYMBOL	BIT NO.	TYPE	
IPD	7	R	IPD[8] (MSB)
	6	R	IPD[7]
	5	R	IPD[6]
	4	R	IPD[5]
	3	R	IPD[4]
	2	R	IPD[3]
	1	R	IPD[2]
	0	R	IPD[1]

Table 40. Port Current Register (LSB)

ADDRESS = 31h			DESCRIPTION
SYMBOL	BIT NO.	TYPE	
Reserved	7	—	Reserved
Reserved	6	—	Reserved
Reserved	5	—	Reserved
Reserved	4	—	Reserved
Reserved	3	—	Reserved
Reserved	2	—	Reserved
Reserved	1	—	Reserved
IPD	0	R	IPD[0] (LSB)

MAX5971B

Single-Port, 40W, IEEE 802.3af/at, PSE Controller with I2C

Table 41. Register Summary

ADDR	REGISTER NAME	TYPE	BIT 7	BIT 6	BIT 5	BIT 4	BIT 3	BIT 2	BIT 1	BIT 0	RESET STATE
INTERRUPTS											
00h	Interrupt	R	SUP_INT	IVC_INT	IMAX_INT	CL_INT	DET_INT	LD_INT	PG_INT	PE_INT	0000-0000
01h	Interrupt Mask	R/W	MASK7	MASK6	MASK5	MASK4	MASK3	MASK2	MASK1	MASK0	1010-0100
EVENTS											
02h	Power Event	R	Reserved	Reserved	Reserved	PG_CHG	Reserved	Reserved	Reserved	PWEN_CHG	0000-0000
03h	Power Event CoR	CoR									
04h	Detect Event	R	Reserved	Reserved	Reserved	CL_END	Reserved	Reserved	Reserved	DET_END	0000-0000
05h	Detect Event CoR	CoR									
06h	Fault Event	R	Reserved	Reserved	Reserved	LD_DISC	Reserved	Reserved	Reserved	IMAX_FLT	0000-0000
07h	Fault Event CoR	CoR									
08h	Startup Event	R	Reserved	Reserved	Reserved	IVC_FLT	Reserved	Reserved	Reserved	Reserved	0000-0000
09h	Startup Event CoR	CoR									
0Ah	Supply Event	R	TSD	Reserved	Reserved	VEE_UVLO	VEE_OV	VEE_UV	Reserved	Reserved	0000-0000
0Bh	Supply Event CoR	CoR									
STATUS											
0Ch	Port Status	R	Reserved	CLASS[2]	CLASS[1]	CLASS[0]	Reserved	DET_ST[2]	DET_ST[1]	DET_ST[0]	0000-0000
0Dh	Reserved	—	Reserved	Reserved	Reserved	Reserved	Reserved	Reserved	Reserved	Reserved	—
0Eh	Reserved	—	Reserved	Reserved	Reserved	Reserved	Reserved	Reserved	Reserved	Reserved	—
0Fh	Reserved	—	Reserved	Reserved	Reserved	Reserved	Reserved	Reserved	Reserved	Reserved	—
10h	Power Status	R	Reserved	Reserved	Reserved	PGOOD	Reserved	Reserved	Reserved	PWR_EN	0000-0000
11h	Pin Status	R	Reserved	Reserved	Reserved	Reserved	OSC	LEGACY	MIDSPAN	Reserved	0000-xxx1
CONFIGURATION											
12h	Operating Mode	R/W	Reserved	Reserved	Reserved	Reserved	POFF_CL	Reserved	P_M[1]	P_M[0]	0000-0011
13h	Disconnect Enable	R/W	Reserved	Reserved	Reserved	ACD_EN	Reserved	Reserved	Reserved	DCD_EN	000x-000x
14h	Det/Class Enable	R/W	Reserved	Reserved	Reserved	CLASS_EN	Reserved	Reserved	Reserved	DET_EN	0001-0001
15h	Backoff Enable	R/W	Reserved	Reserved	Reserved	Reserved	Reserved	Reserved	Reserved	BCKOFF	0000-000x
16h	Timing Configuration	R/W	RSTR[1]	RSTR[0]	TSTART[1]	TSTART[0]	TFAULT[1]	TFAULT[0]	TDISC[1]	TDISC[0]	0000-0000
17h	Miscellaneous Configurations 1	R/W	INT_EN	RSTR_EN	Reserved	Reserved	Reserved	CL_DISC	OUT_ISO	HP_TIME	1100-0000

MAX5971B

Single-Port, 40W, IEEE 802.3af/at, PSE Controller with I2C

Table 41. Register Summary (continued)

ADDR	REGISTER NAME	TYPE	BIT 7	BIT 6	BIT 5	BIT 4	BIT 3	BIT 2	BIT 1	BIT 0	RESET STATE
PUSHBUTTONS											
18h	Reserved	—	Reserved	Reserved	Reserved	Reserved	Reserved	Reserved	Reserved	Reserved	—
19h	Power Enable	W	Reserved	Reserved	Reserved	PWR_OFF	Reserved	Reserved	Reserved	PWR_ON	0000-0000
1Ah	Global	W	CLR_INT	Reserved	Reserved	RESET_IC	Reserved	Reserved	Reserved	RESET_P	0000-0000
GENERAL											
1Bh	ID	R	ID_CODE[4]	ID_CODE[3]	ID_CODE[2]	ID_CODE[1]	ID_CODE[0]	REV[2]	REV[1]	REV[0]	1000-0xxx
1Ch	SMODE	CoR	Reserved	Reserved	Reserved	Reserved	Reserved	Reserved	Reserved	SMODE	0000-0000
1Dh	Reserved	—	Reserved	Reserved	Reserved	Reserved	Reserved	Reserved	Reserved	Reserved	—
1Eh	Watchdog	R/W	WDTIME[7]	WDTIME[6]	WDTIME[5]	WDTIME[4]	WDTIME[3]	WDTIME[2]	WDTIME[1]	WDTIME[0]	0000-0000
1Fh	Switch Mode	R/W	EN_WHDOG	WD_INT_EN	Reserved	Reserved	Reserved	Reserved	Reserved	HWMODE	0000-0000
SPECIAL/RESERVED											
20h	Reserved	—	Reserved	Reserved	Reserved	Reserved	Reserved	Reserved	Reserved	Reserved	—
21h	Reserved	—	Reserved	Reserved	Reserved	Reserved	Reserved	Reserved	Reserved	Reserved	—
22h	Reserved	—	Reserved	Reserved	Reserved	Reserved	Reserved	Reserved	Reserved	Reserved	—
23h	Program	R/W	Reserved	Reserved	CLC_EN	DET_BY	Reserved	AC_TH[2]	AC_TH[1]	AC_TH[0]	00x0-0100
24h	PWM	R/W	Reserved	Reserved	PWM_TH[1]	PWM_TH[0]	Reserved	Reserved	Reserved	Reserved	0000-0000
25h	Reserved	—	Reserved	Reserved	Reserved	Reserved	Reserved	Reserved	Reserved	Reserved	—
26h	Reserved	—	Reserved	Reserved	Reserved	Reserved	Reserved	Reserved	Reserved	Reserved	—
27h	Reserved	—	Reserved	Reserved	Reserved	Reserved	Reserved	Reserved	Reserved	Reserved	—
28h	Reserved	—	Reserved	Reserved	Reserved	Reserved	Reserved	Reserved	Reserved	Reserved	—
29h	Miscellaneous Configurations 2	R/W	Reserved	Reserved	Reserved	LSC_EN	Reserved	Reserved	Reserved	Reserved	0000-0000
2Ah	ICUT	R/W	Reserved	Reserved	Reserved	Reserved	Reserved	ICUT[2]	ICUT[1]	ICUT[0]	0000-0000
2Bh	Reserved	—	Reserved	Reserved	Reserved	Reserved	Reserved	Reserved	Reserved	Reserved	—
2Ch	Reserved	—	Reserved	Reserved	Reserved	Reserved	Reserved	Reserved	Reserved	Reserved	—
2Dh	Reserved	—	Reserved	Reserved	Reserved	Reserved	Reserved	Reserved	Reserved	Reserved	—
2Eh	Reserved	—	Reserved	Reserved	Reserved	Reserved	Reserved	Reserved	Reserved	Reserved	—
2Fh	Reserved	—	Reserved	Reserved	Reserved	Reserved	Reserved	Reserved	Reserved	Reserved	—

MAX5971B

Single-Port, 40W, IEEE 802.3af/at, PSE Controller with I2C

Table 41. Register Summary (continued)

ADDR	REGISTER NAME	TYPE	BIT 7	BIT 6	BIT 5	BIT 4	BIT 3	BIT 2	BIT 1	BIT 0	RESET STATE
CURRENT READOUT											
30h	Port Current (MSB)	R	IPD[8]	IPD[7]	IPD[6]	IPD[5]	IPD[4]	IPD[3]	IPD[2]	IPD[1]	0000-0000
31h	Port Current (LSB)	R	Reserved	Reserved	Reserved	Reserved	Reserved	Reserved	Reserved	IPD[0]	0000-0000
32h	Reserved	—	Reserved	Reserved	Reserved	Reserved	Reserved	Reserved	Reserved	Reserved	—
33h	Reserved	—	Reserved	Reserved	Reserved	Reserved	Reserved	Reserved	Reserved	Reserved	—
34h	Reserved	—	Reserved	Reserved	Reserved	Reserved	Reserved	Reserved	Reserved	Reserved	—
35h	Reserved	—	Reserved	Reserved	Reserved	Reserved	Reserved	Reserved	Reserved	Reserved	—
36h	Reserved	—	Reserved	Reserved	Reserved	Reserved	Reserved	Reserved	Reserved	Reserved	—
37h	Reserved	—	Reserved	Reserved	Reserved	Reserved	Reserved	Reserved	Reserved	Reserved	—

Applications Information

Layout Procedure

Careful PCB layout is critical to achieve high efficiency and low EMI. Follow these layout guidelines for optimal performance.

- 1) Place the high-frequency input bypass capacitor (0.1µF ceramic capacitor from AGND to VEE) and the output bypass capacitor (0.1µF ceramic capacitor from AGND to OUTP) as close as possible to the MAX5971B.
- 2) Use large SMT component pads for power dissipating devices, such as the MAX5971B and the external diodes in the high-power path.

- 3) Use short, wide traces whenever possible for high-power paths.
- 4) Use the MAX5971B Evaluation Kit as a design and layout reference.
- 5) The EP must be soldered evenly to the PCB ground plane (VEE) for proper operation and power dissipation. Use multiple vias beneath the EP for maximum heat dissipation. A 1.0mm to 1.2mm pitch is the recommended spacing for these vias and should be plated (1oz copper) with a small barrel diameter (0.30mm to 0.33mm).

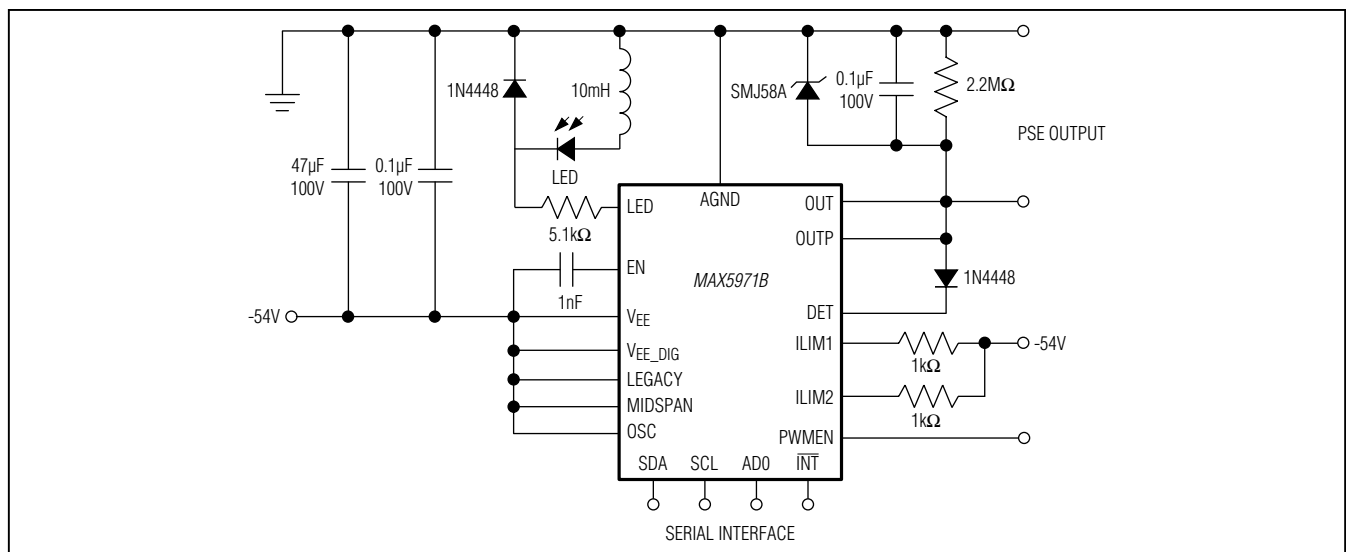

Figure 15. Typical Operating Circuit 1 (DC Load Removal Detection, Internal PWM Enabled for LED Indication, and Class 5 Detection Enabled)

MAX5971B

Single-Port, 40W, IEEE 802.3af/at, PSE Controller with I2C

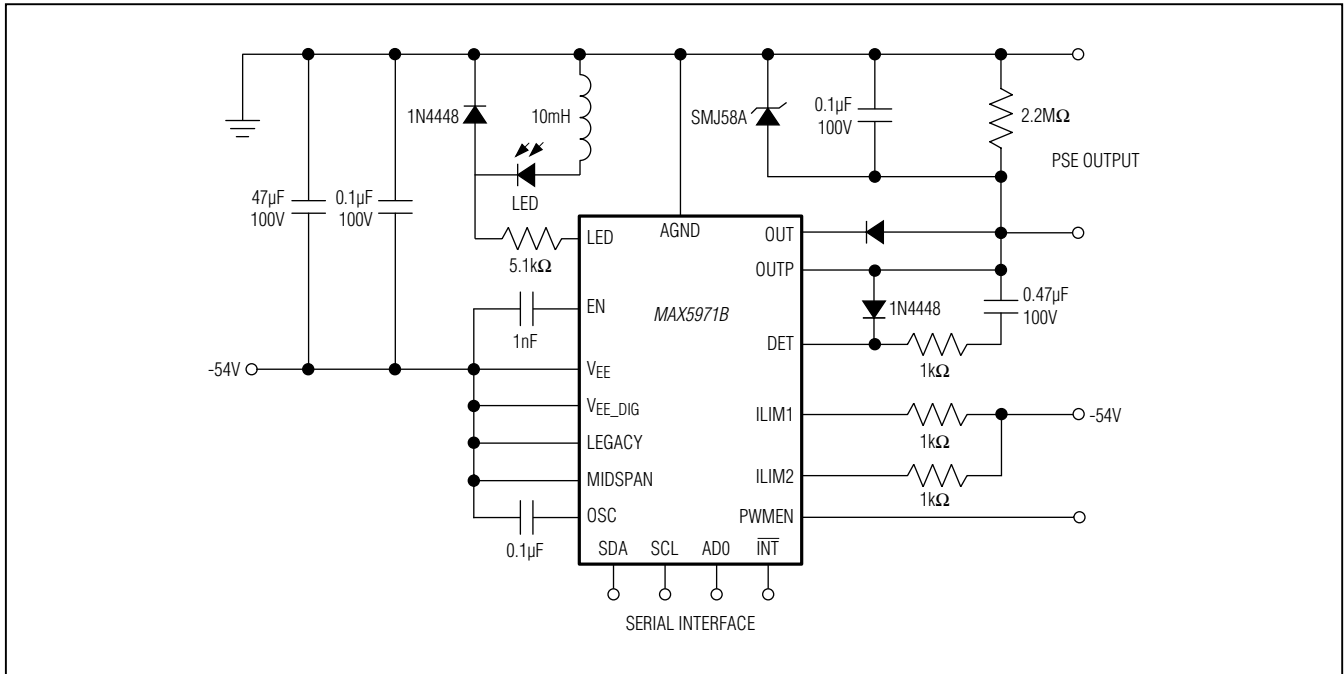

Figure 16. Typical Operating Circuit 2 (AC Load Removal Detection, Internal PWM Enabled for LED Indication, and Class 5 Detection Enabled)

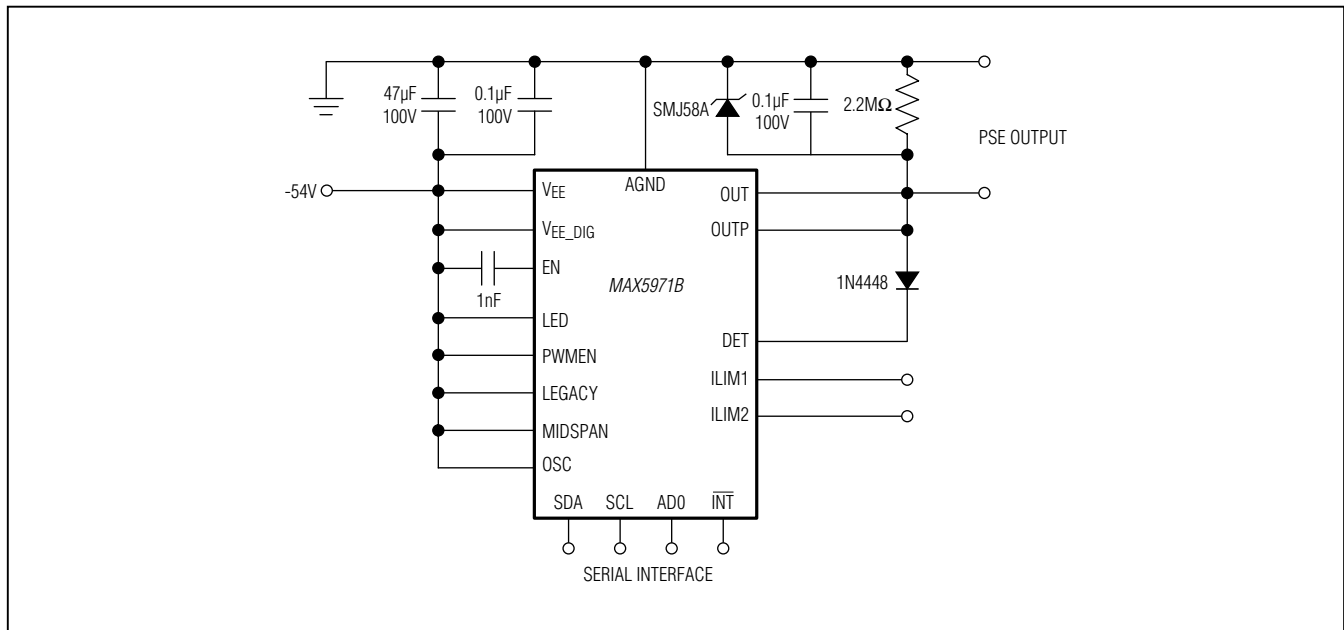

Figure 17. Typical Operating Circuit 3 (IEEE 802.3at Compliant, Minimal Application Circuit with DC Load Removal Detection and No LED Indication)

MAX5971B

Single-Port, 40W, IEEE 802.3af/at, PSE Controller with I2C

Chip Information

PROCESS: BiCMOS

Package Information

For the latest package outline information and land patterns (footprints), go to www.maximintegrated.com/packages. Note that a "+", "#", or "-" in the package code indicates RoHS status only. Package drawings may show a different suffix character, but the drawing pertains to the package regardless of RoHS status.

PACKAGE TYPE	PACKAGE CODE	OUTLINE NO.	LAND PATTERN NO.
28 TQFN-EP	T2855+6	21-0140	90-0026

MAX5971B

Single-Port, 40W, IEEE 802.3af/at, PSE Controller with I2C

Revision History

REVISION NUMBER	REVISION DATE	DESCRIPTION	PAGES CHANGED
0	6/10	Initial release	—
1	12/10	Updated current-limit, overcurrent, and ADC specifications for rev 3 silicon	2, 3, 6, 26-28
2	4/11	Corrected the I ² C section, Figure 14, and other minor edits throughout data sheet.	1, 2, 4-11, 13, 14, 18, 19, 21, 25-27, 29-31, 34, 35, 37, 39, 41-43
3	3/16	Changed temperature range from “-40°C to +85°C” to “-40°C to +105°C”	globally



Maxim Integrated cannot assume responsibility for use of any circuitry other than circuitry entirely embodied in a Maxim Integrated product. No circuit patent licenses are implied. Maxim Integrated reserves the right to change the circuitry and specifications without notice at any time. The parametric values (min and max limits) shown in the Electrical Characteristics table are guaranteed. Other parametric values quoted in this data sheet are provided for guidance.

Компания «Океан Электроники» предлагает заключение долгосрочных отношений при поставках импортных электронных компонентов на взаимовыгодных условиях!

Наши преимущества:

- Поставка оригинальных импортных электронных компонентов напрямую с производств Америки, Европы и Азии, а так же с крупнейших складов мира;
- Широкая линейка поставок активных и пассивных импортных электронных компонентов (более 30 млн. наименований);
- Поставка сложных, дефицитных, либо снятых с производства позиций;
- Оперативные сроки поставки под заказ (от 5 рабочих дней);
- Экспресс доставка в любую точку России;
- Помощь Конструкторского Отдела и консультации квалифицированных инженеров;
- Техническая поддержка проекта, помощь в подборе аналогов, поставка прототипов;
- Поставка электронных компонентов под контролем ВП;
- Система менеджмента качества сертифицирована по Международному стандарту ISO 9001;
- При необходимости вся продукция военного и аэрокосмического назначения проходит испытания и сертификацию в лаборатории (по согласованию с заказчиком);
- Поставка специализированных компонентов военного и аэрокосмического уровня качества (Xilinx, Altera, Analog Devices, Intersil, Interpoint, Microsemi, Actel, Aeroflex, Peregrine, VPT, Syfer, Eurofarad, Texas Instruments, MS Kennedy, Miteq, Cobham, E2V, MA-COM, Hittite, Mini-Circuits, General Dynamics и др.);

Компания «Океан Электроники» является официальным дистрибьютором и эксклюзивным представителем в России одного из крупнейших производителей разъемов военного и аэрокосмического назначения «JONHON», а так же официальным дистрибьютором и эксклюзивным представителем в России производителя высокотехнологичных и надежных решений для передачи СВЧ сигналов «FORSTAR».



JONHON

«JONHON» (основан в 1970 г.)

Разъемы специального, военного и аэрокосмического назначения:

(Применяются в военной, авиационной, аэрокосмической, морской, железнодорожной, горно- и нефтедобывающей отраслях промышленности)

«FORSTAR» (основан в 1998 г.)

ВЧ соединители, коаксиальные кабели, кабельные сборки и микроволновые компоненты:

(Применяются в телекоммуникациях гражданского и специального назначения, в средствах связи, РЛС, а так же военной, авиационной и аэрокосмической отраслях промышленности).



Телефон: 8 (812) 309-75-97 (многоканальный)

Факс: 8 (812) 320-03-32

Электронная почта: ocean@oceanchips.ru

Web: <http://oceanchips.ru/>

Адрес: 198099, г. Санкт-Петербург, ул. Калинина, д. 2, корп. 4, лит. А