

# MINIATURE RELAY

## 2 POLES - 1 to 2 A (For Signal Switching)

### NA Series

#### ■ FEATURES

- Slim type relay for high density mounting
  - Conforms to Telcordia specification and FCC Part 68
    - Dielectric strength 1,500 VAC between coil and contacts
    - Surge strength 2,500 V between coil and contacts (at 2 × 10 s surge wave)
  - UL, CSA recognized
  - High sensitivity and low consumption power
  - High reliability - bifurcated contacts
  - DIL pitch terminals
  - Plastic sealed type
  - RoHS compliant.
- Please see page 8 for more information



#### ■ PARTNUMBER INFORMATION

[Example]    NA   L   -   D   12   W   -   K  
                   (a)   (b)   (\*)   (c)   (d)   (e)   (f)

|     |                    |   |
|-----|--------------------|---|
| (a) | Relay type         | NA    : NA Series   |
| (b) | Coil type          | Nil    : Standard type<br>L       : Latching type             |
| (c) | Number of coil     | Nil    : Single winding type<br>D       : Double winding type |
| (d) | Coil rated voltage | 12     : 1.5...48VDC<br>: Coil rating table at page 3         |
| (e) | Contact style      | W      : Bifurcated type                                      |
| (f) | Enclosure          | K      : Plastic sealed                                       |

Note: Actual marking omits the hyphen ( - ) of (\*).

# NA SERIES

## ■ SPECIFICATION

| Item             |                              |                                   | Standard type  | Single winding latching type         | Double winding latching type |
|------------------|------------------------------|-----------------------------------|--|--------------------------------------|------------------------------|
|                  |                              |                                   | NA - ( ) W - K   | NAL - ( ) W - K                      | NAL-D ( ) W - K              |
| Contact Data     | Configuration                |                                   | 2 form C (DPDT)  |                                      |                              |
|                  | Construction                 |                                   | Bifurcated   |                                      |                              |
|                  | Material                     |                                   | Gold overlay silver alloy (AgPd)   |                                      |                              |
|                  | Resistance (Initial)         |                                   | Max. 50 mΩ at 1 A, 6 VDC   |                                      |                              |
|                  | Contact rating (resistive)   |                                   | 0.5A, 125VAC or 1A, 30VDC  |                                      |                              |
|                  | Max. carrying current        |                                   | 2A   |                                      |                              |
|                  | Max. switching voltage       |                                   | 250VAC / 220VDC  |                                      |                              |
|                  | Max. switching power         |                                   | 62.5 AV / 30W  |                                      |                              |
|                  | Max. switching current       |                                   | 2A   |                                      |                              |
|                  | Min. switching load *        |                                   | 0.01 mA, 10 mVDC   |                                      |                              |
|                  | Capacitance                  |                                   | Approx. 0.5 pF (open contacts, adjacent contacts)<br>Approx. 1.0 pF (between coil and contacts)            |                                      |                              |
| Life             | Mechanical                   |                                   | Min. 100 x 10 <sup>6</sup> operations  | Min. 10 x 10 <sup>6</sup> operations |                              |
|                  | Electrical                   |                                   | Min. 200 x 10 <sup>3</sup> operations (0.5A, 125VAC),<br>Min. 500 x 10 <sup>3</sup> operations (1A, 30VDC) |                                      |                              |
| Coil Data        | Rated power                  |                                   | 140 - 300 mW   | 100 - 150 mW                         | 200 - 300 mW                 |
|                  | Operate power                |                                   | 80 - 70 mW   | 60 - 85 mW                           | 115 - 170 mW                 |
|                  | Operating temperature range  |                                   | -40 °C to +85 °C (no frost)  |                                      |                              |
| Timing Data      | Operate (at nominal voltage) |                                   | Max. 6 ms  | Max. 6 ms (set)                      |                              |
|                  | Release (at nominal voltage) |                                   | Max. 4 ms  | Max. 6 ms (reset)                    |                              |
| Insulation       | Resistance (Initial)         |                                   | Min. 1,000MΩ at 500VDC   |                                      |                              |
|                  | Dielectric strength          | Open contacts / adjacent contacts | 1,000VAC (50/60Hz) 1min  |                                      |                              |
|                  |                              | Contacts to coil                  | 1,500VAC (50/60Hz) 1min.   | 1,000VAC (50/60Hz) 1min              |                              |
|                  | Surge strength               | Open contacts / adjacent contacts | 1,500V / 10 x 700μs standard wave  |                                      |                              |
| Coil to contacts |                              | 2,500V / 2 x 10μs standard wave   | 1,500V / 10 x 160μs standard wave  |                                      |                              |
| Other            | Vibration resistance         | Misoperation                      | 10 to 55Hz double amplitude 3.3mm  |                                      |                              |
|                  |                              | Endurance                         | 10 to 55Hz double amplitude 5.0mm  |                                      |                              |
|                  | Shock                        | Misoperation                      | 500m/s <sup>2</sup> (11 ± 1ms)   |                                      |                              |
|                  |                              | Endurance                         | 1,000m/s <sup>2</sup> (6 ± 1ms)  |                                      |                              |
|                  | Weight                       | Approximately 1.5 g               |  |                                      |                              |

\* Minimum switching loads mentioned above are reference values. Please perform the confirmation test with actual load before production since reference values may vary according to switching frequencies, environmental conditions and expected reliability levels.

# NA SERIES

## ■ COIL RATING

Standard type

| Coil Code | Rated Coil Voltage (VDC) | Coil Resistance +/- 10% (Ohm) | Must Operate Voltage (VDC) * | Must Release-Voltage (VDC) * | Max. Coil Voltage (VDC) | Rated Power (mW) |
|-----------|--------------------------|-------------------------------|------------------------------|------------------------------|-------------------------|------------------|
| 1.5       | 1.5                      | 16.1                          | +1.13                        | +0.15                        | 3.6                     | 140              |
| 3         | 3                        | 64.3                          | +2.25                        | +0.3                         | 7.2                     |                  |
| 4.5       | 4.5                      | 145                           | +3.38                        | +0.45                        | 10.8                    |                  |
| 5         | 5                        | 178                           | +3.75                        | +0.5                         | 12.0                    |                  |
| 6         | 6                        | 257                           | +4.5                         | +0.6                         | 14.4                    |                  |
| 9         | 9                        | 579                           | +6.75                        | +0.9                         | 21.6                    |                  |
| 12        | 12                       | 1,028                         | +9                           | +1.2                         | 28.8                    |                  |
| 18        | 18                       | 1,620                         | +13.5                        | +1.8                         | 36.0                    | 200              |
| 24        | 24                       | 2,880                         | +18                          | +2.4                         | 48.0                    |                  |
| 48        | 48                       | 7,680                         | +36                          | +4.8                         | 84.0                    | 300              |

Single winding latching type

| Coil Code | Rated Coil Voltage (VDC) | Coil Resistance +/- 10% (Ohm) | Set Voltage (VDC) * | Reset Voltage (VDC) * | Rated Power (mW) |
|-----------|--------------------------|-------------------------------|---------------------|-----------------------|------------------|
| 1.5       | 1.5                      | 22.5                          | +1.13               | -1.13                 | 100              |
| 3         | 3                        | 90                            | +2.25               | -2.25                 |                  |
| 4.5       | 4.5                      | 203                           | +3.38               | -3.38                 |                  |
| 5         | 5                        | 250                           | +3.75               | -3.75                 |                  |
| 6         | 6                        | 360                           | +4.5                | -4.5                  |                  |
| 9         | 9                        | 810                           | +6.75               | -6.75                 |                  |
| 12        | 12                       | 1,440                         | +9                  | -9                    |                  |
| 18        | 18                       | 2,160                         | +13.5               | -13.5                 | 150              |
| 24        | 24                       | 3,840                         | +18                 | -18                   |                  |

Note: All values in the table are valid for 20°C and zero contact current.

\* Specified operate values are valid for pulse wave voltage.

# NA SERIES

## ■ COIL RATING

Double winding latching type

| Coil Code | Rated Coil Voltage (VDC) | Coil Resistance +/- 10% (Ohm) | Set Voltage (VDC) * | Reset Voltage (VDC) * | Rated Power (mW) |     |
|-----------|--------------------------|-------------------------------|---------------------|-----------------------|------------------|-----|
| 1.5       | 1.5                      | P 11.25                       | +1.13               |                       | 200              |     |
|           |                          | S 11.25                       |                     | +1.13                 |                  |     |
| 3         | 3                        | P 45                          | +2.25               |                       |                  |     |
|           |                          | S 45                          |                     | +2.25                 |                  |     |
| 4.5       | 4.5                      | P 101                         | +3.38               |                       |                  |     |
|           |                          | S 101                         |                     | +3.38                 |                  |     |
| 5         | 5                        | P 125                         | +3.75               |                       |                  |     |
|           |                          | S 125                         |                     | +3.75                 |                  |     |
| 6         | 6                        | P 180                         | +4.5                |                       |                  |     |
|           |                          | S 180                         |                     | +4.5                  |                  |     |
| 9         | 9                        | P 405                         | +6.75               |                       |                  |     |
|           |                          | S 405                         |                     | +6.75                 |                  |     |
| 12        | 12                       | P 720                         | +9                  |                       |                  |     |
|           |                          | S 720                         |                     | +9                    |                  |     |
| 18        | 18                       | P 1,080                       | +13.5               |                       |                  | 300 |
|           |                          | S 1,080                       |                     | +13.5                 |                  |     |
| 24        | 24                       | P 1,920                       | +18                 |                       |                  |     |
|           |                          | S 1,920                       |                     | +18                   |                  |     |

Note: All values in the table are measured at 20°C and zero contact current.

P: Primary coil S: Secondary coil

\* Specified values are measured with pulse wave voltage

## ■ SAFETY STANDARDS

| Type | Compliance                        | Contact rating                                      |
|------|-----------------------------------|---|
| UL   | UL 508, UL 1950                   | Flammability: UL 94-V0 (plastics)                   |
|      | E 45026                           | 0.5A, 125VAC (general use)<br>2A, 30VDC (resistive) |
| CSA  | C22.2 No. 14, No. 950<br>LR 35579 | 0.3A, 110VDC (resistive)                            |

Complies to IEC60950-1; FCC part 68: Telcordia  
(Relay is only marked with UL and CSA logo)

## CHARACTERISTIC DATA

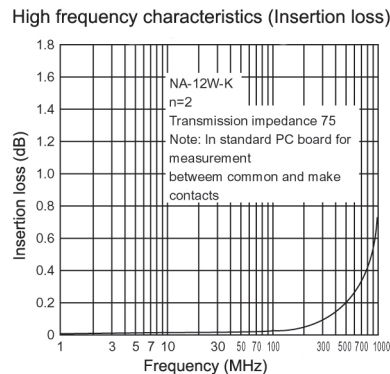
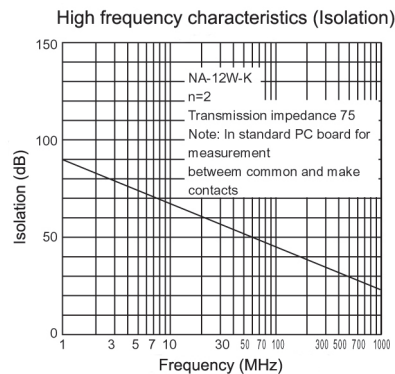
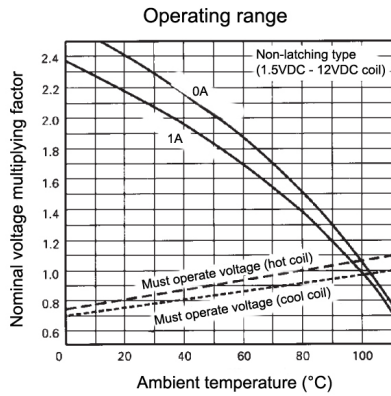
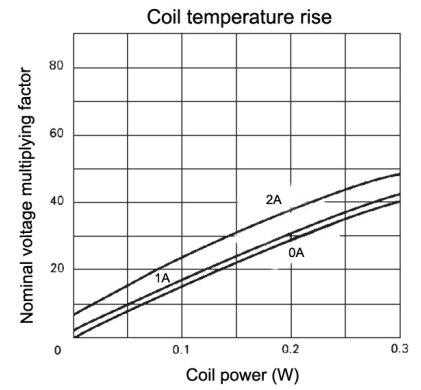
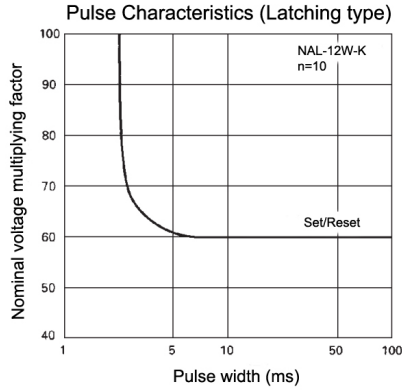
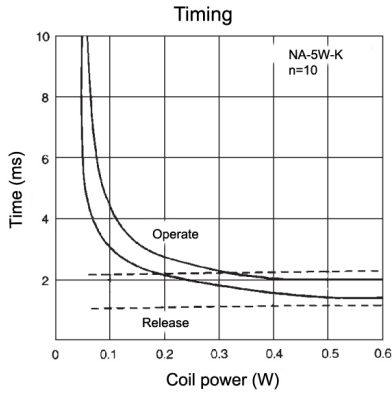

## ■ REFERENCE DATA

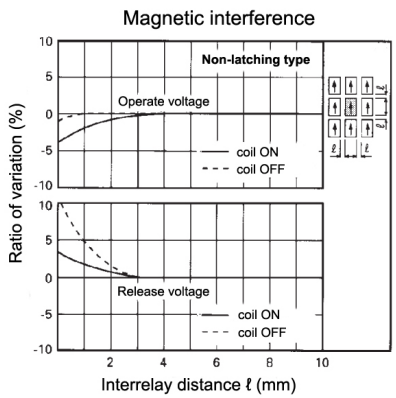
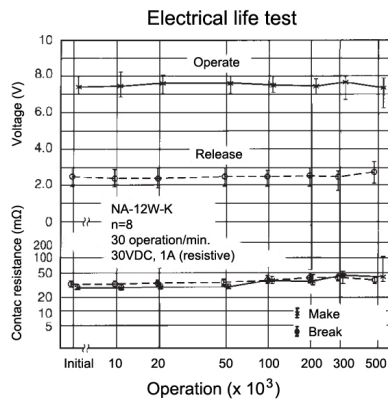
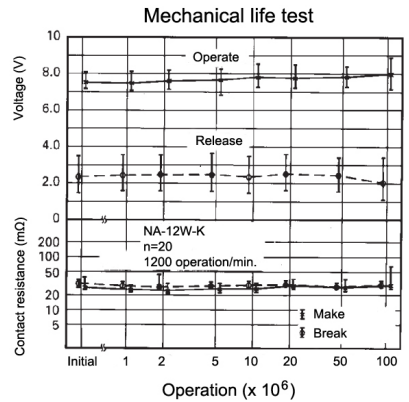
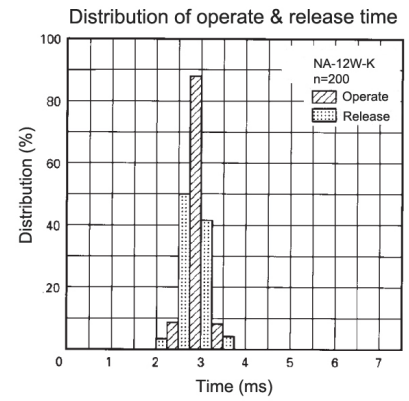

# NA SERIES

## ■ DIMENSIONS

- Dimensions

NA, NAL (Standard type, Single winding latching type)

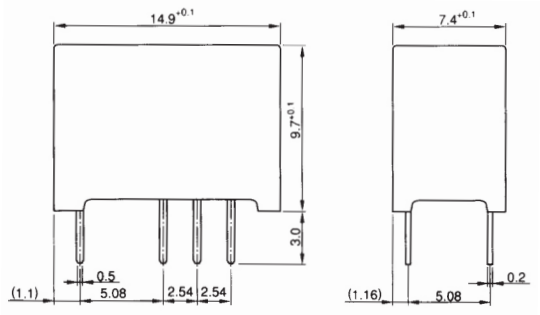

- Schematics (BOTTOM VIEW)

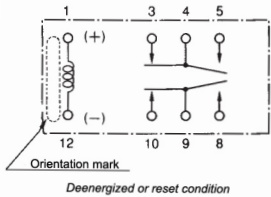

- PC board mounting hole layout (BOTTOM VIEW)

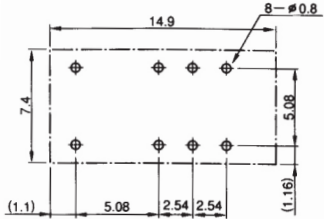

NAL-D (Double winding latching type)

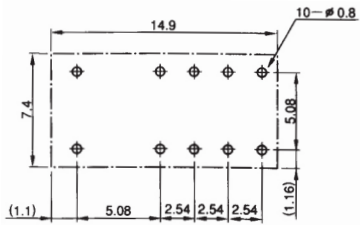
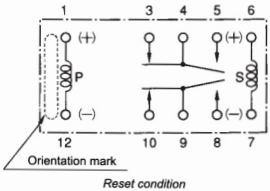
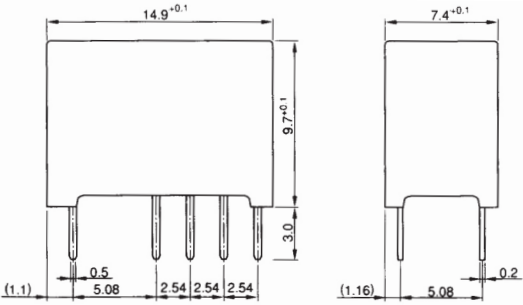

Unit: mm

## RoHS Compliance and Lead Free Information

### 1. General Information

- All signal and power relays produced by Fujitsu Components are compliant with RoHS directive 2002/95EC including amendments.
- Cadmium as used in electrical contacts is exempted from the RoHS directives on October 21st, 2005. (Amendment to Directive 2002/95/EC)
- All of our signal and power relays are lead-free. Please refer to Lead-Free Status Info for older date codes at: <http://www.fujitsu.com/us/downloads/MICRO/fcai/relays/lead-free-letter.pdf>
- Lead free solder plating on relay terminals is Sn-3.0Ag-0.5Cu, unless otherwise specified. This material has been verified to be compatible with PbSn assembly process.

### 2. Recommended Lead Free Solder Profile

- Recommended solder Sn-3.0Ag-0.5Cu.

**Flow Solder condition:**

Pre-heating: maximum 120°C  
Soldering: dip within 5 sec. at  
260°C solder bath

**Solder by Soldering Iron:**

Soldering Iron  
Temperature: maximum 360°C  
Duration: maximum 3 sec.

**We highly recommend that you confirm your actual solder conditions**

### 3. Moisture Sensitivity

- Moisture Sensitivity Level standard is not applicable to electromechanical relays, unless otherwise indicated.

### 4. Tin Whiskers

- Dipped SnAgCu solder is known as presenting a low risk to tin whisker development. No considerable length whisker was found by our in house test.



## Fujitsu Components International Headquarter Offices

### Japan

Fujitsu Component Limited  
Gotanda-Chuo Building  
3-5, Higashigotanda 2-chome, Shinagawa-ku  
Tokyo 141, Japan  
Tel: (81-3) 5449-7010  
Fax: (81-3) 5449-2626  
Email: [promothq@ft.ed.fujitsu.com](mailto:promothq@ft.ed.fujitsu.com)  
Web: [www.fcl.fujitsu.com](http://www.fcl.fujitsu.com)

### North and South America

Fujitsu Components America, Inc.  
250 E. Caribbean Drive  
Sunnyvale, CA 94089 U.S.A.  
Tel: (1-408) 745-4900  
Fax: (1-408) 745-4970  
Email: [components@us.fujitsu.com](mailto:components@us.fujitsu.com)  
Web: <http://us.fujitsu.com/components>

### Europe

Fujitsu Components Europe B.V.  
Diamantlaan 25  
2132 WV Hoofddorp  
Netherlands  
Tel: (31-23) 5560910  
Fax: (31-23) 5560950  
Email: [info@fceu.fujitsu.com](mailto:info@fceu.fujitsu.com)  
Web: [emea.fujitsu.com/components/](http://emea.fujitsu.com/components/)

### Asia Pacific

Fujitsu Components Asia Ltd.  
102E Pasir Panjang Road  
#01-01 Citilink Warehouse Complex  
Singapore 118529  
Tel: (65) 6375-8560  
Fax: (65) 6273-3021  
Email: [fcal@fcal.fujitsu.com](mailto:fcal@fcal.fujitsu.com)  
Web: <http://www.fujitsu.com/sg/services/micro/components/>

©2011 Fujitsu Components Europe B.V. All rights reserved. All trademarks or registered trademarks are the property of their respective owners.

The contents, data and information in this datasheet are provided by Fujitsu Component Ltd. as a service only to its user and only for general information purposes.

The use of the contents, data and information provided in this datasheet is at the users' own risk.

Fujitsu has assembled this datasheet with care and will endeavor to keep the contents, data and information correct, accurate, comprehensive, complete and up to date.

Fujitsu Components Europe B.V. and affiliated companies do however not accept any responsibility or liability on their behalf, nor on behalf of its employees, for any loss or damage, direct, indirect or consequential, with respect to this datasheet, its contents, data, and information and related graphics and the correctness, reliability, accuracy, comprehensiveness, usefulness, availability and completeness thereof.

Nor do Fujitsu Components Europe B.V. and affiliated companies accept on their behalf, nor on behalf of its employees, any responsibility or liability for any representation or warrant of any kind, express or implied, including warranties of any kind for merchantability or fitness for particular use, with respect to these datasheets, its contents, data, information and related graphics and the correctness, reliability, accuracy, comprehensiveness, usefulness, availability and completeness thereof. Rev. March 02, 2011

Компания «Океан Электроники» предлагает заключение долгосрочных отношений при поставках импортных электронных компонентов на взаимовыгодных условиях!

Наши преимущества:

- Поставка оригинальных импортных электронных компонентов напрямую с производств Америки, Европы и Азии, а так же с крупнейших складов мира;
- Широкая линейка поставок активных и пассивных импортных электронных компонентов (более 30 млн. наименований);
- Поставка сложных, дефицитных, либо снятых с производства позиций;
- Оперативные сроки поставки под заказ (от 5 рабочих дней);
- Экспресс доставка в любую точку России;
- Помощь Конструкторского Отдела и консультации квалифицированных инженеров;
- Техническая поддержка проекта, помощь в подборе аналогов, поставка прототипов;
- Поставка электронных компонентов под контролем ВП;
- Система менеджмента качества сертифицирована по Международному стандарту ISO 9001;
- При необходимости вся продукция военного и аэрокосмического назначения проходит испытания и сертификацию в лаборатории (по согласованию с заказчиком);
- Поставка специализированных компонентов военного и аэрокосмического уровня качества (Xilinx, Altera, Analog Devices, Intersil, Interpoint, Microsemi, Actel, Aeroflex, Peregrine, VPT, Syfer, Eurofarad, Texas Instruments, MS Kennedy, Miteq, Cobham, E2V, MA-COM, Hittite, Mini-Circuits, General Dynamics и др.);

Компания «Океан Электроники» является официальным дистрибьютором и эксклюзивным представителем в России одного из крупнейших производителей разъемов военного и аэрокосмического назначения «JONHON», а так же официальным дистрибьютором и эксклюзивным представителем в России производителя высокотехнологичных и надежных решений для передачи СВЧ сигналов «FORSTAR».



## JONHON

«JONHON» (основан в 1970 г.)

Разъемы специального, военного и аэрокосмического назначения:

(Применяются в военной, авиационной, аэрокосмической, морской, железнодорожной, горно- и нефтедобывающей отраслях промышленности)

«FORSTAR» (основан в 1998 г.)

ВЧ соединители, коаксиальные кабели,  
кабельные сборки и микроволновые компоненты:

(Применяются в телекоммуникациях гражданского и специального назначения, в средствах связи, РЛС, а так же военной, авиационной и аэрокосмической отраслях промышленности).



Телефон: 8 (812) 309-75-97 (многоканальный)

Факс: 8 (812) 320-03-32

Электронная почта: [ocean@oceanchips.ru](mailto:ocean@oceanchips.ru)

Web: <http://oceanchips.ru/>

Адрес: 198099, г. Санкт-Петербург, ул. Калинина, д. 2, корп. 4, лит. А