

Analog High Speed Coupler, High Noise Immunity, 1 MBd, 15 kV/ μ s



22644



FEATURES

- Direct replacement for HCPL 4503
- High-speed optocoupler without base connection
- Isolation test voltage: 5300 V_{RMS}
- GaAlAs emitter
- Integrated detector with photo diode and transistor
- High data transmission rate: 1 MBit/s
- TTL compatible
- Open collector output
- Good CTR linearity relative to forward current
- Field effect stable
- Low coupling capacitance
- Very high common mode transient immunity dV/dt: ≥ 15 kV/ μ s at V_{CM} = 1500 V
- Material categorization: For definitions of compliance please see www.vishay.com/doc?99912

RoHS
COMPLIANT

DESCRIPTION

The SFH6345 is an optocoupler with a GaAlAs infrared emitting diode, optically coupled to an integrated photo detector consisting of a photo diode and a high speed transistor in a DIP-8 plastic package. The device is similar to the 6N135 but has an additional faraday shield on the detector which enhances the input-output dV/dt immunity.

Signals can be transmitted between two electrically separated circuits up to frequencies of 2 MHz. This an ideal solution for industrial communication bus isolation, as well as isolated drive circuit applications such as IPM (intelligent power module) drivers.

APPLICATIONS

- Data communications
- IGBT drivers
- Programmable controllers
- IPM (intelligent power module) drivers

AGENCY APPROVALS

- UL1577, file no. E52744 system code H double protection
- DIN EN 60747-5-2 (VDE0884)/DIN EN 60747-5-5 (pending), available with option 1

ORDERING INFORMATION

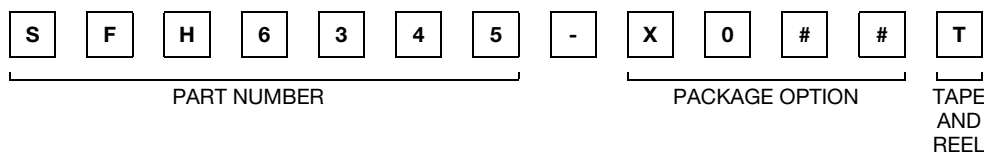

AGENCY CERTIFIED/PACKAGE	CMR (kV/ μ s)
UL	≥ 15
DIP-8	SFH6345
SMD-8, option 7	SFH6345-X007T ⁽¹⁾
SMD-8, option 9	SFH6345-X009T ⁽¹⁾
VDE, UL	
DIP-8	SFH6345-X001
DIP-8, 400 mil, option 6	SFH6345-X016
SMD-8, option 7	SFH6345-X017T ⁽¹⁾
SMD-8, option 9	SFH6345-X019T ⁽¹⁾

Note

⁽¹⁾ Also available in tubes; do not add T to end



ABSOLUTE MAXIMUM RATINGS ($T_{amb} = 25\text{ }^{\circ}\text{C}$, unless otherwise specified)				
PARAMETER	TEST CONDITION	SYMBOL	VALUE	UNIT
INPUT				
Reverse voltage		V_R	3	V
DC forward current		I_F	25	mA
Surge forward current	$t_p = 1\text{ }\mu\text{s}$, 300 pulses/s	I_{FSM}	1	A
Power dissipation		P_{diss}	45	mW
OUTPUT				
Supply voltage		V_S	- 0.5 to 30	V
Output voltage		V_O	- 0.5 to 25	V
Output current		I_O	8	mA
Power dissipation		P_{diss}	100	mW
COUPLER				
Isolation test voltage between emitter and detector		V_{ISO}	5300	V_{RMS}
Isolation resistance	$V_{IO} = 500\text{ V}$, $T_{amb} = 25\text{ }^{\circ}\text{C}$	R_{IO}	$\geq 10^{12}$	Ω
	$V_{IO} = 500\text{ V}$, $T_{amb} = 100\text{ }^{\circ}\text{C}$	R_{IO}	$\geq 10^{11}$	Ω
Storage temperature range		T_{stg}	- 55 to + 150	$^{\circ}\text{C}$
Ambient temperature range		T_{amb}	- 55 to + 125	$^{\circ}\text{C}$
Junction temperature		T_j	100	$^{\circ}\text{C}$
Soldering temperature (1)	max. 10 s, max. dip soldering: distance to seating plane $\geq 1.5\text{ mm}$	T_{sld}	260	$^{\circ}\text{C}$

Notes

- Stresses in excess of the absolute maximum ratings can cause permanent damage to the device. Functional operation of the device is not implied at these or any other conditions in excess of those given in the operational sections of this document. Exposure to absolute maximum ratings for extended periods of the time can adversely affect reliability.

(1) Refer to reflow profile for soldering conditions for surface mounted devices (SMD). Refer to wave profile for soldering conditions for through hole devices (DIP)

ELECTRICAL CHARACTERISTICS ($T_{amb} = 25\text{ }^{\circ}\text{C}$, unless otherwise specified)							
PARAMETER	TEST CONDITION	SYMBOL	MIN.	TYP.	MAX.	UNIT	
INPUT (1)							
Forward voltage	$I_F = 16\text{ mA}$	V_F		1.33	1.9	V	
Reverse current	$V_R = 3\text{ V}$	I_R		0.5	10	μA	
Capacitance	$V_R = 0\text{ V}$, $f = 1\text{ MHz}$	C_O		30		pF	
Thermal resistance		R_{thja}		700		K/W	
OUTPUT							
Supply current, logic high	$I_F = 0\text{ V}$, $V_O = \text{open}$, $V_{CC} = 15\text{ V}$	I_{CCH}		0.01	1	μA	
		I_{CCH}		0.01	2	μA	
Output current, output high	$I_F = 0\text{ V}$, $V_O = V_{CC} = 5.5\text{ V}$	I_{OH}		0.003	0.5	μA	
		I_{OH}		0.01	1	μA	
	$I_F = 0\text{ V}$, $V_O = V_{CC} = 15\text{ V}$	I_{OH}				50	μA
		I_{OH}					μA
Collector emitter capacitance	$V_{CE} = 5\text{ V}$, $f = 1\text{ MHz}$	C_{CE}		3		pF	
Thermal resistance		R_{thja}		300		K/W	
COUPLER							
Coupling capacitance		C_C		0.6		pF	
Collector emitter saturation voltage	$I_F = 16\text{ mA}$, $I_O = 2.4\text{ mA}$, $V_{CC} = 4.5\text{ V}$	V_{OL}		0.1	0.4	V	
Logic low supply current	$I_F = 16\text{ mA}$, $V_O = \text{open}$, $V_{CC} = 15\text{ V}$	I_{CCL}		80	200	μA	

Notes

- Minimum and maximum values are testing requirements. Typical values are characteristics of the device and are the result of engineering evaluation. Typical values are for information only and are not part of the testing requirements.

(1) $T_{amb} = 0\text{ }^{\circ}\text{C}$ to $70\text{ }^{\circ}\text{C}$, unless otherwise specified, typical values $T_{amb} = 25\text{ }^{\circ}\text{C}$.

CURRENT TRANSFER RATIO ($T_{amb} = 25\text{ }^{\circ}\text{C}$, unless otherwise specified)						
PARAMETER	TEST CONDITION	SYMBOL	MIN.	TYP.	MAX.	UNIT
Current transfer ratio	$I_F = 16\text{ mA}$, $V_O = 0.4\text{ V}$, $V_{CC} = 4.5\text{ V}$	I_C/I_F	19	30		%
	$I_F = 16\text{ mA}$, $V_O = 0.5\text{ V}$, $V_{CC} = 4.5\text{ V}$, $T_{amb} = 0\text{ }^{\circ}\text{C}$ to $70\text{ }^{\circ}\text{C}$	I_C/I_F	15			%

SWITCHING CHARACTERISTICS ($T_{amb} = 25\text{ }^{\circ}\text{C}$, unless otherwise specified)						
PARAMETER	TEST CONDITION	SYMBOL	MIN.	TYP.	MAX.	UNIT
Propagation delay time (high to low), see fig. 1	$I_F = 16\text{ mA}$, $V_{CC} = 5\text{ V}$, $R_L = 1.9\text{ k}\Omega$	t_{PHL}		0.3	0.8	μs
Propagation delay time (low to high), see fig. 1	$I_F = 16\text{ mA}$, $V_{CC} = 5\text{ V}$, $R_L = 1.9\text{ k}\Omega$	t_{PLH}		0.3	0.8	μs

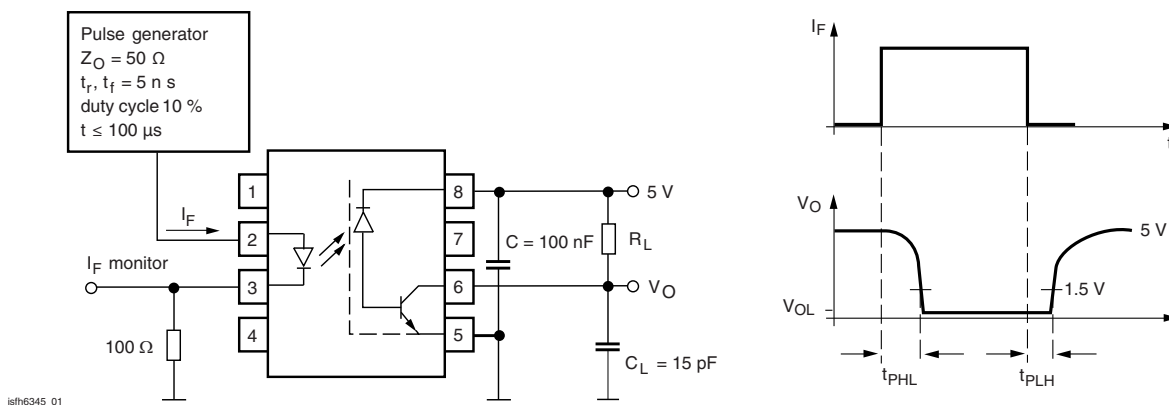

Fig. 1 - Switching Times (Typ.)

COMMON MODE TRANSIENT IMMUNITY ($T_{amb} = 25\text{ }^{\circ}\text{C}$, unless otherwise specified)						
PARAMETER	TEST CONDITION	SYMBOL	MIN.	TYP.	MAX.	UNIT
Common mode transient immunity (high), see fig. 2	$I_O = 0\text{ mA}$, $V_{CM} = 1500\text{ V}_{P-P}$, $R_L = 1.9\text{ k}\Omega$, $V_{CC} = 5\text{ V}$	$ CM_H $	15	30		$\text{kV}/\mu\text{s}$
Common mode transient immunity (low), see fig. 2	$I_O = 16\text{ mA}$, $V_{CM} = 1500\text{ V}_{P-P}$, $R_L = 1.9\text{ k}\Omega$, $V_{CC} = 5\text{ V}$	$ CM_L $	15	30		$\text{kV}/\mu\text{s}$

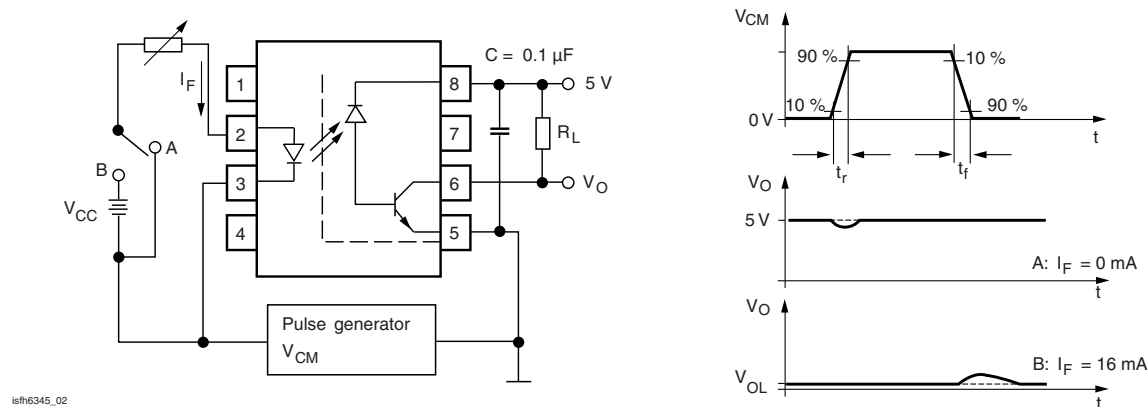

Fig. 2 - Common Mode Transient Immunity

SAFETY AND INSULATION RATINGS						
PARAMETER	TEST CONDITION	SYMBOL	MIN.	TYP.	MAX.	UNIT
Climatic classification	IEC 68 part 1			55/100/21		
Comparative tracking index		CTI	175		399	
V_{IOTM}			8000			V
V_{IORM}			890			V
P_{SO}					500	mW
I_{SI}					300	mA
T_{SI}					175	°C
Creepage distance	Standard DIP-8		7			mm
Clearance distance	Standard DIP-8		7			mm
Creepage distance	400 mil DIP-8		8			mm
Clearance distance	400 mil DIP-8		8			mm

Note

- According to DIN EN 60747-5-2 (VDE 0884), this optocoupler is suitable for “safe electrical insulation” only within the safety ratings. Compliance with the safety ratings shall be ensured by means of protective circuits.

TYPICAL CHARACTERISTICS ($T_{amb} = 25\text{ °C}$, unless otherwise specified)

Fig. 3 - LED Forward Current vs. Forward Voltage

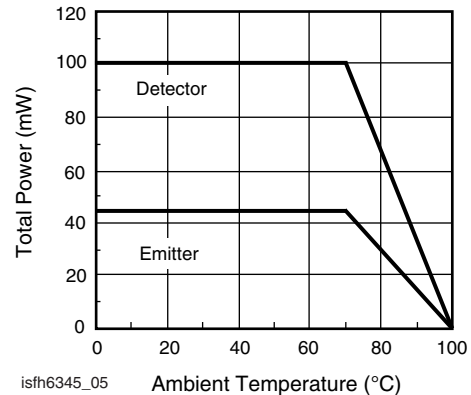

Fig. 5 - Permissible Power Dissipation vs. Temperature



Fig. 4 - Permissible Forward LED Current vs. Temperature

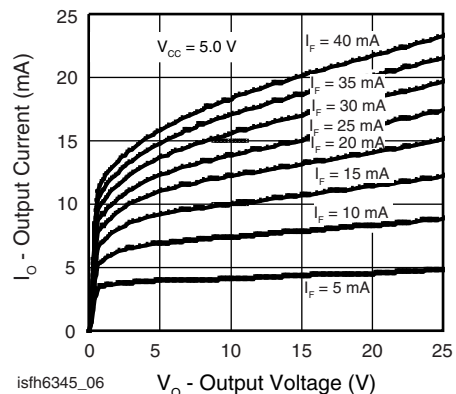

Fig. 6 - Output Current vs. Output Voltage

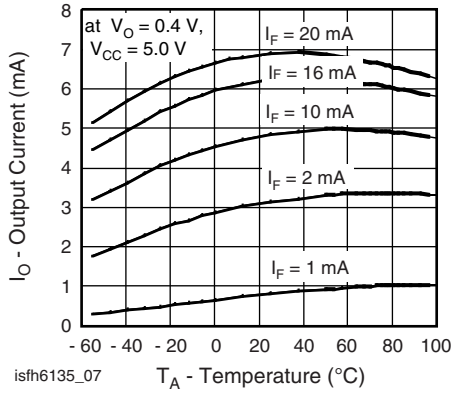

Fig. 7 - Output Current vs. Temperature

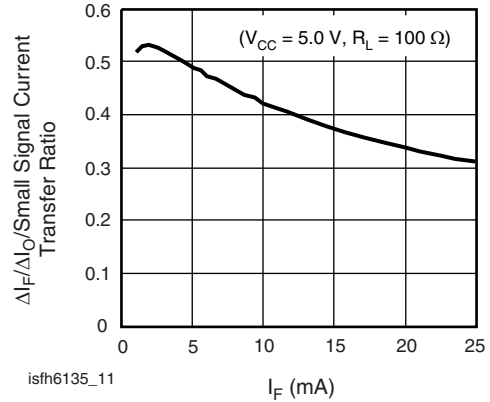

Fig. 10 - Small Signal Current Transfer Ratio vs. Input Current

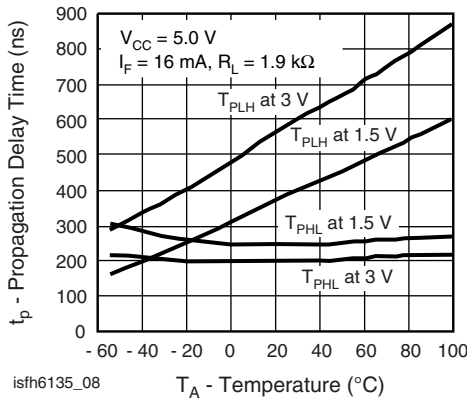

Fig. 8 - Propagation Delay vs. Ambient Temperature

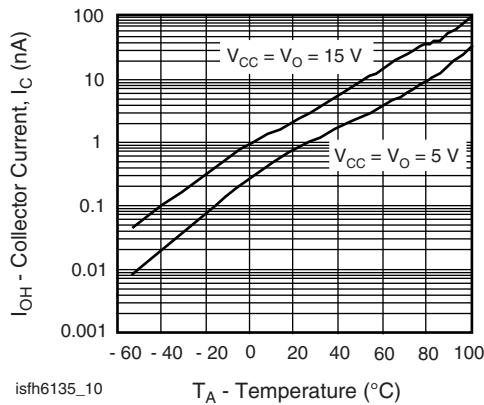
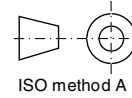
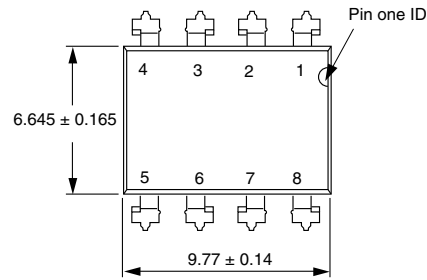

Fig. 9 - Logic High Output Current vs. Temperature



PACKAGE DIMENSIONS in millimeters



i178006

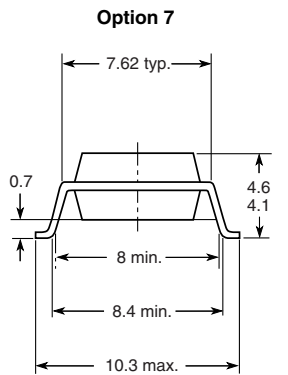

18450

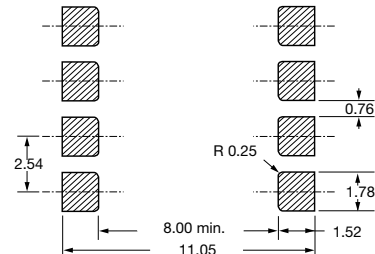
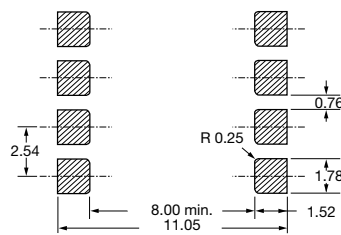

PACKAGE MARKING



Notes

- Only options 1, and 7 are reflected in the package marking.
- The VDE logo is only marked on option 1 parts.
- Tape and reel suffix (T) is not part of the package marking.



Disclaimer

ALL PRODUCT, PRODUCT SPECIFICATIONS AND DATA ARE SUBJECT TO CHANGE WITHOUT NOTICE TO IMPROVE RELIABILITY, FUNCTION OR DESIGN OR OTHERWISE.

Vishay Intertechnology, Inc., its affiliates, agents, and employees, and all persons acting on its or their behalf (collectively, "Vishay"), disclaim any and all liability for any errors, inaccuracies or incompleteness contained in any datasheet or in any other disclosure relating to any product.

Vishay makes no warranty, representation or guarantee regarding the suitability of the products for any particular purpose or the continuing production of any product. To the maximum extent permitted by applicable law, Vishay disclaims (i) any and all liability arising out of the application or use of any product, (ii) any and all liability, including without limitation special, consequential or incidental damages, and (iii) any and all implied warranties, including warranties of fitness for particular purpose, non-infringement and merchantability.

Statements regarding the suitability of products for certain types of applications are based on Vishay's knowledge of typical requirements that are often placed on Vishay products in generic applications. Such statements are not binding statements about the suitability of products for a particular application. It is the customer's responsibility to validate that a particular product with the properties described in the product specification is suitable for use in a particular application. Parameters provided in datasheets and/or specifications may vary in different applications and performance may vary over time. All operating parameters, including typical parameters, must be validated for each customer application by the customer's technical experts. Product specifications do not expand or otherwise modify Vishay's terms and conditions of purchase, including but not limited to the warranty expressed therein.

Except as expressly indicated in writing, Vishay products are not designed for use in medical, life-saving, or life-sustaining applications or for any other application in which the failure of the Vishay product could result in personal injury or death. Customers using or selling Vishay products not expressly indicated for use in such applications do so at their own risk. Please contact authorized Vishay personnel to obtain written terms and conditions regarding products designed for such applications.

No license, express or implied, by estoppel or otherwise, to any intellectual property rights is granted by this document or by any conduct of Vishay. Product names and markings noted herein may be trademarks of their respective owners.

Material Category Policy

Vishay Intertechnology, Inc. hereby certifies that all its products that are identified as RoHS-Compliant fulfill the definitions and restrictions defined under Directive 2011/65/EU of The European Parliament and of the Council of June 8, 2011 on the restriction of the use of certain hazardous substances in electrical and electronic equipment (EEE) - recast, unless otherwise specified as non-compliant.

Please note that some Vishay documentation may still make reference to RoHS Directive 2002/95/EC. We confirm that all the products identified as being compliant to Directive 2002/95/EC conform to Directive 2011/65/EU.

Vishay Intertechnology, Inc. hereby certifies that all its products that are identified as Halogen-Free follow Halogen-Free requirements as per JEDEC JS709A standards. Please note that some Vishay documentation may still make reference to the IEC 61249-2-21 definition. We confirm that all the products identified as being compliant to IEC 61249-2-21 conform to JEDEC JS709A standards.

Компания «Океан Электроники» предлагает заключение долгосрочных отношений при поставках импортных электронных компонентов на взаимовыгодных условиях!

Наши преимущества:

- Поставка оригинальных импортных электронных компонентов напрямую с производств Америки, Европы и Азии, а так же с крупнейших складов мира;
- Широкая линейка поставок активных и пассивных импортных электронных компонентов (более 30 млн. наименований);
- Поставка сложных, дефицитных, либо снятых с производства позиций;
- Оперативные сроки поставки под заказ (от 5 рабочих дней);
- Экспресс доставка в любую точку России;
- Помощь Конструкторского Отдела и консультации квалифицированных инженеров;
- Техническая поддержка проекта, помощь в подборе аналогов, поставка прототипов;
- Поставка электронных компонентов под контролем ВП;
- Система менеджмента качества сертифицирована по Международному стандарту ISO 9001;
- При необходимости вся продукция военного и аэрокосмического назначения проходит испытания и сертификацию в лаборатории (по согласованию с заказчиком);
- Поставка специализированных компонентов военного и аэрокосмического уровня качества (Xilinx, Altera, Analog Devices, Intersil, Interpoint, Microsemi, Actel, Aeroflex, Peregrine, VPT, Syfer, Eurofarad, Texas Instruments, MS Kennedy, Miteq, Cobham, E2V, MA-COM, Hittite, Mini-Circuits, General Dynamics и др.);

Компания «Океан Электроники» является официальным дистрибьютором и эксклюзивным представителем в России одного из крупнейших производителей разъемов военного и аэрокосмического назначения «**JONHON**», а так же официальным дистрибьютором и эксклюзивным представителем в России производителя высокотехнологичных и надежных решений для передачи СВЧ сигналов «**FORSTAR**».



JONHON

«**JONHON**» (основан в 1970 г.)

Разъемы специального, военного и аэрокосмического назначения:

(Применяются в военной, авиационной, аэрокосмической, морской, железнодорожной, горно- и нефтедобывающей отраслях промышленности)

«**FORSTAR**» (основан в 1998 г.)

ВЧ соединители, коаксиальные кабели, кабельные сборки и микроволновые компоненты:

(Применяются в телекоммуникациях гражданского и специального назначения, в средствах связи, РЛС, а так же военной, авиационной и аэрокосмической отраслях промышленности).



Телефон: 8 (812) 309-75-97 (многоканальный)

Факс: 8 (812) 320-03-32

Электронная почта: ocean@oceanchips.ru

Web: <http://oceanchips.ru/>

Адрес: 198099, г. Санкт-Петербург, ул. Калинина, д. 2, корп. 4, лит. А