

170A TeraDlynx™: Non-Isolated DC-DC Power Modules

7Vdc –14Vdc input; 0.6Vdc to 1.5Vdc output; 170A Output Current



RoHS Compliant

Applications

- Networking equipment
- Telecommunications equipment
- Servers and storage applications
- Distributed power architectures
- Intermediate bus voltage applications
- Industrial equipment

Features

- Compliant to RoHS EU Directive 2011/65/EU (Z versions)
- Compliant to IPC-9592 (September 2008), Category 2
- Compatible in a Pb-free or SnPb reflow environment (Z versions)
- Compliant to REACH Directive (EC) No 1907/2006
- Wide Input voltage range (7Vdc-14 Vdc)
- Output voltage programmable from 0.6Vdc to 1.5Vdc via external resistor or PMBus™# commands
- Digital interface through the PMBus protocol
- Digital sequencing
- Fast digital loop control
- Power Good signal
- Fixed switching frequency with capability of external synchronization
- Output overcurrent protection (non-latching)
- Output overvoltage protection
- Over temperature protection
- Remote On/Off
- Ability to sink and source current
- Cost efficient open frame design
- Small size: 53.8 x 31.7 x 13.3 mm [2.118" x 1.248" x 0.524"]
- Wide operating temperature range [-40°C to 85°C]
- UL* 60950-1 2nd Ed.+A1+A2 Recognized, CSA† C22.2 No. 60950-1-07+A1+A2 Certified, and VDE‡ (EN60950-1 2nd Ed.+A11+A12+A2) Licensed
- ISO** 9001 and ISO 14001 certified manufacturing facilities

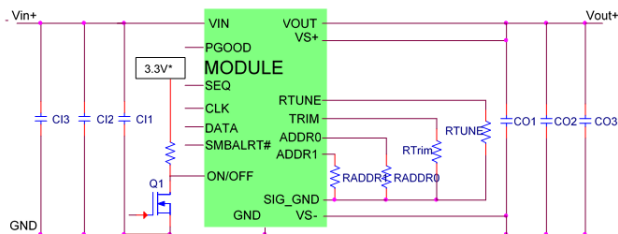

Description

The 170A Digital TeraDlynx™ power modules are non-isolated dc-dc converters that can deliver up to 170A of output current. These modules operate over a 7 to 14Vdc input range and provide a precisely regulated output voltage from 0.6 to 1.5Vdc. The output voltage is programmable via an external resistor and/or PMBus control. Features include a digital interface using the PMBus protocol, remote On/Off, adjustable output voltage, Power Good signal and overcurrent, overvoltage and overtemperature protection. The PMBus interface supports a range of commands to both control and monitor the module. The module also includes a real time compensation loop that allows optimizing the dynamic response of the converter to match the load with reduced amount of output capacitance leading to savings on cost and PWB area.

* UL is a registered trademark of Underwriters Laboratories, Inc.
 † CSA is a registered trademark of Canadian Standards Association.
 ‡ VDE is a trademark of Verband Deutscher Elektrotechniker e.V.
 ** ISO is a registered trademark of the International Organization of Standards
 # The PMBus name and logo are registered trademarks of the System Management Interface Forum (SMIF)



170A TeraDLynx™: Non-Isolated DC-DC Power Modules

7Vdc –14Vdc input; 0.6Vdc to 1.5Vdc output; 170A Output Current

Absolute Maximum Ratings

Stresses in excess of the absolute maximum ratings can cause permanent damage to the device. These are only absolute stress ratings, functional operation of the device is not implied at these or any other conditions in excess of those given in the operations sections of the technical requirements. Exposure to absolute maximum ratings for extended periods can adversely affect the device reliability.

Parameter	Device	Symbol	Min	Max	Unit
Input Voltage - Continuous	All	V_{IN}	-0.3	15	V
SEQ, ADDR0, ADDR1, RTUNE, RTRIM, SYNC, VS+, ON/OFF	All		-0.3	3.6	V
CLK, DATA, SMBALERT#	All		-0.3	3.6	V
Operating Ambient Temperature (see Thermal Considerations section)	All	T_A	-40	85	°C
Storage Temperature	All	T_{stg}	-55	125	°C

Electrical Specifications

Unless otherwise indicated, specifications apply over all operating input voltage, resistive load, and temperature conditions.

Parameter	Device	Symbol	Min	Typ	Max	Unit
Operating Input Voltage	All	V_{IN}	7	—	14	Vdc
Maximum Input Current ($V_{IN}=7V$ to $14V$, $I_O=I_{O,max}$)	All	$I_{IN,max}$			40	Adc
Input No Load Current ($V_{IN} = 12Vdc$, $I_O = 0$, module enabled)	$V_{O,set} = 0.6 Vdc$	$I_{IN,No load}$		160		mA
	$V_{O,set} = 1.5Vdc$	$I_{IN1No load}$		200		mA
Input Stand-by Current ($V_{IN} = 12Vdc$, module disabled)	All	$I_{IN,stand-by}$		62		mA
Inrush Transient	All	I^2t		1		A ² s
Input Reflected Ripple Current, peak-to-peak (5Hz to 20MHz, 1μH source impedance; $V_{IN}=0$ to $14V$, $I_O=I_{O,max}$; See Test Configurations)	All			5		mAp-p
Input Ripple Rejection (120Hz)	All			-54		dB
Output Voltage Set-point Tolerance over output voltage range from 0.5 to 1.5V	0 to 85°C	$V_{O,set}$	-0.7		+0.7	% $V_{O,set}$
	-40 to 85°C	$V_{O,set}$	-1.0		+1.0	% $V_{O,set}$
Voltage Regulation ¹						
Line Regulation	$(V_{IN}=V_{IN,min}$ to $V_{IN,max})$			2		mV
	$(12V_{IN}±20\%)$			1		mV
Load ($I_O=I_{O,min}$ to $I_{O,max}$) Regulation	All			4		mV

¹Worst case Line and load regulation data, all temperatures, from design verification testing as per IPC9592.

170A TeraDLynx™: Non-Isolated DC-DC Power Modules

7Vdc –14Vdc input; 0.6Vdc to 1.5Vdc output; 170A Output Current

Electrical Specifications (continued)

Parameter	Device	Symbol	Min	Typ	Max	Unit
Adjustment Range (selected by an external resistor)	All	V_{OUT}	0.6		1.5	Vdc
PMBus Adjustable Output Voltage Range	All	V_{OUT}	0.6		1.5	Vdc
PMBus Output Voltage Adjustment Step Size	All			61 ²		μ V
Remote Sense Range	All				0.3	Vdc
Output Ripple and Noise on nominal output ($V_{IN}=V_{IN,nom}$ and $I_o=I_{o,min}$ to $I_{o,max}$ $C_o = 1500 \mu$ F)						
Peak-to-Peak (Full bandwidth)					30	mV _{pk-pk}
RMS (Full bandwidth)	All				12	mV _{rms}
External Capacitance ³						
Minimum output capacitance	All	$C_{o,min}$	1500	—	—	μ F
Maximum output capacitance	All	$C_{o,max}$	—	—	40000	μ F
Output Current (in either sink or source mode)	All	I_o	0.005*		170	Adc
Output Current Limit Inception (Hiccup Mode) (current limit does not operate in sink mode)	All	$I_{o,lim}$		110		% $I_{o,max}$
Output Short-Circuit Current ($V_o \leq 250$ mV) (Hiccup Mode)	All	$I_{o1,s/c}, I_{o1,s/c}$		40		Arms
Efficiency	$V_{o,set} = 0.6$ Vdc	η		85.9		%
	$V_{o,set} = 0.8$ Vdc	η		88.6		%
	$V_{o,set} = 1.0$ Vdc	η		90.3		%
	$V_{o,set} = 1.2$ Vdc	η		91.4		%
	$V_{o,set} = 1.5$ Vdc	η		92.6		%
$V_{IN} = 12$ Vdc, $T_A = 25^\circ$ C $I_o = I_{o,max}, V_o = V_{o,set}$						
Switching Frequency	All	f_{sw}	-	400	-	kHz
Frequency Synchronization	All					
Synchronization Frequency Range	All		-15		+15	%
High-Level Input Voltage	All	$V_{IH,SYNC}$	2.5			V
Low-Level Input Voltage	All	$V_{IL,SYNC}$			1.1	V
Minimum Pulse Width, SYNC	All	t_{SYNC}	256			ns

* Minimum load on module should be 5mA

² this must be supported by an appropriate PMBus tool capable of writing at that resolution

³ External capacitors may require using the new Tunable Loop™ feature to ensure that the module is stable as well as getting the best transient response. See the Tunable Loop™ section for details.

170A TeraDLynx™: Non-Isolated DC-DC Power Modules

7Vdc –14Vdc input; 0.6Vdc to 1.5Vdc output; 170A Output Current

General Specifications

Parameter	Device	Min	Typ	Max	Unit
Calculated MTBF (I _o =0.8I _{o,max} , T _A =40°C) Telecordia Issue 2 Method 1 Case 3	All		11,556,226		Hours
Weight - Module with SMT Pins			57 (2.01)		g (oz.)
Module with Through Hole Pins			59 (2.08)		g (oz.)

Feature Specifications

Unless otherwise indicated, specifications apply over all operating input voltage, resistive load, and temperature conditions. See Feature Descriptions for additional information.

Parameter	Device	Symbol	Min	Typ	Max	Unit
On/Off Signal Interface (V _{IN} =V _{IN,min} to V _{IN,max} ; open collector or equivalent, Signal referenced to GND)						
Device Code with no suffix - Negative Logic (See Ordering Information) (On/OFF pin is open collector/drain logic input with external pull-up resistor; signal referenced to GND) Logic High (Module OFF) Input High Current Input High Voltage Logic Low (Module ON) Input low Current Input Low Voltage	All All All All	I _{IH} V _{IH} I _{IL} V _{IL}	— 2 — -0.2	— — — —	1 3.6* 10 0.4	mA Vdc μA Vdc
Device Code with suffix "4" - Positive Logic (See Ordering Information) (On/OFF pin is open collector/drain logic input with external pull-up resistor; signal referenced to GND) Logic High (Module ON) Input High Current Input High Voltage Logic Low (Module OFF) Input low Current Input Low Voltage	All All All All	I _{IH} V _{IH} I _{IL} V _{IL}	— 2 — -0.2	— — — —	10 3.6* 10 0.4	μA Vdc μA Vdc
Turn-On Delay and Rise Times						
(V _{IN} =V _{IN,nom} , I _o =I _{o,max} , V _o to within ±1% of steady state) Case 1: On/Off input is enabled and then input power is applied (delay from instant at which V _{IN} = V _{IN,min} until V _o = 10% of V _{o,set})	All	T _{delay}	—	30	—	ms
Case 2: Input power is applied for at least one second and then the On/Off input is enabled (delay from instant at which V _{on/Off} is enabled until V _o = 10% of V _{o,set})	All	T _{delay}	—	15	—	ms
Output voltage Rise time (time for V _o to rise from 10% of V _{o,set} to 90% of V _{o,set})	All	T _{rise}	10		—	msec
Output voltage overshoot (T _A = 25°C) V _{IN} = V _{IN,min} to V _{IN,max} , I _o = I _{o,min} to I _{o,max} With or without maximum external capacitance		Output			3.0	% V _{o,set}
Over Temperature Protection (See Thermal Considerations section)	All	T _{ref}		135		°C
PMBus Over Temperature Warning Threshold	All	T _{WARN}		125		°C

*Use external resistive voltage divider to step down higher logic voltages

170A TeraDLynx™: Non-Isolated DC-DC Power Modules

7Vdc –14Vdc input; 0.6Vdc to 1.5Vdc output; 170A Output Current

Feature Specifications (cont.)

Parameter	Device	Symbol	Min	Typ	Max	Units
Tracking Accuracy (Power-Up: 0.5V/ms) (Power-Down: 0.5V/ms) ($V_{IN, min}$ to $V_{IN, max}$; $I_{O, min}$ to $I_{O, max}$; $V_{SEQ} < V_o$)	All	$V_{SEQ} - V_o$			100	mV
	All	$V_{SEQ} - V_o$			100	mV
Input Undervoltage Lockout						
Turn-on Threshold	All				7	Vdc
Turn-off Threshold	All		6.75			Vdc
Hysteresis	All			0.25		Vdc
PMBus Adjustable Input Under Voltage Lockout Thresholds	All		7		14	Vdc
Resolution of Adjustable Input Under Voltage Threshold	All				5.8	mV
PGOOD (Power Good) for output voltages set with Rtrim**						
Signal Interface Open Drain, $V_{supply} \leq 5VDC$						
Overvoltage threshold for PGOOD ON	All			112.5		% $V_{O, set}$
Undervoltage threshold for PGOOD OFF	All			87.5		% $V_{O, set}$
Pulldown resistance of PGOOD pin	All				2	Ω
Sink current capability into PGOOD pin	All				50	mA

**If output voltage is set using VOUT COMMAND(21h) then PGOOD ON and PGOOD OFF thresholds should be manually set through PMBus commands 5E and 5F

170A TeraDlynx™: Non-Isolated DC-DC Power Modules

7Vdc –14Vdc input; 0.6Vdc to 1.5Vdc output; 170A Output Current

Digital Interface Specifications

Unless otherwise indicated, specifications apply over all operating input voltage, resistive load, and temperature conditions. See Feature Descriptions for additional information.

Parameter	Conditions	Symbol	Min	Typ	Max	Unit
PMBus Signal Interface Characteristics						
Input High Voltage (CLK, DATA)		V _{IH}	2.1			V
Input Low Voltage (CLK, DATA)		V _{IL}			1.1	V
Input high level current (CLK, DATA)		I _{IH}			0.5	μA
Input low level current (CLK, DATA)		I _{IL}			4	mA
Output Low Voltage (CLK, DATA, SMBALERT#)	I _{OUT} =4mA	V _{OL}			0.25	V
Output high level open drain leakage current (DATA, SMBALERT#)	V _{OUT} =3.6V	I _{OH}	5		55	nA
Pin capacitance		C _O			10	pF
PMBus Operating frequency range	Slave Mode	F _{PMB}	10		1000	kHz
Data hold time		t _{HD:DAT}		0		ns
Data setup time		t _{SU:DAT}		100		ns
Measurement System Characteristics						
Read delay time		t _{DLY}		110		μs
Output current measurement range		I _{IRNG}	0		185	A
Output current measurement resolution		I _{RES}		250		mA
Output current measurement accuracy	-40°C to +85°C	I _{ACC}			±5	% of I _{O,max}
V _{OUT} measurement range		V _{OUT}	0		2.0	V
V _{OUT} measurement accuracy		V _{OUT(gain)}		±1		% of V _{O,max}
V _{OUT} measurement resolution		V _{OUT(res)}		0.61		mV
V _{IN} measurement range		V _{IN}	0		16	V
V _{IN} measurement accuracy		V _{IN(gain)}		±2		%
V _{IN} measurement resolution		V _{IN(res)}		5.8		mV
Temperature measurement range		T _{MEAS}	-25		150	°C
Temperature measurement accuracy		T _{MEAS(gain)}	-8		8	°C
Temperature measurement resolution		T _{MEAS(res)}		0.08		°C

170A TeraDlynx™: Non-Isolated DC-DC Power Modules

7Vdc –14Vdc input; 0.6Vdc to 1.5Vdc output; 170A Output Current

Characteristic Curves

The following figures provide typical characteristics for the 170A Digital TeraDlynx™ at 0.6V_o and 25°C.

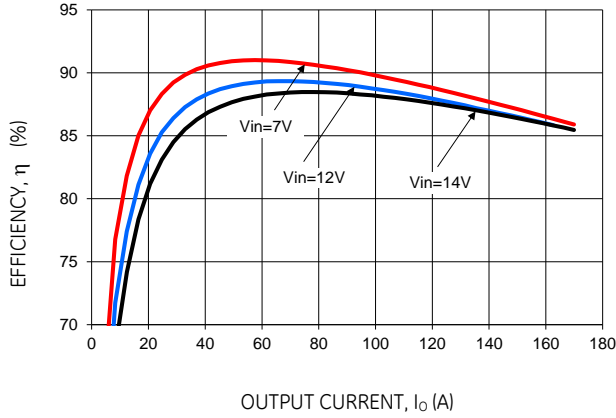

Figure 1. Converter Efficiency versus Output Current.

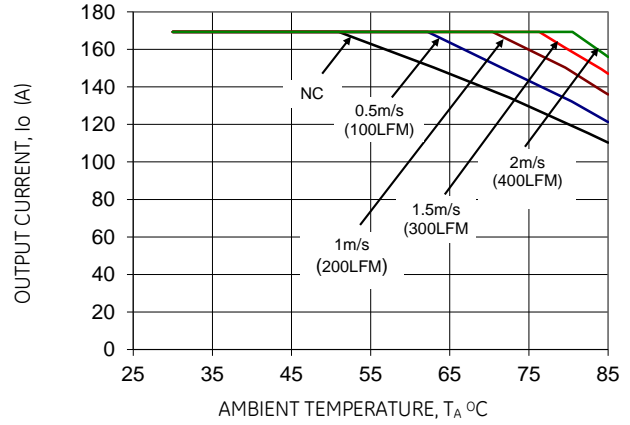

Figure 2. Derating Output Current versus Ambient Temperature and Airflow.

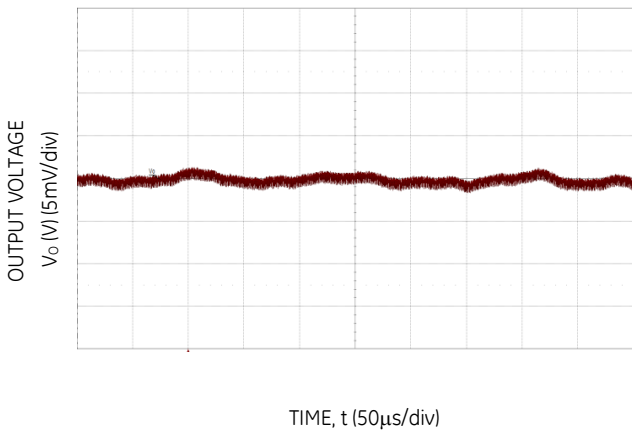

Figure 3. Typical output ripple and noise (C_o=12x47µF ceramic + 10x470µF polymer, V_{IN} = 12V, I_o = I_{o,max}).

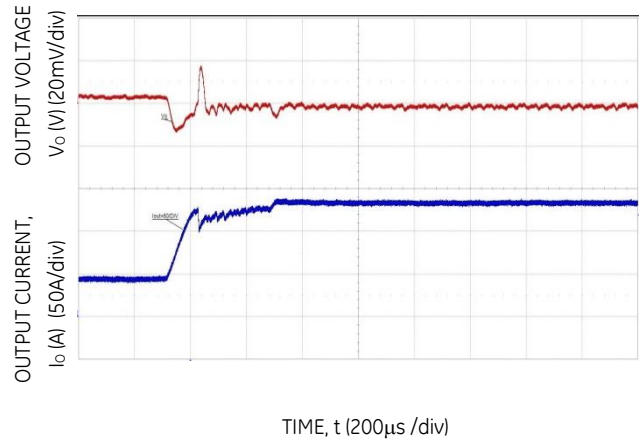

Figure 4. Transient Response to Dynamic Load Change from 25% to 75% at 12V_{in}, C_o = 12 x 47µF + 10 x 1000µF, R_{TUNE} = 3.01kΩ.

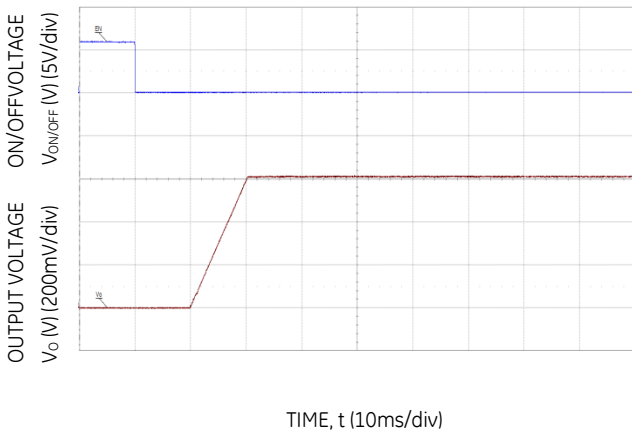

Figure 5. Typical Start-up Using On/Off Voltage (I_o = I_{o,max}).

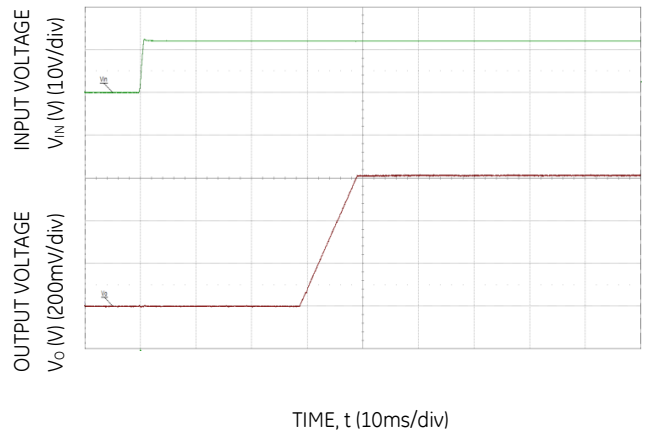

Figure 6. Typical Start-up Using Input Voltage (V_{IN} = 12V, I_o = I_{o,max}).

170A TeraDLynx™: Non-Isolated DC-DC Power Modules

7Vdc –14Vdc input; 0.6Vdc to 1.5Vdc output; 170A Output Current

Characteristic Curves

The following figures provide typical characteristics for the 170A TeraDLynx™ at 0.8Vo and 25°C

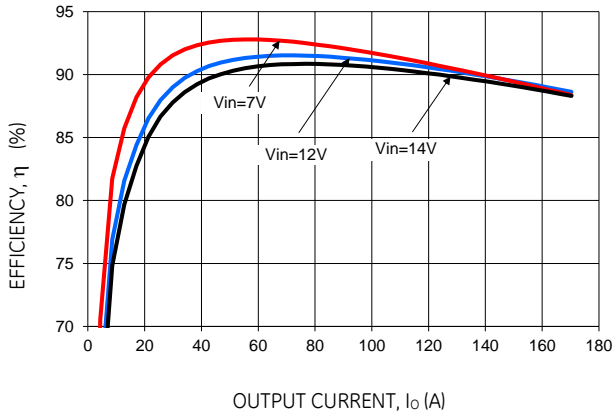

Figure 7. Converter Efficiency versus Output Current.

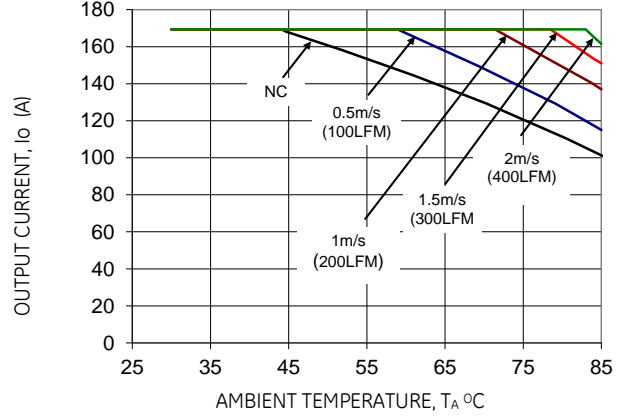

Figure 8. Derating Output Current versus Ambient Temperature and Airflow.

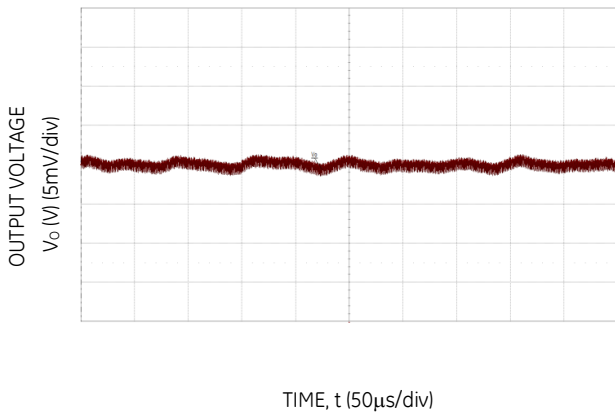

Figure 9. Typical output ripple and noise (Co=12x47µF ceramic + 10x470µF polymer, VIN = 12V, Io = Io,max.)

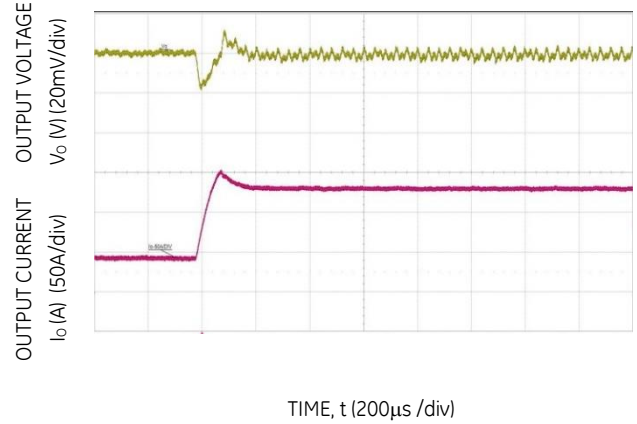

Figure 10. Transient Response to Dynamic Load Change from 25% to 75% at 12Vin, Co = 12 x 47µF + 10 x 1000µF, RTUNE = 3.01kΩ.

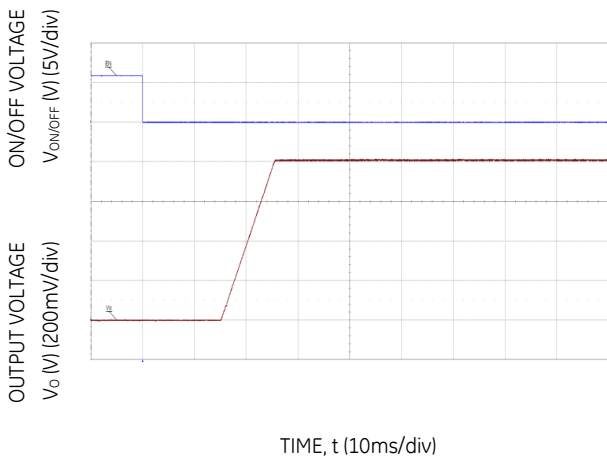

Figure 11. Typical Start-up Using On/Off Voltage (Io = Io,max).

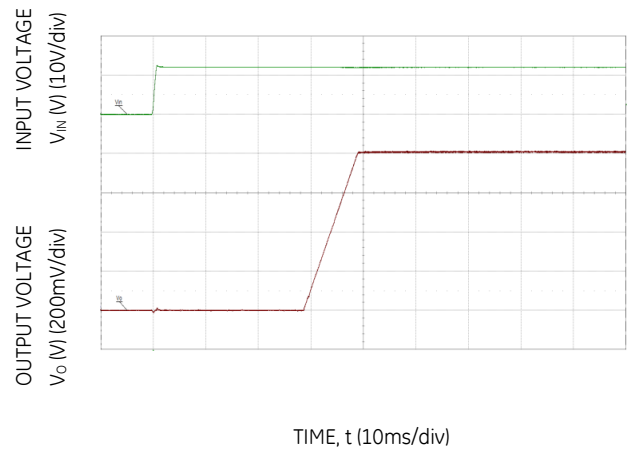

Figure 12. Typical Start-up Using Input Voltage (VIN = 12V, Io = Io,max).

170A TeraDlynx™: Non-Isolated DC-DC Power Modules

7Vdc –14Vdc input; 0.6Vdc to 1.5Vdc output; 170A Output Current

Characteristic Curves

The following figures provide typical characteristics for the 170A Digital TeraDlynx™ at 1.0Vo and 25°C.

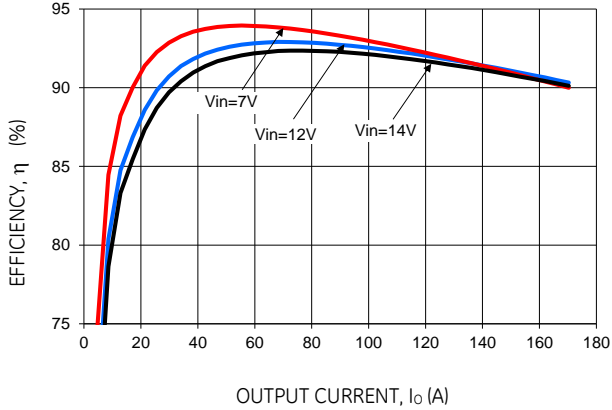

Figure 13. Converter Efficiency versus Output Current.

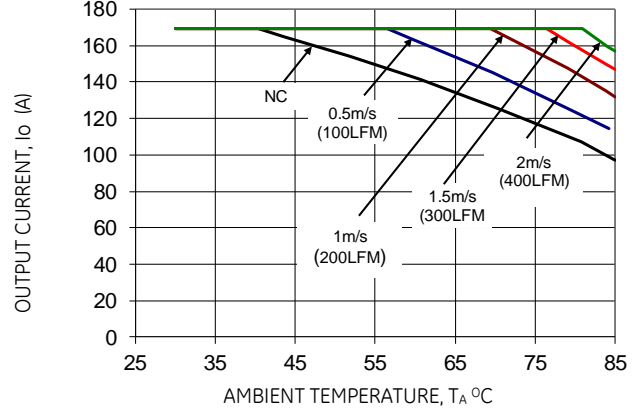

Figure 14. Derating Output Current versus Ambient Temperature and Airflow.

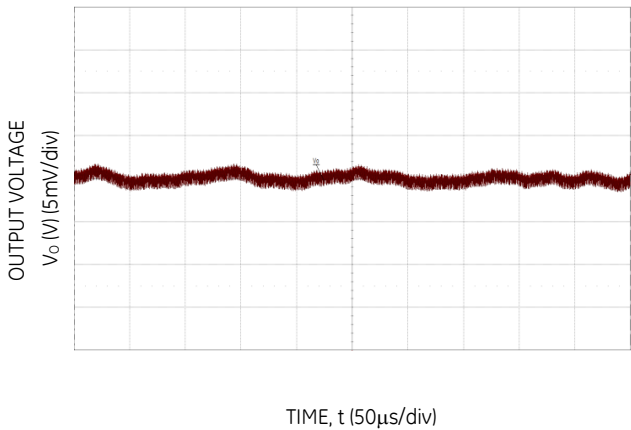

Figure 15. Typical output ripple and noise (Co=12x47µF ceramic + 10x470µF polymer, VIN = 12V, Io = Io,max.)

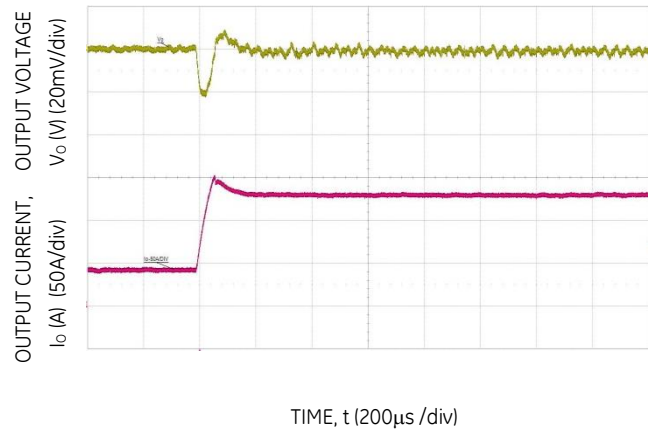

Figure 16. Transient Response to Dynamic Load Change from 25% to 75% at 12Vin, Co= 12 x 47µF + 10 x 1000µF, RTUNE = 3.01kΩ.

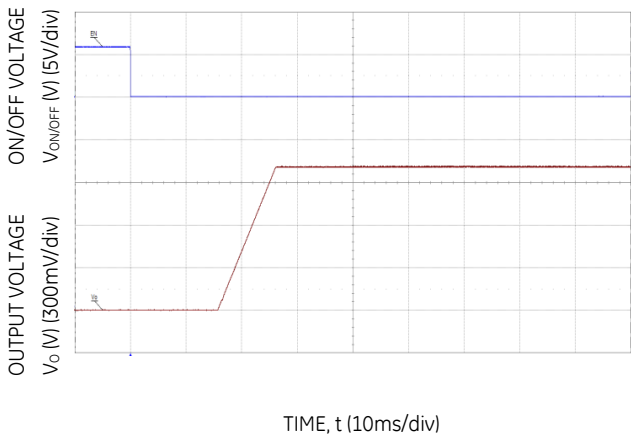

Figure 17. Typical Start-up Using On/Off Voltage (Io = Io,max).

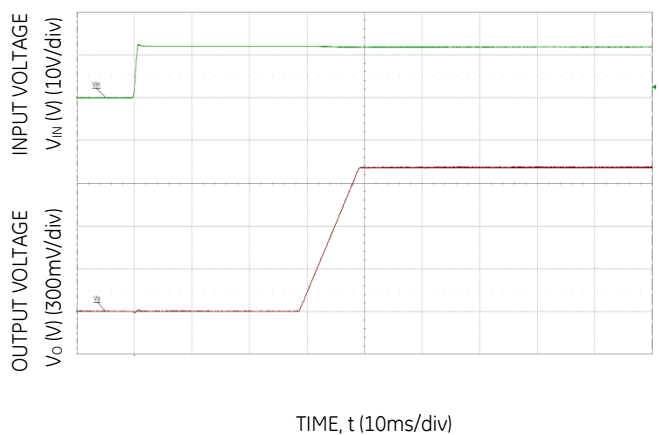

Figure 18. Typical Start-up Using Input Voltage (VIN = 12V, Io = Io,max).

170A TeraDlynx™: Non-Isolated DC-DC Power Modules

7Vdc –14Vdc input; 0.6Vdc to 1.5Vdc output; 170A Output Current

Characteristic Curves

The following figures provide typical characteristics for the 170A Digital TeraDlynx™ at 1.2V_o and 25°C.

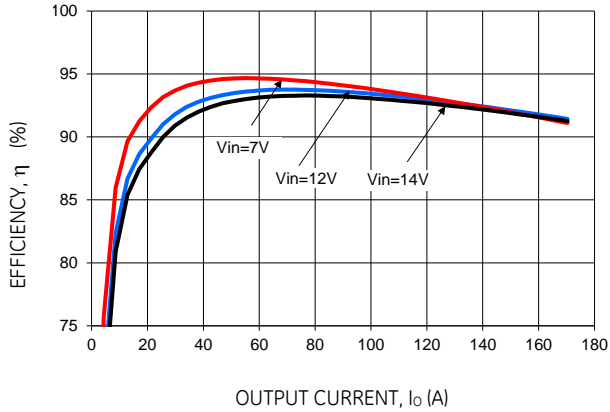

Figure 19. Converter Efficiency versus Output Current.

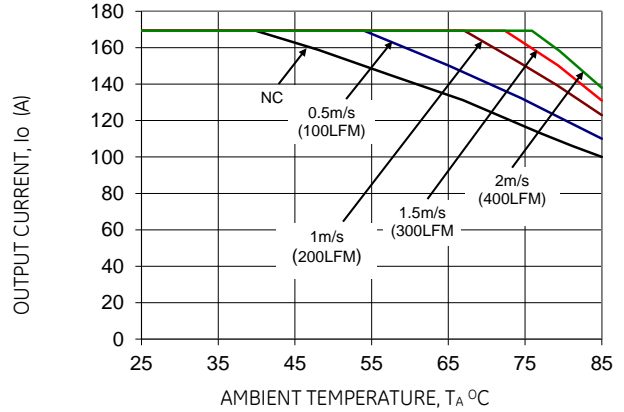

Figure 20. Derating Output Current versus Ambient Temperature and Airflow.

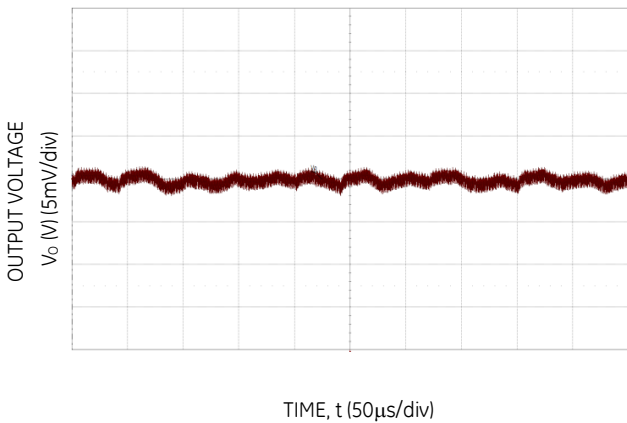

Figure 21. Typical output ripple and noise (C_o=12x47µF ceramic + 10x470µF polymer, V_{IN} = 12V, I_o = I_{o,max})

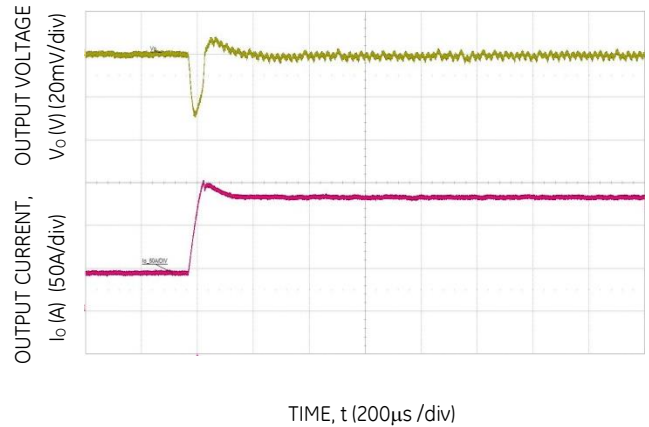

Figure 22. Transient Response to Dynamic Load Change from 25% to 75% at 12Vin, C_o = 12 x 47µF + 10 x 1000µF, R_{TUNE} = 3.01kΩ.

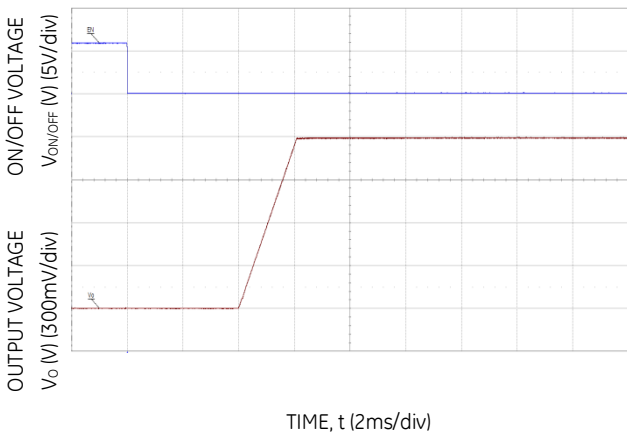

Figure 23. Typical Start-up Using On/Off Voltage (I_o = I_{o,max}).

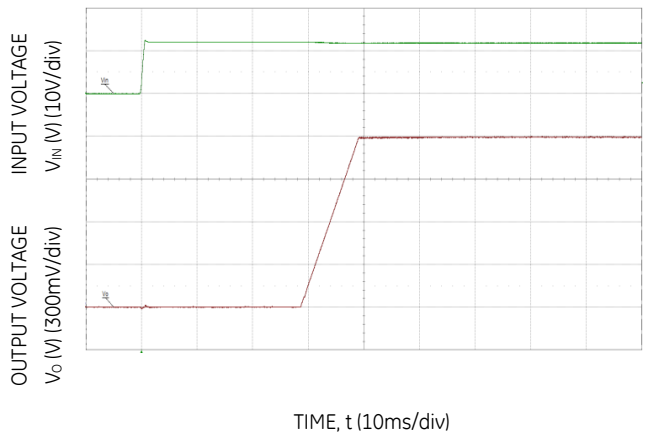

Figure 24. Typical Start-up Using Input Voltage (V_{IN} = 12V, I_o = I_{o,max}).

170A TeraDlynx™: Non-Isolated DC-DC Power Modules

7Vdc –14Vdc input; 0.6Vdc to 1.5Vdc output; 170A Output Current

Characteristic Curves

The following figures provide typical characteristics for the 170A Digital TeraDlynx™ at 1.5Vo and 25°C.

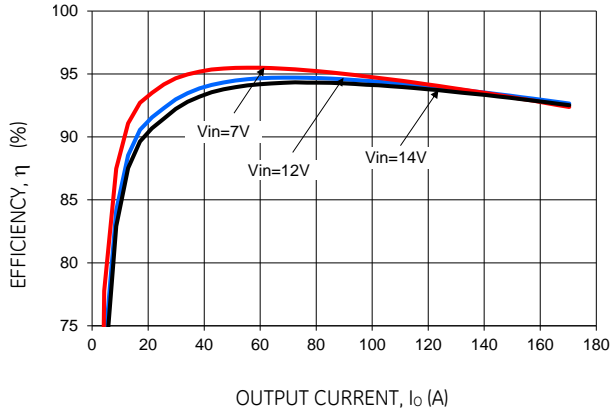

Figure 25. Converter Efficiency versus Output Current.

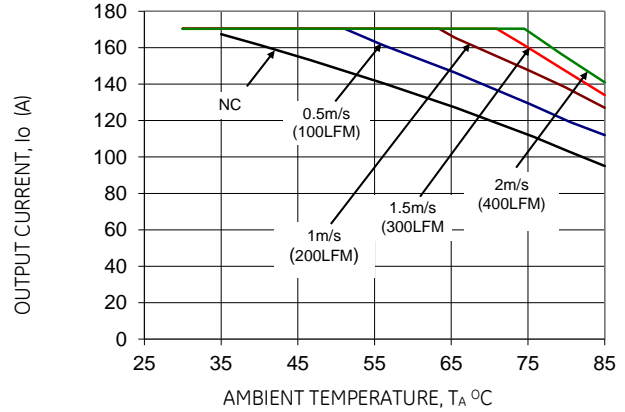

Figure 26. Derating Output Current versus Ambient Temperature and Airflow.

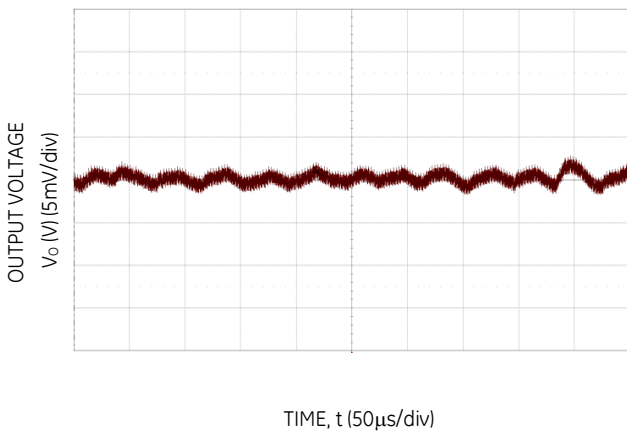

Figure 27. Typical output ripple and noise ($C_o=12 \times 47\mu\text{F}$ ceramic + $10 \times 470\mu\text{F}$ polymer, $V_{IN} = 12\text{V}$, $I_o = I_{o,max}$)

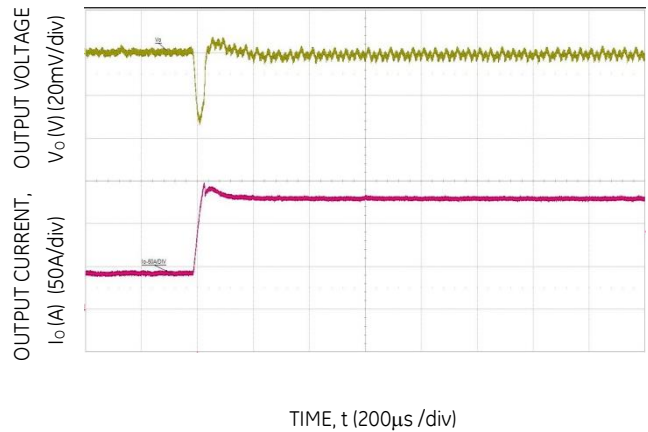

Figure 28. Transient Response to Dynamic Load Change from 25% to 75% at 12Vin, $C_o = 12 \times 47\mu\text{F} + 10 \times 1000\mu\text{F}$, $R_{TUNE} = 3.01\text{k}\Omega$.

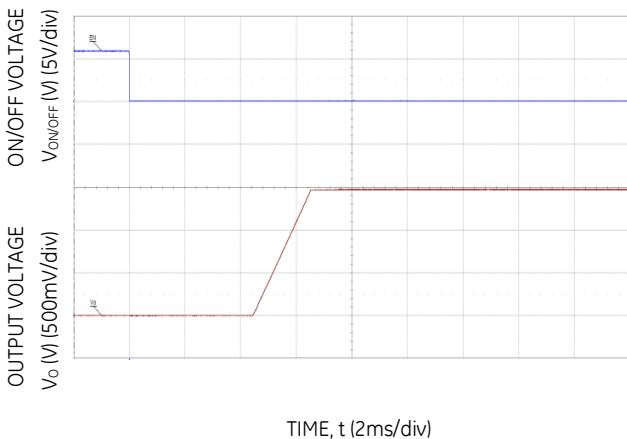

Figure 29. Typical Start-up Using On/Off Voltage ($I_o = I_{o,max}$).

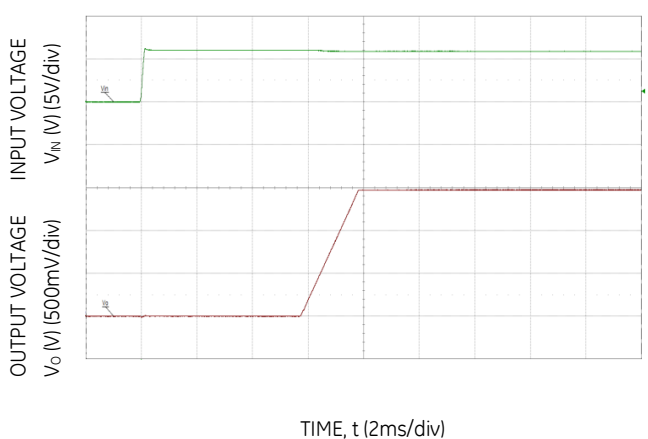

Figure 30. Typical Start-up Using Input Voltage ($V_{IN} = 12\text{V}$, $I_o = I_{o,max}$).

170A TeraDlynx™: Non-Isolated DC-DC Power Modules

7Vdc –14Vdc input; 0.6Vdc to 1.5Vdc output; 170A Output Current

Design Considerations

Input Filtering

The 170A TeraDlynx™ module should be connected to a low ac-impedance source. A highly inductive source can affect the stability of the module. An input capacitance must be placed directly adjacent to the input pins of the module, to minimize input ripple voltage and ensure module stability.

To minimize input voltage ripple, ceramic capacitors are recommended at the input of the module. Figure 31 shows the input ripple voltage for various output voltages at 170A of load current with 4x470 + 12x22 + 12x4.7 μF and 2x470 + 6x22 + 12x4.7 μF input capacitor combinations.

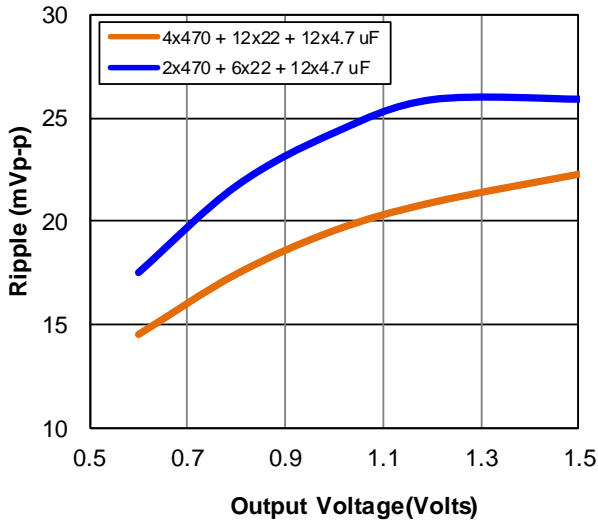

Figure 31. Input ripple voltage for various output voltages with two input capacitor combinations at 170A load. Input voltage is 12V.

Output Filtering

These modules are designed for low output ripple voltage and will meet the maximum output ripple specification with minimum of 12 x 22 μF ceramic capacitors at the output of the module. However, additional output filtering may be required by the system designer for a number of reasons. First, there may be a need to further reduce the output ripple and noise of the module. Second, the dynamic response characteristics may need to be customized to a particular load step change.

To reduce the output ripple and improve the dynamic response to a step load change, additional capacitance at the output can be used. Low ESR polymer and ceramic capacitors are recommended to improve the dynamic response of the module. Figure 32 provides output ripple information for capacitance of ~3574μF (47μF (1210 ceramic) x 12 + 10μF (0805 ceramic) + 0.1uF (0402) x4 + 1000μF (polymer) x 3) at various Vo and a full load current of 170A. For stable operation of the module, limit the capacitance to less than the maximum output capacitance as specified in the electrical specification table. Optimal

performance of the module can be achieved by using the Tunable Loop™ feature described later in this data sheet.

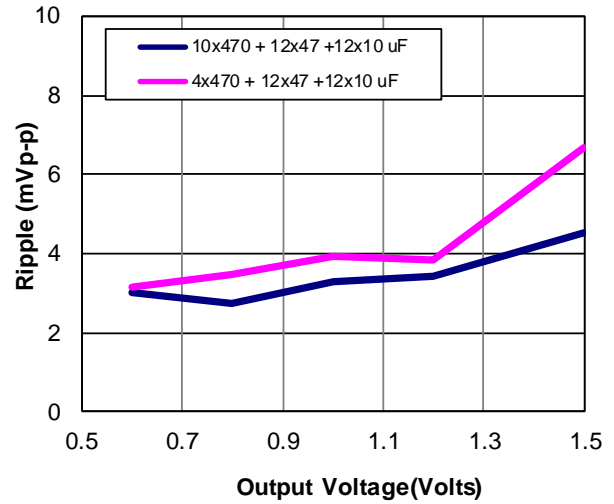

Figure 32. Peak to peak output ripple voltage for various output voltages with external capacitors at the output (170A load). Input voltage is 12V.

Input (Vin/GND) and Output (Vout/GND) Power Pins

Vin, Vout and GND power pins must ALL be used in connection to their respective application layout/circuitry to ensure optimum electrical and thermal operation of the high-power module.

Safety Considerations

For safety agency approval the power module must be installed in compliance with the spacing and separation requirements of the end-use safety agency standards, i.e., ANSI/UL 60950-1 2nd Revised October 14, 2014, CSA C22.2 No. 60950-1-07, Second Ed. + A2:2014 (MOD), DIN EN 60950-1:2006 + A11:2009 + A1:2010 +A12:2011, + A2:2013 (VDE0805 Teil 1: 2014-08)(pending).

For the converter output to be considered meeting the requirements of safety extra-low voltage (SELV), the input must meet SELV requirements. The power module has extra-low voltage (ELV) outputs when all inputs are ELV.

The input to these units is to be provided with a slow-blow fuse. When the input voltage is ≤ 8V, the recommendation is to use two 25A Littelfuse 456 series or equivalent fuses in parallel. For input voltages > 8V, a single 40A Littelfuse series 456 or equivalent fuse is recommended.

170A TeraDlynx™: Non-Isolated DC-DC Power Modules

7Vdc –14Vdc input; 0.6Vdc to 1.5Vdc output; 170A Output Current

Analog Feature Descriptions

Remote On/Off

The TeraDlynx 170A module can be turned ON and OFF either by using the ON/OFF pin (Analog interface) or through the PMBus interface (Digital). The module can be configured in a number of ways through the PMBus interface to react to the ON/OFF input:

- Module ON/OFF can controlled only through the analog interface (digital interface ON/OFF commands are ignored)
- Module ON/OFF can controlled only through the PMBus interface (analog interface is ignored)
- Module ON/OFF can be controlled by either the analog or digital interface

The default state of the module (as shipped from the factory) is to be controlled by the analog interface only. If the digital interface is to be enabled, or the module is to be controlled only through the digital interface, this change must be made through the PMBus. These changes can be made and written to non-volatile memory on the module so that it is remembered for subsequent use.

Analog On/Off

The 170A Digital TeraDlynx™ power modules feature an On/Off pin for remote On/Off operation. With the Negative Logic On/Off option, (see Ordering Information), the module turns OFF during logic High and ON during logic Low. The On/Off signal should be always referenced to ground. Leaving the On/Off pin disconnected will turn the module ON when input voltage is present. With the positive logic on/off option, the module turns ON during logic high and OFF during logic low.

Digital On/Off

Please see the Digital Feature Descriptions section.

Monotonic Start-up and Shutdown

The module has monotonic start-up and shutdown behavior on the output for any combination of rated input voltage, output current and operating temperature range.

Startup into Pre-biased Output

The module will start into a pre biased output on output as long as the pre bias voltage is 0.5V less than the set output voltage.

Analog Output Voltage Programming

The output voltage of the module is programmable to any voltage from 0.6 to 1.5Vdc, as shown in Table 1, by connecting a resistor between the Trim and SIG_GND pins of the module as shown in Fig 33.

Without an external resistor between the Trim pin and SIG_GND pins, the output of the module will be 0.1 Vdc. The value of the trim resistor, R_{trim} for a desired output voltage, should be selected as shown in Table 1.

The trim resistor is only determined during module initialization and hence cannot be used for dynamic output voltage adjustment

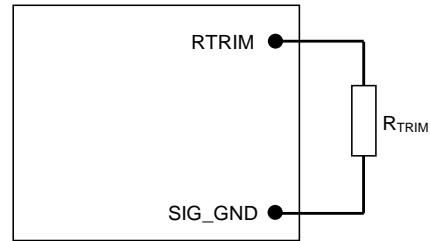

Figure 33. Circuit configuration for programming output voltage using an external resistor.

Table 1

$V_{O, set}$ (V)	Rtrim (Ω)	$V_{O, set}$ (V)	Rtrim (Ω)	$V_{O, set}$ (V)	Rtrim (Ω)
0.600	1090	1.000	2870	1.400	18900
0.620	1140	1.020	3050	1.420	23200
0.640	1180	1.040	3240	1.440	29800
0.660	1230	1.060	3480	1.460	40200
0.680	1290	1.080	3700	1.480	60400
0.700	1330	1.100	3920	1.500	115000
0.720	1380	1.120	4220		
0.740	1470	1.140	4530		
0.760	1560	1.160	4990		
0.780	1640	1.180	5360		
0.800	1740	1.200	5900		
0.820	1820	1.220	6420		
0.840	1930	1.240	6980		
0.860	2030	1.260	7680		
0.880	2130	1.280	8450		
0.900	2230	1.300	9420		
0.920	2340	1.320	10400		
0.940	2460	1.340	11700		
0.960	2610	1.360	13500		
0.980	2710	1.380	15800		

Digital Output Voltage Adjustment

Please see the Digital Feature Descriptions section.

Remote Sense

The power module has a differential Remote Sense feature to minimize the effects of distribution losses by regulating the voltage between the sense pins (VS+ and VS-) for the output. The voltage drop between the sense pins and the VOUT and GND pins of the module should not exceed 0.3V.

Digital Output Voltage Margining

Please see the Digital Feature Descriptions section.

170A TeraDLynx™: Non-Isolated DC-DC Power Modules

7Vdc –14Vdc input; 0.6Vdc to 1.5Vdc output; 170A Output Current

Output Voltage Sequencing

The power module includes a sequencing feature, EZ-SEQUENCE that enables users to implement various types of output voltage sequencing in their applications. This is accomplished via an additional sequencing pin. When not using the sequencing feature, leave it unconnected.

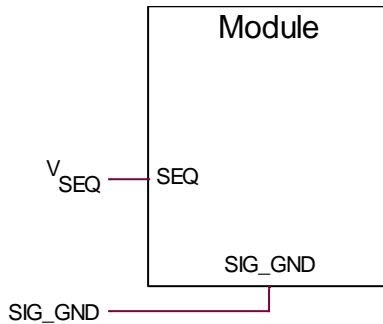

Figure 34. Circuit showing connection of the sequencing signal to the SEQ pin.

When the sequencing voltage is applied to the SEQ pin, the output voltage tracks this voltage until the output reaches the set-point voltage. The final value of the sequencing voltage must be set higher than the set-point voltage of the module. The output voltage follows the sequencing voltage on a one-to-one basis. By connecting multiple modules together, multiple modules can track their output voltages to the voltage applied on the SEQ pin.

The module's output can track the SEQ pin signal with slopes of up to 0.5V/msec during power-up or power-down. To initiate simultaneous shutdown of the modules, the SEQ pin voltage is lowered in a controlled manner. The output voltage of the modules tracks the voltages below their set-point voltages on a one-to-one basis. A valid input voltage must be maintained until the tracking and output voltages reach ground potential.

Digital Sequencing

The module can support digital sequencing by allowing control of the turn-on delay and rise times as well as turn-off and fall times,

Digital Output Voltage Margining

Please see the Digital Feature Descriptions section.

Overcurrent Protection (OCP)

To provide protection in a fault (output overload) condition, the unit is equipped with internal current-limiting circuitry on output and can endure current limiting continuously. The module overcurrent response is non-latching shutdown with automatic recovery. OCP response time is programmable through manufacturer specific commands. The unit operates normally once the output current is brought back into its specified range.

Digital Adjustable Overcurrent Warning

Please see the Digital Feature Descriptions section.

Overtemperature Protection

To provide protection in a fault condition, the unit is equipped with a thermal shutdown circuit. The unit will shut down if the overtemperature threshold of 135 °C (typ) is exceeded at the thermal reference point T_{ref} . Once the unit goes into thermal shutdown it will then wait to cool before attempting to restart.

Digital Adjustable Overcurrent Warning/Shutdown

Please see the Digital Feature Descriptions section.

Digital Temperature Status via PMBus

Please see the Digital Feature Descriptions section.

Digitally Adjustable Output Over and Under Voltage Protection

Please see the Digital Feature Descriptions section.

Input Undervoltage Lockout

At input voltages below the input undervoltage lockout limit, module operation for the associated output is disabled. The module will begin to operate at an input voltage above the undervoltage lockout turn-on threshold.

Digitally Adjustable Input Undervoltage Lockout

Please see the Digital Feature Descriptions section.

Digitally Adjustable Power Good Thresholds

Please see the Digital Feature Descriptions section.

Synchronization

The module switching frequency is capable of being synchronized to an external signal frequency within a specified range. Synchronization is done by using the external signal applied to the SYNC pin of the module as shown in Fig. 35, with the converter being synchronized by the rising edge of the external signal. The Electrical Specifications table specifies the requirements of the external SYNC signal. If the SYNC pin is not used, the module should free run at the default switching frequency.

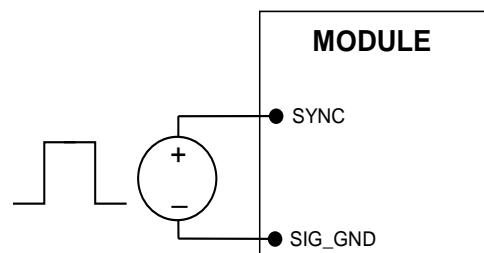

Figure 35. External source connections to synchronize switching frequency of the module.

Measuring Output Current, Output Voltage and Input Voltage

Please see the Digital Feature Descriptions section.

Digital Compensator

The TJT170 module uses digital control to regulate the output voltage. As with all POL modules, external capacitors

170A TeraDLynx™: Non-Isolated DC-DC Power Modules

7Vdc –14Vdc input; 0.6Vdc to 1.5Vdc output; 170A Output Current

are usually added to the output of the module for two reasons: to reduce output ripple and noise and to reduce output voltage deviations from the steady-state value in the presence of dynamic load current changes. Adding external capacitance however affects the voltage control loop of the module, typically causing the loop to slow down with sluggish response. Larger values of external capacitance could also cause the module to become unstable.

The TJT170 comes with default compensation values programmed into the non-volatile memory of the module. These digital compensation values can be adjusted externally to optimize transient response and also ensure stability for a wide range of external capacitance, as well as with different types of output capacitance. This can be done by two different methods.

1. By allowing the user to select among several pre-tuned compensation choices to select the one most suited to the transient response needs of the load. This selection is made via a resistor R_{TUNE} connected between the $RTUNE$ and SIG_GND pins as shown in Fig. 35. Table 2 shows various pre-tuned compensation combinations recommended for various external capacitor combinations.
2. Using PMBus to change compensation parameters in the module.

Note that during initial startup of the module, compensation values that are stored in non-volatile memory are used. If a resistor R_{TUNE} is connected to the module, then the compensation values are changed to ones that correspond to the value of R_{TUNE} . If $RTUNE$ is open however, no change in compensation values is made. Finally, if the user chooses to do so, they can overwrite the compensation values via PMBus commands.

Recommended values of R_{TUNE} for different output capacitor combinations are given in Table 2. If no $RTUNE$ is used, the default compensation values are used.

The TJT170 pre-tuned compensation can be divided into three different banks (COMP1, COMP2, COMP3) that are available to the user to compensate the control loop for various values and combinations of output capacitance and to obtain reliable and stable performance under different conditions. Each bank consists of 20 different sets of compensation coefficients pre-calculated for different values of output capacitance. The three banks are set up as follows:

- COMP1: Recommended for the case where all of the output capacitance is composed of only ceramic capacitors. The range of external output capacitance is from 1470 μF to a maximum value of 17640 μF

- COMP2: For the most commonly used mix of ceramic and polymer type capacitors that have higher output capacitance in a smaller size. The range of output capacitance is from 2564 μF to a maximum of 30564 μF . This is the combination of output capacitance and compensation that can achieve the best transient response at lowest cost and smallest size. For example, with the maximum output capacitance of $12 \times 47\mu F$ ceramics + $25 \times 1000 \mu F$ polymer capacitors, and selecting $RTUNE = 5.36k\Omega$, transient deviation can be as low as 25 mV, for a 50% load step (0 to 85A).
- COMP3: Suitable for a mix of ceramic and higher ESR polymers or electrolytic capacitors, with output capacitance ranging from a minimum of 2204 μF to a maximum of 30084 μF .

Selecting R_{TUNE} according to Table 2 will ensure stable operation of the module with sufficient stability margin as well as yield optimal transient response. Also, see section on Power Module Wizard after Table 2.

In applications with tight output voltage limits in the presence of dynamic current loading, additional output capacitance will be required. Table 3 lists recommended values of R_{TUNE} in order to meet 2% output voltage deviation limits for some common output voltages in the presence of an 85A to 170A step change (50% of full load), with an input voltage of 12V. Please contact your GE technical representative to obtain more details of this feature as well as for guidelines on how to select the right value of external $RTUNE$ to tune the module for best transient performance and stable operation for other output capacitance values. Simulation models are also available via the GE Power Module Wizard to predict stability characteristics and transient response.

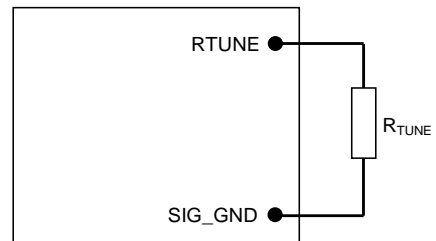

Figure 36. Circuit diagram showing connection of R_{TUNE} to tune the control loop of the module.

170A TeraDlynx™: Non-Isolated DC-DC Power Modules

7Vdc –14Vdc input; 0.6Vdc to 1.5Vdc output; 170A Output Current

Table 2. Recommended R_{TUNE} Compensation.

Output Capacitance Type	Number of Output Capacitors**	Total Output Capacitance (μF)**	R _{TUNE} resistor (Ω)	R _{TUNE} Index	KD	KI	KP	AP
Default Compensation Values			OPEN		375	2	37	150
Ceramic	10 × 47μF + 10 × 100μF	1398	29.1	0	375	2	37	150
Ceramic	12 × 47μF + 12 × 100μF	1644	88.7	1	441	3	44	150
Ceramic	14 × 47μF + 14 × 100μF	1890	150	2	506	3	51	150
Ceramic	16 × 47μF + 16 × 100μF	2136	213	3	572	3	57	150
Ceramic	19 × 47μF + 19 × 100μF	2505	280	4	671	3	67	150
Ceramic	22 × 47μF + 22 × 100μF	2874	348	5	770	4	77	150
Ceramic	25 × 47μF + 25 × 100μF	3243	417	6	869	4	87	150
Ceramic	28 × 47μF + 28 × 100μF	3612	493	7	968	4	97	150
Ceramic	31 × 47μF + 31 × 100μF	3981	569	8	1067	4	107	150
Ceramic	34 × 47μF + 34 × 100μF	4350	642	9	1166	4	117	150
Ceramic	38 × 47μF + 38 × 100μF	4842	723	10	1297	5	130	150
Ceramic	42 × 47μF + 42 × 100μF	5334	806	11	1429	5	143	150
Ceramic	48 × 47μF + 48 × 100μF	6072	898	12	1627	5	163	150
Ceramic	55 × 47μF + 55 × 100μF	6933	938	13	1858	5	186	150
Ceramic	63 × 47μF + 63 × 100μF	7917	1090	14	2121	6	212	150
Ceramic	72 × 47μF + 72 × 100μF	9024	1180	15	2418	6	242	150
Ceramic	82 × 47μF + 82 × 100μF	10254	1290	16	2748	7	275	150
Ceramic	93 × 47μF + 93 × 100μF	11607	1400	17	3110	7	311	150
Ceramic	105 × 47μF + 105 × 100μF	13083	1520	18	3506	7	351	150
Ceramic	120 × 47μF + 120 × 100μF	14928	1640	19	4000	8	400	150
Ceramic + Polymer	12 × 47μF + 2 × 1000μF	2672	1760	20	501	3	300	220
Ceramic + Polymer	12 × 47μF + 3 × 1000μF	3672	1890	21	688	3	413	220
Ceramic + Polymer	12 × 47μF + 4 × 1000μF	4672	2030	22	876	3	525	220
Ceramic + Polymer	12 × 47μF + 5 × 1000μF	5672	2150	23	1063	4	638	220
Ceramic + Polymer	12 × 47μF + 6 × 1000μF	6672	2320	24	1250	4	750	220
Ceramic + Polymer	12 × 47μF + 7 × 1000μF	7672	2460	25	1438	4	860	220
Ceramic + Polymer	12 × 47μF + 8 × 1000μF	8672	2640	26	1625	5	975	220
Ceramic + Polymer	12 × 47μF + 9 × 1000μF	9672	2840	27	1813	5	1088	220
Ceramic + Polymer	12 × 47μF + 10 × 1000μF	10672	3010	28	2000	5	1200	220
Ceramic + Polymer	12 × 47μF + 11 × 1000μF	11672	3200	29	2187	5	1312	220
Ceramic + Polymer	12 × 47μF + 12 × 1000μF	12672	3400	30	2375	5	1425	220
Ceramic + Polymer	12 × 47μF + 13 × 1000μF	13672	3650	31	2562	6	1537	220
Ceramic + Polymer	12 × 47μF + 15 × 1000μF	15672	3880	32	2937	6	1762	220
Ceramic + Polymer	12 × 47μF + 17 × 1000μF	17672	4120	33	3312	6	1987	220
Ceramic + Polymer	12 × 47μF + 19 × 1000μF	19672	4420	34	3687	7	2212	220
Ceramic + Polymer	12 × 47μF + 21 × 1000μF	21672	4700	35	4061	7	2437	220
Ceramic + Polymer	12 × 47μF + 23 × 1000μF	23672	5050	36	4436	7	2662	220
Ceramic + Polymer	12 × 47μF + 25 × 1000μF	25672	5360	37	4811	8	2887	220
Ceramic + Polymer	12 × 47μF + 27 × 1000μF	27672	5760	38	5186	8	3112	220
Ceramic + Polymer	12 × 47μF + 30 × 1000μF	30672	6120	39	5748	8	3449	220

** Total output capacitance includes the capacitance inside the module is 4 × 47μF (3mΩ ESR).

Note: The capacitors used in the digital compensation Loop tables are 47μF/3 mΩ ESR ceramic, 100uF/3.2mΩ ceramic, 1000 μF/6mΩ ESR polymer capacitor and 820uF/19mΩ ESR Polymer capacitor.

170A TeraDLynx™: Non-Isolated DC-DC Power Modules

7Vdc –14Vdc input; 0.6Vdc to 1.5Vdc output; 170A Output Current

Table 2 (continued). RTUNE compensation table

Output Capacitance Type	Number of Output Capacitors**	Total Output Capacitance (µF)**	RTUNE resistor (Ω)	RTUNE Index	KD	KI	KP	AP
Ceramic + Electrolytic	12 x 47µF + 2 x 820µF	2312	6570	40	176	2	176	220
Ceramic + Electrolytic	12 x 47µF + 3 x 820µF	3312	7060	41	238	3	238	220
Ceramic + Electrolytic	12 x 47µF + 4 x 820µF	3952	7590	42	301	3	301	220
Ceramic + Electrolytic	12 x 47µF + 5 x 820µF	4772	8160	43	363	3	363	220
Ceramic + Electrolytic	12 x 47µF + 6 x 820µF	5592	8870	44	426	4	426	220
Ceramic + Electrolytic	12 x 47µF + 7 x 820µF	6412	9530	45	488	4	488	220
Ceramic + Electrolytic	12 x 47µF + 8 x 820µF	7312	10400	46	550	4	550	220
Ceramic + Electrolytic	12 x 47µF + 9 x 820µF	8052	11300	47	613	4	613	220
Ceramic + Electrolytic	12 x 47µF + 10 x 820µF	8872	12400	48	675	5	675	220
Ceramic + Electrolytic	12 x 47µF + 11 x 820µF	9692	13700	49	738	5	738	220
Ceramic + Electrolytic	12 x 47µF + 12 x 820µF	10512	15000	50	800	5	800	220
Ceramic + Electrolytic	12 x 47µF + 14 x 820µF	12152	16700	51	925	5	925	220
Ceramic + Electrolytic	12 x 47µF + 16 x 820µF	13792	18700	52	1050	6	1050	220
Ceramic + Electrolytic	12 x 47µF + 18 x 820µF	15432	21000	53	1174	6	1174	220
Ceramic + Electrolytic	12 x 47µF + 20 x 820µF	17072	24000	54	1299	6	1299	220
Ceramic + Electrolytic	12 x 47µF + 23 x 820µF	19532	28000	55	1486	7	1486	220
Ceramic + Electrolytic	12 x 47µF + 26 x 820µF	21992	33000	56	1674	7	1674	220
Ceramic + Electrolytic	12 x 47µF + 29 x 820µF	24452	40200	57	1861	8	1861	220
Ceramic + Electrolytic	12 x 47µF + 32 x 820µF	26912	50500	58	2048	8	2048	220
Ceramic + Electrolytic	12 x 47µF + 36 x 820µF	30192	68000	59	2298	8	2298	220

** Total output capacitance includes the capacitance inside the module is 4 x 47µF (3mΩ ESR).

Note: The capacitors used in the digital compensation Loop tables are 47µF/3 mΩ ESR ceramic, 100µF/3.2mΩ ceramic, 1000 µF/6mΩ ESR polymer capacitor and 820µF/19mΩ ESR Electrolytic capacitor.

Power Module Wizard

GE offers a free web based easy to use tool that helps users simulate the Tunable Loop performance of the TJT170. Go to <http://ge.transim.com/pmd/Home> and sign up for a free account and use the module selector tool. The tool also offers downloadable Simplis/Simatrix models that can be used to assess transient performance, module stability, etc.

Bin 'a' and Bin 'b' settings using the models available through Power Module Wizard

The TJT170 module has a built-in non-linear compensation adjustment to speed up its transient response to dynamic loading conditions. When the module senses a load transition in progress, it automatically adjusts the KD, KI, KP settings to higher values and then reverts to the values set before the transient conditions. The adjustment of the PID coefficients is as follows:

Steady State			Transient Condition		
Bin 'a' – User set values based on RTUNE or programmed			Bin 'b' – Controller adjusted values for duration of transient		
KD	KI	KP	KD	KI	KP
A	B	X	1.5 x A	2 x B	2 x C

For determining the voltage response to a current load transient, it is more accurate to use the Bin 'b' settings corresponding to the selected KD, KI, KP values. For Loop Stability Simulations, the selected PID values corresponding to Bin 'a' should be used.

170A TeraDlynx™: Non-Isolated DC-DC Power Modules

7Vdc –14Vdc input; 0.6Vdc to 1.5Vdc output; 170A Output Current

Digital Feature Descriptions

PMBus Interface Capability

The 170A TeraDlynx power modules have a PMBus interface that supports both communication and control. The PMBus Power Management Protocol Specification can be obtained from www.pmbus.org. The modules support a subset of version 1.1 of the specification (see Table 4 for a list of the specific commands supported). Most module parameters can be programmed using PMBus and stored as defaults for later use.

Communication over the module PMBus interface supports the Packet Error Checking (PEC) scheme. The PMBus master must generate the correct PEC byte for all transactions, and check the PEC byte returned by the module.

The module also supports the SMBALERT# response protocol whereby the module can alert the bus master if it wants to talk. For more information on the SMBus alert response protocol, see the System Management Bus (SMBus) specification.

The module has non-volatile memory that is used to store configuration settings. Not all settings programmed into the device are automatically saved into this non-volatile memory, only those specifically identified as capable of being stored can be saved (see Table 4 for which command parameters can be saved to non-volatile storage).

PMBus Data Format

For commands that set thresholds, voltages or report such quantities, the module supports the “Linear” data format among the three data formats supported by PMBus. The Linear Data Format is a two-byte value with an 11-bit, two’s complement mantissa and a 5-bit, two’s complement exponent. The format of the two data bytes is shown below:

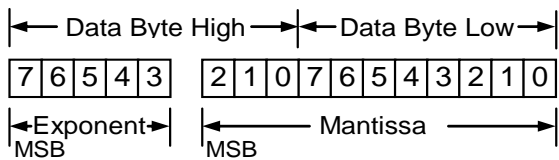

The value is of the number is then given by

$$\text{Value} = \text{Mantissa} \times 2^{\text{Exponent}}$$

PMBus Addressing

The power module is addressed through the PMBus using a device address. The module supports 128 possible addresses (0 to 127 in decimal) which can be set using resistors connected from the ADDR0 and ADDR1 pins to SIG_GND. Note that some of these addresses (0, 1, 2, 3, 4, 5, 6, 7, 8, 9, 10, 11, 12, 40, 44, 45, 55 in decimal) are reserved according to the SMBus specification and may not be useable. The address is set in the form of two octal (0 to 7) digits, with each pin setting one digit. The ADDR1 pin sets the high order digit and ADDR0 sets the low order digit. The resistor values suggested for each digit are shown in Table 3 (E96 series resistors are recommended). Note that if either address resistor value is outside the range specified in Table 4, the module will respond to address 127.

The user must know which I²C addresses are reserved in a system for special functions and set the address of the module to avoid interfering with other system operations. Both 100kHz and 400kHz bus speeds are supported by the module. Connection for the PMBus interface should follow the High Power DC specifications given in section 3.1.3 in the SMBus specification V2.0 for the 400kHz bus speed or the

Low Power DC specifications in section 3.1.2. The complete SMBus specification is available from the SMBus web site, smbus.org.

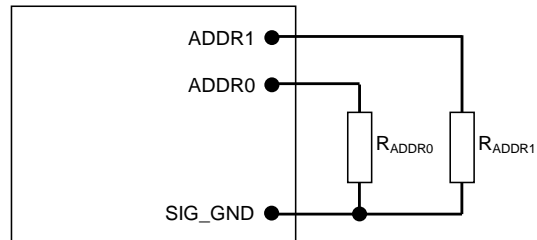

Figure 37. Circuit showing connection of resistors used to set the PMBus address of the module.

Table 3

PMBus Address Table											
ADDR0 Resistor Values	ADDR1 Resistor Values										
	4.99K	15.4k	27.4K	41.2K	54.9K	71.5K	90.9K	110K	137K	162K	191K
4.99K	1	13	25	37	49	61	73	85	97	109	121
15.4K	2	14	26	38	50	62	74	86	98	110	122
27.4K	3	15	27	39	51	63	75	87	99	111	123
41.2K	4	16	28	40	52	64	76	88	100	112	124
54.9K	5	17	29	41	53	65	77	89	101	113	125
71.5K	6	18	30	42	54	66	78	90	102	114	126
90.9K	7	19	31	43	55	67	79	91	103	115	127
110K	8	20	32	44	56	68	80	92	104	116	64
137K	9	21	33	45	57	69	81	93	105	117	64
162K	10	22	34	46	58	70	82	94	106	118	64
191K	11	23	35	47	59	71	83	95	107	119	64
232K	12	24	36	48	60	72	84	96	108	120	64

170A TeraDLynx™: Non-Isolated DC-DC Power Modules

7Vdc –14Vdc input; 0.6Vdc to 1.5Vdc output; 170A Output Current

Operation (01h)

This is a paged register. The OPERATION command can be used to turn the module on or off in conjunction with the ON/OFF pin input. It is also used to margin up or margin down the output voltage

PMBus Enabled On/Off

The module can also be turned on and off via the PMBus interface. The OPERATION command is used to actually turn the module on and off via the PMBus, while the ON_OFF_CONFIG command configures the combination of analog ON/OFF pin input and PMBus commands needed to turn the module on and off. Bit [7] in the OPERATION command data byte enables the module, with the following functions:

- 0 : Output is disabled
- 1 : Output is enabled

This module uses the lower five bits of the ON_OFF_CONFIG data byte to set various ON/OFF options as follows:

Bit Position	4	3	2	1	0
Access	r/w	r/w	r/w	r	r
Function	PU	CMD	CPR	X	CPA
Default Value	1	0	1	x	1

PU: Sets the default to either operate any time input power is present or for the ON/OFF to be controlled by the analog ON/OFF input and the PMBus OPERATION command. This bit is used together with the CP, CMD and ON bits to determine startup.

Bit Value	Action
0	Module powers up any time power is present regardless of state of the analog ON/OFF pin
1	Module does not power up until commanded by the analog ON/OFF pin and the OPERATION command as programmed in bits [2:0] of the ON_OFF_CONFIG register.

CMD: The CMD bit controls how the device responds to the OPERATION command.

Bit Value	Action
0	Module ignores the ON bit in the OPERATION command
1	Module responds to the ON bit in the OPERATION command

CPR: Sets the response of the analog ON/OFF pin. This bit is used together with the CMD, PU and ON bits to determine startup.

Bit Value	Action
0	Module ignores the analog ON/OFF pin, i.e. ON/OFF is only controlled through the PMBUS via the OPERATION command
1	Module requires the analog ON/OFF pin to be asserted to start the unit

CPA: Sets the action of the analog ON/OFF pin when turning the controller OFF. This bit is internally read and cannot be modified by the user

PMBus Adjustable Soft Start Rise Time

The soft start rise time of module output is adjustable in the module via PMBus. The TON_RISE command can set the rise time in ms, and allows choosing soft start times between 1 and 1000ms. Rise time below 10msec may cause the module to overshoot its voltage setpoint during startup

Output Voltage Adjustment Using the PMBus

Two PMBus commands are available to change the output voltage setting. The first, VOUT_COMMAND can set the output voltage directly. The second, VOUT_TRIM is used to apply an offset to the commanded output voltage.

Since the output voltage can be set using an external RTrim resistor as well, an additional PMBus command MFR_VOUT_SET_MODE is used to tell the module whether the VOUT_COMMAND is used to directly set output voltage or whether RTrim is to be used. If MFR_VOUT_SET_MODE is set to where bit position 7 is set at 1, then VOUT_COMMAND is ignored and output voltage is set solely by RTrim. If bit 7 of MFR_VOUT_SET_MODE is set to 0, then output voltage is set using VOUT_COMMAND, and the value of RTrim is only used at startup to set the output voltage.

The second output voltage adjustment command VOUT_TRIM works in either case to provide a fixed offset to the output voltage. This allows PMBus adjustment of the output voltage irrespective of how MFR_VOUT_SET_MODE is set and allows digital adjustment of the output voltage setting even when RTrim is used.

For all digital commands used to set or adjust the output voltage via PMBus, the resolution is 98µV.

Output Voltage Margining Using the PMBus

The output voltage of the module can be margined via PMBus between 0.6 and 1.5V. The margining voltage can be adjusted in 98µV steps.

PMBus Adjustable Overcurrent Warning

The module can provide an overcurrent warning via the PMBus. The threshold for the overcurrent warning can be set using the parameter IOUT_OC_WARN_LIMIT. This command uses the “Linear” data format with a two byte data word where the upper five bits [7:3] of the high byte represent the exponent and the remaining three bits of the high byte [2:0] and the eight bits in the low byte represent the mantissa. The value of the IOUT_OC_WARN_LIMIT can be stored to non-volatile memory using the STORE_DEFAULT_ALL command.

Temperature Status via PMBus

The module provides information related to temperature of the module through standardized PMBus commands. Commands READ_TEMPERATURE1, READ_TEMPERATURE_2 are mapped to module temperature and internal temperature of the PWM controller, respectively. The temperature readings are returned in °C and in two bytes.

170A TeraDLynx™: Non-Isolated DC-DC Power Modules

7Vdc –14Vdc input; 0.6Vdc to 1.5Vdc output; 170A Output Current

PMBus Adjustable Output Over, Under Voltage Protection

The module has output over and under voltage protection capability. The PMBus command VOUT_OV_FAULT_LIMIT is used to set the output over voltage threshold. The default value is configured to be 112.5% of the commanded output. The command VOUT_UV_FAULT_LIMIT sets the threshold that detects an output under voltage fault. The default values are 87.5% of the commanded output voltage. Both commands use two data bytes formatted in the Linear format.

PMBus Adjustable Input Undervoltage Lockout

The module allows adjustment of the input under voltage lockout and hysteresis. The command VIN_ON allows setting the input voltage turn on threshold, while the VIN_OFF command sets the input voltage turn off threshold. For the VIN_ON command possible values are 7 to 14V and for the VIN_OFF command, possible values are 6.75V to 14V. Both VIN_ON and VIN_OFF commands use the “Linear” format with two data bytes.

Measurement of Output Current, Output Voltage and Input Voltage

The module can measure key module parameters such as output current, output voltage and input voltage and provide this information through the PMBus interface.

Measuring Output Current Using the PMBus

The module measures output current by using a signal derived from the switching FET currents. The current gain factor is accessed using the IOUT_CAL_GAIN command, and consists of two bytes in the Linear data format. During manufacture, each module is calibrated by measuring and storing the current gain factor into non-volatile storage.

The current measurement accuracy is also improved by each module being calibrated during manufacture with the offset in the current reading. The IOUT_CAL_OFFSET command is used to store and read the current offset. The READ_IOUT command provides module average output current information. This command only supports positive output current, i.e. current sourced from the module. If the converter is sinking current a reading of 0 is provided. The READ_IOUT command returns two bytes of data in the Linear data format.

Measuring Output Voltage Using the PMBus

The module provides output voltage information using the READ_VOUT command. The command returns two bytes of data in Linear format.

Measuring Input Voltage Using the PMBus

The module provides input voltage information using the READ_VIN command. The command returns two bytes of data in the Linear format.

Reading the Status of the Module using the PMBus

The module supports a number of status information commands implemented in PMBus. A 1 in the bit position indicates the fault that is flagged.

STATUS_BYTE: Returns one byte of information with a summary of the most critical device faults.

Bit Position	Flag	Default Value
7	X	0
6	OFF	0
5	VOUT Overvoltage	0
4	IOUT Overcurrent	0
3	VIN Undervoltage	0
2	Temperature	0
1	CML (Comm. Memory Fault)	0
0	None of the above	0

STATUS_WORD: Returns two bytes of information with a summary of the module’s fault/warning conditions.

Low Byte

Bit Position	Flag	Default Value
7	X	0
6	OFF	0
5	VOUT Overvoltage	0
4	IOUT Overcurrent	0
3	VIN Undervoltage	0
2	Temperature	0
1	CML (Comm. Memory Fault)	0
0	None of the above	0

High Byte

Bit Position	Flag	Default Value
7	VOUT fault or warning	0
6	IOUT fault or warning	0
5	X	0
4	X	0
3	POWER_GOOD# (is negated)	0
2	X	0
1	X	0
0	X	0

STATUS_VOUT: Returns one byte of information relating to the status of the module’s output voltage related faults.

Bit Position	Flag	Default Value
7	VOUT OV Fault	0
6	VOUT_OV_WARNING	0
5	VOUT_UV_WARNING	0
4	VOUT UV Fault	0
3	X	0
2	X	0
1	X	0
0	X	0

STATUS_IOUT: Returns one byte of information relating to the status of the module’s output voltage related faults.

170A TeraDlynx™: Non-Isolated DC-DC Power Modules

7Vdc –14Vdc input; 0.6Vdc to 1.5Vdc output; 170A Output Current

Bit Position	Flag	Default Value
7	IOUT OC Fault	0
6	X	0
5	IOUT OC Warning	0
4	X	0
3	X	0
2	X	0
1	X	0
0	X	0

STATUS_TEMPERATURE: Returns one byte of information relating to the status of the module’s temperature related faults.

Bit Position	Flag	Default Value
7	OT Fault	0
6	OT Warning	0
5	X	0
4	X	0
3	X	0
2	X	0
1	X	0
0	X	0

STATUS_CML: Returns one byte of information relating to the status of the module’s communication related faults.

Bit Position	Flag	Default Value
7	Invalid/Unsupported Command	0
6	Invalid/Unsupported Data	0
5	Packet Error Check Failed	0
4	Memory Fault Detected	0
3	X	0
2	X	0
1	Other Communication Fault	0
0	X	0

MFR_SPECIFIC_00: Returns information related to the type of module and revision number. Bits [7:2] in the Low Byte indicate the module type (001110 corresponds to the TJT170 series of module), while bits [7:3] in the high byte indicate the revision number of the module.

Low Byte

Bit Position	Flag	Default Value
7:2	Module Name	001110
1:0	Reserved	10

High Byte

Bit Position	Flag	Default Value
7:3	Module Revision Number	None
2:0	Reserved	000

User-Programmable Compensation Coefficients

The output voltage control compensation coefficients can be changed by the user via PMBus commands. On startup, the module uses stored values of the four compensation parameters KD, KI, KP and ALPHA. If the module detects a valid value of RTUNE connected to the module, the values of KD, KI, KP and ALPHA are then changed to the appropriate values. Beyond this, the user can use the PMBus commands listed below to overwrite the values of KD, KP, KI and ALPHA.

MFR_SPECIFIC_KP: Allows the user to program the value of the KP compensation coefficient. The allowed range is - 32768 to 32767. The entire 16 bits are used to enter this range of integer values in two’s complement binary format. For stable operation, the maximum allowed value is 10922

MFR_SPECIFIC_KI: Allows the user to program the value of the KI compensation coefficient. The allowed range is - 32768 to 32767. The entire 16 bits are used to enter this range of integer values in two’s complement binary format. For stable operation, the maximum allowed value is 10922

MFR_SPECIFIC_KD: Allows the user to program the value of the KD compensation coefficient. The allowed range is - 32768 to 32767. The entire 16 bits are used to enter this range of integer values in two’s complement binary format. For stable operation, the maximum allowed value is 10922

MFR_SPECIFIC_ALPHA: Allows the user to program the value of the ALPHA compensation coefficient. The allowed range is -256 to 256. The entire 16 bits are used to enter this range of integer values in two’s complement binary format.

170A TeraDlynx™: Non-Isolated DC-DC Power Modules

7Vdc –14Vdc input; 0.6Vdc to 1.5Vdc output; 170A Output Current

Summary of Supported PMBus Commands

Please refer to the PMBus 1.1 specification for more details of these commands. For the registers where a range is specified, any value outside the range is ignored and the module continues to use the previous value.

Table 4

Hex Code	Command	Brief Description	Non-Volatile Memory Storage																																																																																	
01	OPERATION	Turn Module on or off. Also used to margin the output voltage <table border="1"> <tr> <th>Format</th> <td colspan="8">Unsigned Binary</td> </tr> <tr> <th>Bit Position</th> <td>7</td><td>6</td><td>5</td><td>4</td><td>3</td><td>2</td><td>1</td><td>0</td> </tr> <tr> <th>Access</th> <td>r/w</td><td>r</td><td>r/w</td><td>r/w</td><td>r/w</td><td>r/w</td><td>r</td><td>r</td> </tr> <tr> <th>Function</th> <td>On</td><td>X</td><td colspan="4">Margin</td><td>X</td><td>X</td> </tr> <tr> <th>Default Value</th> <td>1</td><td>0</td><td>0</td><td>0</td><td>0</td><td>0</td><td>X</td><td>X</td> </tr> </table>	Format	Unsigned Binary								Bit Position	7	6	5	4	3	2	1	0	Access	r/w	r	r/w	r/w	r/w	r/w	r	r	Function	On	X	Margin				X	X	Default Value	1	0	0	0	0	0	X	X	YES																																				
Format	Unsigned Binary																																																																																			
Bit Position	7	6	5	4	3	2	1	0																																																																												
Access	r/w	r	r/w	r/w	r/w	r/w	r	r																																																																												
Function	On	X	Margin				X	X																																																																												
Default Value	1	0	0	0	0	0	X	X																																																																												
02	ON_OFF_CONFIG	Configures the ON/OFF functionality as a combination of analog ON/OFF pin and PMBus commands <table border="1"> <tr> <th>Format</th> <td colspan="8">Unsigned Binary</td> </tr> <tr> <th>Bit Position</th> <td>7</td><td>6</td><td>5</td><td>4</td><td>3</td><td>2</td><td>1</td><td>0</td> </tr> <tr> <th>Access</th> <td>r</td><td>r</td><td>r</td><td>r/w</td><td>r/w</td><td>r/w</td><td>r</td><td>r</td> </tr> <tr> <th>Function</th> <td>X</td><td>X</td><td>X</td><td>pu</td><td>cmd</td><td>cpr</td><td>X</td><td>cpa</td> </tr> <tr> <th>Default Value</th> <td>0</td><td>0</td><td>0</td><td>1</td><td>0</td><td>1</td><td>x</td><td>1</td> </tr> </table>	Format	Unsigned Binary								Bit Position	7	6	5	4	3	2	1	0	Access	r	r	r	r/w	r/w	r/w	r	r	Function	X	X	X	pu	cmd	cpr	X	cpa	Default Value	0	0	0	1	0	1	x	1	YES																																				
Format	Unsigned Binary																																																																																			
Bit Position	7	6	5	4	3	2	1	0																																																																												
Access	r	r	r	r/w	r/w	r/w	r	r																																																																												
Function	X	X	X	pu	cmd	cpr	X	cpa																																																																												
Default Value	0	0	0	1	0	1	x	1																																																																												
03	CLEAR_FAULTS	Clear any fault bits that may have been set, also releases the SMBALERT# signal if the device has been asserting it.																																																																																		
10	WRITE_PROTECT	Used to control writing to the module via PMBus. Copies the current register setting in the module whose command code matches the value in the data byte into non-volatile memory (EEPROM) on the module <table border="1"> <tr> <th>Format</th> <td colspan="8">Unsigned Binary</td> </tr> <tr> <th>Bit Position</th> <td>7</td><td>6</td><td>5</td><td>4</td><td>3</td><td>2</td><td>1</td><td>0</td> </tr> <tr> <th>Access</th> <td>r/w</td><td>r/w</td><td>r/w</td><td>x</td><td>x</td><td>x</td><td>x</td><td>x</td> </tr> <tr> <th>Function</th> <td>bit7</td><td>bit6</td><td>bit5</td><td>X</td><td>X</td><td>X</td><td>X</td><td>X</td> </tr> <tr> <th>Default Value</th> <td>0</td><td>0</td><td>0</td><td>X</td><td>X</td><td>X</td><td>X</td><td>X</td> </tr> </table> <p>Bit5: 0 – Enables all writes as permitted in bit6 or bit7 1 – Disables all writes except the WRITE_PROTECT, OPERATION and ON_OFF_CONFIG (bit 6 and bit7 must be 0) Bit 6: 0 – Enables all writes as permitted in bit5 or bit7 1 – Disables all writes except for the WRITE_PROTECT and OPERATION commands (bit5 and bit7 must be 0) Bit7: 0 – Enables all writes as permitted in bit5 or bit6 1 – Disables all writes except for the WRITE_PROTECT command (bit5 and bit6 must be 0)</p>	Format	Unsigned Binary								Bit Position	7	6	5	4	3	2	1	0	Access	r/w	r/w	r/w	x	x	x	x	x	Function	bit7	bit6	bit5	X	X	X	X	X	Default Value	0	0	0	X	X	X	X	X	YES																																				
Format	Unsigned Binary																																																																																			
Bit Position	7	6	5	4	3	2	1	0																																																																												
Access	r/w	r/w	r/w	x	x	x	x	x																																																																												
Function	bit7	bit6	bit5	X	X	X	X	X																																																																												
Default Value	0	0	0	X	X	X	X	X																																																																												
11	STORE_DEFAULT_ALL	Copies all current register settings in the module into non-volatile memory (EEPROM) on the module. Takes about 50ms for the command to execute.																																																																																		
12	RESTORE_DEFAULT_ALL	Restores all current register settings in the module from values in the module non-volatile memory (EEPROM)																																																																																		
20	VOUT_MODE	The module has MODE set to Linear and Exponent set to -14. These values cannot be changed <table border="1"> <tr> <th>Bit Position</th> <td>7</td><td>6</td><td>5</td><td>4</td><td>3</td><td>2</td><td>1</td><td>0</td> </tr> <tr> <th>Access</th> <td>r</td><td>r</td><td>r</td><td>r</td><td>r</td><td>r</td><td>r</td><td>r</td> </tr> <tr> <th>Function</th> <td colspan="4">Mode</td> <td colspan="4">2's complement Exponent</td> </tr> <tr> <th>Default Value</th> <td>0</td><td>0</td><td>0</td><td>1</td><td>0</td><td>0</td><td>1</td><td>0</td> </tr> </table>	Bit Position	7	6	5	4	3	2	1	0	Access	r	r	r	r	r	r	r	r	Function	Mode				2's complement Exponent				Default Value	0	0	0	1	0	0	1	0																																														
Bit Position	7	6	5	4	3	2	1	0																																																																												
Access	r	r	r	r	r	r	r	r																																																																												
Function	Mode				2's complement Exponent																																																																															
Default Value	0	0	0	1	0	0	1	0																																																																												
21	VOUT_COMMAND	Set desired output voltage. Only 16-bit unsigned mantissa – implied exponent of -14 per VOOUT_MODE command. Valid range is 0.6 to 1.5V. <table border="1"> <tr> <th>Format</th> <td colspan="8">Unsigned Mantissa</td> </tr> <tr> <th>Bit Position</th> <td>15</td><td>14</td><td>13</td><td>12</td><td>11</td><td>10</td><td>9</td><td>8</td> </tr> <tr> <th>Access</th> <td>r/w</td><td>r/w</td><td>r/w</td><td>r/w</td><td>r/w</td><td>r/w</td><td>r/w</td><td>r/w</td> </tr> <tr> <th>Function</th> <td colspan="8">Mantissa</td> </tr> <tr> <th>Default Value</th> <td colspan="8">Variable</td> </tr> <tr> <th>Bit Position</th> <td>7</td><td>6</td><td>5</td><td>4</td><td>3</td><td>2</td><td>1</td><td>0</td> </tr> <tr> <th>Access</th> <td>r/w</td><td>r/w</td><td>r/w</td><td>r/w</td><td>r/w</td><td>r/w</td><td>r/w</td><td>r/w</td> </tr> <tr> <th>Function</th> <td colspan="8">Mantissa</td> </tr> <tr> <th>Default Value</th> <td colspan="8">Variable</td> </tr> </table>	Format	Unsigned Mantissa								Bit Position	15	14	13	12	11	10	9	8	Access	r/w	r/w	r/w	r/w	r/w	r/w	r/w	r/w	Function	Mantissa								Default Value	Variable								Bit Position	7	6	5	4	3	2	1	0	Access	r/w	r/w	r/w	r/w	r/w	r/w	r/w	r/w	Function	Mantissa								Default Value	Variable								YES
Format	Unsigned Mantissa																																																																																			
Bit Position	15	14	13	12	11	10	9	8																																																																												
Access	r/w	r/w	r/w	r/w	r/w	r/w	r/w	r/w																																																																												
Function	Mantissa																																																																																			
Default Value	Variable																																																																																			
Bit Position	7	6	5	4	3	2	1	0																																																																												
Access	r/w	r/w	r/w	r/w	r/w	r/w	r/w	r/w																																																																												
Function	Mantissa																																																																																			
Default Value	Variable																																																																																			

170A TeraDlynx™: Non-Isolated DC-DC Power Modules
 7Vdc –14Vdc input; 0.6Vdc to 1.5Vdc output; 170A Output Current

Table 4 (continued)

Hex Code	Command	Brief Description	Non-Volatile Memory Storage																																																																																	
22	VOUT_TRIM	<p>Apply a fixed offset voltage to the set output voltage from either the RTrim resistor or the VOUT_COMMAND. Implied exponent of -14 per VOUT_MODE command. Allowed range is ±300mV.</p> <table border="1"> <tr> <td>Format</td> <td colspan="8">Linear, two's complement binary</td> </tr> <tr> <td>Bit Position</td> <td>15</td> <td>14</td> <td>13</td> <td>12</td> <td>11</td> <td>10</td> <td>9</td> <td>8</td> </tr> <tr> <td>Access</td> <td>r/w</td> <td>r/w</td> <td>r/w</td> <td>r/w</td> <td>r/w</td> <td>r/w</td> <td>r/w</td> <td>r/w</td> </tr> <tr> <td>Function</td> <td colspan="8">Mantissa</td> </tr> <tr> <td>Default Value</td> <td>0</td> <td>0</td> <td>0</td> <td>0</td> <td>0</td> <td>0</td> <td>0</td> <td>0</td> </tr> <tr> <td>Bit Position</td> <td>7</td> <td>6</td> <td>5</td> <td>4</td> <td>3</td> <td>2</td> <td>1</td> <td>0</td> </tr> <tr> <td>Access</td> <td>r/w</td> <td>r/w</td> <td>r/w</td> <td>r/w</td> <td>r/w</td> <td>r/w</td> <td>r/w</td> <td>r/w</td> </tr> <tr> <td>Function</td> <td colspan="8">Mantissa</td> </tr> <tr> <td>Default Value</td> <td>0</td> <td>0</td> <td>0</td> <td>0</td> <td>0</td> <td>0</td> <td>0</td> <td>0</td> </tr> </table>	Format	Linear, two's complement binary								Bit Position	15	14	13	12	11	10	9	8	Access	r/w	r/w	r/w	r/w	r/w	r/w	r/w	r/w	Function	Mantissa								Default Value	0	0	0	0	0	0	0	0	Bit Position	7	6	5	4	3	2	1	0	Access	r/w	r/w	r/w	r/w	r/w	r/w	r/w	r/w	Function	Mantissa								Default Value	0	0	0	0	0	0	0	0	YES
Format	Linear, two's complement binary																																																																																			
Bit Position	15	14	13	12	11	10	9	8																																																																												
Access	r/w	r/w	r/w	r/w	r/w	r/w	r/w	r/w																																																																												
Function	Mantissa																																																																																			
Default Value	0	0	0	0	0	0	0	0																																																																												
Bit Position	7	6	5	4	3	2	1	0																																																																												
Access	r/w	r/w	r/w	r/w	r/w	r/w	r/w	r/w																																																																												
Function	Mantissa																																																																																			
Default Value	0	0	0	0	0	0	0	0																																																																												
23	VOUT_CAL_OFFSET	<p>Applies an offset to the commanded output voltage to calibrate out errors in setting module output voltage (between -100mV and +100mV) and when output voltage is set via the PMBus command VOUT_COMMAND (21). Implied exponent of -14 per VOUT_MODE command.</p> <table border="1"> <tr> <td>Format</td> <td colspan="8">Linear, two's complement binary</td> </tr> <tr> <td>Bit Position</td> <td>15</td> <td>14</td> <td>13</td> <td>12</td> <td>11</td> <td>10</td> <td>9</td> <td>8</td> </tr> <tr> <td>Access</td> <td>r/w</td> <td>r</td> <td>r</td> <td>r</td> <td>r</td> <td>r</td> <td>r</td> <td>r</td> </tr> <tr> <td>Function</td> <td colspan="8">Mantissa</td> </tr> <tr> <td>Default Value</td> <td colspan="8">Variable based on factory calibration</td> </tr> <tr> <td>Bit Position</td> <td>7</td> <td>6</td> <td>5</td> <td>4</td> <td>3</td> <td>2</td> <td>1</td> <td>0</td> </tr> <tr> <td>Access</td> <td>r</td> <td>r/w</td> <td>r/w</td> <td>r/w</td> <td>r/w</td> <td>r/w</td> <td>r/w</td> <td>r/w</td> </tr> <tr> <td>Function</td> <td colspan="8">Mantissa</td> </tr> <tr> <td>Default Value</td> <td colspan="8">Variable based on factory calibration</td> </tr> </table>	Format	Linear, two's complement binary								Bit Position	15	14	13	12	11	10	9	8	Access	r/w	r	r	r	r	r	r	r	Function	Mantissa								Default Value	Variable based on factory calibration								Bit Position	7	6	5	4	3	2	1	0	Access	r	r/w	r/w	r/w	r/w	r/w	r/w	r/w	Function	Mantissa								Default Value	Variable based on factory calibration								YES
Format	Linear, two's complement binary																																																																																			
Bit Position	15	14	13	12	11	10	9	8																																																																												
Access	r/w	r	r	r	r	r	r	r																																																																												
Function	Mantissa																																																																																			
Default Value	Variable based on factory calibration																																																																																			
Bit Position	7	6	5	4	3	2	1	0																																																																												
Access	r	r/w	r/w	r/w	r/w	r/w	r/w	r/w																																																																												
Function	Mantissa																																																																																			
Default Value	Variable based on factory calibration																																																																																			
25	VOUT_MARGIN_HIGH	<p>Sets the target voltage for margining the output high. Implied exponent of -14 per VOUT_MODE command. Allowed range is 0.6 to 1.5V.</p> <table border="1"> <tr> <td>Format</td> <td colspan="8">Linear, two's complement binary</td> </tr> <tr> <td>Bit Position</td> <td>15</td> <td>14</td> <td>13</td> <td>12</td> <td>11</td> <td>10</td> <td>9</td> <td>8</td> </tr> <tr> <td>Access</td> <td>r/w</td> <td>r/w</td> <td>r/w</td> <td>r/w</td> <td>r/w</td> <td>r/w</td> <td>r/w</td> <td>r/w</td> </tr> <tr> <td>Function</td> <td colspan="8">Mantissa</td> </tr> <tr> <td>Default Value</td> <td colspan="8">Variable</td> </tr> <tr> <td>Bit Position</td> <td>7</td> <td>6</td> <td>5</td> <td>4</td> <td>3</td> <td>2</td> <td>1</td> <td>0</td> </tr> <tr> <td>Access</td> <td>r/w</td> <td>r/w</td> <td>r/w</td> <td>r/w</td> <td>r/w</td> <td>r/w</td> <td>r/w</td> <td>r/w</td> </tr> <tr> <td>Function</td> <td colspan="8">Mantissa</td> </tr> <tr> <td>Default Value</td> <td colspan="8">Variable</td> </tr> </table>	Format	Linear, two's complement binary								Bit Position	15	14	13	12	11	10	9	8	Access	r/w	r/w	r/w	r/w	r/w	r/w	r/w	r/w	Function	Mantissa								Default Value	Variable								Bit Position	7	6	5	4	3	2	1	0	Access	r/w	r/w	r/w	r/w	r/w	r/w	r/w	r/w	Function	Mantissa								Default Value	Variable								YES
Format	Linear, two's complement binary																																																																																			
Bit Position	15	14	13	12	11	10	9	8																																																																												
Access	r/w	r/w	r/w	r/w	r/w	r/w	r/w	r/w																																																																												
Function	Mantissa																																																																																			
Default Value	Variable																																																																																			
Bit Position	7	6	5	4	3	2	1	0																																																																												
Access	r/w	r/w	r/w	r/w	r/w	r/w	r/w	r/w																																																																												
Function	Mantissa																																																																																			
Default Value	Variable																																																																																			
26	VOUT_MARGIN_LOW	<p>Sets the target voltage for margining the output low. Implied exponent of -14 per VOUT_MODE command. Allowed range is 0.6 to 1.5V.</p> <table border="1"> <tr> <td>Format</td> <td colspan="8">Linear, two's complement binary</td> </tr> <tr> <td>Bit Position</td> <td>15</td> <td>14</td> <td>13</td> <td>12</td> <td>11</td> <td>10</td> <td>9</td> <td>8</td> </tr> <tr> <td>Access</td> <td>r/w</td> <td>r/w</td> <td>r/w</td> <td>r/w</td> <td>r/w</td> <td>r/w</td> <td>r/w</td> <td>r/w</td> </tr> <tr> <td>Function</td> <td colspan="8">Mantissa</td> </tr> <tr> <td>Default Value</td> <td colspan="8">Variable</td> </tr> <tr> <td>Bit Position</td> <td>7</td> <td>6</td> <td>5</td> <td>4</td> <td>3</td> <td>2</td> <td>1</td> <td>0</td> </tr> <tr> <td>Access</td> <td>r/w</td> <td>r/w</td> <td>r/w</td> <td>r/w</td> <td>r/w</td> <td>r/w</td> <td>r/w</td> <td>r/w</td> </tr> <tr> <td>Function</td> <td colspan="8">Mantissa</td> </tr> <tr> <td>Default Value</td> <td colspan="8">Variable</td> </tr> </table>	Format	Linear, two's complement binary								Bit Position	15	14	13	12	11	10	9	8	Access	r/w	r/w	r/w	r/w	r/w	r/w	r/w	r/w	Function	Mantissa								Default Value	Variable								Bit Position	7	6	5	4	3	2	1	0	Access	r/w	r/w	r/w	r/w	r/w	r/w	r/w	r/w	Function	Mantissa								Default Value	Variable								YES
Format	Linear, two's complement binary																																																																																			
Bit Position	15	14	13	12	11	10	9	8																																																																												
Access	r/w	r/w	r/w	r/w	r/w	r/w	r/w	r/w																																																																												
Function	Mantissa																																																																																			
Default Value	Variable																																																																																			
Bit Position	7	6	5	4	3	2	1	0																																																																												
Access	r/w	r/w	r/w	r/w	r/w	r/w	r/w	r/w																																																																												
Function	Mantissa																																																																																			
Default Value	Variable																																																																																			
35	VIN_ON	<p>Sets the value of input voltage at which the module turns on. Exponent is fixed at -6. Allowed range is 7 to 14V.</p> <table border="1"> <tr> <td>Format</td> <td colspan="8">Linear, two's complement binary</td> </tr> <tr> <td>Bit Position</td> <td>15</td> <td>14</td> <td>13</td> <td>12</td> <td>11</td> <td>10</td> <td>9</td> <td>8</td> </tr> <tr> <td>Access</td> <td>r</td> <td>r</td> <td>r</td> <td>r</td> <td>r</td> <td>r</td> <td>r/w</td> <td>r/w</td> </tr> <tr> <td>Function</td> <td colspan="4">Exponent</td> <td colspan="4">Mantissa</td> </tr> <tr> <td>Default Value</td> <td>1</td> <td>1</td> <td>0</td> <td>1</td> <td>0</td> <td>0</td> <td>0</td> <td>1</td> </tr> <tr> <td>Bit Position</td> <td>7</td> <td>6</td> <td>5</td> <td>4</td> <td>3</td> <td>2</td> <td>1</td> <td>0</td> </tr> <tr> <td>Access</td> <td>r/w</td> <td>r/w</td> <td>r/w</td> <td>r/w</td> <td>r/w</td> <td>r/w</td> <td>r/w</td> <td>r/w</td> </tr> <tr> <td>Function</td> <td colspan="8">Mantissa</td> </tr> <tr> <td>Default Value</td> <td>1</td> <td>1</td> <td>0</td> <td>0</td> <td>0</td> <td>0</td> <td>0</td> <td>0</td> </tr> </table>	Format	Linear, two's complement binary								Bit Position	15	14	13	12	11	10	9	8	Access	r	r	r	r	r	r	r/w	r/w	Function	Exponent				Mantissa				Default Value	1	1	0	1	0	0	0	1	Bit Position	7	6	5	4	3	2	1	0	Access	r/w	r/w	r/w	r/w	r/w	r/w	r/w	r/w	Function	Mantissa								Default Value	1	1	0	0	0	0	0	0	YES
Format	Linear, two's complement binary																																																																																			
Bit Position	15	14	13	12	11	10	9	8																																																																												
Access	r	r	r	r	r	r	r/w	r/w																																																																												
Function	Exponent				Mantissa																																																																															
Default Value	1	1	0	1	0	0	0	1																																																																												
Bit Position	7	6	5	4	3	2	1	0																																																																												
Access	r/w	r/w	r/w	r/w	r/w	r/w	r/w	r/w																																																																												
Function	Mantissa																																																																																			
Default Value	1	1	0	0	0	0	0	0																																																																												

170A TeraDlynx™: Non-Isolated DC-DC Power Modules

7Vdc -14Vdc input; 0.6Vdc to 1.5Vdc output; 170A Output Current

Table 4 (continued)

Hex Code	Command	Brief Description	Non-Volatile Memory Storage																																																																																	
36	VIN_OFF	<p>Sets the value of input voltage at which the module turns off. Exponent is fixed at -6. Allowed range is 6.75 to 14V.</p> <table border="1"> <tr> <td>Format</td> <td colspan="8">Linear, two's complement binary</td> </tr> <tr> <td>Bit Position</td> <td>15</td><td>14</td><td>13</td><td>12</td><td>11</td><td>10</td><td>9</td><td>8</td> </tr> <tr> <td>Access</td> <td>r</td><td>r</td><td>r</td><td>r</td><td>r</td><td>r</td><td>r/w</td><td>r/w</td> </tr> <tr> <td>Function</td> <td colspan="4">Exponent</td> <td colspan="4">Mantissa</td> </tr> <tr> <td>Default Value</td> <td>1</td><td>1</td><td>0</td><td>1</td><td>0</td><td>0</td><td>0</td><td>1</td> </tr> <tr> <td>Bit Position</td> <td>7</td><td>6</td><td>5</td><td>4</td><td>3</td><td>2</td><td>1</td><td>0</td> </tr> <tr> <td>Access</td> <td>r/w</td><td>r/w</td><td>r/w</td><td>r/w</td><td>r/w</td><td>r/w</td><td>r/w</td><td>r/w</td> </tr> <tr> <td>Function</td> <td colspan="8">Mantissa</td> </tr> <tr> <td>Default Value</td> <td>1</td><td>0</td><td>1</td><td>1</td><td>0</td><td>0</td><td>0</td><td>0</td> </tr> </table>	Format	Linear, two's complement binary								Bit Position	15	14	13	12	11	10	9	8	Access	r	r	r	r	r	r	r/w	r/w	Function	Exponent				Mantissa				Default Value	1	1	0	1	0	0	0	1	Bit Position	7	6	5	4	3	2	1	0	Access	r/w	r/w	r/w	r/w	r/w	r/w	r/w	r/w	Function	Mantissa								Default Value	1	0	1	1	0	0	0	0	YES
Format	Linear, two's complement binary																																																																																			
Bit Position	15	14	13	12	11	10	9	8																																																																												
Access	r	r	r	r	r	r	r/w	r/w																																																																												
Function	Exponent				Mantissa																																																																															
Default Value	1	1	0	1	0	0	0	1																																																																												
Bit Position	7	6	5	4	3	2	1	0																																																																												
Access	r/w	r/w	r/w	r/w	r/w	r/w	r/w	r/w																																																																												
Function	Mantissa																																																																																			
Default Value	1	0	1	1	0	0	0	0																																																																												
38	IOUT_CAL_GAIN	<p>Applies a gain correction to the READ_IOUT command results to calibrate out gain errors in module measurements of the output current. The number in this register is divided by 8192 to generate the correction factor. Allowed range is 6553 to 9830.</p> <table border="1"> <tr> <td>Format</td> <td colspan="8">Linear, two's complement binary</td> </tr> <tr> <td>Bit Position</td> <td>15</td><td>14</td><td>13</td><td>12</td><td>11</td><td>10</td><td>9</td><td>8</td> </tr> <tr> <td>Access</td> <td>r</td><td>r</td><td>r</td><td>r</td><td>r</td><td>r</td><td>r</td><td>r/w</td> </tr> <tr> <td>Function</td> <td colspan="8">Integer</td> </tr> <tr> <td>Default Value</td> <td colspan="8">Variable based on factory calibration</td> </tr> <tr> <td>Bit Position</td> <td>7</td><td>6</td><td>5</td><td>4</td><td>3</td><td>2</td><td>1</td><td>0</td> </tr> <tr> <td>Access</td> <td>r/w</td><td>r/w</td><td>r/w</td><td>r/w</td><td>r/w</td><td>r/w</td><td>r/w</td><td>r/w</td> </tr> <tr> <td>Function</td> <td colspan="8">Integer</td> </tr> <tr> <td>Default Value</td> <td colspan="8">Variable based on factory calibration</td> </tr> </table>	Format	Linear, two's complement binary								Bit Position	15	14	13	12	11	10	9	8	Access	r	r	r	r	r	r	r	r/w	Function	Integer								Default Value	Variable based on factory calibration								Bit Position	7	6	5	4	3	2	1	0	Access	r/w	r/w	r/w	r/w	r/w	r/w	r/w	r/w	Function	Integer								Default Value	Variable based on factory calibration								YES
Format	Linear, two's complement binary																																																																																			
Bit Position	15	14	13	12	11	10	9	8																																																																												
Access	r	r	r	r	r	r	r	r/w																																																																												
Function	Integer																																																																																			
Default Value	Variable based on factory calibration																																																																																			
Bit Position	7	6	5	4	3	2	1	0																																																																												
Access	r/w	r/w	r/w	r/w	r/w	r/w	r/w	r/w																																																																												
Function	Integer																																																																																			
Default Value	Variable based on factory calibration																																																																																			
39	IOUT_CAL_OFFSET	<p>Returns the value of the offset correction term used to correct the measured output current. The exponent is fixed at -2. The allowed range is -50 to +50A.</p> <table border="1"> <tr> <td>Format</td> <td colspan="8">Linear, two's complement binary</td> </tr> <tr> <td>Bit Position</td> <td>15</td><td>14</td><td>13</td><td>12</td><td>11</td><td>10</td><td>9</td><td>8</td> </tr> <tr> <td>Access</td> <td>r</td><td>r</td><td>r</td><td>r</td><td>r</td><td>r</td><td>r/w</td><td>r</td> </tr> <tr> <td>Function</td> <td colspan="4">Exponent</td> <td colspan="4">Mantissa</td> </tr> <tr> <td>Default Value</td> <td>1</td><td>1</td><td>1</td><td>1</td><td>0</td><td colspan="3">Variable</td> </tr> <tr> <td>Bit Position</td> <td>7</td><td>6</td><td>5</td><td>4</td><td>3</td><td>2</td><td>1</td><td>0</td> </tr> <tr> <td>Access</td> <td>r</td><td>r</td><td>r/w</td><td>r/w</td><td>r/w</td><td>r/w</td><td>r/w</td><td>r/w</td> </tr> <tr> <td>Function</td> <td colspan="8">Mantissa</td> </tr> <tr> <td>Default Value</td> <td colspan="8">Variable based on factory calibration</td> </tr> </table>	Format	Linear, two's complement binary								Bit Position	15	14	13	12	11	10	9	8	Access	r	r	r	r	r	r	r/w	r	Function	Exponent				Mantissa				Default Value	1	1	1	1	0	Variable			Bit Position	7	6	5	4	3	2	1	0	Access	r	r	r/w	r/w	r/w	r/w	r/w	r/w	Function	Mantissa								Default Value	Variable based on factory calibration								YES
Format	Linear, two's complement binary																																																																																			
Bit Position	15	14	13	12	11	10	9	8																																																																												
Access	r	r	r	r	r	r	r/w	r																																																																												
Function	Exponent				Mantissa																																																																															
Default Value	1	1	1	1	0	Variable																																																																														
Bit Position	7	6	5	4	3	2	1	0																																																																												
Access	r	r	r/w	r/w	r/w	r/w	r/w	r/w																																																																												
Function	Mantissa																																																																																			
Default Value	Variable based on factory calibration																																																																																			
40	VOUT_OV_FAULT_LIMIT	<p>Sets the voltage level for an output overvoltage fault. Implied exponent of -14 per VOUT_MODE command. Allowed range is 0.6 to 2V. Triggers SMBALERT.</p> <table border="1"> <tr> <td>Format</td> <td colspan="8">Linear, two's complement binary</td> </tr> <tr> <td>Bit Position</td> <td>15</td><td>14</td><td>13</td><td>12</td><td>11</td><td>10</td><td>9</td><td>8</td> </tr> <tr> <td>Access</td> <td>r/w</td><td>r/w</td><td>r/w</td><td>r/w</td><td>r/w</td><td>r/w</td><td>r/w</td><td>r/w</td> </tr> <tr> <td>Function</td> <td colspan="8">Mantissa</td> </tr> <tr> <td>Default Value</td> <td colspan="8">Variable</td> </tr> <tr> <td>Bit Position</td> <td>7</td><td>6</td><td>5</td><td>4</td><td>3</td><td>2</td><td>1</td><td>0</td> </tr> <tr> <td>Access</td> <td>r/w</td><td>r/w</td><td>r/w</td><td>r/w</td><td>r/w</td><td>r/w</td><td>r/w</td><td>r/w</td> </tr> <tr> <td>Function</td> <td colspan="8">Mantissa</td> </tr> <tr> <td>Default Value</td> <td colspan="8">Variable</td> </tr> </table>	Format	Linear, two's complement binary								Bit Position	15	14	13	12	11	10	9	8	Access	r/w	r/w	r/w	r/w	r/w	r/w	r/w	r/w	Function	Mantissa								Default Value	Variable								Bit Position	7	6	5	4	3	2	1	0	Access	r/w	r/w	r/w	r/w	r/w	r/w	r/w	r/w	Function	Mantissa								Default Value	Variable								YES
Format	Linear, two's complement binary																																																																																			
Bit Position	15	14	13	12	11	10	9	8																																																																												
Access	r/w	r/w	r/w	r/w	r/w	r/w	r/w	r/w																																																																												
Function	Mantissa																																																																																			
Default Value	Variable																																																																																			
Bit Position	7	6	5	4	3	2	1	0																																																																												
Access	r/w	r/w	r/w	r/w	r/w	r/w	r/w	r/w																																																																												
Function	Mantissa																																																																																			
Default Value	Variable																																																																																			
41	VOUT_OV_FAULT_RESPONSE	<p>Instructs the module on what action to take in response to an output overvoltage fault</p> <table border="1"> <tr> <td>Format</td> <td colspan="8">Unsigned Binary</td> </tr> <tr> <td>Bit Position</td> <td>7</td><td>6</td><td>5</td><td>4</td><td>3</td><td>2</td><td>1</td><td>0</td> </tr> <tr> <td>Access</td> <td>r/w</td><td>r/w</td><td>r/w</td><td>r/w</td><td>r/w</td><td>r</td><td>r</td><td>r</td> </tr> <tr> <td>Function</td> <td>RSP [1]</td><td>RSP [0]</td><td>RS[2]</td><td>RS[1]</td><td>RS[0]</td><td>X</td><td>X</td><td>X</td> </tr> <tr> <td>Default Value</td> <td>1</td><td>0</td><td>1</td><td>1</td><td>1</td><td>0</td><td>0</td><td>0</td> </tr> </table>	Format	Unsigned Binary								Bit Position	7	6	5	4	3	2	1	0	Access	r/w	r/w	r/w	r/w	r/w	r	r	r	Function	RSP [1]	RSP [0]	RS[2]	RS[1]	RS[0]	X	X	X	Default Value	1	0	1	1	1	0	0	0	YES																																				
Format	Unsigned Binary																																																																																			
Bit Position	7	6	5	4	3	2	1	0																																																																												
Access	r/w	r/w	r/w	r/w	r/w	r	r	r																																																																												
Function	RSP [1]	RSP [0]	RS[2]	RS[1]	RS[0]	X	X	X																																																																												
Default Value	1	0	1	1	1	0	0	0																																																																												

170A TeraDLynx™: Non-Isolated DC-DC Power Modules
 7Vdc -14Vdc input; 0.6Vdc to 1.5Vdc output; 170A Output Current

Table 4 (continued)

Hex Code	Command	Brief Description	Non-Volatile Memory Storage																																																																																						
42	VOUT_OV_WARN_LIMIT	<p>Sets the value of output voltage at which the module generates warning for over-voltage. Exponent is fixed at -14. Allowed range is 0.6 to 2V. Triggers SMBALERT.</p> <table border="1"> <tr> <td>Format</td> <td colspan="9">Linear, two's complement binary</td> </tr> <tr> <td>Bit Position</td> <td>15</td><td>14</td><td>13</td><td>12</td><td>11</td><td>10</td><td>9</td><td>8</td> </tr> <tr> <td>Access</td> <td>r</td><td>r</td><td>r</td><td>r</td><td>r</td><td>r/w</td><td>r/w</td><td>r/w</td> </tr> <tr> <td>Function</td> <td colspan="5">Exponent</td> <td colspan="4">Mantissa</td> </tr> <tr> <td>Default Value</td> <td colspan="9">Variable</td> </tr> <tr> <td>Bit Position</td> <td>7</td><td>6</td><td>5</td><td>4</td><td>3</td><td>2</td><td>1</td><td>0</td> </tr> <tr> <td>Access</td> <td>r/w</td><td>r/w</td><td>r/w</td><td>r/w</td><td>r/w</td><td>r/w</td><td>r/w</td><td>r/w</td> </tr> <tr> <td>Function</td> <td colspan="9">Mantissa</td> </tr> <tr> <td>Default Value</td> <td colspan="9">Variable</td> </tr> </table>	Format	Linear, two's complement binary									Bit Position	15	14	13	12	11	10	9	8	Access	r	r	r	r	r	r/w	r/w	r/w	Function	Exponent					Mantissa				Default Value	Variable									Bit Position	7	6	5	4	3	2	1	0	Access	r/w	r/w	r/w	r/w	r/w	r/w	r/w	r/w	Function	Mantissa									Default Value	Variable									YES
Format	Linear, two's complement binary																																																																																								
Bit Position	15	14	13	12	11	10	9	8																																																																																	
Access	r	r	r	r	r	r/w	r/w	r/w																																																																																	
Function	Exponent					Mantissa																																																																																			
Default Value	Variable																																																																																								
Bit Position	7	6	5	4	3	2	1	0																																																																																	
Access	r/w	r/w	r/w	r/w	r/w	r/w	r/w	r/w																																																																																	
Function	Mantissa																																																																																								
Default Value	Variable																																																																																								
43	VOUT_UV_WARN_LIMIT	<p>Sets the value of output voltage at which the module generates warning for under-voltage. Exponent is fixed at -14. Allowed range is 0.05 to 1.5V. Triggers SMBALERT.</p> <table border="1"> <tr> <td>Format</td> <td colspan="9">Linear, two's complement binary</td> </tr> <tr> <td>Bit Position</td> <td>15</td><td>14</td><td>13</td><td>12</td><td>11</td><td>10</td><td>9</td><td>8</td> </tr> <tr> <td>Access</td> <td>r</td><td>r</td><td>r</td><td>r</td><td>r</td><td>r/w</td><td>r/w</td><td>r/w</td> </tr> <tr> <td>Function</td> <td colspan="5">Exponent</td> <td colspan="4">Mantissa</td> </tr> <tr> <td>Default Value</td> <td colspan="9">Variable</td> </tr> <tr> <td>Bit Position</td> <td>7</td><td>6</td><td>5</td><td>4</td><td>3</td><td>2</td><td>1</td><td>0</td> </tr> <tr> <td>Access</td> <td>r/w</td><td>r/w</td><td>r/w</td><td>r/w</td><td>r/w</td><td>r/w</td><td>r/w</td><td>r/w</td> </tr> <tr> <td>Function</td> <td colspan="9">Mantissa</td> </tr> <tr> <td>Default Value</td> <td colspan="9">Variable</td> </tr> </table>	Format	Linear, two's complement binary									Bit Position	15	14	13	12	11	10	9	8	Access	r	r	r	r	r	r/w	r/w	r/w	Function	Exponent					Mantissa				Default Value	Variable									Bit Position	7	6	5	4	3	2	1	0	Access	r/w	r/w	r/w	r/w	r/w	r/w	r/w	r/w	Function	Mantissa									Default Value	Variable									YES
Format	Linear, two's complement binary																																																																																								
Bit Position	15	14	13	12	11	10	9	8																																																																																	
Access	r	r	r	r	r	r/w	r/w	r/w																																																																																	
Function	Exponent					Mantissa																																																																																			
Default Value	Variable																																																																																								
Bit Position	7	6	5	4	3	2	1	0																																																																																	
Access	r/w	r/w	r/w	r/w	r/w	r/w	r/w	r/w																																																																																	
Function	Mantissa																																																																																								
Default Value	Variable																																																																																								
44	VOUT_UV_FAULT_LIMIT	<p>Sets the voltage level for an output undervoltage fault. Exponent is fixed at -14. Allowed range is 0.05 to 2V. Triggers SMBALERT.</p> <table border="1"> <tr> <td>Format</td> <td colspan="9">Linear, two's complement binary</td> </tr> <tr> <td>Bit Position</td> <td>15</td><td>14</td><td>13</td><td>12</td><td>11</td><td>10</td><td>9</td><td>8</td> </tr> <tr> <td>Access</td> <td>r</td><td>r</td><td>r</td><td>r</td><td>r</td><td>r/w</td><td>r/w</td><td>r/w</td> </tr> <tr> <td>Function</td> <td colspan="5">Exponent</td> <td colspan="4">Mantissa</td> </tr> <tr> <td>Default Value</td> <td colspan="9">Variable</td> </tr> <tr> <td>Bit Position</td> <td>7</td><td>6</td><td>5</td><td>4</td><td>3</td><td>2</td><td>1</td><td>0</td> </tr> <tr> <td>Access</td> <td>r/w</td><td>r/w</td><td>r/w</td><td>r/w</td><td>r/w</td><td>r/w</td><td>r/w</td><td>r/w</td> </tr> <tr> <td>Function</td> <td colspan="9">Mantissa</td> </tr> <tr> <td>Default Value</td> <td colspan="9">Variable</td> </tr> </table>	Format	Linear, two's complement binary									Bit Position	15	14	13	12	11	10	9	8	Access	r	r	r	r	r	r/w	r/w	r/w	Function	Exponent					Mantissa				Default Value	Variable									Bit Position	7	6	5	4	3	2	1	0	Access	r/w	r/w	r/w	r/w	r/w	r/w	r/w	r/w	Function	Mantissa									Default Value	Variable									YES
Format	Linear, two's complement binary																																																																																								
Bit Position	15	14	13	12	11	10	9	8																																																																																	
Access	r	r	r	r	r	r/w	r/w	r/w																																																																																	
Function	Exponent					Mantissa																																																																																			
Default Value	Variable																																																																																								
Bit Position	7	6	5	4	3	2	1	0																																																																																	
Access	r/w	r/w	r/w	r/w	r/w	r/w	r/w	r/w																																																																																	
Function	Mantissa																																																																																								
Default Value	Variable																																																																																								
45	VOUT_UV_FAULT_RESPONSE	<p>Instructs the module on what action to take in response to an output undervoltage fault.</p> <table border="1"> <tr> <td>Format</td> <td colspan="9">Unsigned Binary</td> </tr> <tr> <td>Bit Position</td> <td>7</td><td>6</td><td>5</td><td>4</td><td>3</td><td>2</td><td>1</td><td>0</td> </tr> <tr> <td>Access</td> <td>r/w</td><td>r/w</td><td>r/w</td><td>r/w</td><td>r/w</td><td>r</td><td>r</td><td>r</td> </tr> <tr> <td>Function</td> <td>RSP [1]</td><td>RSP [0]</td><td>RS[2]</td><td>RS[1]</td><td>RS[0]</td><td>X</td><td>X</td><td>X</td> </tr> <tr> <td>Default Value</td> <td>1</td><td>0</td><td>1</td><td>1</td><td>1</td><td>0</td><td>0</td><td>0</td> </tr> </table>	Format	Unsigned Binary									Bit Position	7	6	5	4	3	2	1	0	Access	r/w	r/w	r/w	r/w	r/w	r	r	r	Function	RSP [1]	RSP [0]	RS[2]	RS[1]	RS[0]	X	X	X	Default Value	1	0	1	1	1	0	0	0	YES																																								
Format	Unsigned Binary																																																																																								
Bit Position	7	6	5	4	3	2	1	0																																																																																	
Access	r/w	r/w	r/w	r/w	r/w	r	r	r																																																																																	
Function	RSP [1]	RSP [0]	RS[2]	RS[1]	RS[0]	X	X	X																																																																																	
Default Value	1	0	1	1	1	0	0	0																																																																																	
46	IOUT_OC_FAULT_LIMIT	<p>Sets the current level for an output overcurrent fault (can only be lowered below the maximum of 185A). The exponent is fixed at -2. Triggers SMBALERT.</p> <table border="1"> <tr> <td>Format</td> <td colspan="9">Linear, two's complement binary</td> </tr> <tr> <td>Bit Position</td> <td>15</td><td>14</td><td>13</td><td>12</td><td>11</td><td>10</td><td>9</td><td>8</td> </tr> <tr> <td>Access</td> <td>r</td><td>r</td><td>r</td><td>r</td><td>r</td><td>r</td><td>r/w</td><td>r/w</td> </tr> <tr> <td>Function</td> <td colspan="5">Exponent</td> <td colspan="4">Mantissa</td> </tr> <tr> <td>Default Value</td> <td>1</td><td>1</td><td>1</td><td>1</td><td>0</td><td>0</td><td>1</td><td>0</td> </tr> <tr> <td>Bit Position</td> <td>7</td><td>6</td><td>5</td><td>4</td><td>3</td><td>2</td><td>1</td><td>0</td> </tr> <tr> <td>Access</td> <td>r/w</td><td>r/w</td><td>r/w</td><td>r/w</td><td>r/w</td><td>r/w</td><td>r/w</td><td>r/w</td> </tr> <tr> <td>Function</td> <td colspan="9">Mantissa</td> </tr> <tr> <td>Default Value</td> <td>1</td><td>1</td><td>1</td><td>0</td><td>0</td><td>1</td><td>0</td><td>0</td> </tr> </table>	Format	Linear, two's complement binary									Bit Position	15	14	13	12	11	10	9	8	Access	r	r	r	r	r	r	r/w	r/w	Function	Exponent					Mantissa				Default Value	1	1	1	1	0	0	1	0	Bit Position	7	6	5	4	3	2	1	0	Access	r/w	r/w	r/w	r/w	r/w	r/w	r/w	r/w	Function	Mantissa									Default Value	1	1	1	0	0	1	0	0	YES		
Format	Linear, two's complement binary																																																																																								
Bit Position	15	14	13	12	11	10	9	8																																																																																	
Access	r	r	r	r	r	r	r/w	r/w																																																																																	
Function	Exponent					Mantissa																																																																																			
Default Value	1	1	1	1	0	0	1	0																																																																																	
Bit Position	7	6	5	4	3	2	1	0																																																																																	
Access	r/w	r/w	r/w	r/w	r/w	r/w	r/w	r/w																																																																																	
Function	Mantissa																																																																																								
Default Value	1	1	1	0	0	1	0	0																																																																																	

170A TeraDLynx™: Non-Isolated DC-DC Power Modules
 7Vdc -14Vdc input; 0.6Vdc to 1.5Vdc output; 170A Output Current

Table 4 (continued)

Hex Code	Command	Brief Description	Non-Volatile Memory Storage																																																																																	
4A	IOUT_OC_WARN_LIMIT	<p>Sets the value of current level at which the module generates warning for overcurrent. Allowed range is 0 to 185A. The exponent is fixed at -2. Triggers SMBALERT.</p> <table border="1"> <tr> <td>Format</td> <td colspan="8">Linear, two's complement binary</td> </tr> <tr> <td>Bit Position</td> <td>15</td> <td>14</td> <td>13</td> <td>12</td> <td>11</td> <td>10</td> <td>9</td> <td>8</td> </tr> <tr> <td>Access</td> <td>r</td> <td>r</td> <td>r</td> <td>r</td> <td>r</td> <td>r</td> <td>r</td> <td>r/w</td> </tr> <tr> <td>Function</td> <td colspan="4">Exponent</td> <td colspan="4">Mantissa</td> </tr> <tr> <td>Default Value</td> <td>1</td> <td>1</td> <td>1</td> <td>1</td> <td>0</td> <td>0</td> <td>1</td> <td>0</td> </tr> <tr> <td>Bit Position</td> <td>7</td> <td>6</td> <td>5</td> <td>4</td> <td>3</td> <td>2</td> <td>1</td> <td>0</td> </tr> <tr> <td>Access</td> <td>r/w</td> <td>r/w</td> <td>r/w</td> <td>r/w</td> <td>r/w</td> <td>r/w</td> <td>r/w</td> <td>r/w</td> </tr> <tr> <td>Function</td> <td colspan="8">Mantissa</td> </tr> <tr> <td>Default Value</td> <td>1</td> <td>0</td> <td>1</td> <td>0</td> <td>1</td> <td>0</td> <td>0</td> <td>0</td> </tr> </table>	Format	Linear, two's complement binary								Bit Position	15	14	13	12	11	10	9	8	Access	r	r	r	r	r	r	r	r/w	Function	Exponent				Mantissa				Default Value	1	1	1	1	0	0	1	0	Bit Position	7	6	5	4	3	2	1	0	Access	r/w	r/w	r/w	r/w	r/w	r/w	r/w	r/w	Function	Mantissa								Default Value	1	0	1	0	1	0	0	0	YES
Format	Linear, two's complement binary																																																																																			
Bit Position	15	14	13	12	11	10	9	8																																																																												
Access	r	r	r	r	r	r	r	r/w																																																																												
Function	Exponent				Mantissa																																																																															
Default Value	1	1	1	1	0	0	1	0																																																																												
Bit Position	7	6	5	4	3	2	1	0																																																																												
Access	r/w	r/w	r/w	r/w	r/w	r/w	r/w	r/w																																																																												
Function	Mantissa																																																																																			
Default Value	1	0	1	0	1	0	0	0																																																																												
4F	OT_FAULT_LIMIT	<p>Sets the temperature level above which over-temperature fault occurs. Allowed range is 35 to 140°C. The exponent is fixed at 0. Triggers SMBALERT.</p> <table border="1"> <tr> <td>Format</td> <td colspan="8">Linear, two's complement binary</td> </tr> <tr> <td>Bit Position</td> <td>15</td> <td>14</td> <td>13</td> <td>12</td> <td>11</td> <td>10</td> <td>9</td> <td>8</td> </tr> <tr> <td>Access</td> <td>r</td> <td>r</td> <td>r</td> <td>r</td> <td>r</td> <td>r/w</td> <td>r</td> <td>r</td> </tr> <tr> <td>Function</td> <td colspan="4">Exponent</td> <td colspan="4">Mantissa</td> </tr> <tr> <td>Default Value</td> <td>0</td> <td>0</td> <td>0</td> <td>0</td> <td>0</td> <td>0</td> <td>0</td> <td>0</td> </tr> <tr> <td>Bit Position</td> <td>7</td> <td>6</td> <td>5</td> <td>4</td> <td>3</td> <td>2</td> <td>1</td> <td>0</td> </tr> <tr> <td>Access</td> <td>r/w</td> <td>r/w</td> <td>r/w</td> <td>r/w</td> <td>r/w</td> <td>r/w</td> <td>r/w</td> <td>r/w</td> </tr> <tr> <td>Function</td> <td colspan="8">Mantissa</td> </tr> <tr> <td>Default Value</td> <td>1</td> <td>0</td> <td>0</td> <td>0</td> <td>1</td> <td>0</td> <td>1</td> <td>0</td> </tr> </table>	Format	Linear, two's complement binary								Bit Position	15	14	13	12	11	10	9	8	Access	r	r	r	r	r	r/w	r	r	Function	Exponent				Mantissa				Default Value	0	0	0	0	0	0	0	0	Bit Position	7	6	5	4	3	2	1	0	Access	r/w	r/w	r/w	r/w	r/w	r/w	r/w	r/w	Function	Mantissa								Default Value	1	0	0	0	1	0	1	0	YES
Format	Linear, two's complement binary																																																																																			
Bit Position	15	14	13	12	11	10	9	8																																																																												
Access	r	r	r	r	r	r/w	r	r																																																																												
Function	Exponent				Mantissa																																																																															
Default Value	0	0	0	0	0	0	0	0																																																																												
Bit Position	7	6	5	4	3	2	1	0																																																																												
Access	r/w	r/w	r/w	r/w	r/w	r/w	r/w	r/w																																																																												
Function	Mantissa																																																																																			
Default Value	1	0	0	0	1	0	1	0																																																																												
50	OT_FAULT_RESPONSE	<p>Configures the over temperature fault response</p> <table border="1"> <tr> <td>Format</td> <td colspan="8">Unsigned Binary</td> </tr> <tr> <td>Bit Position</td> <td>7</td> <td>6</td> <td>5</td> <td>4</td> <td>3</td> <td>2</td> <td>1</td> <td>0</td> </tr> <tr> <td>Access</td> <td>r/w</td> <td>r/w</td> <td>r/w</td> <td>r/w</td> <td>r/w</td> <td>r</td> <td>r</td> <td>r</td> </tr> <tr> <td>Function</td> <td>RSP [1]</td> <td>RSP [0]</td> <td>RS[2]</td> <td>RS[1]</td> <td>RS[0]</td> <td>X</td> <td>X</td> <td>X</td> </tr> <tr> <td>Default Value</td> <td>1</td> <td>0</td> <td>1</td> <td>1</td> <td>1</td> <td>0</td> <td>0</td> <td>0</td> </tr> </table>	Format	Unsigned Binary								Bit Position	7	6	5	4	3	2	1	0	Access	r/w	r/w	r/w	r/w	r/w	r	r	r	Function	RSP [1]	RSP [0]	RS[2]	RS[1]	RS[0]	X	X	X	Default Value	1	0	1	1	1	0	0	0	YES																																				
Format	Unsigned Binary																																																																																			
Bit Position	7	6	5	4	3	2	1	0																																																																												
Access	r/w	r/w	r/w	r/w	r/w	r	r	r																																																																												
Function	RSP [1]	RSP [0]	RS[2]	RS[1]	RS[0]	X	X	X																																																																												
Default Value	1	0	1	1	1	0	0	0																																																																												
51	OT_WARN_LIMIT	<p>Sets the over temperature warning level in °C. Allowed range is 30 to 130°C. The exponent is fixed at 0. Valid values are from 30 - 130°C. Triggers SMBALERT.</p> <table border="1"> <tr> <td>Format</td> <td colspan="8">Linear, two's complement binary</td> </tr> <tr> <td>Bit Position</td> <td>15</td> <td>14</td> <td>13</td> <td>12</td> <td>11</td> <td>10</td> <td>9</td> <td>8</td> </tr> <tr> <td>Access</td> <td>r</td> <td>r</td> <td>r</td> <td>r</td> <td>r</td> <td>r</td> <td>r</td> <td>r</td> </tr> <tr> <td>Function</td> <td colspan="4">Exponent</td> <td colspan="4">Mantissa</td> </tr> <tr> <td>Default Value</td> <td>0</td> <td>0</td> <td>0</td> <td>0</td> <td>0</td> <td>0</td> <td>0</td> <td>0</td> </tr> <tr> <td>Bit Position</td> <td>7</td> <td>6</td> <td>5</td> <td>4</td> <td>3</td> <td>2</td> <td>1</td> <td>0</td> </tr> <tr> <td>Access</td> <td>r/w</td> <td>r/w</td> <td>r/w</td> <td>r/w</td> <td>r/w</td> <td>r/w</td> <td>r/w</td> <td>r/w</td> </tr> <tr> <td>Function</td> <td colspan="8">Mantissa</td> </tr> <tr> <td>Default Value</td> <td>0</td> <td>1</td> <td>1</td> <td>1</td> <td>1</td> <td>1</td> <td>0</td> <td>1</td> </tr> </table>	Format	Linear, two's complement binary								Bit Position	15	14	13	12	11	10	9	8	Access	r	r	r	r	r	r	r	r	Function	Exponent				Mantissa				Default Value	0	0	0	0	0	0	0	0	Bit Position	7	6	5	4	3	2	1	0	Access	r/w	r/w	r/w	r/w	r/w	r/w	r/w	r/w	Function	Mantissa								Default Value	0	1	1	1	1	1	0	1	YES
Format	Linear, two's complement binary																																																																																			
Bit Position	15	14	13	12	11	10	9	8																																																																												
Access	r	r	r	r	r	r	r	r																																																																												
Function	Exponent				Mantissa																																																																															
Default Value	0	0	0	0	0	0	0	0																																																																												
Bit Position	7	6	5	4	3	2	1	0																																																																												
Access	r/w	r/w	r/w	r/w	r/w	r/w	r/w	r/w																																																																												
Function	Mantissa																																																																																			
Default Value	0	1	1	1	1	1	0	1																																																																												
55	VIN_OV_FAULT_LIMIT	<p>Sets the input overvoltage fault limit. Exponent is fixed at -6. Allowed range is 6.75 to 15V. Triggers SMBALERT.</p> <table border="1"> <tr> <td>Format</td> <td colspan="8">Linear, two's complement binary.</td> </tr> <tr> <td>Bit Position</td> <td>15</td> <td>14</td> <td>13</td> <td>12tr</td> <td>11</td> <td>10</td> <td>9</td> <td>8</td> </tr> <tr> <td>Access</td> <td>r</td> <td>r</td> <td>r</td> <td>r</td> <td>r</td> <td>r</td> <td>r/w</td> <td>r/w</td> </tr> <tr> <td>Function</td> <td colspan="4">Exponent</td> <td colspan="4">Mantissa</td> </tr> <tr> <td>Default Value</td> <td>1</td> <td>1</td> <td>0</td> <td>1</td> <td>0</td> <td>0</td> <td>1</td> <td>1</td> </tr> <tr> <td>Bit Position</td> <td>7</td> <td>6</td> <td>5</td> <td>4</td> <td>3</td> <td>2</td> <td>1</td> <td>0</td> </tr> <tr> <td>Access</td> <td>r/w</td> <td>r/w</td> <td>r/w</td> <td>r/w</td> <td>r/w</td> <td>r/w</td> <td>r/w</td> <td>r/w</td> </tr> <tr> <td>Function</td> <td colspan="8">Mantissa</td> </tr> <tr> <td>Default Value</td> <td>1</td> <td>0</td> <td>1</td> <td>0</td> <td>0</td> <td>0</td> <td>0</td> <td>0</td> </tr> </table>	Format	Linear, two's complement binary.								Bit Position	15	14	13	12tr	11	10	9	8	Access	r	r	r	r	r	r	r/w	r/w	Function	Exponent				Mantissa				Default Value	1	1	0	1	0	0	1	1	Bit Position	7	6	5	4	3	2	1	0	Access	r/w	r/w	r/w	r/w	r/w	r/w	r/w	r/w	Function	Mantissa								Default Value	1	0	1	0	0	0	0	0	YES
Format	Linear, two's complement binary.																																																																																			
Bit Position	15	14	13	12tr	11	10	9	8																																																																												
Access	r	r	r	r	r	r	r/w	r/w																																																																												
Function	Exponent				Mantissa																																																																															
Default Value	1	1	0	1	0	0	1	1																																																																												
Bit Position	7	6	5	4	3	2	1	0																																																																												
Access	r/w	r/w	r/w	r/w	r/w	r/w	r/w	r/w																																																																												
Function	Mantissa																																																																																			
Default Value	1	0	1	0	0	0	0	0																																																																												

170A TeraDlynx™: Non-Isolated DC-DC Power Modules
 7Vdc -14Vdc input; 0.6Vdc to 1.5Vdc output; 170A Output Current

Table 4 (continued)

Hex Code	Command	Brief Description	Non-Volatile Memory Storage																																																																																	
56	VIN_OV_FAULT_RESPONSE	<p>Configures the VIN overvoltage fault response.</p> <table border="1"> <tr> <td>Format</td> <td colspan="8">Unsigned Binary</td> </tr> <tr> <td>Bit Position</td> <td>7</td> <td>6</td> <td>5</td> <td>4</td> <td>3</td> <td>2</td> <td>1</td> <td>0</td> </tr> <tr> <td>Access</td> <td>r/w</td> <td>r/w</td> <td>r/w</td> <td>r/w</td> <td>r/w</td> <td>r</td> <td>r</td> <td>r</td> </tr> <tr> <td>Function</td> <td>RSP [1]</td> <td>RSP [0]</td> <td>RS[2]</td> <td>RS[1]</td> <td>RS[0]</td> <td>X</td> <td>X</td> <td>X</td> </tr> <tr> <td>Default Value</td> <td>1</td> <td>0</td> <td>0</td> <td>0</td> <td>0</td> <td>0</td> <td>0</td> <td>0</td> </tr> </table>	Format	Unsigned Binary								Bit Position	7	6	5	4	3	2	1	0	Access	r/w	r/w	r/w	r/w	r/w	r	r	r	Function	RSP [1]	RSP [0]	RS[2]	RS[1]	RS[0]	X	X	X	Default Value	1	0	0	0	0	0	0	0	YES																																				
Format	Unsigned Binary																																																																																			
Bit Position	7	6	5	4	3	2	1	0																																																																												
Access	r/w	r/w	r/w	r/w	r/w	r	r	r																																																																												
Function	RSP [1]	RSP [0]	RS[2]	RS[1]	RS[0]	X	X	X																																																																												
Default Value	1	0	0	0	0	0	0	0																																																																												
57	VIN_OV_WARN_LIMIT	<p>Sets the value of the input voltage that causes input voltage low warning. Exponent fixed at -6. Allowed range is 6.75 to 15V. Triggers SMBALERT.</p> <table border="1"> <tr> <td>Format</td> <td colspan="8">Linear, two's complement binary</td> </tr> <tr> <td>Bit Position</td> <td>15</td> <td>14</td> <td>13</td> <td>12</td> <td>11</td> <td>10</td> <td>9</td> <td>8</td> </tr> <tr> <td>Access</td> <td>r</td> <td>r</td> <td>r</td> <td>r</td> <td>r</td> <td>r</td> <td>r/w</td> <td>r/w</td> </tr> <tr> <td>Function</td> <td colspan="4">Exponent</td> <td colspan="4">Mantissa</td> </tr> <tr> <td>Default Value</td> <td>1</td> <td>1</td> <td>0</td> <td>1</td> <td>0</td> <td>0</td> <td>1</td> <td>1</td> </tr> <tr> <td>Bit Position</td> <td>7</td> <td>6</td> <td>5</td> <td>4</td> <td>3</td> <td>2</td> <td>1</td> <td>0</td> </tr> <tr> <td>Access</td> <td>r/w</td> <td>r/w</td> <td>r/w</td> <td>r/w</td> <td>r/w</td> <td>r/w</td> <td>r/w</td> <td>r/w</td> </tr> <tr> <td>Function</td> <td colspan="8">Mantissa</td> </tr> <tr> <td>Default Value</td> <td>1</td> <td>0</td> <td>0</td> <td>0</td> <td>0</td> <td>0</td> <td>0</td> <td>0</td> </tr> </table>	Format	Linear, two's complement binary								Bit Position	15	14	13	12	11	10	9	8	Access	r	r	r	r	r	r	r/w	r/w	Function	Exponent				Mantissa				Default Value	1	1	0	1	0	0	1	1	Bit Position	7	6	5	4	3	2	1	0	Access	r/w	r/w	r/w	r/w	r/w	r/w	r/w	r/w	Function	Mantissa								Default Value	1	0	0	0	0	0	0	0	YES
Format	Linear, two's complement binary																																																																																			
Bit Position	15	14	13	12	11	10	9	8																																																																												
Access	r	r	r	r	r	r	r/w	r/w																																																																												
Function	Exponent				Mantissa																																																																															
Default Value	1	1	0	1	0	0	1	1																																																																												
Bit Position	7	6	5	4	3	2	1	0																																																																												
Access	r/w	r/w	r/w	r/w	r/w	r/w	r/w	r/w																																																																												
Function	Mantissa																																																																																			
Default Value	1	0	0	0	0	0	0	0																																																																												
58	VIN_UV_WARN_LIMIT	<p>Sets the value of the input voltage that causes input voltage low warning. Exponent fixed at -6. Allowed range is 5 to 14V. Triggers SMBALERT.</p> <table border="1"> <tr> <td>Format</td> <td colspan="8">Linear, two's complement binary</td> </tr> <tr> <td>Bit Position</td> <td>15</td> <td>14</td> <td>13</td> <td>12</td> <td>11</td> <td>10</td> <td>9</td> <td>8</td> </tr> <tr> <td>Access</td> <td>r</td> <td>r</td> <td>r</td> <td>r</td> <td>r</td> <td>r</td> <td>r/w</td> <td>r/w</td> </tr> <tr> <td>Function</td> <td colspan="4">Exponent</td> <td colspan="4">Mantissa</td> </tr> <tr> <td>Default Value</td> <td>1</td> <td>1</td> <td>0</td> <td>1</td> <td>0</td> <td>0</td> <td>0</td> <td>1</td> </tr> <tr> <td>Bit Position</td> <td>7</td> <td>6</td> <td>5</td> <td>4</td> <td>3</td> <td>2</td> <td>1</td> <td>0</td> </tr> <tr> <td>Access</td> <td>r/w</td> <td>r/w</td> <td>r/w</td> <td>r/w</td> <td>r/w</td> <td>r/w</td> <td>r/w</td> <td>r/w</td> </tr> <tr> <td>Function</td> <td colspan="8">Mantissa</td> </tr> <tr> <td>Default Value</td> <td>1</td> <td>0</td> <td>1</td> <td>0</td> <td>0</td> <td>0</td> <td>0</td> <td>0</td> </tr> </table>	Format	Linear, two's complement binary								Bit Position	15	14	13	12	11	10	9	8	Access	r	r	r	r	r	r	r/w	r/w	Function	Exponent				Mantissa				Default Value	1	1	0	1	0	0	0	1	Bit Position	7	6	5	4	3	2	1	0	Access	r/w	r/w	r/w	r/w	r/w	r/w	r/w	r/w	Function	Mantissa								Default Value	1	0	1	0	0	0	0	0	YES
Format	Linear, two's complement binary																																																																																			
Bit Position	15	14	13	12	11	10	9	8																																																																												
Access	r	r	r	r	r	r	r/w	r/w																																																																												
Function	Exponent				Mantissa																																																																															
Default Value	1	1	0	1	0	0	0	1																																																																												
Bit Position	7	6	5	4	3	2	1	0																																																																												
Access	r/w	r/w	r/w	r/w	r/w	r/w	r/w	r/w																																																																												
Function	Mantissa																																																																																			
Default Value	1	0	1	0	0	0	0	0																																																																												
59	VIN_UV_FAULT_LIMIT	<p>Sets the value of the input voltage that causes an input undervoltage fault. Exponent fixed at -6. Allowed range is 5 to 14V. Triggers SMBALERT.</p> <table border="1"> <tr> <td>Format</td> <td colspan="8">Linear, two's complement binary</td> </tr> <tr> <td>Bit Position</td> <td>7</td> <td>6</td> <td>5</td> <td>4</td> <td>3</td> <td>2</td> <td>1</td> <td>0</td> </tr> <tr> <td>Access</td> <td>r</td> <td>r</td> <td>r</td> <td>r</td> <td>r</td> <td>r</td> <td>r/w</td> <td>r/w</td> </tr> <tr> <td>Function</td> <td colspan="4">Exponent</td> <td colspan="4">Mantissa</td> </tr> <tr> <td>Default Value</td> <td>1</td> <td>1</td> <td>0</td> <td>1</td> <td>0</td> <td>0</td> <td>0</td> <td>1</td> </tr> <tr> <td>Bit Position</td> <td>7</td> <td>6</td> <td>5</td> <td>4</td> <td>3</td> <td>2</td> <td>1</td> <td>0</td> </tr> <tr> <td>Access</td> <td>r/w</td> <td>r/w</td> <td>r/w</td> <td>r/w</td> <td>r/w</td> <td>r/w</td> <td>r/w</td> <td>r/w</td> </tr> <tr> <td>Function</td> <td colspan="8">Mantissa</td> </tr> <tr> <td>Default Value</td> <td>1</td> <td>0</td> <td>1</td> <td>0</td> <td>0</td> <td>0</td> <td>0</td> <td>0</td> </tr> </table>	Format	Linear, two's complement binary								Bit Position	7	6	5	4	3	2	1	0	Access	r	r	r	r	r	r	r/w	r/w	Function	Exponent				Mantissa				Default Value	1	1	0	1	0	0	0	1	Bit Position	7	6	5	4	3	2	1	0	Access	r/w	r/w	r/w	r/w	r/w	r/w	r/w	r/w	Function	Mantissa								Default Value	1	0	1	0	0	0	0	0	YES
Format	Linear, two's complement binary																																																																																			
Bit Position	7	6	5	4	3	2	1	0																																																																												
Access	r	r	r	r	r	r	r/w	r/w																																																																												
Function	Exponent				Mantissa																																																																															
Default Value	1	1	0	1	0	0	0	1																																																																												
Bit Position	7	6	5	4	3	2	1	0																																																																												
Access	r/w	r/w	r/w	r/w	r/w	r/w	r/w	r/w																																																																												
Function	Mantissa																																																																																			
Default Value	1	0	1	0	0	0	0	0																																																																												
5A	VIN_UV_FAULT_RESPONSE	<p>Instructs the module on what action to take in response to an input undervoltage fault.</p> <table border="1"> <tr> <td>Format</td> <td colspan="8">Unsigned Binary</td> </tr> <tr> <td>Bit Position</td> <td>7</td> <td>6</td> <td>5</td> <td>4</td> <td>3</td> <td>2</td> <td>1</td> <td>0</td> </tr> <tr> <td>Access</td> <td>r/w</td> <td>r/w</td> <td>r/w</td> <td>r/w</td> <td>r/w</td> <td>r</td> <td>r</td> <td>r</td> </tr> <tr> <td>Function</td> <td>RSP [1]</td> <td>RSP [0]</td> <td>RS[2]</td> <td>RS[1]</td> <td>RS[0]</td> <td>X</td> <td>X</td> <td>X</td> </tr> <tr> <td>Default Value</td> <td>1</td> <td>0</td> <td>1</td> <td>1</td> <td>1</td> <td>0</td> <td>0</td> <td>0</td> </tr> </table>	Format	Unsigned Binary								Bit Position	7	6	5	4	3	2	1	0	Access	r/w	r/w	r/w	r/w	r/w	r	r	r	Function	RSP [1]	RSP [0]	RS[2]	RS[1]	RS[0]	X	X	X	Default Value	1	0	1	1	1	0	0	0	YES																																				
Format	Unsigned Binary																																																																																			
Bit Position	7	6	5	4	3	2	1	0																																																																												
Access	r/w	r/w	r/w	r/w	r/w	r	r	r																																																																												
Function	RSP [1]	RSP [0]	RS[2]	RS[1]	RS[0]	X	X	X																																																																												
Default Value	1	0	1	1	1	0	0	0																																																																												
5E	POWER_GOOD_ON	<p>Sets the output voltage level at which the PGOOD pin is asserted high. Implied exponent of -14 per VOUT_MODE command. Allowed range is 0.26 to 1.65V.</p> <table border="1"> <tr> <td>Format</td> <td colspan="8">Linear, two's complement binary</td> </tr> <tr> <td>Bit Position</td> <td>15</td> <td>14</td> <td>13</td> <td>12</td> <td>11</td> <td>10</td> <td>9</td> <td>8</td> </tr> <tr> <td>Access</td> <td>r</td> <td>r/w</td> <td>r/w</td> <td>r/w</td> <td>r/w</td> <td>r/w</td> <td>r/w</td> <td>r/w</td> </tr> <tr> <td>Function</td> <td colspan="8">Mantissa</td> </tr> <tr> <td>Default Value</td> <td colspan="8">Variable</td> </tr> <tr> <td>Bit Position</td> <td>7</td> <td>6</td> <td>5</td> <td>4</td> <td>3</td> <td>2</td> <td>1</td> <td>0</td> </tr> <tr> <td>Access</td> <td>r/w</td> <td>r/w</td> <td>r/w</td> <td>r/w</td> <td>r/w</td> <td>r/w</td> <td>r/w</td> <td>r/w</td> </tr> <tr> <td>Function</td> <td colspan="8">Mantissa</td> </tr> <tr> <td>Default Value</td> <td colspan="8">Variable</td> </tr> </table>	Format	Linear, two's complement binary								Bit Position	15	14	13	12	11	10	9	8	Access	r	r/w	r/w	r/w	r/w	r/w	r/w	r/w	Function	Mantissa								Default Value	Variable								Bit Position	7	6	5	4	3	2	1	0	Access	r/w	r/w	r/w	r/w	r/w	r/w	r/w	r/w	Function	Mantissa								Default Value	Variable								YES
Format	Linear, two's complement binary																																																																																			
Bit Position	15	14	13	12	11	10	9	8																																																																												
Access	r	r/w	r/w	r/w	r/w	r/w	r/w	r/w																																																																												
Function	Mantissa																																																																																			
Default Value	Variable																																																																																			
Bit Position	7	6	5	4	3	2	1	0																																																																												
Access	r/w	r/w	r/w	r/w	r/w	r/w	r/w	r/w																																																																												
Function	Mantissa																																																																																			
Default Value	Variable																																																																																			

170A TeraDlynx™: Non-Isolated DC-DC Power Modules
 7Vdc -14Vdc input; 0.6Vdc to 1.5Vdc output; 170A Output Current

Table 4 (continued)

Hex Code	Command	Brief Description	Non-Volatile Memory Storage																																																																																										
5F	POWER_GOOD_OFF	<p>Sets the output voltage level at which the PGOOD pin is de-asserted low. Implied exponent of -14 per VOUT_MODE command. Allowed range is 0.06 to 1.63V.</p> <table border="1"> <tr> <td>Format</td> <td colspan="9">Linear, two's complement binary</td> </tr> <tr> <td>Bit Position</td> <td>15</td><td>14</td><td>13</td><td>12</td><td>11</td><td>10</td><td>9</td><td>8</td><td></td> </tr> <tr> <td>Access</td> <td>r</td><td>r/w</td><td>r/w</td><td>r/w</td><td>r/w</td><td>r/w</td><td>r/w</td><td>r/w</td><td>r/w</td> </tr> <tr> <td>Function</td> <td colspan="9">Mantissa</td> </tr> <tr> <td>Default Value</td> <td colspan="9">Variable</td> </tr> <tr> <td>Bit Position</td> <td>7</td><td>6</td><td>5</td><td>4</td><td>3</td><td>2</td><td>1</td><td>0</td><td></td> </tr> <tr> <td>Access</td> <td>r/w</td><td>r/w</td><td>r/w</td><td>r/w</td><td>r/w</td><td>r/w</td><td>r/w</td><td>r/w</td><td>r/w</td> </tr> <tr> <td>Function</td> <td colspan="9">Mantissa</td> </tr> <tr> <td>Default Value</td> <td colspan="9">Variable</td> </tr> </table>	Format	Linear, two's complement binary									Bit Position	15	14	13	12	11	10	9	8		Access	r	r/w	r/w	r/w	r/w	r/w	r/w	r/w	r/w	Function	Mantissa									Default Value	Variable									Bit Position	7	6	5	4	3	2	1	0		Access	r/w	r/w	r/w	r/w	r/w	r/w	r/w	r/w	r/w	Function	Mantissa									Default Value	Variable									YES
Format	Linear, two's complement binary																																																																																												
Bit Position	15	14	13	12	11	10	9	8																																																																																					
Access	r	r/w	r/w	r/w	r/w	r/w	r/w	r/w	r/w																																																																																				
Function	Mantissa																																																																																												
Default Value	Variable																																																																																												
Bit Position	7	6	5	4	3	2	1	0																																																																																					
Access	r/w	r/w	r/w	r/w	r/w	r/w	r/w	r/w	r/w																																																																																				
Function	Mantissa																																																																																												
Default Value	Variable																																																																																												
60	TON_DELAY	<p>Sets the delay time in ms of the output voltage during startup. Allowed range is 0 to 1000ms.</p> <table border="1"> <tr> <td>Format</td> <td colspan="9">Linear, two's complement binary</td> </tr> <tr> <td>Bit Position</td> <td>15</td><td>14</td><td>13</td><td>12</td><td>11</td><td>10</td><td>9</td><td>8</td><td></td> </tr> <tr> <td>Access</td> <td>r</td><td>r</td><td>r</td><td>r</td><td>r</td><td>r</td><td>r/w</td><td>r/w</td><td></td> </tr> <tr> <td>Function</td> <td colspan="5">Exponent</td> <td colspan="4">Mantissa</td> </tr> <tr> <td>Default Value</td> <td>0</td><td>0</td><td>0</td><td>0</td><td>0</td><td>0</td><td>0</td><td>0</td><td></td> </tr> <tr> <td>Bit Position</td> <td>7</td><td>6</td><td>5</td><td>4</td><td>3</td><td>2</td><td>1</td><td>0</td><td></td> </tr> <tr> <td>Access</td> <td>r/w</td><td>r/w</td><td>r/w</td><td>r/w</td><td>r/w</td><td>r/w</td><td>r/w</td><td>r/w</td><td>r/w</td> </tr> <tr> <td>Function</td> <td colspan="9">Mantissa</td> </tr> <tr> <td>Default Value</td> <td>0</td><td>0</td><td>0</td><td>0</td><td>0</td><td>0</td><td>1</td><td>0</td><td></td> </tr> </table>	Format	Linear, two's complement binary									Bit Position	15	14	13	12	11	10	9	8		Access	r	r	r	r	r	r	r/w	r/w		Function	Exponent					Mantissa				Default Value	0	0	0	0	0	0	0	0		Bit Position	7	6	5	4	3	2	1	0		Access	r/w	r/w	r/w	r/w	r/w	r/w	r/w	r/w	r/w	Function	Mantissa									Default Value	0	0	0	0	0	0	1	0		YES
Format	Linear, two's complement binary																																																																																												
Bit Position	15	14	13	12	11	10	9	8																																																																																					
Access	r	r	r	r	r	r	r/w	r/w																																																																																					
Function	Exponent					Mantissa																																																																																							
Default Value	0	0	0	0	0	0	0	0																																																																																					
Bit Position	7	6	5	4	3	2	1	0																																																																																					
Access	r/w	r/w	r/w	r/w	r/w	r/w	r/w	r/w	r/w																																																																																				
Function	Mantissa																																																																																												
Default Value	0	0	0	0	0	0	1	0																																																																																					
61	TON_RISE	<p>Sets the rise time in ms of the output voltage during startup. The exponent is fixed at 0. Allowed range is 1 to 1000ms.</p> <table border="1"> <tr> <td>Format</td> <td colspan="9">Linear, two's complement binary</td> </tr> <tr> <td>Bit Position</td> <td>7</td><td>6</td><td>5</td><td>4</td><td>3</td><td>2</td><td>1</td><td>0</td><td></td> </tr> <tr> <td>Access</td> <td>r</td><td>r</td><td>R</td><td>r</td><td>r</td><td>r</td><td>r/w</td><td>r/w</td><td></td> </tr> <tr> <td>Function</td> <td colspan="5">Exponent</td> <td colspan="4">Mantissa</td> </tr> <tr> <td>Default Value</td> <td>0</td><td>0</td><td>0</td><td>0</td><td>0</td><td>0</td><td>0</td><td>0</td><td></td> </tr> <tr> <td>Bit Position</td> <td>7</td><td>6</td><td>5</td><td>4</td><td>3</td><td>2</td><td>1</td><td>0</td><td></td> </tr> <tr> <td>Access</td> <td>r/w</td><td>r/w</td><td>r/w</td><td>r/w</td><td>r/w</td><td>r/w</td><td>r/w</td><td>r/w</td><td>r/w</td> </tr> <tr> <td>Function</td> <td colspan="9">Mantissa</td> </tr> <tr> <td>Default Value</td> <td>0</td><td>0</td><td>0</td><td>0</td><td>0</td><td>1</td><td>0</td><td>1</td><td></td> </tr> </table>	Format	Linear, two's complement binary									Bit Position	7	6	5	4	3	2	1	0		Access	r	r	R	r	r	r	r/w	r/w		Function	Exponent					Mantissa				Default Value	0	0	0	0	0	0	0	0		Bit Position	7	6	5	4	3	2	1	0		Access	r/w	r/w	r/w	r/w	r/w	r/w	r/w	r/w	r/w	Function	Mantissa									Default Value	0	0	0	0	0	1	0	1		YES
Format	Linear, two's complement binary																																																																																												
Bit Position	7	6	5	4	3	2	1	0																																																																																					
Access	r	r	R	r	r	r	r/w	r/w																																																																																					
Function	Exponent					Mantissa																																																																																							
Default Value	0	0	0	0	0	0	0	0																																																																																					
Bit Position	7	6	5	4	3	2	1	0																																																																																					
Access	r/w	r/w	r/w	r/w	r/w	r/w	r/w	r/w	r/w																																																																																				
Function	Mantissa																																																																																												
Default Value	0	0	0	0	0	1	0	1																																																																																					
64	TOFF_DELAY	<p>Sets the delay time in ms of the output voltage during turn-off. The exponent is fixed at 0. Allowed range is 0 to 1000ms.</p> <table border="1"> <tr> <td>Format</td> <td colspan="9">Linear, two's complement binary</td> </tr> <tr> <td>Bit Position</td> <td>15</td><td>14</td><td>13</td><td>12</td><td>11</td><td>10</td><td>9</td><td>8</td><td></td> </tr> <tr> <td>Access</td> <td>r</td><td>r</td><td>R</td><td>r</td><td>r</td><td>r</td><td>r/w</td><td>r/w</td><td></td> </tr> <tr> <td>Function</td> <td colspan="5">Exponent</td> <td colspan="4">Mantissa</td> </tr> <tr> <td>Default Value</td> <td>0</td><td>0</td><td>0</td><td>0</td><td>0</td><td>0</td><td>0</td><td>0</td><td></td> </tr> <tr> <td>Bit Position</td> <td>7</td><td>6</td><td>5</td><td>4</td><td>3</td><td>2</td><td>1</td><td>0</td><td></td> </tr> <tr> <td>Access</td> <td>r/w</td><td>r/w</td><td>r/w</td><td>r/w</td><td>r/w</td><td>r/w</td><td>r/w</td><td>r/w</td><td>r/w</td> </tr> <tr> <td>Function</td> <td colspan="9">Mantissa</td> </tr> <tr> <td>Default Value</td> <td>0</td><td>0</td><td>0</td><td>0</td><td>0</td><td>0</td><td>1</td><td>0</td><td></td> </tr> </table>	Format	Linear, two's complement binary									Bit Position	15	14	13	12	11	10	9	8		Access	r	r	R	r	r	r	r/w	r/w		Function	Exponent					Mantissa				Default Value	0	0	0	0	0	0	0	0		Bit Position	7	6	5	4	3	2	1	0		Access	r/w	r/w	r/w	r/w	r/w	r/w	r/w	r/w	r/w	Function	Mantissa									Default Value	0	0	0	0	0	0	1	0		YES
Format	Linear, two's complement binary																																																																																												
Bit Position	15	14	13	12	11	10	9	8																																																																																					
Access	r	r	R	r	r	r	r/w	r/w																																																																																					
Function	Exponent					Mantissa																																																																																							
Default Value	0	0	0	0	0	0	0	0																																																																																					
Bit Position	7	6	5	4	3	2	1	0																																																																																					
Access	r/w	r/w	r/w	r/w	r/w	r/w	r/w	r/w	r/w																																																																																				
Function	Mantissa																																																																																												
Default Value	0	0	0	0	0	0	1	0																																																																																					
65	TOFF_FALL	<p>Sets the fall time in ms of the output voltage during turn-off. Exponent is fixed at 0. Allowed range is 0 to 1000ms.</p> <table border="1"> <tr> <td>Format</td> <td colspan="9">Linear, two's complement binary</td> </tr> <tr> <td>Bit Position</td> <td>15</td><td>14</td><td>13</td><td>12</td><td>11</td><td>10</td><td>9</td><td>8</td><td></td> </tr> <tr> <td>Access</td> <td>r</td><td>r</td><td>R</td><td>r</td><td>r</td><td>r</td><td>r/w</td><td>r/w</td><td></td> </tr> <tr> <td>Function</td> <td colspan="5">Exponent</td> <td colspan="4">Mantissa</td> </tr> <tr> <td>Default Value</td> <td>0</td><td>0</td><td>0</td><td>0</td><td>0</td><td>0</td><td>0</td><td>0</td><td></td> </tr> <tr> <td>Bit Position</td> <td>7</td><td>6</td><td>5</td><td>4</td><td>3</td><td>2</td><td>1</td><td>0</td><td></td> </tr> <tr> <td>Access</td> <td>r/w</td><td>r/w</td><td>r/w</td><td>r/w</td><td>r/w</td><td>r/w</td><td>r/w</td><td>r/w</td><td>r/w</td> </tr> <tr> <td>Function</td> <td colspan="9">Mantissa</td> </tr> <tr> <td>Default Value</td> <td>0</td><td>0</td><td>0</td><td>0</td><td>0</td><td>1</td><td>0</td><td>1</td><td></td> </tr> </table>	Format	Linear, two's complement binary									Bit Position	15	14	13	12	11	10	9	8		Access	r	r	R	r	r	r	r/w	r/w		Function	Exponent					Mantissa				Default Value	0	0	0	0	0	0	0	0		Bit Position	7	6	5	4	3	2	1	0		Access	r/w	r/w	r/w	r/w	r/w	r/w	r/w	r/w	r/w	Function	Mantissa									Default Value	0	0	0	0	0	1	0	1		YES
Format	Linear, two's complement binary																																																																																												
Bit Position	15	14	13	12	11	10	9	8																																																																																					
Access	r	r	R	r	r	r	r/w	r/w																																																																																					
Function	Exponent					Mantissa																																																																																							
Default Value	0	0	0	0	0	0	0	0																																																																																					
Bit Position	7	6	5	4	3	2	1	0																																																																																					
Access	r/w	r/w	r/w	r/w	r/w	r/w	r/w	r/w	r/w																																																																																				
Function	Mantissa																																																																																												
Default Value	0	0	0	0	0	1	0	1																																																																																					

170A TeraDlynx™: Non-Isolated DC-DC Power Modules

7Vdc –14Vdc input; 0.6Vdc to 1.5Vdc output; 170A Output Current

Table 4 (Continued)

Hex Code	Command	Brief Description	Non-Volatile Memory Storage																																																																																	
78	STATUS_BYTE	<p>Returns one byte of information with a summary of the most critical module faults</p> <table border="1"> <tr> <td>Format</td> <td colspan="8">Unsigned Binary</td> </tr> <tr> <td>Bit Position</td> <td>7</td> <td>6</td> <td>5</td> <td>4</td> <td>3</td> <td>2</td> <td>1</td> <td>0</td> </tr> <tr> <td>Access</td> <td>r</td> <td>r</td> <td>R</td> <td>r</td> <td>r</td> <td>r</td> <td>r</td> <td>r</td> </tr> <tr> <td>Flag</td> <td>X</td> <td>OFF</td> <td>VOUT_OV</td> <td>IOUT_OC</td> <td>VIN_UV</td> <td>TEMP</td> <td>CML</td> <td>OTHER</td> </tr> <tr> <td>Default Value</td> <td colspan="8">Variable</td> </tr> </table>	Format	Unsigned Binary								Bit Position	7	6	5	4	3	2	1	0	Access	r	r	R	r	r	r	r	r	Flag	X	OFF	VOUT_OV	IOUT_OC	VIN_UV	TEMP	CML	OTHER	Default Value	Variable																																												
Format	Unsigned Binary																																																																																			
Bit Position	7	6	5	4	3	2	1	0																																																																												
Access	r	r	R	r	r	r	r	r																																																																												
Flag	X	OFF	VOUT_OV	IOUT_OC	VIN_UV	TEMP	CML	OTHER																																																																												
Default Value	Variable																																																																																			
79	STATUS_WORD	<p>Returns two bytes of information with a summary of the module's fault/warning conditions</p> <table border="1"> <tr> <td>Format</td> <td colspan="8">Unsigned binary</td> </tr> <tr> <td>Bit Position</td> <td>15</td> <td>14</td> <td>13</td> <td>12</td> <td>11</td> <td>10</td> <td>9</td> <td>8</td> </tr> <tr> <td>Access</td> <td>r</td> <td>r</td> <td>R</td> <td>r</td> <td>r</td> <td>r</td> <td>r</td> <td>r</td> </tr> <tr> <td>Flag</td> <td>VOUT</td> <td>IOUT_OC</td> <td>INPUT</td> <td>X</td> <td>PGOOD</td> <td>X</td> <td>X</td> <td>X</td> </tr> <tr> <td>Default Value</td> <td colspan="8">Variable</td> </tr> <tr> <td>Bit Position</td> <td>7</td> <td>6</td> <td>5</td> <td>4</td> <td>3</td> <td>2</td> <td>1</td> <td>0</td> </tr> <tr> <td>Access</td> <td>r</td> <td>r</td> <td>R</td> <td>r</td> <td>r</td> <td>r</td> <td>r</td> <td>r</td> </tr> <tr> <td>Flag</td> <td>X</td> <td>OFF</td> <td>VOUT_OV</td> <td>IOUT_OC</td> <td>VIN_UV</td> <td>TEMP</td> <td>CML</td> <td>OTHER</td> </tr> <tr> <td>Default Value</td> <td colspan="8">Variable</td> </tr> </table>	Format	Unsigned binary								Bit Position	15	14	13	12	11	10	9	8	Access	r	r	R	r	r	r	r	r	Flag	VOUT	IOUT_OC	INPUT	X	PGOOD	X	X	X	Default Value	Variable								Bit Position	7	6	5	4	3	2	1	0	Access	r	r	R	r	r	r	r	r	Flag	X	OFF	VOUT_OV	IOUT_OC	VIN_UV	TEMP	CML	OTHER	Default Value	Variable								
Format	Unsigned binary																																																																																			
Bit Position	15	14	13	12	11	10	9	8																																																																												
Access	r	r	R	r	r	r	r	r																																																																												
Flag	VOUT	IOUT_OC	INPUT	X	PGOOD	X	X	X																																																																												
Default Value	Variable																																																																																			
Bit Position	7	6	5	4	3	2	1	0																																																																												
Access	r	r	R	r	r	r	r	r																																																																												
Flag	X	OFF	VOUT_OV	IOUT_OC	VIN_UV	TEMP	CML	OTHER																																																																												
Default Value	Variable																																																																																			
7A	STATUS_VOUT	<p>Returns one byte of information with the status of the module's output voltage related faults</p> <table border="1"> <tr> <td>Format</td> <td colspan="8">Unsigned Binary</td> </tr> <tr> <td>Bit Position</td> <td>7</td> <td>6</td> <td>5</td> <td>4</td> <td>3</td> <td>2</td> <td>1</td> <td>0</td> </tr> <tr> <td>Access</td> <td>r</td> <td>r</td> <td>r</td> <td>r</td> <td>r</td> <td>r</td> <td>r</td> <td>r</td> </tr> <tr> <td>Flag</td> <td>VOUT_OV</td> <td>VOUT_OV_Warn</td> <td>VOUT_UV_Warn</td> <td>VOUT_UV</td> <td>X</td> <td>X</td> <td>X</td> <td>X</td> </tr> <tr> <td>Default Value</td> <td colspan="8">Variable</td> </tr> </table>	Format	Unsigned Binary								Bit Position	7	6	5	4	3	2	1	0	Access	r	r	r	r	r	r	r	r	Flag	VOUT_OV	VOUT_OV_Warn	VOUT_UV_Warn	VOUT_UV	X	X	X	X	Default Value	Variable																																												
Format	Unsigned Binary																																																																																			
Bit Position	7	6	5	4	3	2	1	0																																																																												
Access	r	r	r	r	r	r	r	r																																																																												
Flag	VOUT_OV	VOUT_OV_Warn	VOUT_UV_Warn	VOUT_UV	X	X	X	X																																																																												
Default Value	Variable																																																																																			
7B	STATUS_IOUT	<p>Returns one byte of information with the status of the module's output current related faults</p> <table border="1"> <tr> <td>Format</td> <td colspan="8">Unsigned Binary</td> </tr> <tr> <td>Bit Position</td> <td>7</td> <td>6</td> <td>5</td> <td>4</td> <td>3</td> <td>2</td> <td>1</td> <td>0</td> </tr> <tr> <td>Access</td> <td>r</td> <td>r</td> <td>r</td> <td>r</td> <td>r</td> <td>r</td> <td>r</td> <td>r</td> </tr> <tr> <td>Flag</td> <td>IOUT_OC</td> <td>X</td> <td>X</td> <td>X</td> <td>IOUT_OC_WARN</td> <td>X</td> <td>X</td> <td>X</td> </tr> <tr> <td>Default Value</td> <td colspan="8">Variable</td> </tr> </table>	Format	Unsigned Binary								Bit Position	7	6	5	4	3	2	1	0	Access	r	r	r	r	r	r	r	r	Flag	IOUT_OC	X	X	X	IOUT_OC_WARN	X	X	X	Default Value	Variable																																												
Format	Unsigned Binary																																																																																			
Bit Position	7	6	5	4	3	2	1	0																																																																												
Access	r	r	r	r	r	r	r	r																																																																												
Flag	IOUT_OC	X	X	X	IOUT_OC_WARN	X	X	X																																																																												
Default Value	Variable																																																																																			
7C	STATUS_INPUT	<p>Returns one byte of information with the status of the module's input related faults</p> <table border="1"> <tr> <td>Format</td> <td colspan="8">Unsigned Binary</td> </tr> <tr> <td>Bit Position</td> <td>7</td> <td>6</td> <td>5</td> <td>4</td> <td>3</td> <td>2</td> <td>1</td> <td>0</td> </tr> <tr> <td>Access</td> <td>r</td> <td>r</td> <td>r</td> <td>r</td> <td>r</td> <td>r</td> <td>r</td> <td>r</td> </tr> <tr> <td>Flag</td> <td>VIN_OV_FAULT</td> <td>VIN_OV_W ARNING</td> <td>VIN_UV_W ARNING</td> <td>VIN_UV_FAULT</td> <td>X</td> <td>X</td> <td>X</td> <td>X</td> </tr> <tr> <td>Default Value</td> <td colspan="8">Variable</td> </tr> </table>	Format	Unsigned Binary								Bit Position	7	6	5	4	3	2	1	0	Access	r	r	r	r	r	r	r	r	Flag	VIN_OV_FAULT	VIN_OV_W ARNING	VIN_UV_W ARNING	VIN_UV_FAULT	X	X	X	X	Default Value	Variable																																												
Format	Unsigned Binary																																																																																			
Bit Position	7	6	5	4	3	2	1	0																																																																												
Access	r	r	r	r	r	r	r	r																																																																												
Flag	VIN_OV_FAULT	VIN_OV_W ARNING	VIN_UV_W ARNING	VIN_UV_FAULT	X	X	X	X																																																																												
Default Value	Variable																																																																																			
7D	STATUS_TEMPERATURE	<p>Returns one byte of information with the status of the module's temperature related faults</p> <table border="1"> <tr> <td>Format</td> <td colspan="8">Unsigned Binary</td> </tr> <tr> <td>Bit Position</td> <td>7</td> <td>6</td> <td>5</td> <td>4</td> <td>3</td> <td>2</td> <td>1</td> <td>0</td> </tr> <tr> <td>Access</td> <td>r</td> <td>r</td> <td>r</td> <td>r</td> <td>r</td> <td>r</td> <td>r</td> <td>r</td> </tr> <tr> <td>Flag</td> <td>OT_FAULT</td> <td>OT_WARN</td> <td>X</td> <td>X</td> <td>X</td> <td>X</td> <td>X</td> <td>X</td> </tr> <tr> <td>Default Value</td> <td colspan="8">Variable</td> </tr> </table>	Format	Unsigned Binary								Bit Position	7	6	5	4	3	2	1	0	Access	r	r	r	r	r	r	r	r	Flag	OT_FAULT	OT_WARN	X	X	X	X	X	X	Default Value	Variable																																												
Format	Unsigned Binary																																																																																			
Bit Position	7	6	5	4	3	2	1	0																																																																												
Access	r	r	r	r	r	r	r	r																																																																												
Flag	OT_FAULT	OT_WARN	X	X	X	X	X	X																																																																												
Default Value	Variable																																																																																			
7E	STATUS_CML	<p>Returns one byte of information with the status of the module's communication related faults</p> <table border="1"> <tr> <td>Format</td> <td colspan="8">Unsigned Binary</td> </tr> <tr> <td>Bit Position</td> <td>7</td> <td>6</td> <td>5</td> <td>4</td> <td>3</td> <td>2</td> <td>1</td> <td>0</td> </tr> <tr> <td>Access</td> <td>r</td> <td>r</td> <td>r</td> <td>r</td> <td>r</td> <td>r</td> <td>r</td> <td>r</td> </tr> <tr> <td>Flag</td> <td>Invalid Command</td> <td>Invalid Data</td> <td>PEC Fail</td> <td>X</td> <td>X</td> <td>X</td> <td>Other Comm Fault</td> <td>X</td> </tr> <tr> <td>Default Value</td> <td colspan="8">Variable</td> </tr> </table>	Format	Unsigned Binary								Bit Position	7	6	5	4	3	2	1	0	Access	r	r	r	r	r	r	r	r	Flag	Invalid Command	Invalid Data	PEC Fail	X	X	X	Other Comm Fault	X	Default Value	Variable																																												
Format	Unsigned Binary																																																																																			
Bit Position	7	6	5	4	3	2	1	0																																																																												
Access	r	r	r	r	r	r	r	r																																																																												
Flag	Invalid Command	Invalid Data	PEC Fail	X	X	X	Other Comm Fault	X																																																																												
Default Value	Variable																																																																																			

170A TeraDLynx™: Non-Isolated DC-DC Power Modules

7Vdc -14Vdc input; 0.6Vdc to 1.5Vdc output; 170A Output Current

Table 4 (Continued)

Hex Code	Command	Brief Description	Non-Volatile Memory Storage																																																																																	
88	READ_VIN	<p>Returns the value of the input voltage applied to the module.</p> <table border="1"> <tr> <td>Format</td> <td colspan="8">Linear, two's complement binary</td> </tr> <tr> <td>Bit Position</td> <td>15</td> <td>14</td> <td>13</td> <td>12</td> <td>11</td> <td>10</td> <td>9</td> <td>8</td> </tr> <tr> <td>Access</td> <td>r</td> <td>r</td> <td>r</td> <td>r</td> <td>r</td> <td>r</td> <td>r</td> <td>r</td> </tr> <tr> <td>Function</td> <td colspan="4">Exponent</td> <td colspan="4">Mantissa</td> </tr> <tr> <td>Default Value</td> <td colspan="8">Variable</td> </tr> <tr> <td>Bit Position</td> <td>7</td> <td>6</td> <td>5</td> <td>4</td> <td>3</td> <td>2</td> <td>1</td> <td>0</td> </tr> <tr> <td>Access</td> <td>r</td> <td>r</td> <td>r</td> <td>r</td> <td>r</td> <td>r</td> <td>r</td> <td>r</td> </tr> <tr> <td>Function</td> <td colspan="8">Mantissa</td> </tr> <tr> <td>Default Value</td> <td colspan="8">Variable</td> </tr> </table>	Format	Linear, two's complement binary								Bit Position	15	14	13	12	11	10	9	8	Access	r	r	r	r	r	r	r	r	Function	Exponent				Mantissa				Default Value	Variable								Bit Position	7	6	5	4	3	2	1	0	Access	r	r	r	r	r	r	r	r	Function	Mantissa								Default Value	Variable								
Format	Linear, two's complement binary																																																																																			
Bit Position	15	14	13	12	11	10	9	8																																																																												
Access	r	r	r	r	r	r	r	r																																																																												
Function	Exponent				Mantissa																																																																															
Default Value	Variable																																																																																			
Bit Position	7	6	5	4	3	2	1	0																																																																												
Access	r	r	r	r	r	r	r	r																																																																												
Function	Mantissa																																																																																			
Default Value	Variable																																																																																			
8B	READ_VOUT	<p>Returns the value of the output voltage of the module. Exponent is fixed at -14</p> <table border="1"> <tr> <td>Format</td> <td colspan="8">Linear, two's complement binary</td> </tr> <tr> <td>Bit Position</td> <td>15</td> <td>14</td> <td>13</td> <td>12</td> <td>11</td> <td>10</td> <td>9</td> <td>8</td> </tr> <tr> <td>Access</td> <td>r</td> <td>r</td> <td>r</td> <td>r</td> <td>r</td> <td>r</td> <td>r</td> <td>r</td> </tr> <tr> <td>Function</td> <td colspan="8">Mantissa</td> </tr> <tr> <td>Default Value</td> <td colspan="8">Variable</td> </tr> <tr> <td>Bit Position</td> <td>7</td> <td>6</td> <td>5</td> <td>4</td> <td>3</td> <td>2</td> <td>1</td> <td>0</td> </tr> <tr> <td>Access</td> <td>r</td> <td>r</td> <td>r</td> <td>r</td> <td>r</td> <td>r</td> <td>r</td> <td>r</td> </tr> <tr> <td>Function</td> <td colspan="8">Mantissa</td> </tr> <tr> <td>Default Value</td> <td colspan="8">Variable</td> </tr> </table>	Format	Linear, two's complement binary								Bit Position	15	14	13	12	11	10	9	8	Access	r	r	r	r	r	r	r	r	Function	Mantissa								Default Value	Variable								Bit Position	7	6	5	4	3	2	1	0	Access	r	r	r	r	r	r	r	r	Function	Mantissa								Default Value	Variable								
Format	Linear, two's complement binary																																																																																			
Bit Position	15	14	13	12	11	10	9	8																																																																												
Access	r	r	r	r	r	r	r	r																																																																												
Function	Mantissa																																																																																			
Default Value	Variable																																																																																			
Bit Position	7	6	5	4	3	2	1	0																																																																												
Access	r	r	r	r	r	r	r	r																																																																												
Function	Mantissa																																																																																			
Default Value	Variable																																																																																			
8C	READ_IOUT	<p>Returns the value of the output current of the module.</p> <table border="1"> <tr> <td>Format</td> <td colspan="8">Linear, two's complement binary</td> </tr> <tr> <td>Bit Position</td> <td>15</td> <td>14</td> <td>13</td> <td>12</td> <td>11</td> <td>10</td> <td>9</td> <td>8</td> </tr> <tr> <td>Access</td> <td>r</td> <td>r</td> <td>r</td> <td>r</td> <td>r</td> <td>r</td> <td>r</td> <td>r</td> </tr> <tr> <td>Function</td> <td colspan="4">Exponent</td> <td colspan="4">Mantissa</td> </tr> <tr> <td>Default Value</td> <td colspan="8">Variable</td> </tr> <tr> <td>Bit Position</td> <td>7</td> <td>6</td> <td>5</td> <td>4</td> <td>3</td> <td>2</td> <td>1</td> <td>0</td> </tr> <tr> <td>Access</td> <td>r</td> <td>r</td> <td>r</td> <td>r</td> <td>r</td> <td>r</td> <td>r</td> <td>r</td> </tr> <tr> <td>Function</td> <td colspan="8">Mantissa</td> </tr> <tr> <td>Default Value</td> <td colspan="8">Variable</td> </tr> </table>	Format	Linear, two's complement binary								Bit Position	15	14	13	12	11	10	9	8	Access	r	r	r	r	r	r	r	r	Function	Exponent				Mantissa				Default Value	Variable								Bit Position	7	6	5	4	3	2	1	0	Access	r	r	r	r	r	r	r	r	Function	Mantissa								Default Value	Variable								
Format	Linear, two's complement binary																																																																																			
Bit Position	15	14	13	12	11	10	9	8																																																																												
Access	r	r	r	r	r	r	r	r																																																																												
Function	Exponent				Mantissa																																																																															
Default Value	Variable																																																																																			
Bit Position	7	6	5	4	3	2	1	0																																																																												
Access	r	r	r	r	r	r	r	r																																																																												
Function	Mantissa																																																																																			
Default Value	Variable																																																																																			
8D	READ_TEMPERATURE_1	<p>Returns a module FET package temperature in °C.</p> <table border="1"> <tr> <td>Format</td> <td colspan="8">Linear, two's complement binary</td> </tr> <tr> <td>Bit Position</td> <td>15</td> <td>14</td> <td>13</td> <td>12</td> <td>11</td> <td>10</td> <td>9</td> <td>8</td> </tr> <tr> <td>Access</td> <td>r</td> <td>r</td> <td>r</td> <td>r</td> <td>r</td> <td>r</td> <td>r</td> <td>r</td> </tr> <tr> <td>Function</td> <td colspan="4">Exponent</td> <td colspan="4">Mantissa</td> </tr> <tr> <td>Default Value</td> <td colspan="8">Variable</td> </tr> <tr> <td>Bit Position</td> <td>7</td> <td>6</td> <td>5</td> <td>4</td> <td>3</td> <td>2</td> <td>1</td> <td>0</td> </tr> <tr> <td>Access</td> <td>r</td> <td>r</td> <td>r</td> <td>r</td> <td>r</td> <td>r</td> <td>r</td> <td>r</td> </tr> <tr> <td>Function</td> <td colspan="8">Mantissa</td> </tr> <tr> <td>Default Value</td> <td colspan="8">Variable</td> </tr> </table>	Format	Linear, two's complement binary								Bit Position	15	14	13	12	11	10	9	8	Access	r	r	r	r	r	r	r	r	Function	Exponent				Mantissa				Default Value	Variable								Bit Position	7	6	5	4	3	2	1	0	Access	r	r	r	r	r	r	r	r	Function	Mantissa								Default Value	Variable								
Format	Linear, two's complement binary																																																																																			
Bit Position	15	14	13	12	11	10	9	8																																																																												
Access	r	r	r	r	r	r	r	r																																																																												
Function	Exponent				Mantissa																																																																															
Default Value	Variable																																																																																			
Bit Position	7	6	5	4	3	2	1	0																																																																												
Access	r	r	r	r	r	r	r	r																																																																												
Function	Mantissa																																																																																			
Default Value	Variable																																																																																			
8E	READ_TEMPERATURE_2	<p>Returns the module PWM controller temperature in °C.</p> <table border="1"> <tr> <td>Format</td> <td colspan="8">Linear, two's complement binary</td> </tr> <tr> <td>Bit Position</td> <td>15</td> <td>14</td> <td>13</td> <td>12</td> <td>11</td> <td>10</td> <td>9</td> <td>8</td> </tr> <tr> <td>Access</td> <td>r</td> <td>r</td> <td>r</td> <td>r</td> <td>r</td> <td>r</td> <td>r</td> <td>r</td> </tr> <tr> <td>Function</td> <td colspan="4">Exponent</td> <td colspan="4">Mantissa</td> </tr> <tr> <td>Default Value</td> <td colspan="8">Variable</td> </tr> <tr> <td>Bit Position</td> <td>7</td> <td>6</td> <td>5</td> <td>4</td> <td>3</td> <td>2</td> <td>1</td> <td>0</td> </tr> <tr> <td>Access</td> <td>r</td> <td>r</td> <td>r</td> <td>r</td> <td>r</td> <td>r</td> <td>r</td> <td>r</td> </tr> <tr> <td>Function</td> <td colspan="8">Mantissa</td> </tr> <tr> <td>Default Value</td> <td colspan="8">Variable</td> </tr> </table>	Format	Linear, two's complement binary								Bit Position	15	14	13	12	11	10	9	8	Access	r	r	r	r	r	r	r	r	Function	Exponent				Mantissa				Default Value	Variable								Bit Position	7	6	5	4	3	2	1	0	Access	r	r	r	r	r	r	r	r	Function	Mantissa								Default Value	Variable								
Format	Linear, two's complement binary																																																																																			
Bit Position	15	14	13	12	11	10	9	8																																																																												
Access	r	r	r	r	r	r	r	r																																																																												
Function	Exponent				Mantissa																																																																															
Default Value	Variable																																																																																			
Bit Position	7	6	5	4	3	2	1	0																																																																												
Access	r	r	r	r	r	r	r	r																																																																												
Function	Mantissa																																																																																			
Default Value	Variable																																																																																			

170A TeraDLynx™: Non-Isolated DC-DC Power Modules

7Vdc -14Vdc input; 0.6Vdc to 1.5Vdc output; 170A Output Current

Table 4 (Continued)

Hex Code	Command	Brief Description	Non-Volatile Memory Storage																																																																																	
95	READ_FREQUENCY	<p>Returns the switching Frequency of the converter. The Frequency is in Kilohertz and is read only, consisting of two bytes.</p> <table border="1"> <tr> <td>Format</td> <td colspan="8">Linear, two's complement binary</td> </tr> <tr> <td>Bit Position</td> <td>15</td><td>14</td><td>13</td><td>12</td><td>11</td><td>10</td><td>9</td><td>8</td> </tr> <tr> <td>Access</td> <td>r</td><td>r</td><td>r</td><td>r</td><td>r</td><td>r</td><td>r</td><td>r</td> </tr> <tr> <td>Function</td> <td colspan="8">Integer</td> </tr> <tr> <td>Default Value</td> <td>0</td><td>0</td><td>0</td><td>0</td><td>0</td><td>0</td><td>0</td><td>1</td> </tr> <tr> <td>Bit Position</td> <td>7</td><td>6</td><td>5</td><td>4</td><td>3</td><td>2</td><td>1</td><td>0</td> </tr> <tr> <td>Access</td> <td>r</td><td>r</td><td>r</td><td>r</td><td>r</td><td>r</td><td>r</td><td>r</td> </tr> <tr> <td>Function</td> <td colspan="8">Integer</td> </tr> <tr> <td>Default Value</td> <td>1</td><td>0</td><td>0</td><td>1</td><td>0</td><td>0</td><td>0</td><td>0</td> </tr> </table>	Format	Linear, two's complement binary								Bit Position	15	14	13	12	11	10	9	8	Access	r	r	r	r	r	r	r	r	Function	Integer								Default Value	0	0	0	0	0	0	0	1	Bit Position	7	6	5	4	3	2	1	0	Access	r	r	r	r	r	r	r	r	Function	Integer								Default Value	1	0	0	1	0	0	0	0	
Format	Linear, two's complement binary																																																																																			
Bit Position	15	14	13	12	11	10	9	8																																																																												
Access	r	r	r	r	r	r	r	r																																																																												
Function	Integer																																																																																			
Default Value	0	0	0	0	0	0	0	1																																																																												
Bit Position	7	6	5	4	3	2	1	0																																																																												
Access	r	r	r	r	r	r	r	r																																																																												
Function	Integer																																																																																			
Default Value	1	0	0	1	0	0	0	0																																																																												
98	PMBUS_REVISION	<p>Returns one byte indicating the module is compliant to PMBus Spec. 1.1</p> <table border="1"> <tr> <td>Format</td> <td colspan="8">Unsigned Binary</td> </tr> <tr> <td>Bit Position</td> <td>7</td><td>6</td><td>5</td><td>4</td><td>3</td><td>2</td><td>1</td><td>0</td> </tr> <tr> <td>Access</td> <td>r</td><td>r</td><td>r</td><td>r</td><td>r</td><td>r</td><td>r</td><td>r</td> </tr> <tr> <td>Default Value</td> <td>0</td><td>0</td><td>0</td><td>1</td><td>0</td><td>0</td><td>0</td><td>1</td> </tr> </table>	Format	Unsigned Binary								Bit Position	7	6	5	4	3	2	1	0	Access	r	r	r	r	r	r	r	r	Default Value	0	0	0	1	0	0	0	1	YES																																													
Format	Unsigned Binary																																																																																			
Bit Position	7	6	5	4	3	2	1	0																																																																												
Access	r	r	r	r	r	r	r	r																																																																												
Default Value	0	0	0	1	0	0	0	1																																																																												
B0	MFR_SPECIFIC_KP	<p>Value used to program specific proportional coefficient of the PID compensation Block. Do not use value higher than 10922</p> <table border="1"> <tr> <td>Format</td> <td colspan="8">Linear, two's complement binary</td> </tr> <tr> <td>Bit Position</td> <td>15</td><td>14</td><td>13</td><td>12</td><td>11</td><td>10</td><td>9</td><td>8</td> </tr> <tr> <td>Access</td> <td>r/w</td><td>r/w</td><td>r/w</td><td>r/w</td><td>r/w</td><td>r/w</td><td>r/w</td><td>r/w</td> </tr> <tr> <td>Function</td> <td colspan="8">Integer</td> </tr> <tr> <td>Default Value</td> <td colspan="8">Variable</td> </tr> <tr> <td>Bit Position</td> <td>7</td><td>6</td><td>5</td><td>4</td><td>3</td><td>2</td><td>1</td><td>0</td> </tr> <tr> <td>Access</td> <td>r/w</td><td>r/w</td><td>r/w</td><td>r/w</td><td>r/w</td><td>r/w</td><td>r/w</td><td>r/w</td> </tr> <tr> <td>Function</td> <td colspan="8">Integer</td> </tr> <tr> <td>Default Value</td> <td colspan="8">Variable</td> </tr> </table>	Format	Linear, two's complement binary								Bit Position	15	14	13	12	11	10	9	8	Access	r/w	r/w	r/w	r/w	r/w	r/w	r/w	r/w	Function	Integer								Default Value	Variable								Bit Position	7	6	5	4	3	2	1	0	Access	r/w	r/w	r/w	r/w	r/w	r/w	r/w	r/w	Function	Integer								Default Value	Variable								YES
Format	Linear, two's complement binary																																																																																			
Bit Position	15	14	13	12	11	10	9	8																																																																												
Access	r/w	r/w	r/w	r/w	r/w	r/w	r/w	r/w																																																																												
Function	Integer																																																																																			
Default Value	Variable																																																																																			
Bit Position	7	6	5	4	3	2	1	0																																																																												
Access	r/w	r/w	r/w	r/w	r/w	r/w	r/w	r/w																																																																												
Function	Integer																																																																																			
Default Value	Variable																																																																																			
B1	MFR_SPECIFIC_KI	<p>Value used to program specific integral coefficient of the PID compensation Block Do not use value higher than 10922</p> <table border="1"> <tr> <td>Format</td> <td colspan="8">Linear, two's complement binary</td> </tr> <tr> <td>Bit Position</td> <td>15</td><td>14</td><td>13</td><td>12</td><td>11</td><td>10</td><td>9</td><td>8</td> </tr> <tr> <td>Access</td> <td>r/w</td><td>r/w</td><td>r/w</td><td>r/w</td><td>r/w</td><td>r/w</td><td>r/w</td><td>r/w</td> </tr> <tr> <td>Function</td> <td colspan="8">Integer</td> </tr> <tr> <td>Default Value</td> <td colspan="8">Variable</td> </tr> <tr> <td>Bit Position</td> <td>7</td><td>6</td><td>5</td><td>4</td><td>3</td><td>2</td><td>1</td><td>0</td> </tr> <tr> <td>Access</td> <td>r/w</td><td>r/w</td><td>r/w</td><td>r/w</td><td>r/w</td><td>r/w</td><td>r/w</td><td>r/w</td> </tr> <tr> <td>Function</td> <td colspan="8">Integer</td> </tr> <tr> <td>Default Value</td> <td colspan="8">Variable</td> </tr> </table>	Format	Linear, two's complement binary								Bit Position	15	14	13	12	11	10	9	8	Access	r/w	r/w	r/w	r/w	r/w	r/w	r/w	r/w	Function	Integer								Default Value	Variable								Bit Position	7	6	5	4	3	2	1	0	Access	r/w	r/w	r/w	r/w	r/w	r/w	r/w	r/w	Function	Integer								Default Value	Variable								YES
Format	Linear, two's complement binary																																																																																			
Bit Position	15	14	13	12	11	10	9	8																																																																												
Access	r/w	r/w	r/w	r/w	r/w	r/w	r/w	r/w																																																																												
Function	Integer																																																																																			
Default Value	Variable																																																																																			
Bit Position	7	6	5	4	3	2	1	0																																																																												
Access	r/w	r/w	r/w	r/w	r/w	r/w	r/w	r/w																																																																												
Function	Integer																																																																																			
Default Value	Variable																																																																																			
B2	MFR_SPECIFIC_KD	<p>Value used to program specific differential coefficient of the PID compensation. Do not use value higher than 10922</p> <table border="1"> <tr> <td>Format</td> <td colspan="8">Linear, two's complement binary</td> </tr> <tr> <td>Bit Position</td> <td>15</td><td>14</td><td>13</td><td>12</td><td>11</td><td>10</td><td>9</td><td>8</td> </tr> <tr> <td>Access</td> <td>r/w</td><td>r/w</td><td>r/w</td><td>r/w</td><td>r/w</td><td>r/w</td><td>r/w</td><td>r/w</td> </tr> <tr> <td>Function</td> <td colspan="8">Integer</td> </tr> <tr> <td>Default Value</td> <td colspan="8">Variable</td> </tr> <tr> <td>Bit Position</td> <td>7</td><td>6</td><td>5</td><td>4</td><td>3</td><td>2</td><td>1</td><td>0</td> </tr> <tr> <td>Access</td> <td>r/w</td><td>r/w</td><td>r/w</td><td>r/w</td><td>r/w</td><td>r/w</td><td>r/w</td><td>r/w</td> </tr> <tr> <td>Function</td> <td colspan="8">Integer</td> </tr> <tr> <td>Default Value</td> <td colspan="8">Variable</td> </tr> </table>	Format	Linear, two's complement binary								Bit Position	15	14	13	12	11	10	9	8	Access	r/w	r/w	r/w	r/w	r/w	r/w	r/w	r/w	Function	Integer								Default Value	Variable								Bit Position	7	6	5	4	3	2	1	0	Access	r/w	r/w	r/w	r/w	r/w	r/w	r/w	r/w	Function	Integer								Default Value	Variable								YES
Format	Linear, two's complement binary																																																																																			
Bit Position	15	14	13	12	11	10	9	8																																																																												
Access	r/w	r/w	r/w	r/w	r/w	r/w	r/w	r/w																																																																												
Function	Integer																																																																																			
Default Value	Variable																																																																																			
Bit Position	7	6	5	4	3	2	1	0																																																																												
Access	r/w	r/w	r/w	r/w	r/w	r/w	r/w	r/w																																																																												
Function	Integer																																																																																			
Default Value	Variable																																																																																			
B3	MFR_SPECIFIC_ALPHA	<p>Value used to program specific alpha value of the PID compensation block</p> <table border="1"> <tr> <td>Format</td> <td colspan="8">Linear, two's complement binary</td> </tr> <tr> <td>Bit Position</td> <td>15</td><td>14</td><td>13</td><td>12</td><td>11</td><td>10</td><td>9</td><td>8</td> </tr> <tr> <td>Access</td> <td>r/w</td><td>r/w</td><td>r/w</td><td>r/w</td><td>r/w</td><td>r/w</td><td>r/w</td><td>r/w</td> </tr> <tr> <td>Function</td> <td colspan="8">Integer</td> </tr> <tr> <td>Default Value</td> <td colspan="8">Variable</td> </tr> <tr> <td>Bit Position</td> <td>7</td><td>6</td><td>5</td><td>4</td><td>3</td><td>2</td><td>1</td><td>0</td> </tr> <tr> <td>Access</td> <td>r/w</td><td>r/w</td><td>r/w</td><td>r/w</td><td>r/w</td><td>r/w</td><td>r/w</td><td>r/w</td> </tr> <tr> <td>Function</td> <td colspan="8">Integer</td> </tr> <tr> <td>Default Value</td> <td colspan="8">Variable</td> </tr> </table>	Format	Linear, two's complement binary								Bit Position	15	14	13	12	11	10	9	8	Access	r/w	r/w	r/w	r/w	r/w	r/w	r/w	r/w	Function	Integer								Default Value	Variable								Bit Position	7	6	5	4	3	2	1	0	Access	r/w	r/w	r/w	r/w	r/w	r/w	r/w	r/w	Function	Integer								Default Value	Variable								YES
Format	Linear, two's complement binary																																																																																			
Bit Position	15	14	13	12	11	10	9	8																																																																												
Access	r/w	r/w	r/w	r/w	r/w	r/w	r/w	r/w																																																																												
Function	Integer																																																																																			
Default Value	Variable																																																																																			
Bit Position	7	6	5	4	3	2	1	0																																																																												
Access	r/w	r/w	r/w	r/w	r/w	r/w	r/w	r/w																																																																												
Function	Integer																																																																																			
Default Value	Variable																																																																																			

170A TeraDlynx™: Non-Isolated DC-DC Power Modules

7Vdc –14Vdc input; 0.6Vdc to 1.5Vdc output; 170A Output Current

Table 4 (Continued)

Hex Code	Command	Brief Description	Non-Volatile Memory Storage																																																																																	
D0	MFR_SPECIFIC_00	<p>Returns module name information (read only)</p> <table border="1"> <tr> <td>Format</td> <td colspan="8">Unsigned Binary</td> </tr> <tr> <td>Bit Position</td> <td>15</td> <td>14</td> <td>13</td> <td>12</td> <td>11</td> <td>10</td> <td>9</td> <td>8</td> </tr> <tr> <td>Access</td> <td>r</td> <td>r</td> <td>r</td> <td>r</td> <td>r</td> <td>r</td> <td>r</td> <td>r</td> </tr> <tr> <td>Function</td> <td colspan="8">Reserved</td> </tr> <tr> <td>Default Value</td> <td>0</td> <td>0</td> <td>0</td> <td>0</td> <td>0</td> <td>0</td> <td>0</td> <td>0</td> </tr> <tr> <td>Bit Position</td> <td>7</td> <td>6</td> <td>5</td> <td>4</td> <td>3</td> <td>2</td> <td>1</td> <td>0</td> </tr> <tr> <td>Access</td> <td>r</td> <td>r</td> <td>r</td> <td>r</td> <td>r</td> <td>r</td> <td>r</td> <td>r</td> </tr> <tr> <td>Function</td> <td colspan="6">Module Name</td> <td colspan="2">Reserved</td> </tr> <tr> <td>Default Value</td> <td>0</td> <td>0</td> <td>1</td> <td>1</td> <td>1</td> <td>0</td> <td>0</td> <td>0</td> </tr> </table>	Format	Unsigned Binary								Bit Position	15	14	13	12	11	10	9	8	Access	r	r	r	r	r	r	r	r	Function	Reserved								Default Value	0	0	0	0	0	0	0	0	Bit Position	7	6	5	4	3	2	1	0	Access	r	r	r	r	r	r	r	r	Function	Module Name						Reserved		Default Value	0	0	1	1	1	0	0	0	YES
Format	Unsigned Binary																																																																																			
Bit Position	15	14	13	12	11	10	9	8																																																																												
Access	r	r	r	r	r	r	r	r																																																																												
Function	Reserved																																																																																			
Default Value	0	0	0	0	0	0	0	0																																																																												
Bit Position	7	6	5	4	3	2	1	0																																																																												
Access	r	r	r	r	r	r	r	r																																																																												
Function	Module Name						Reserved																																																																													
Default Value	0	0	1	1	1	0	0	0																																																																												
D4	MFR_READ_VOUT_CAL_OF FSET	<p>Applies an offset to the READ_VOUT command results to calibrate out offset errors in module measurements of the output voltage (between -125mV and +124mV). Exponent is fixed at -14.</p> <table border="1"> <tr> <td>Format</td> <td colspan="8">Linear, two's complement binary</td> </tr> <tr> <td>Bit Position</td> <td>15</td> <td>14</td> <td>13</td> <td>12</td> <td>11</td> <td>10</td> <td>9</td> <td>8</td> </tr> <tr> <td>Access</td> <td>r/w</td> <td>r/w</td> <td>r/w</td> <td>r/w</td> <td>r/w</td> <td>r/w</td> <td>r/w</td> <td>r/w</td> </tr> <tr> <td>Function</td> <td colspan="8">Mantissa</td> </tr> <tr> <td>Default Value</td> <td colspan="8">Variable based on factory calibration</td> </tr> <tr> <td>Bit Position</td> <td>7</td> <td>6</td> <td>5</td> <td>4</td> <td>3</td> <td>2</td> <td>1</td> <td>0</td> </tr> <tr> <td>Access</td> <td>r/w</td> <td>r/w</td> <td>r/w</td> <td>r/w</td> <td>r/w</td> <td>r/w</td> <td>r/w</td> <td>r/w</td> </tr> <tr> <td>Function</td> <td colspan="8">Mantissa</td> </tr> <tr> <td>Default Value</td> <td colspan="8">Variable based on factory calibration</td> </tr> </table>	Format	Linear, two's complement binary								Bit Position	15	14	13	12	11	10	9	8	Access	r/w	r/w	r/w	r/w	r/w	r/w	r/w	r/w	Function	Mantissa								Default Value	Variable based on factory calibration								Bit Position	7	6	5	4	3	2	1	0	Access	r/w	r/w	r/w	r/w	r/w	r/w	r/w	r/w	Function	Mantissa								Default Value	Variable based on factory calibration								YES
Format	Linear, two's complement binary																																																																																			
Bit Position	15	14	13	12	11	10	9	8																																																																												
Access	r/w	r/w	r/w	r/w	r/w	r/w	r/w	r/w																																																																												
Function	Mantissa																																																																																			
Default Value	Variable based on factory calibration																																																																																			
Bit Position	7	6	5	4	3	2	1	0																																																																												
Access	r/w	r/w	r/w	r/w	r/w	r/w	r/w	r/w																																																																												
Function	Mantissa																																																																																			
Default Value	Variable based on factory calibration																																																																																			
D7	MFR_VOUT_CAL_OFFSET	<p>Applies an offset to the commanded output voltage to calibrate out errors in setting module output voltage (between -63mV and +62mV) when using Trim resistor. Exponent is fixed at -14.</p> <table border="1"> <tr> <td>Format</td> <td colspan="8">Linear, two's complement binary</td> </tr> <tr> <td>Bit Position</td> <td>15</td> <td>14</td> <td>13</td> <td>12</td> <td>11</td> <td>10</td> <td>9</td> <td>8</td> </tr> <tr> <td>Access</td> <td>r/w</td> <td>r/w</td> <td>r/w</td> <td>r/w</td> <td>r/w</td> <td>r/w</td> <td>r/w</td> <td>r/w</td> </tr> <tr> <td>Function</td> <td colspan="8">Mantissa</td> </tr> <tr> <td>Default Value</td> <td colspan="8">Variable based on factory calibration</td> </tr> <tr> <td>Bit Position</td> <td>7</td> <td>6</td> <td>5</td> <td>4</td> <td>3</td> <td>2</td> <td>1</td> <td>0</td> </tr> <tr> <td>Access</td> <td>r/w</td> <td>r/w</td> <td>r/w</td> <td>r/w</td> <td>r/w</td> <td>r/w</td> <td>r/w</td> <td>r/w</td> </tr> <tr> <td>Function</td> <td colspan="8">Mantissa</td> </tr> <tr> <td>Default Value</td> <td colspan="8">Variable based on factory calibration</td> </tr> </table>	Format	Linear, two's complement binary								Bit Position	15	14	13	12	11	10	9	8	Access	r/w	r/w	r/w	r/w	r/w	r/w	r/w	r/w	Function	Mantissa								Default Value	Variable based on factory calibration								Bit Position	7	6	5	4	3	2	1	0	Access	r/w	r/w	r/w	r/w	r/w	r/w	r/w	r/w	Function	Mantissa								Default Value	Variable based on factory calibration								YES
Format	Linear, two's complement binary																																																																																			
Bit Position	15	14	13	12	11	10	9	8																																																																												
Access	r/w	r/w	r/w	r/w	r/w	r/w	r/w	r/w																																																																												
Function	Mantissa																																																																																			
Default Value	Variable based on factory calibration																																																																																			
Bit Position	7	6	5	4	3	2	1	0																																																																												
Access	r/w	r/w	r/w	r/w	r/w	r/w	r/w	r/w																																																																												
Function	Mantissa																																																																																			
Default Value	Variable based on factory calibration																																																																																			
D8	MFR_VOUT_SET_MODE	<p>Bit 7 used to determine whether output voltage is set using RTrim or the VOUT_COMMAND. Bit 7: 1 – Output voltage is solely set by RTrim value and can be adjusted from set value using the VOUT_TRIM command Bit 7: 0 – Output voltage is solely set by VOUT_COMMAND and can be adjusted from set value using the VOUT_TRIM command. Bit 0: Used to indicate whether changes have been made to the Vout set point, PG On/Off levels, margin levels or OV/UV fault/warning levels. A 1 in this position indicates that one or more of the values have changed from the default. If this bit is 0, then the default values are used.</p> <table border="1"> <tr> <td>Format</td> <td colspan="8">Unsigned Binary</td> </tr> <tr> <td>Bit Position</td> <td>7</td> <td>6</td> <td>5</td> <td>4</td> <td>3</td> <td>2</td> <td>1</td> <td>0</td> </tr> <tr> <td>Access</td> <td>r/w</td> <td>r/w</td> <td>r/w</td> <td>r/w</td> <td>r/w</td> <td>r/w</td> <td>r/w</td> <td>r/w</td> </tr> <tr> <td>Flag</td> <td>VOUT_SE T_MODE</td> <td>X</td> <td>X</td> <td>X</td> <td>X</td> <td>X</td> <td>X</td> <td>USER_CHANGES</td> </tr> <tr> <td>Default Value</td> <td>1</td> <td>0</td> <td>0</td> <td>0</td> <td>0</td> <td>0</td> <td>0</td> <td>0</td> </tr> </table>	Format	Unsigned Binary								Bit Position	7	6	5	4	3	2	1	0	Access	r/w	r/w	r/w	r/w	r/w	r/w	r/w	r/w	Flag	VOUT_SE T_MODE	X	X	X	X	X	X	USER_CHANGES	Default Value	1	0	0	0	0	0	0	0	YES																																				
Format	Unsigned Binary																																																																																			
Bit Position	7	6	5	4	3	2	1	0																																																																												
Access	r/w	r/w	r/w	r/w	r/w	r/w	r/w	r/w																																																																												
Flag	VOUT_SE T_MODE	X	X	X	X	X	X	USER_CHANGES																																																																												
Default Value	1	0	0	0	0	0	0	0																																																																												
DB	MFR_FW_REVISION	<p>Value used to program the firmware revision. This command is read only.</p> <table border="1"> <tr> <td>Format</td> <td colspan="8">Linear, two's complement binary</td> </tr> <tr> <td>Bit Position</td> <td>15</td> <td>14</td> <td>13</td> <td>12</td> <td>11</td> <td>10</td> <td>9</td> <td>8</td> </tr> <tr> <td>Access</td> <td>r/w</td> <td>r/w</td> <td>r/w</td> <td>r/w</td> <td>r/w</td> <td>r/w</td> <td>r/w</td> <td>r/w</td> </tr> <tr> <td>Function</td> <td colspan="8">Integer – Major Version</td> </tr> <tr> <td>Default Value</td> <td colspan="8">Variable</td> </tr> <tr> <td>Bit Position</td> <td>7</td> <td>6</td> <td>5</td> <td>4</td> <td>3</td> <td>2</td> <td>1</td> <td>0</td> </tr> <tr> <td>Access</td> <td>r/w</td> <td>r/w</td> <td>r/w</td> <td>r/w</td> <td>r/w</td> <td>r/w</td> <td>r/w</td> <td>r/w</td> </tr> <tr> <td>Function</td> <td colspan="8">Integer – Minor Version</td> </tr> <tr> <td>Default Value</td> <td colspan="8">Variable</td> </tr> </table>	Format	Linear, two's complement binary								Bit Position	15	14	13	12	11	10	9	8	Access	r/w	r/w	r/w	r/w	r/w	r/w	r/w	r/w	Function	Integer – Major Version								Default Value	Variable								Bit Position	7	6	5	4	3	2	1	0	Access	r/w	r/w	r/w	r/w	r/w	r/w	r/w	r/w	Function	Integer – Minor Version								Default Value	Variable								
Format	Linear, two's complement binary																																																																																			
Bit Position	15	14	13	12	11	10	9	8																																																																												
Access	r/w	r/w	r/w	r/w	r/w	r/w	r/w	r/w																																																																												
Function	Integer – Major Version																																																																																			
Default Value	Variable																																																																																			
Bit Position	7	6	5	4	3	2	1	0																																																																												
Access	r/w	r/w	r/w	r/w	r/w	r/w	r/w	r/w																																																																												
Function	Integer – Minor Version																																																																																			
Default Value	Variable																																																																																			

170A TeraDlynx™: Non-Isolated DC-DC Power Modules

7Vdc –14Vdc input; 0.6Vdc to 1.5Vdc output; 170A Output Current

Table 4 (Continued)

Hex Code	Command	Brief Description	Non-Volatile Memory Storage																																																																																										
DD	MFR_RTUNE_INDEX	<p>Returns the index derived from the resistor strapped to the RTUNE pin of the module. Range is from 0 to 59.</p> <table border="1"> <tr> <td>Format</td> <td colspan="9">Unsigned Binary</td> </tr> <tr> <td>Bit Position</td> <td>7</td> <td>6</td> <td>5</td> <td>4</td> <td>3</td> <td>2</td> <td>1</td> <td>0</td> <td></td> </tr> <tr> <td>Access</td> <td>r</td> <td>r</td> <td>r</td> <td>r</td> <td>r</td> <td>r</td> <td>r</td> <td>r</td> <td>r</td> </tr> <tr> <td>Function</td> <td colspan="9">Integer</td> </tr> <tr> <td>Default Value</td> <td colspan="9">Variable</td> </tr> </table>	Format	Unsigned Binary									Bit Position	7	6	5	4	3	2	1	0		Access	r	r	r	r	r	r	r	r	r	Function	Integer									Default Value	Variable									YES																																								
Format	Unsigned Binary																																																																																												
Bit Position	7	6	5	4	3	2	1	0																																																																																					
Access	r	r	r	r	r	r	r	r	r																																																																																				
Function	Integer																																																																																												
Default Value	Variable																																																																																												
DF	MFR_WRITE_PROTECT	<p>Gets or sets the write protection status of various PMBus commands. When a bit is set, the corresponding PMBus command is write protected and can only be read.</p> <table border="1"> <tr> <td>Format</td> <td colspan="9">Unsigned Binary</td> </tr> <tr> <td>Bit Position</td> <td>15</td> <td>14</td> <td>13</td> <td>12</td> <td>11</td> <td>10</td> <td>9</td> <td>8</td> <td></td> </tr> <tr> <td>Access</td> <td>r</td> <td>r</td> <td>r</td> <td>r</td> <td>r</td> <td>r</td> <td>r</td> <td>r</td> <td>r</td> </tr> <tr> <td>Function</td> <td colspan="9">Reserved</td> </tr> <tr> <td>Default Value</td> <td>x</td> <td>x</td> <td>x</td> <td>x</td> <td>x</td> <td>x</td> <td>x</td> <td>x</td> <td>x</td> </tr> <tr> <td>Bit Position</td> <td>7</td> <td>6</td> <td>5</td> <td>4</td> <td>3</td> <td>2</td> <td>1</td> <td>0</td> <td></td> </tr> <tr> <td>Access</td> <td>r</td> <td>r</td> <td>r</td> <td>r</td> <td>r/w</td> <td>r/w</td> <td>r/w</td> <td>r/w</td> <td></td> </tr> <tr> <td>Function</td> <td colspan="5">Reserved</td> <td colspan="4">Used</td> </tr> <tr> <td>Default Value</td> <td>x</td> <td>x</td> <td>x</td> <td>x</td> <td>1</td> <td>1</td> <td>1</td> <td>0</td> <td></td> </tr> </table> <p>Bit 0: ON_OFF_CONFIG Bit 1: IOUT_OC_FAULT_LIMIT Bit 2: OT_FAULT_LIMIT Bit 3: OT_FAULT_RESP Bits 4 – 15: Reserved</p>	Format	Unsigned Binary									Bit Position	15	14	13	12	11	10	9	8		Access	r	r	r	r	r	r	r	r	r	Function	Reserved									Default Value	x	x	x	x	x	x	x	x	x	Bit Position	7	6	5	4	3	2	1	0		Access	r	r	r	r	r/w	r/w	r/w	r/w		Function	Reserved					Used				Default Value	x	x	x	x	1	1	1	0		YES
Format	Unsigned Binary																																																																																												
Bit Position	15	14	13	12	11	10	9	8																																																																																					
Access	r	r	r	r	r	r	r	r	r																																																																																				
Function	Reserved																																																																																												
Default Value	x	x	x	x	x	x	x	x	x																																																																																				
Bit Position	7	6	5	4	3	2	1	0																																																																																					
Access	r	r	r	r	r/w	r/w	r/w	r/w																																																																																					
Function	Reserved					Used																																																																																							
Default Value	x	x	x	x	1	1	1	0																																																																																					
F0	MFR_MODULE_DATE_LOC_SN	<p>Read only command which returns 12 bytes with the value of YYFFWWXXXXXX, where YY : year of manufacture FF: Factory where manufactured WW: Fiscal week of the year when unit was manufactured XXXXXX: Unique number for the specific unit – corresponding to serial number on the label of the unit.</p>	YES																																																																																										

SMBALERT# is also triggered:

- when an invalid/unrecognized PMBus command (write or read) is issued
- By invalid PMBus data (write)
- By PEC Failure (when used)
- By Enable OFF (when used)
- Module is out of Power Good Range

Digital Power Insight (DPI)

GE offers a software tool that set helps users evaluate and simulate the PMBus performance of the TJT170A modules without the need to write software.

The software can be downloaded for free at <http://go.ge-energy.com/DigitalPowerInsight.html>. A GE USB to I2C adapter and associated cable set are required for proper functioning of the software suite. For first time users, the GE DPI Evaluation Kit can be purchased from leading distributors at a nominal price and can be used across the entire range of GE Digital POL Modules.

170A TeraDLynx™: Non-Isolated DC-DC Power Modules

7Vdc –14Vdc input; 0.6Vdc to 1.5Vdc output; 170A Output Current

Thermal Considerations

Power modules operate in a variety of thermal environments; however, sufficient cooling should always be provided to help ensure reliable operation.

Considerations include ambient temperature, airflow, module power dissipation, and the need for increased reliability. A reduction in the operating temperature of the module will result in an increase in reliability. The thermal data presented here is based on physical measurements taken in a wind tunnel. The test set-up is shown in Figure 37. The preferred airflow direction for the module is in Figure 38.

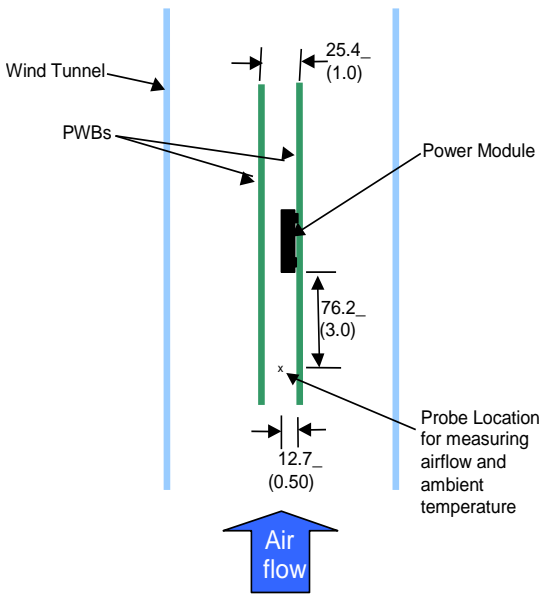

Figure 37. Thermal Test Setup.

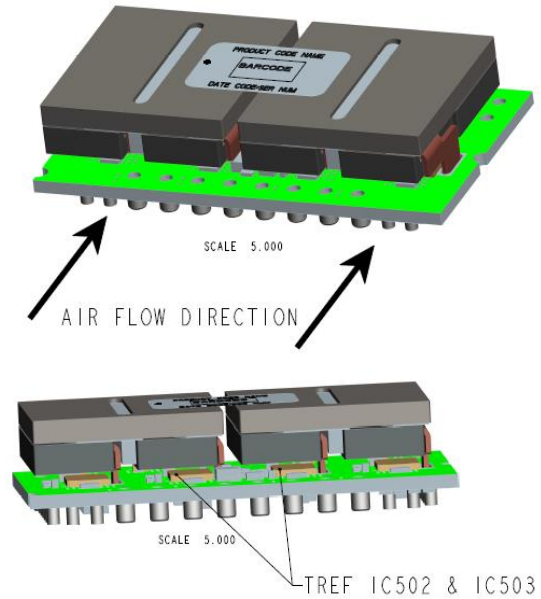

Figure 38. Preferred airflow direction and location of hot-spots of the module (Tref).

The thermal reference points, T_{ref} used in the specifications are also shown in Figure 38. For reliable operation the temperatures at these points should not exceed 120°C. The output power of the module should not exceed the rated power of the module ($V_{o,set} \times I_{o,max}$).

Please refer to the Application Note “Thermal Characterization Process For Open-Frame Board-Mounted Power Modules” for a detailed discussion of thermal aspects including maximum device temperatures.

170A TeraDLynx™: Non-Isolated DC-DC Power Modules

7Vdc -14Vdc input; 0.6Vdc to 1.5Vdc output; 170A Output Current

Example Application Circuit

Requirements:

- Vin: 12V
- Vout: 1.2V
- Iout: 170A max., worst case load transient is from 85A to 127.5A, 10A/usec
- ΔVout: 25mV for worst case load transient
- Vin, ripple: 2% of Vin (240mV p-p)

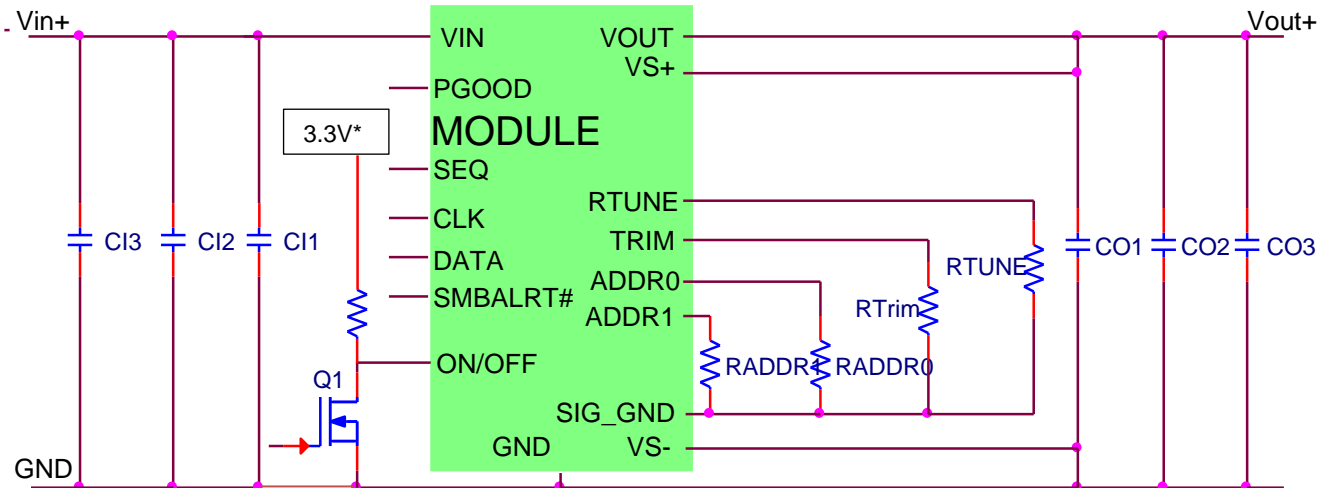

3.3V* can be derived from Vin through a suitable voltage divider network

- CI1 4 x 0.047 μF (high-frequency decoupling capacitor)
- CI2 12 x 22 μF
- CI3 4 x 470 μF (polymer or electrolytic)
- CO1 4 x 0.047 μF (high-frequency decoupling capacitor)
- CO2 12 x 47 μF
- CO3 10 x 1000 μF
- RTune 3010Ω
- RTrim 5.9KΩ

Note: The DATA, CLK and SMBALRT pins do not have any pull-up resistors inside the module. Typically, the PMBus master controller will have pull-up resistors as well as provide the driving source for these signals.

If running the simulation at ge.transim.com remember to use bin 'a' parameters to determine the Loop Stability, and bin 'b' parameters to determine the transient response.

170A TeraDLynx™: Non-Isolated DC-DC Power Modules

7Vdc –14Vdc input; 0.6Vdc to 1.5Vdc output; 170A Output Current

Mechanical Outline (SMT)

Dimensions are in millimeters and (inches).

Tolerances: x.x mm ± 0.5 mm (x.xx in. ± 0.02 in.) [unless otherwise indicated]

x.xx mm ± 0.25 mm (x.xxx in ± 0.010 in.)

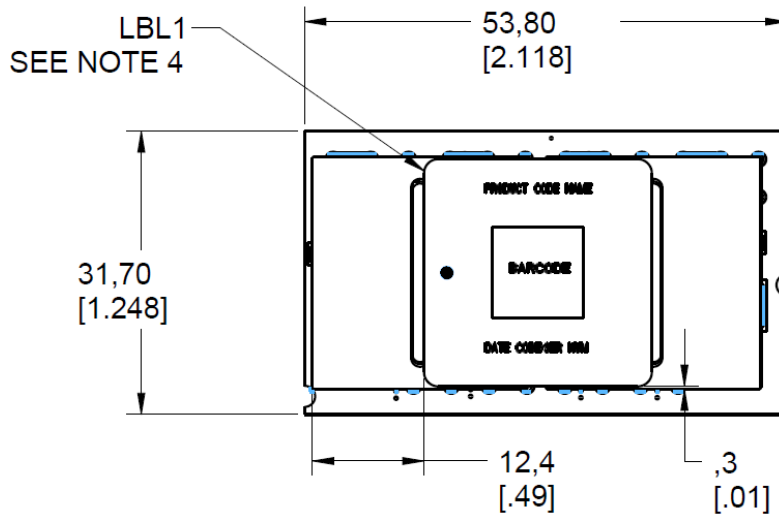

TOP VIEW

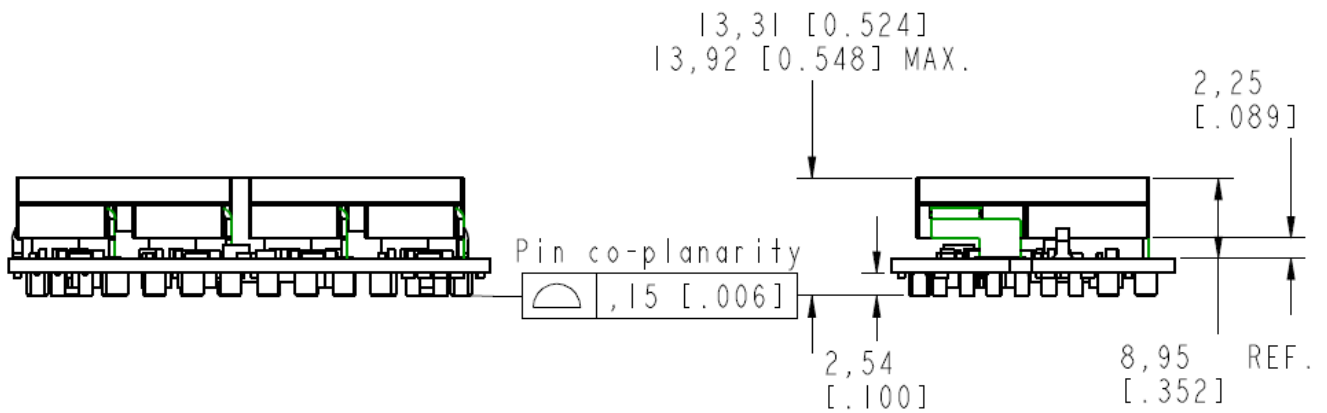

FRONT VIEW

SIDE VIEW

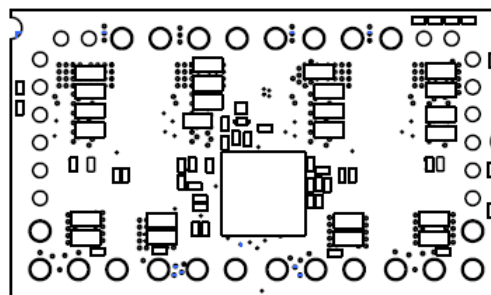

BOTTOM VIEW

170A TeraDLynx™: Non-Isolated DC-DC Power Modules

7Vdc –14Vdc input; 0.6Vdc to 1.5Vdc output; 170A Output Current

Recommended SMT Pad Layout

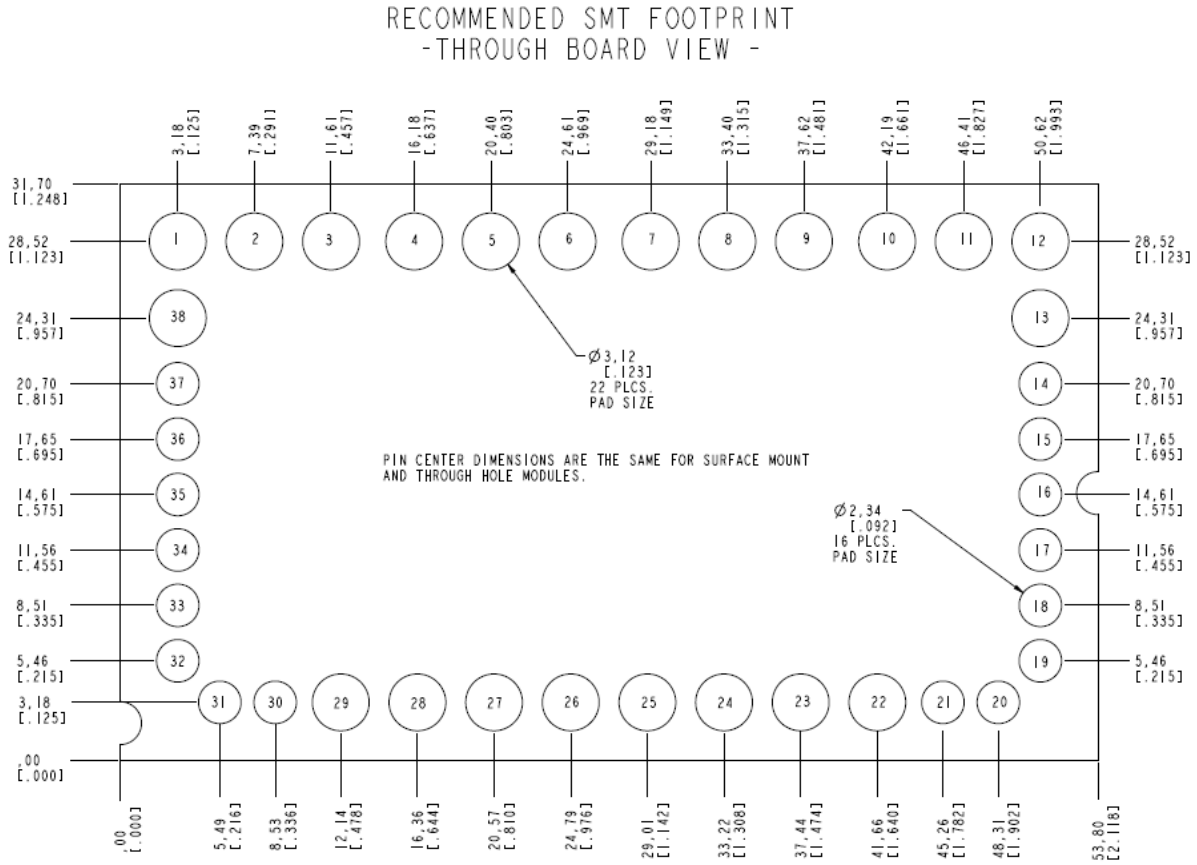

PIN	FUNCTION	PIN	FUNCTION	PIN	FUNCTION
1	VOUT**	15	PWR_GOOD	29	VIN
2	VOUT**	16	RTUNE	30	NC
3	GND**	17	TRIM	31	SHARE
4	VOUT**	18	SEQ	32	ON/OFF
5	VOUT**	19	SIG_GND*	33	SMBALERT#
6	GND**	20	VS+	34	DATA
7	VOUT**	21	VS-	35	CLK
8	VOUT**	22	GND**	36	ADDR0
9	GND**	23	VIN**	37	ADDR1
10	VOUT**	24	GND**	38	GND**
11	VOUT**	25	VIN**		
12	GND**	26	GND**		
13	GND**	27	VIN**		
14	SYNC	28	GND**		

(*) DO NOT connect SIG_GND to any other GND paths. It needs to be kept separate from other grounds on the board external to the module

(**) Vin, Vout and GND power pins must ALL be used in connection to respective application layout/circuitry to ensure optimum electrical and thermal operation of the high-power module.

170A TeraDlynx™: Non-Isolated DC-DC Power Modules

7Vdc –14Vdc input; 0.6Vdc to 1.5Vdc output; 170A Output Current

Mechanical Outline (Through hole)

Dimensions are in millimeters and (inches).

Tolerances: x.x mm ± 0.5 mm (x.xx in. ± 0.02 in.) [unless otherwise indicated]

x.xx mm ± 0.25 mm (x.xxx in ± 0.010 in.)

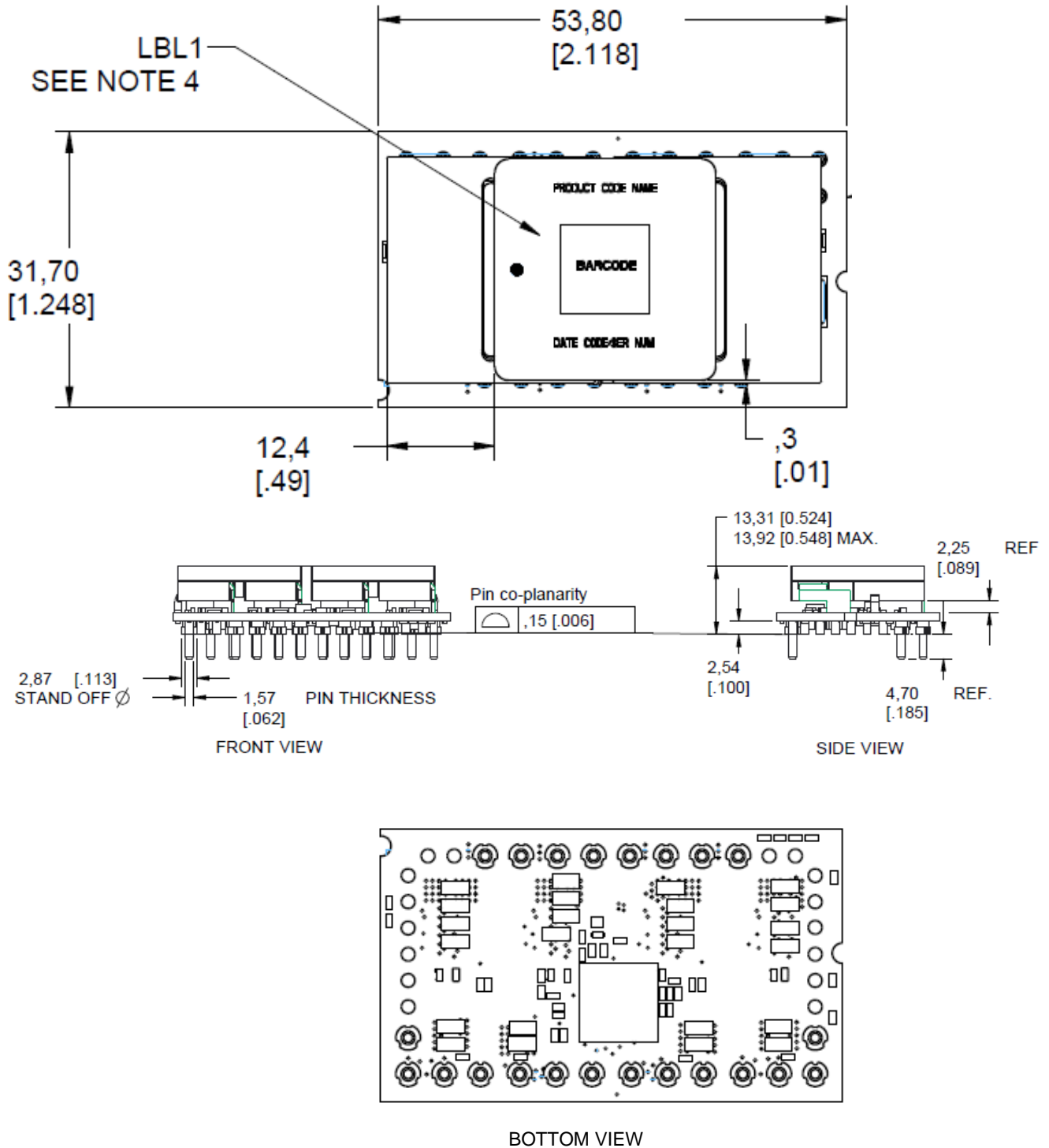

170A TeraDlynx™: Non-Isolated DC-DC Power Modules

7Vdc -14Vdc input; 0.6Vdc to 1.5Vdc output; 170A Output Current

Recommended Through-hole Layout

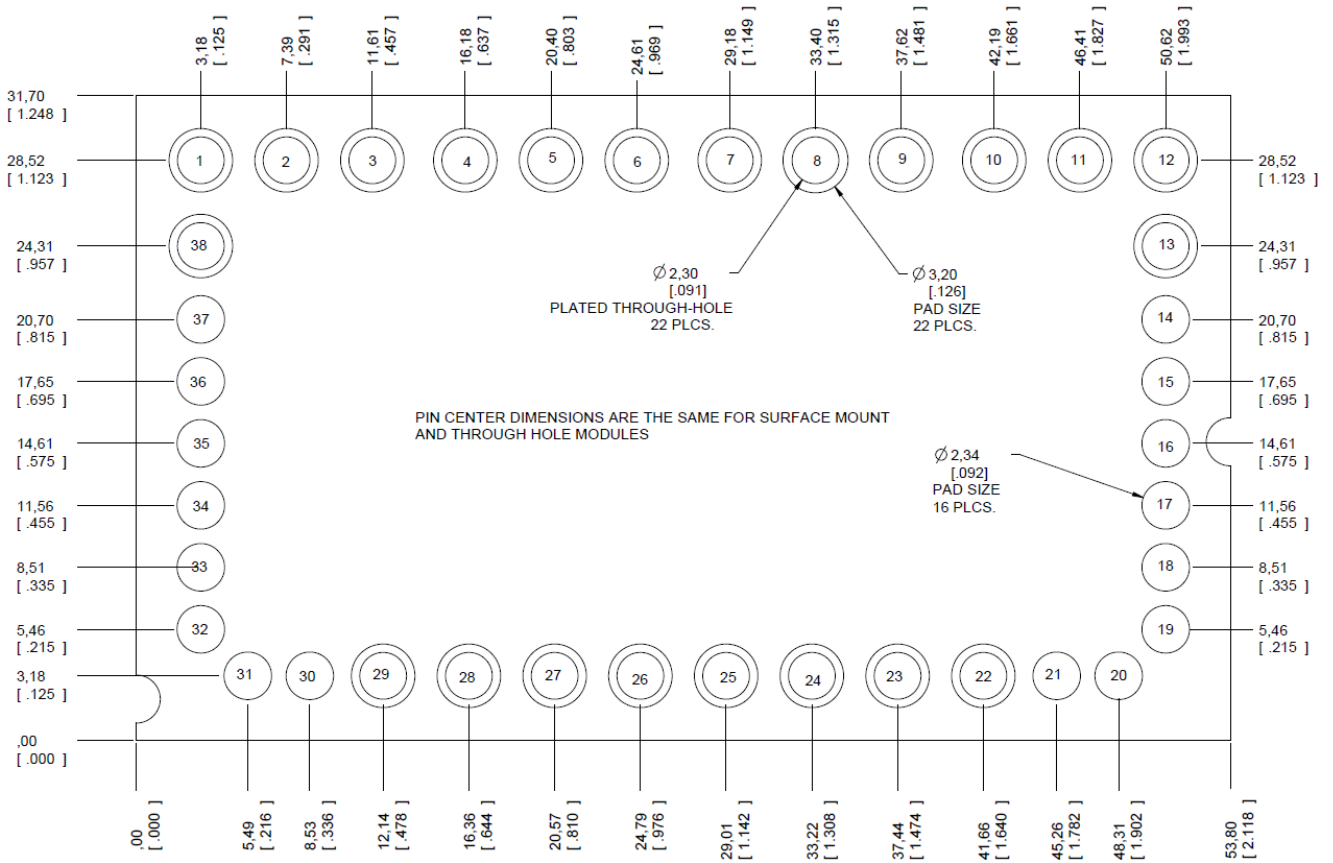

Note: In the Through-Hole version of the TJT170, pins 1-13, 22-29 and 38 are Through-Hole pins, pins 14-21, 30-37 are SMT pins. The drawing above shows the recommended layout as a combination of holes in the PWB to accommodate the Through-Hole pins and pads on the top layer to accommodate the SMT pins.

PIN	FUNCTION	PIN	FUNCTION	PIN	FUNCTION
1	VOUT	15	PWR_GOOD	29	VIN
2	VOUT	16	RTUNE	30	NC
3	GND	17	TRIM	31	SHARE
4	VOUT	18	SEQ	32	ON/OFF
5	VOUT	19	SIG_GND*	33	SMBALERT#
6	GND	20	VS+	34	DATA
7	VOUT	21	VS-	35	CLK
8	VOUT	22	GND	36	ADDR0
9	GND	23	VIN	37	ADDR1
10	VOUT	24	GND	38	GND
11	VOUT	25	VIN		
12	GND	26	GND		
13	GND	27	VIN		
14	SYNC	28	GND		

*Do not connect SIG_GND to any other GND paths. It needs to be kept separate from other grounds on the board external to the module

170A TeraDlynx™: Non-Isolated DC-DC Power Modules

7Vdc -14Vdc input; 0.6Vdc to 1.5Vdc output; 170A Output Current

Packaging Details

The 170A TeraDlynx™ modules are supplied in trays. Modules are shipped in quantities of 12 modules per layer, 24 per box. All Dimensions are in millimeters. All radius unspecified are R2.0mm. All angles unspecified are 5°.

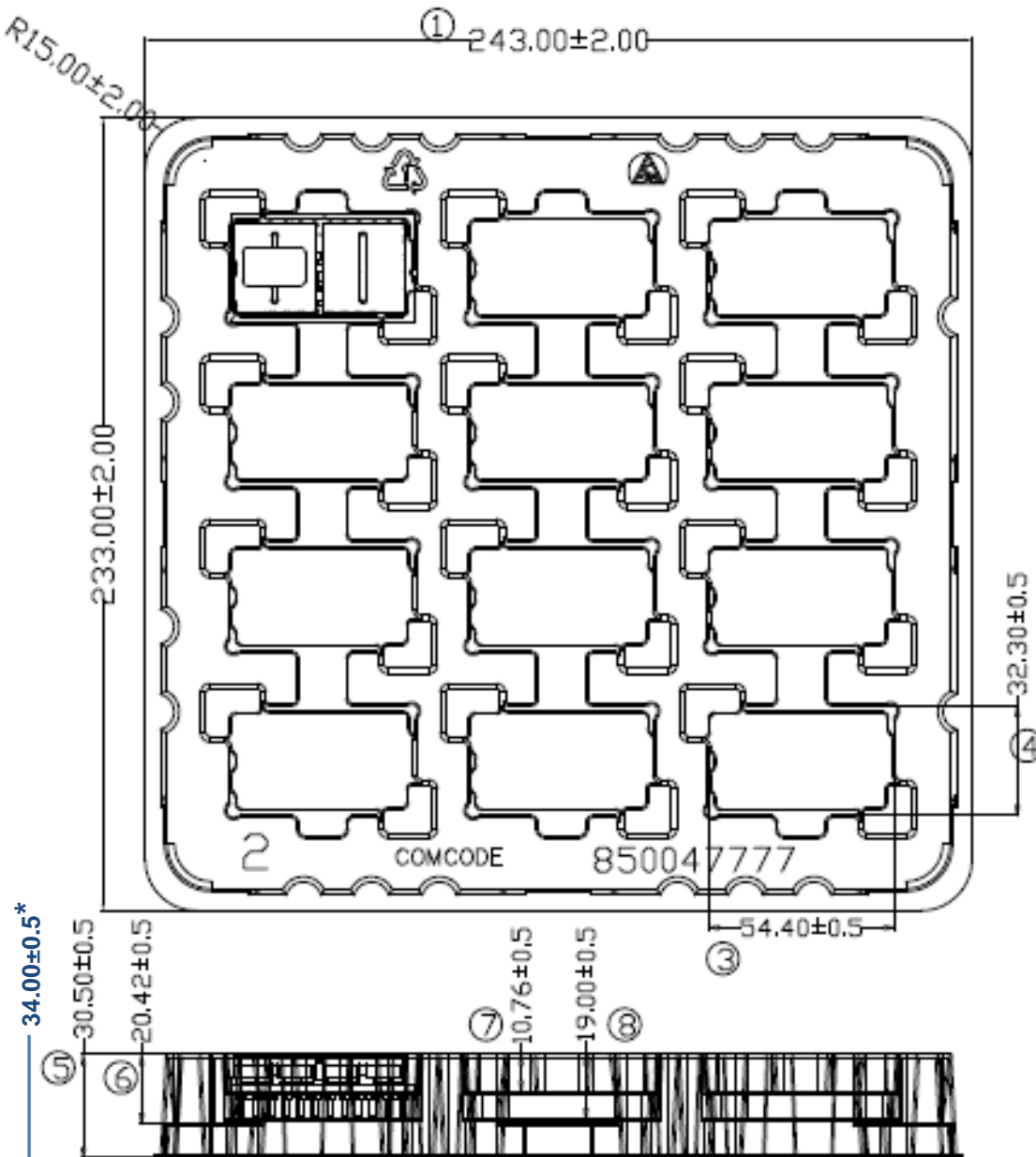

* Unit datecodes prior to 1802 will have the older taller tray with a height of 34.00±0.5 as indicated

170A TeraDLynx™: Non-Isolated DC-DC Power Modules

7Vdc –14Vdc input; 0.6Vdc to 1.5Vdc output; 170A Output Current

Surface Mount Information

Pick and Place

The 170A TeraDLynx™ modules use an open frame construction and are designed for a fully automated assembly process. The modules are fitted with a label designed to provide a large surface area for pick and place operations. The label meets all the requirements for surface mount processing, as well as safety standards, and is able to withstand reflow temperatures of up to 300°C. The label also carries product information such as product code, serial number and the location of manufacture.

Nozzle, Stencil Recommendations

The module weight has been kept to a minimum by using open frame construction. Variables such as nozzle size, tip style, vacuum pressure and placement speed should be considered to optimize this process. The minimum recommended inside nozzle diameter for reliable operation is 15mm. The maximum nozzle outer diameter, which will safely fit within the allowable component spacing, is 22 mm. The minimum stencil to be used should be larger than the modules co-planarity spec.

Bottom Side / First Side Assembly

This module is not recommended for assembly on the bottom side of a customer board. If such an assembly is attempted, components may fall off the module during the second reflow process.

Lead Free Soldering

The modules are lead-free (Pb-free) and RoHS compliant and fully compatible in a Pb-free soldering process. Failure to observe the instructions below may result in the failure of or cause damage to the modules and can adversely affect long-term reliability.

Pb-free Reflow Profile

Power Systems will comply with J-STD-020 Rev. C (Moisture/Reflow Sensitivity Classification for Nonhermetic Solid State Surface Mount Devices) for both Pb-free solder profiles and MSL classification procedures. This standard provides a recommended forced-air-convection reflow profile based on the volume and thickness of the package (table 4-2). The suggested Pb-free solder paste is Sn/Ag/Cu (SAC). The recommended linear reflow profile using Sn/Ag/Cu solder is shown in Fig. 40. Soldering outside of the recommended profile requires testing to verify results and performance.

MSL Rating

The 170A TeraDLynx™ modules have a MSL rating of 3.

Storage and Handling

The recommended storage environment and handling procedures for moisture-sensitive surface mount packages is detailed in J-STD-033 Rev. A (Handling, Packing, Shipping and Use of Moisture/Reflow Sensitive Surface Mount Devices). Moisture barrier bags (MBB) with desiccant are required for MSL ratings of 2 or greater. These sealed

packages should not be broken until time of use. Once the original package is broken, the floor life of the product at conditions of $\leq 30^\circ\text{C}$ and 60% relative humidity varies according to the MSL rating (see J-STD-033A). The shelf life for dry packed SMT packages will be a minimum of 12 months from the bag seal date, when stored at the following conditions: $< 40^\circ\text{C}$, $< 90\%$ relative humidity.

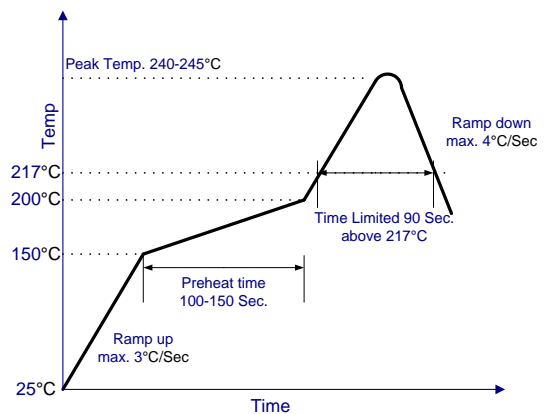

Figure 39. Recommended linear reflow profile using Sn/Ag/Cu solder.

Post Solder Cleaning and Drying Considerations

Post solder cleaning is usually the final circuit-board assembly process prior to electrical board testing. The result of inadequate cleaning and drying can affect both the reliability of a power module and the testability of the finished circuit-board assembly. For guidance on appropriate soldering, cleaning and drying procedures, refer to *Board Mounted Power Modules: Soldering and Cleaning* Application Note (AN04-001).

Through Hole Information

The 170A TeraDLynx™ modules are lead-free (Pb-free) and RoHS compliant and fully compatible in an Pb-free soldering process. For the through-hole application, it is recommended that the modules are assembled in the pin and paste reflow process, not in the wave solder process. Failure to observe the instructions below may result in the failure of or cause damage to the modules and can adversely affect long-term reliability.

170A TeraDLynx™: Non-Isolated DC-DC Power Modules

7Vdc –14Vdc input; 0.6Vdc to 1.5Vdc output; 170A Output Current

Ordering Information

Please contact your GE Sales Representative for pricing, availability and optional features.

Table 5. Device Codes

Device Code	Input Voltage Range	Output Voltage	Output Current	On/Off Logic	Interconnect	Comcodes
TJT170A0X3Z	7 – 14Vdc	0.6 – 1.5 Vdc	170A	Negative	TH	150043981
TJT170A0X43Z	7 – 14Vdc	0.6 – 1.5 Vdc	170A	Positive	TH	150049605
TJT170A0X3-SZ	7 – 14Vdc	0.6 – 1.5 Vdc	170A	Negative	SMT	150041744
TJT170A0X43-SZ	7 – 14Vdc	0.6 – 1.5 Vdc	170A	Positive	SMT	150049607

-Z refers to RoHS compliant parts

Table 6. Coding Scheme

Package Identifier	Family	Sequencing Option	Output current	Output voltage	On/Off logic	Remote Sense	Options		ROHS Compliance
T	J	T	170A0	X		3	-SR	-H	Z
P=Pico U=Micro M=Mega G=Giga T=Tera	J = DLynx II	T=with EZ Sequence X=without sequencing	170A	X = programm able output	4 = positive No entry = negative	3 = Remote Sense	S = Surface Mount R = Tape & Reel No entry = Through hole	Extra Ground Pins	Z = ROHS6

GE Digital Non-Isolated DC-DC products use technology licensed from Power-One, protected by US patents: US20040246754, US2004090219A1, US2004093533A1, US2004123164A1, US2004123167A1, US2004178780A1, US2004179382A1, US20050200344, US20050223252, US2005289373A1, US20060061214, US2006015616A1, US20060174145, US20070226526, US20070234095, US20070240000, US20080052551, US20080072080, US20080186006, US6741099, US6788036, US6936999, US6949916, US7000125, US7049798, US7068021, US7080265, US7249267, US7266709, US7315156, US7372682, US7373527, US7394445, US7456617, US7459892, US7493504, US7526660.

Outside the US the Power-One licensed technology is protected by patents: AU3287379AA, AU3287437AA, AU3290643AA, AU3291357AA, CN10371856C, CN10452610C, CN10458656C, CN10459360C, CN10465848C, CN11069332A, CN11124619A, CN11346682A, CN1685299A, CN1685459A, CN1685582A, CN1685583A, CN1698023A, CN1802619A, EP1561156A1, EP1561268A2, EP1576710A1, EP1576711A1, EP1604254A4, EP1604264A4, EP1714369A2, EP1745536A4, EP1769382A4, EP1899789A2, EP1984801A2, W004044718A1, W004045042A3, W004045042C1, W004062061 A1, W004062062A1, W004070780A3, W004084390A3, W004084391A3, W005079227A3, W005081771A3, W006019569A3, W02007001584A3, W02007094935A3

Contact Us

For more information, call us at

USA/Canada:

+1 888 546 3243, or +1 972 244 9288

Asia-Pacific:

+86.021.54279977*808

Europe, Middle-East and Africa:

+49.89.878067-280



www.gecriticalpower.com

GE Critical Power reserves the right to make changes to the product(s) or information contained herein without notice, and no liability is assumed as a result of their use or application. No rights under any patent accompany the sale of any such product(s) or information.

Компания «Океан Электроники» предлагает заключение долгосрочных отношений при поставках импортных электронных компонентов на взаимовыгодных условиях!

Наши преимущества:

- Поставка оригинальных импортных электронных компонентов напрямую с производств Америки, Европы и Азии, а так же с крупнейших складов мира;
- Широкая линейка поставок активных и пассивных импортных электронных компонентов (более 30 млн. наименований);
- Поставка сложных, дефицитных, либо снятых с производства позиций;
- Оперативные сроки поставки под заказ (от 5 рабочих дней);
- Экспресс доставка в любую точку России;
- Помощь Конструкторского Отдела и консультации квалифицированных инженеров;
- Техническая поддержка проекта, помощь в подборе аналогов, поставка прототипов;
- Поставка электронных компонентов под контролем ВП;
- Система менеджмента качества сертифицирована по Международному стандарту ISO 9001;
- При необходимости вся продукция военного и аэрокосмического назначения проходит испытания и сертификацию в лаборатории (по согласованию с заказчиком);
- Поставка специализированных компонентов военного и аэрокосмического уровня качества (Xilinx, Altera, Analog Devices, Intersil, Interpoint, Microsemi, Actel, Aeroflex, Peregrine, VPT, Syfer, Eurofarad, Texas Instruments, MS Kennedy, Miteq, Cobham, E2V, MA-COM, Hittite, Mini-Circuits, General Dynamics и др.);

Компания «Океан Электроники» является официальным дистрибьютором и эксклюзивным представителем в России одного из крупнейших производителей разъемов военного и аэрокосмического назначения «JONHON», а так же официальным дистрибьютором и эксклюзивным представителем в России производителя высокотехнологичных и надежных решений для передачи СВЧ сигналов «FORSTAR».



JONHON

«JONHON» (основан в 1970 г.)

Разъемы специального, военного и аэрокосмического назначения:

(Применяются в военной, авиационной, аэрокосмической, морской, железнодорожной, горно- и нефтедобывающей отраслях промышленности)

«FORSTAR» (основан в 1998 г.)

ВЧ соединители, коаксиальные кабели, кабельные сборки и микроволновые компоненты:

(Применяются в телекоммуникациях гражданского и специального назначения, в средствах связи, РЛС, а так же военной, авиационной и аэрокосмической отраслях промышленности).



Телефон: 8 (812) 309-75-97 (многоканальный)

Факс: 8 (812) 320-03-32

Электронная почта: ocean@oceanchips.ru

Web: <http://oceanchips.ru/>

Адрес: 198099, г. Санкт-Петербург, ул. Калинина, д. 2, корп. 4, лит. А