



NBM™ Bus Converter

NBM6123x46C15A6yzz



Non-Isolated, Fixed Ratio DC-DC Converter

Features

- Up to 160 A continuous output current
- 3532 W/in³ power density
- Parallel operation for multi-kW arrays
- OV, OC, UV, short circuit and thermal protection
- 6123 through-hole ChiP package
 - 2.402" x 0.990" x 0.286"
(61.00 mm x 25.14 mm x 7.26 mm)

Typical Applications

- DC Power Distribution
- High End Computing Systems
- Automated Test Equipment
- Industrial Systems
- High Density Power Supplies
- Communications Systems
- Transportation

Product Ratings

$V_{PRI} = 42 \text{ V (36 - 46 V)}$	$P_{SEC} = \text{up to } 2400 \text{ W}$
$V_{SEC} = 14 \text{ V (12.0 - 15.3 V)}$ (NO LOAD)	$K = 1/3$

Product Description

The VI Chip® Non-Isolated Bus Converter (NBM™) is a high efficiency Sine Amplitude Converter™ (SAC™), operating from a 36 to 46 VDC primary bus to deliver a non-isolated, ratiometric output from 12.0 to 15.3 VDC.

The NBM6123x46C15A6yzz offers low noise, fast transient response, and industry leading efficiency and power density. In addition, it provides an AC impedance beyond the bandwidth of most downstream regulators, allowing input capacitance normally located at the input of a POL regulator to be located at the primary side of the NBM module. With a primary to secondary K factor of 1/3, that capacitance value can be reduced by a factor of 9x, resulting in savings of board area, material and total system cost.

Leveraging the thermal and density benefits of Vicor's ChiP packaging technology, the NBM module offers flexible thermal management options with very low top and bottom side thermal impedances. Thermally-adept ChiP-based power components, enable customers to achieve low cost power system solutions with previously unattainable system size, weight and efficiency attributes, quickly and predictably.

The NBM non-isolated topology allows operation in forward and reverse directions and provides bidirectional protections. However if power train is disabled by any protection, and V_{SEC} is present, then voltage equal to V_{SEC} minus two diode drops will appear on primary side.

Typical Application

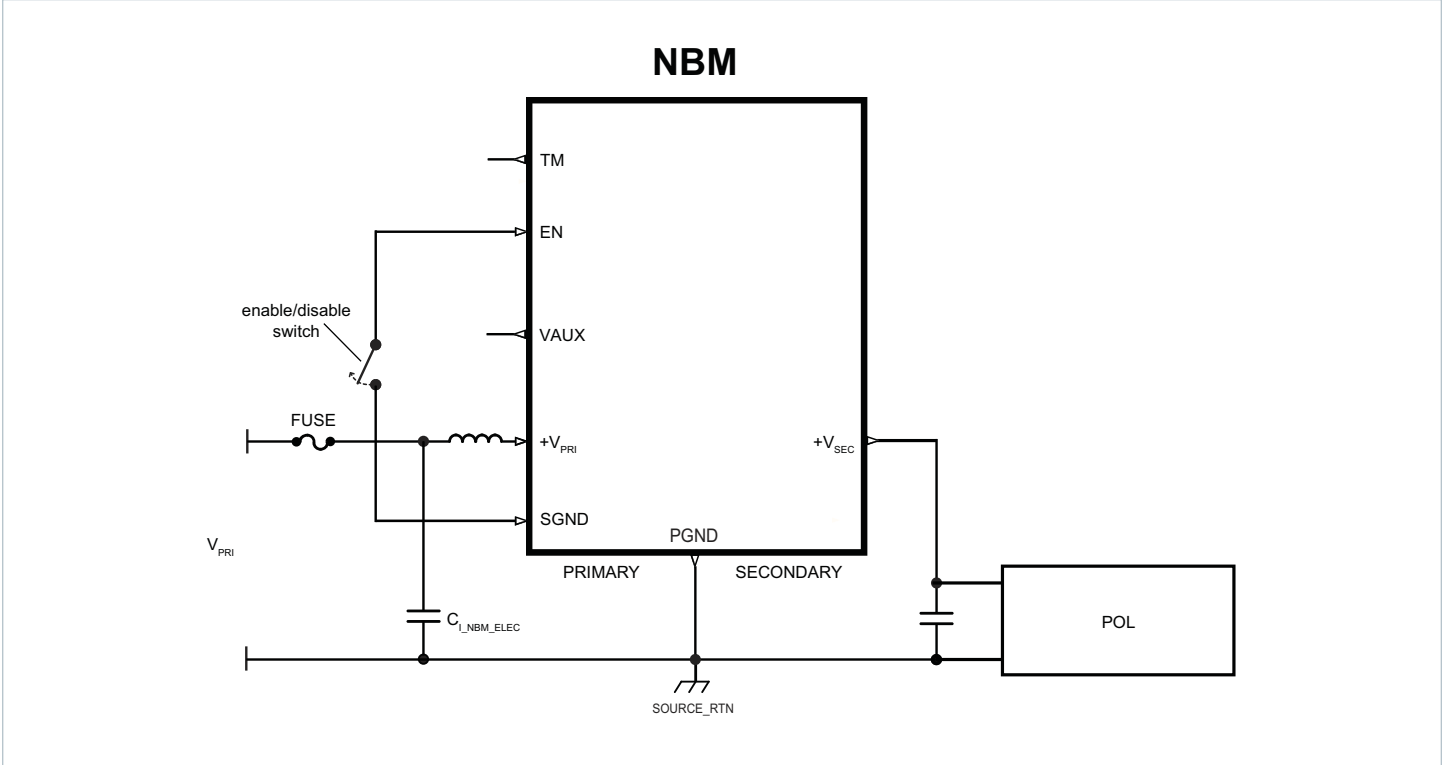

NBM6123x46C15A6yzz+ Point of Load

Pin Configuration

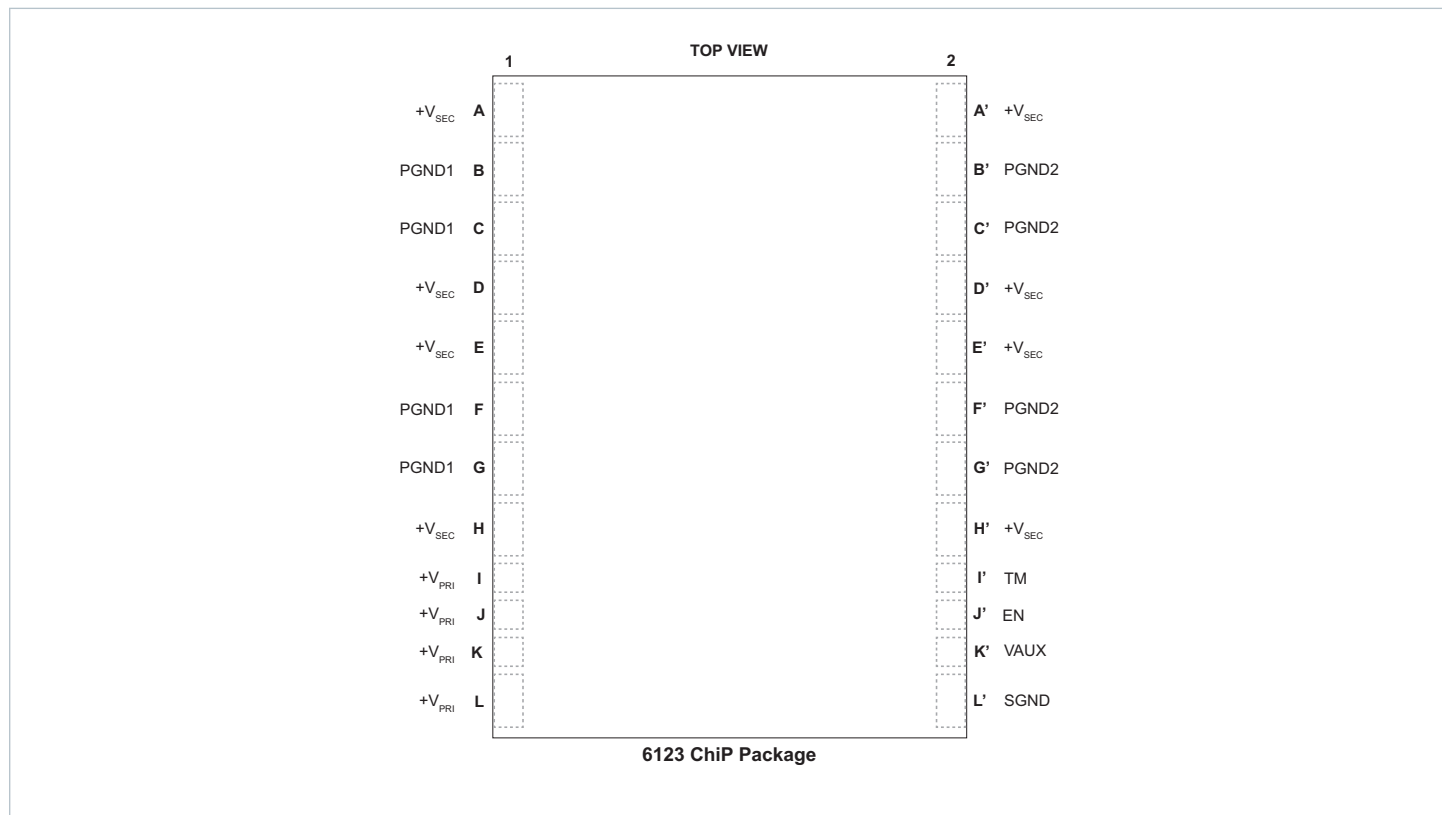

Pin Descriptions

Pin Number	Signal Name	Type	Function
I1, J1, K1, L1	+V _{PRI}	PRIMARY POWER	Positive primary transformer power terminal
I'2	TM	OUTPUT	Temperature Monitor; Primary side referenced signals
J'2	EN	INPUT	Enables and disables power supply; Primary side referenced signals
K'2	VAUX	OUTPUT	Auxiliary Voltage Source; Primary side referenced signals
L'2	SGND	SIGNAL RETURN	Signal return terminal only. Do not connect to PGND
A1, D1, E1, H1, A'2, D'2, E'2, H'2	+V _{SEC}	SECONDARY POWER	Positive secondary transformer power terminal
B1, C1, F1, G1 B'2, C'2, F'2, G'2	PGND*	SECONDARY POWER RETURN	Transformer power return terminal

*For proper operation an external low impedance connection must be made between listed -PGND1 and PGND2 terminals.

Part Ordering Information

Product Function	Package Size	Package Mounting	Max Primary Input Voltage	Range Identifier	Max Secondary Voltage	Secondary Output Current	Temperature Grade	Option
NBM	6123	x	46	C	15	A6	y	zz
Non-isolated Bus Converter Module	61 = L 23 = W	T = TH S = SMT	46 V	36 – 46 V	15 V No Load	160 A	T = -40°C – 125°C M = -55°C – 125°C	00 = Analog Ctrl 01 = PMBus Ctrl 0R = Reversible Analog Ctrl 0P = Reversible PMBus Ctrl

All products shipped in JEDEC standard high profile (0.400" thick) trays (JEDEC Publication 95, Design Guide 4.10).

Standard Models

Product Function	Package Size	Package Mounting	Max Primary Input Voltage	Range Identifier	Max Secondary Voltage	Secondary Output Current	Temperature Grade	Option
NBM	6123	T	46	C	15	A6	T	0R

Absolute Maximum Ratings

The absolute maximum ratings below are stress ratings only. Operation at or beyond these maximum ratings can cause permanent damage to the device.

Parameter	Comments	Min	Max	Unit
+V _{PRI_DC} to -V _{PRI_DC}		-1	60	V
V _{PRI_DC} or V _{SEC_DC} slew rate (operational)			1	V/μs
+V _{SEC_DC} to -V _{SEC_DC}		-1	20	V
TM to -V _{PRI_DC}		-0.3	4.6	V
EN to -V _{PRI_DC}			5.5	V
VAUX to -V _{PRI_DC}			4.6	V

Electrical Specifications

Specifications apply over all line and load conditions, unless otherwise noted; **Boldface** specifications apply over the temperature range of $-40^{\circ}\text{C} \leq T_{\text{INTERNAL}} \leq 125^{\circ}\text{C}$ (T-Grade); All other specifications are at $T_{\text{INTERNAL}} = 25^{\circ}\text{C}$ unless otherwise noted.

Attribute	Symbol	Conditions / Notes	Min	Typ	Max	Unit	
General Powetrain PRIMARY to SECONDARY Specification (Forward Direction)							
Primary Input Voltage range, continuous	$V_{\text{PRI_DC}}$		36		46	V	
V_{PRI} μ Controller	$V_{\mu\text{C_ACTIVE}}$	$V_{\text{PRI_DC}}$ voltage where μC is initialized, (ie VAUX = Low, powertrain inactive)			15	V	
PRI to SEC Input Quiescent Current	$I_{\text{PRI_Q}}$	Disabled, EN Low, $V_{\text{PRI_DC}} = 42\text{ V}$ $T_{\text{INTERNAL}} \leq 100^{\circ}\text{C}$		8		mA	
					12		
PRI to SEC No Load Power Dissipation	$P_{\text{PRI_NL}}$	$V_{\text{PRI_DC}} = 42\text{ V}$, $T_{\text{INTERNAL}} = 25^{\circ}\text{C}$		12.5	19.5	W	
		$V_{\text{PRI_DC}} = 42\text{ V}$	5		28		
		$V_{\text{PRI_DC}} = 36\text{ V to }46\text{ V}$, $T_{\text{INTERNAL}} = 25^{\circ}\text{C}$					22
		$V_{\text{PRI_DC}} = 36\text{ V to }46\text{ V}$					31
PRI to SEC Inrush Current Peak	$I_{\text{PRI_INR_PK}}$	$V_{\text{PRI_DC}} = 46\text{ V}$, $C_{\text{SEC_EXT}} = 3000\ \mu\text{F}$, $R_{\text{LOAD_SEC}} = 20\%$ of full load current		30		A	
		$T_{\text{INTERNAL}} \leq 100^{\circ}\text{C}$					75
DC Primary Input Current	$I_{\text{PRI_IN_DC}}$	At $I_{\text{SEC_OUT_DC}} = 160\text{ A}$, $T_{\text{INTERNAL}} \leq 100^{\circ}\text{C}$			53.9	A	
Transformation Ratio	K	Primary to secondary, $K = V_{\text{SEC_DC}} / V_{\text{PRI_DC}}$, at no load		1/3		V/V	
Secondary Output Power (continuous)	$P_{\text{SEC_OUT_DC}}$	Specified at $V_{\text{PRI_DC}} = 46\text{ V}$			2400	W	
Secondary Output Power (pulsed)	$P_{\text{SEC_OUT_PULSE}}$	Specified at $V_{\text{PRI_DC}} = 46\text{ V}$; 10 ms pulse, 25% Duty cycle, $P_{\text{SEC_AVG}} = 50\%$ rated $P_{\text{SEC_OUT_DC}}$			2650	W	
Secondary Output Current (continuous)	$I_{\text{SEC_OUT_DC}}$				160	A	
Secondary Output Current (pulsed)	$I_{\text{SEC_OUT_PULSE}}$	10 ms pulse, 25% Duty cycle, $I_{\text{SEC_OUT_AVG}} = 50\%$ rated $I_{\text{SEC_OUT_DC}}$			176	A	
PRI to SEC Efficiency (ambient)	η_{AMB}	$V_{\text{PRI_DC}} = 42\text{ V}$, $I_{\text{SEC_OUT_DC}} = 160\text{ A}$	97.4	98		%	
		$V_{\text{PRI_DC}} = 36\text{ V to }46\text{ V}$, $I_{\text{SEC_OUT_DC}} = 160\text{ A}$	97.1				
		$V_{\text{PRI_DC}} = 42\text{ V}$, $I_{\text{SEC_OUT_DC}} = 80\text{ A}$	97.5	98.2			
PRI to SEC Efficiency (hot)	η_{HOT}	$V_{\text{PRI_DC}} = 42\text{ V}$, $I_{\text{SEC_OUT_DC}} = 160\text{ A}$	96.9	97.4		%	
PRI to SEC Efficiency (over load range)	$\eta_{20\%}$	$32\text{ A} < I_{\text{SEC_OUT_DC}} < 160\text{ A}$	90			%	
PRI to SEC Output Resistance	$R_{\text{SEC_COLD}}$	$V_{\text{PRI_DC}} = 42\text{ V}$, $I_{\text{SEC_OUT_DC}} = 160\text{ A}$, $T_{\text{INTERNAL}} = -40^{\circ}\text{C}$	0.8	0.95	1.1	m Ω	
	$R_{\text{SEC_AMB}}$	$V_{\text{PRI_DC}} = 42\text{ V}$, $I_{\text{SEC_OUT_DC}} = 160\text{ A}$	0.9	1.3	1.7		
	$R_{\text{SEC_HOT}}$	$V_{\text{PRI_DC}} = 42\text{ V}$, $I_{\text{SEC_OUT_DC}} = 160\text{ A}$, $T_{\text{INTERNAL}} = 100^{\circ}\text{C}$	1.5	1.75	2.0		
Switching Frequency	F_{SW}	Frequency of the Output Voltage Ripple = $2 \times F_{\text{SW}}$	1.14	1.20	1.26	MHz	
Secondary Output Voltage Ripple	$V_{\text{SEC_OUT_PP}}$	$C_{\text{SEC_EXT}} = 0\ \mu\text{F}$, $I_{\text{SEC_OUT_DC}} = 160\text{ A}$, $V_{\text{PRI_DC}} = 42\text{ V}$, 20 MHz BW		110		mV	
		$T_{\text{INTERNAL}} \leq 100^{\circ}\text{C}$					205
Primary Input Leads Inductance (Parasitic)	$L_{\text{PRI_IN_LEADS}}$	Frequency 2.5 MHz (double switching frequency), Simulated lead model		3		nH	
Secondary Output Leads Inductance (Parasitic)	$L_{\text{SEC_OUT_LEADS}}$	Frequency 2.5 MHz (double switching frequency), Simulated lead model		0.64		nH	

Electrical Specifications (Cont.)

Specifications apply over all line and load conditions, unless otherwise noted; **Boldface** specifications apply over the temperature range of $-40^{\circ}\text{C} \leq T_{\text{INTERNAL}} \leq 125^{\circ}\text{C}$ (T-Grade); All other specifications are at $T_{\text{INTERNAL}} = 25^{\circ}\text{C}$ unless otherwise noted.

Attribute	Symbol	Conditions / Notes	Min	Typ	Max	Unit
General Powetrain PRIMARY to SECONDARY Specification (Forward Direction) Cont.						
Effective Primary Capacitance (Internal)	$C_{\text{PRI_INT}}$	Effective Value at $42 V_{\text{PRI_DC}}$		16.8		μF
Effective Secondary Capacitance (Internal)	$C_{\text{SEC_INT}}$	Effective Value at $14 V_{\text{SEC_DC}}$		140		μF
Effective Secondary Output Capacitance (External)	$C_{\text{SEC_OUT_EXT}}$	Excessive capacitance may drive module into SC protection			3000	μF
Effective Secondary Output Capacitance (External)	$C_{\text{SEC_OUT_AEXT}}$	$C_{\text{SEC_OUT_AEXT MAX}} = N * 0.5 * C_{\text{SEC_OUT_EXT MAX}}$, where N = the number of units in parallel				
Protection PRIMARY to SECONDARY (Forward Direction)						
Auto Restart Time	$t_{\text{AUTO_RESTART}}$	Startup into a persistent fault condition. Non-Latching fault detection given $V_{\text{PRI_DC}} > V_{\text{PRI_UVLO+}}$	940		1010	ms
Primary Overvoltage Lockout Threshold	$V_{\text{PRI_OVLO+}}$		48	50	52	V
Primary Overvoltage Recovery Threshold	$V_{\text{PRI_OVLO-}}$		46	48	50	V
Primary Overvoltage Lockout Hysteresis	$V_{\text{PRI_OVLO_HYST}}$			2		V
Primary Overvoltage Lockout Response Time	$t_{\text{PRI_OVLO}}$			30		μs
Primary Undervoltage Lockout Threshold	$V_{\text{PRI_UVLO-}}$		28	30	32	V
Primary Undervoltage Recovery Threshold	$V_{\text{PRI_UVLO+}}$		30	32	34	V
Primary Undervoltage Lockout Hysteresis	$V_{\text{PRI_UVLO_HYST}}$			2		V
Primary Undervoltage Lockout Response Time	$t_{\text{PRI_UVLO}}$			100		μs
Primary Undervoltage Startup Delay	$t_{\text{PRI_UVLO+_DELAY}}$	From $V_{\text{PRI_DC}} = V_{\text{PRI_UVLO+}}$ to powertrain active, EN floating, (i.e One time Startup delay form application of $V_{\text{PRI_DC}}$ to $V_{\text{SEC_DC}}$)		30		ms
Primary Soft-Start Time	$t_{\text{PRI_SOFT-START}}$	From powertrain active. Fast Current limit protection disabled during Soft-Start		1		ms
Secondary Output Overcurrent Trip Threshold	$I_{\text{SEC_OUT_OCP}}$		177	200	240	A
Secondary Output Overcurrent Response Time Constant	$t_{\text{SEC_OUT_OCP}}$	Effective internal RC filter		4		ms
Secondary Output Short Circuit Protection Trip Threshold	$I_{\text{SEC_OUT_SCP}}$		240			A
Secondary Output Short Circuit Protection Response Time	$t_{\text{SEC_OUT_SCP}}$			1		μs
Overtemperature Shutdown Threshold	$t_{\text{OTP+}}$	Temperature sensor located inside controller IC	125			$^{\circ}\text{C}$
Overtemperature Recovery Threshold	$t_{\text{OTP-}}$		105	110	115	$^{\circ}\text{C}$
Undertemperature Shutdown Threshold	t_{UTP}	Temperature sensor located inside controller IC; Protection not available for M-Grade units.			-45	$^{\circ}\text{C}$
Undertemperature Restart Time	$t_{\text{UTP_RESTART}}$	Startup into a persistent fault condition. Non-Latching fault detection given $V_{\text{PRI_DC}} > V_{\text{PRI_UVLO+}}$		3		s

Electrical Specifications (Cont.)

Specifications apply over all line and load conditions, unless otherwise noted; **Boldface** specifications apply over the temperature range of $-40^{\circ}\text{C} \leq T_{\text{INTERNAL}} \leq 125^{\circ}\text{C}$ (T-Grade); All other specifications are at $T_{\text{INTERNAL}} = 25^{\circ}\text{C}$ unless otherwise noted.

Attribute	Symbol	Conditions / Notes	Min	Typ	Max	Unit
General Powetrain SECONDARY to PRIMARY Specification (Reverse Direction)						
Secondary Input Voltage range, continuous	$V_{\text{SEC_DC}}$		12		15.3	V
SEC to PRI No Load Power Dissipation	$P_{\text{SEC_NL}}$	$V_{\text{SEC_DC}} = 14\text{ V}$, $T_{\text{INTERNAL}} = 25^{\circ}\text{C}$		12.5	20	W
		$V_{\text{SEC_DC}} = 14\text{ V}$	5		29	
		$V_{\text{SEC_DC}} = 12\text{ V to } 15.3\text{ V}$, $T_{\text{INTERNAL}} = 25^{\circ}\text{C}$			22	
		$V_{\text{SEC_DC}} = 12\text{ V to } 15.3\text{ V}$			31	
DC Secondary Input Current	$I_{\text{SEC_IN_DC}}$	At $I_{\text{PRI_DC}} = 53.3\text{ A}$, $T_{\text{INTERNAL}} \leq 100^{\circ}\text{C}$			162	A
Primary Output Power (continuous)	$P_{\text{PRI_OUT_DC}}$	Specified at $V_{\text{SEC_DC}} = 15.3\text{ V}$			2400	W
Primary Output Power (pulsed)	$P_{\text{PRI_OUT_PULSE}}$	Specified at $V_{\text{SEC_DC}} = 15.3\text{ V}$; 10 ms pulse, 25% Duty cycle, $P_{\text{PRI_AVG}} = 50\%$ rated $P_{\text{PRI_OUT_DC}}$			2650	W
Primary Output Current (continuous)	$I_{\text{PRI_OUT_DC}}$				53.3	A
Primary Output Current (pulsed)	$I_{\text{PRI_OUT_PULSE}}$	10 ms pulse, 25% Duty cycle, $I_{\text{PRI_OUT_AVG}} = 50\%$ rated $I_{\text{PRI_OUT_DC}}$			58.7	A
		$V_{\text{SEC_DC}} = 14\text{ V}$, $I_{\text{PRI_OUT_DC}} = 53.3\text{ A}$	97	98		%
		$V_{\text{SEC_DC}} = 12\text{ V to } 15.3\text{ V}$, $I_{\text{PRI_OUT_DC}} = 53.3\text{ A}$	96.7			
$V_{\text{SEC_DC}} = 14\text{ V}$, $I_{\text{PRI_OUT_DC}} = 26.7\text{ A}$	97.6	98.3				
SEC to PRI Efficiency (hot)	η_{HOT}	$V_{\text{SEC_DC}} = 14\text{ V}$, $I_{\text{PRI_OUT_DC}} = 53.3\text{ A}$	96.6	97		%
SEC to PRI Efficiency (over load range)	$\eta_{20\%}$	$10.66\text{ A} < I_{\text{PRI_OUT_DC}} < 53.3\text{ A}$	90			%
SEC to PRI Output Resistance	$R_{\text{PRI_COLD}}$	$V_{\text{SEC_DC}} = 14\text{ V}$, $I_{\text{PRI_OUT_DC}} = 53.3\text{ A}$, $T_{\text{INTERNAL}} = -40^{\circ}\text{C}$	10	12	14	m Ω
	$R_{\text{PRI_AMB}}$	$V_{\text{SEC_DC}} = 14\text{ V}$, $I_{\text{PRI_OUT_DC}} = 53.3\text{ A}$	12	16	20	
	$R_{\text{PRI_HOT}}$	$V_{\text{SEC_DC}} = 14\text{ V}$, $I_{\text{PRI_OUT_DC}} = 53.3\text{ A}$, $T_{\text{INTERNAL}} = 100^{\circ}\text{C}$	16	19	22	
Primary Output Voltage Ripple	$V_{\text{PRI_OUT_PP}}$	$C_{\text{PRI_OUT_EXT}} = 0\text{ }\mu\text{F}$, $I_{\text{PRI_OUT_DC}} = 53.3\text{ A}$, $V_{\text{SEC_DC}} = 14\text{ V}$, 20 MHz BW		330		mV
		$T_{\text{INTERNAL}} \leq 100^{\circ}\text{C}$			615	

Electrical Specifications (Cont.)

Specifications apply over all line and load conditions, unless otherwise noted; **Boldface** specifications apply over the temperature range of $-40^{\circ}\text{C} \leq T_{\text{INTERNAL}} \leq 125^{\circ}\text{C}$ (T-Grade); All other specifications are at $T_{\text{INTERNAL}} = 25^{\circ}\text{C}$ unless otherwise noted.

Attribute	Symbol	Conditions / Notes	Min	Typ	Max	Unit
Protection SECONDARY to PRIMARY (Reverse Direction)						
Effective Primary Output Capacitance (External)	$C_{\text{PRI_OUT_EXT}}$	Excessive capacitance may drive module into SC protection when starting from Secondary to Primary			300	μF
Secondary Overvoltage Lockout Threshold	$V_{\text{SEC_OVLO+}}$		16	16.7	17.4	V
Secondary Overvoltage Recovery Threshold	$V_{\text{PRI_OVLO-}}$		15.3	16	16.7	V
Secondary Overvoltage Lockout Response Time	$t_{\text{PRI_OVLO}}$			30		μs
Secondary Undervoltage Lockout Threshold	$V_{\text{SEC_UVLO-}}$		9.3	10	10.7	V
Secondary Undervoltage Recovery Threshold	$V_{\text{PRI_UVLO+}}$		10	10.7	11.4	V
Secondary Undervoltage Lockout Response Time	$t_{\text{SEC_UVLO}}$			100		μs
Primary Output Overcurrent Trip Threshold	$I_{\text{PRI_OUT_OCP}}$	Powertrain is stopped but current can flow from Secondary to Primary through MOSFET body Diodes	59	66.7	80	A
Primary Output Overcurrent Response Time Constant	$t_{\text{PRI_OUT_OCP}}$	Effective internal RC filter		4		ms
Primary Short Circuit Protection Trip Threshold	$I_{\text{PRI_SCP}}$	Powertrain is stopped but current can flow from Secondary to Primary through MOSFET body Diodes	80			A
Primary Short Circuit Protection Response Time	$t_{\text{PRI_SCP}}$			1		μs

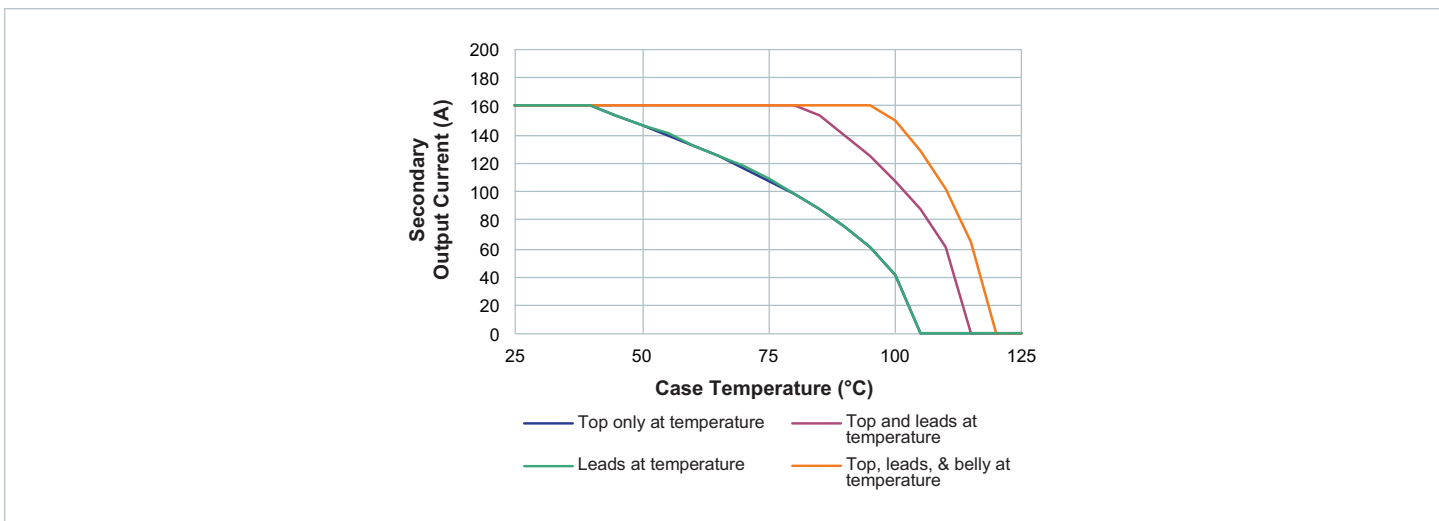

Figure 1 — Specified thermal operating area

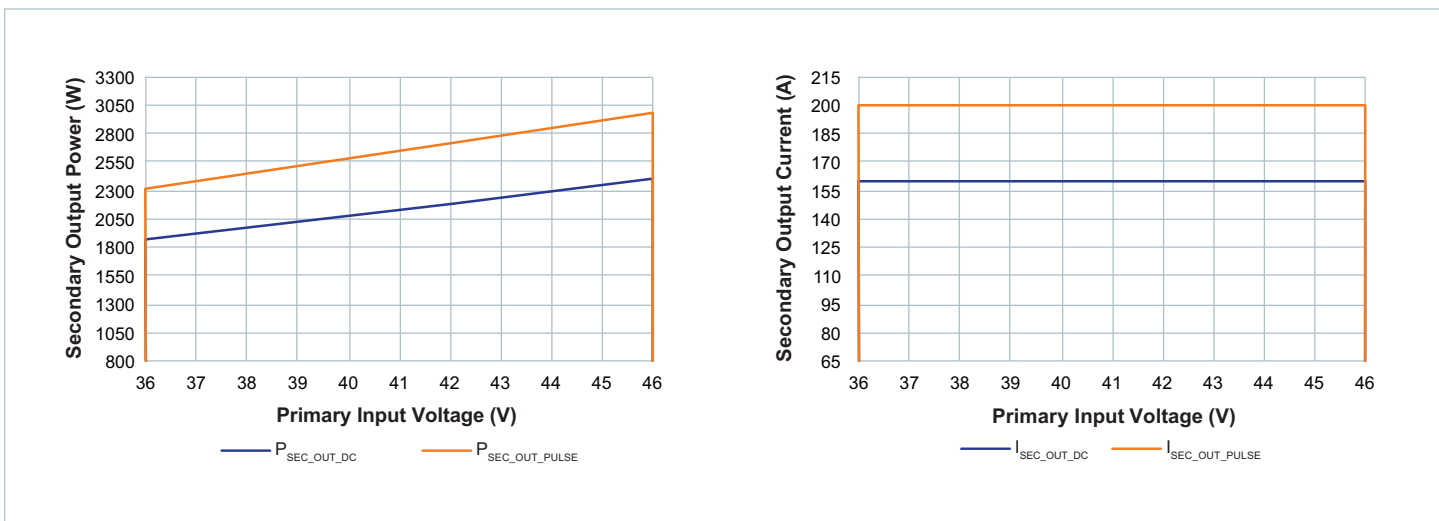

Figure 2 — Specified electrical operating area using rated R_{SEC_HOT}

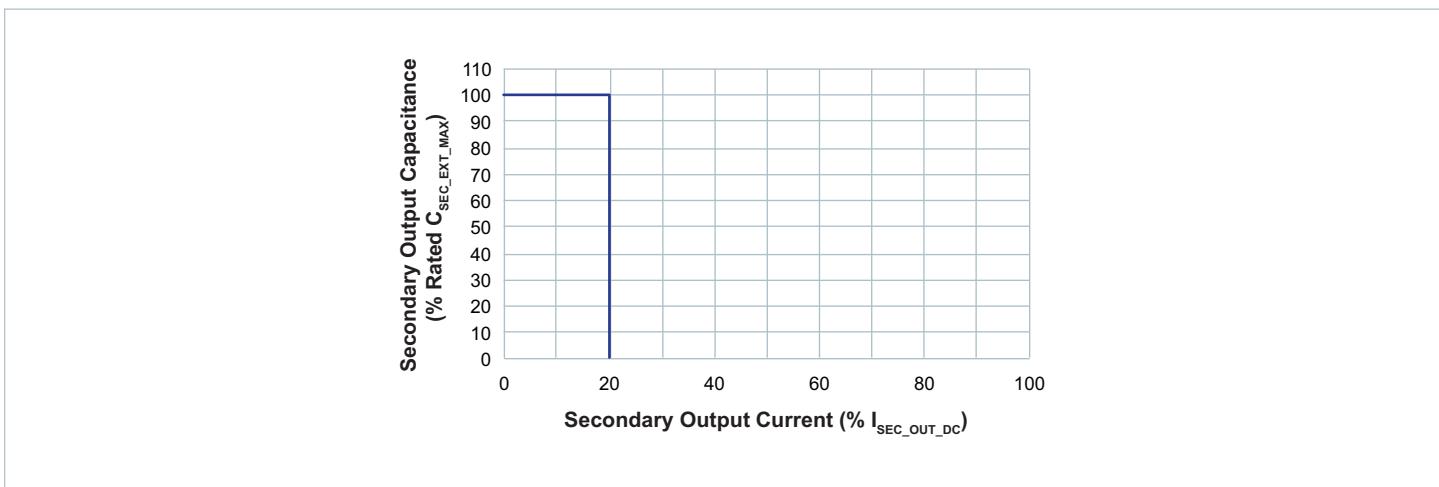

Figure 3 — Specified Primary start-up into load current and external capacitance

Signal Characteristics

Specifications apply over all line, load conditions, unless otherwise noted; **Boldface** specifications apply over the temperature range of $-40^{\circ}\text{C} \leq T_{\text{INTERNAL}} \leq 125^{\circ}\text{C}$ (T-Grade); All other specifications are at $T_{\text{INTERNAL}} = 25^{\circ}\text{C}$ unless otherwise noted.

Temperature Monitor									
<ul style="list-style-type: none"> The TM pin is a standard analog I/O configured as an output from an internal μC. The TM pin monitors the internal temperature of the controller IC within an accuracy of $\pm 5^{\circ}\text{C}$. μC 250 kHz PWM output internally pulled high to 3.3 V. 									
SIGNAL TYPE	STATE	ATTRIBUTE	SYMBOL	CONDITIONS / NOTES	MIN	TYP	MAX	UNIT	
DIGITAL OUTPUT	Startup	Powertrain active to TM time	t_{TM}			100		μs	
		TM Duty Cycle	TM_{PWM}		18.18		68.18	%	
	Regular Operation	TM Current	I_{TM}					4	mA
		Recommended External filtering							
		TM Capacitance (External)	$C_{\text{TM_EXT}}$	Recommended External filtering			0.01		μF
		TM Resistance (External)	$R_{\text{TM_EXT}}$	Recommended External filtering			1		$\text{k}\Omega$
		Specifications using recommended filter							
		TM Gain	A_{TM}				10		$\text{mV} / ^{\circ}\text{C}$
		TM Voltage Reference	$V_{\text{TM_AMB}}$				1.27		V
		TM Voltage Ripple	$V_{\text{TM_PP}}$	$R_{\text{TM_EXT}} = 1 \text{ K Ohm}, C_{\text{TM_EXT}} = 0.01 \text{ uF}, V_{\text{PRI_DC}} = 42 \text{ V}, I_{\text{SEC_DC}} = 160 \text{ A}$ $T_{\text{INTERNAL}} \leq 100^{\circ}\text{C}$			28		mV
						40			

Enable / Disable Control									
<ul style="list-style-type: none"> The EN pin is a standard analog I/O configured as an input to an internal μC. It is internally pulled high to 3.3 V. When held low the NBM™ internal bias will be disabled and the powertrain will be inactive. In an array of NBMs, EN pins should be interconnected to synchronize startup. Unit must not be disabled if a load is present on +VPRI while in reverse operation. 									
SIGNAL TYPE	STATE	ATTRIBUTE	SYMBOL	CONDITIONS / NOTES	MIN	TYP	MAX	UNIT	
ANALOG INPUT	Startup	EN to Powertrain active time	$t_{\text{EN_START}}$	$V_{\text{PRI_DC}} > V_{\text{PRI_UVLO+}}$, EN held low both conditions satisfied for $T > t_{\text{PRI_UVLO+_DELAY}}$		250		μs	
		EN Voltage Threshold	$V_{\text{EN_TH}}$			2.3		V	
	Regular Operation	EN Resistance (Internal)	$R_{\text{EN_INT}}$	Internal pull up resistor			1.5		$\text{k}\Omega$
		EN Disable Threshold	$V_{\text{EN_DISABLE_TH}}$					1	V

Signal Characteristics (Cont.)

Specifications apply over all line, load conditions, unless otherwise noted; **Boldface** specifications apply over the temperature range of $-40^{\circ}\text{C} \leq T_{\text{INTERNAL}} \leq 125^{\circ}\text{C}$ (T-Grade); All other specifications are at $T_{\text{INTERNAL}} = 25^{\circ}\text{C}$ unless otherwise noted.

Auxiliary Voltage Source									
<ul style="list-style-type: none"> The VAUX pin is a standard analog I/O configured as an output from an internal μC. VAUX is internally connected to μC output as internally pulled high to a 3.3 V regulator with 2% tolerance, a 1% resistor of 1.5 kΩ. VAUX can be used as a "Ready to process full power" flag. This pin transitions VAUX voltage after a 2 ms delay from the start of powertrain activating, signaling the end of softstart. VAUX can be used as "Fault flag". This pin is pulled low internally when a fault protection is detected. 									
SIGNAL TYPE	STATE	ATTRIBUTE	SYMBOL	CONDITIONS / NOTES	MIN	TYP	MAX	UNIT	
ANALOG OUTPUT	Startup	Powertrain active to VAUX time	t_{VAUX}	Powertrain active to VAUX High		2		ms	
	Regular Operation	VAUX Voltage	V_{VAUX}		2.8		3.3	V	
		VAUX Available Current	I_{VAUX}				4	mA	
		VAUX Voltage Ripple	$V_{\text{VAUX_PP}}$	$T_{\text{INTERNAL}} \leq 100^{\circ}\text{C}$		50		100	mV
		VAUX Capacitance (External)	$C_{\text{VAUX_EXT}}$					0.01	μF
	VAUX Resistance (External)	$R_{\text{VAUX_EXT}}$	$V_{\text{PRI_DC}} < V_{\mu\text{C_ACTIVE}}$		1.5			k Ω	
Fault	VAUX Fault Response Time	$t_{\text{VAUX_FR}}$		From fault to $V_{\text{VAUX}} = 2.8 \text{ V}$, $C_{\text{VAUX}} = 0 \text{ pF}$		10		μs	

Signal Ground								
<ul style="list-style-type: none"> Signal ground is internally connect to PGND through a zero ohm resistor. Internal SGND traces are not designed to support high current. 								

NBM™ Forward Direction Timing Diagram

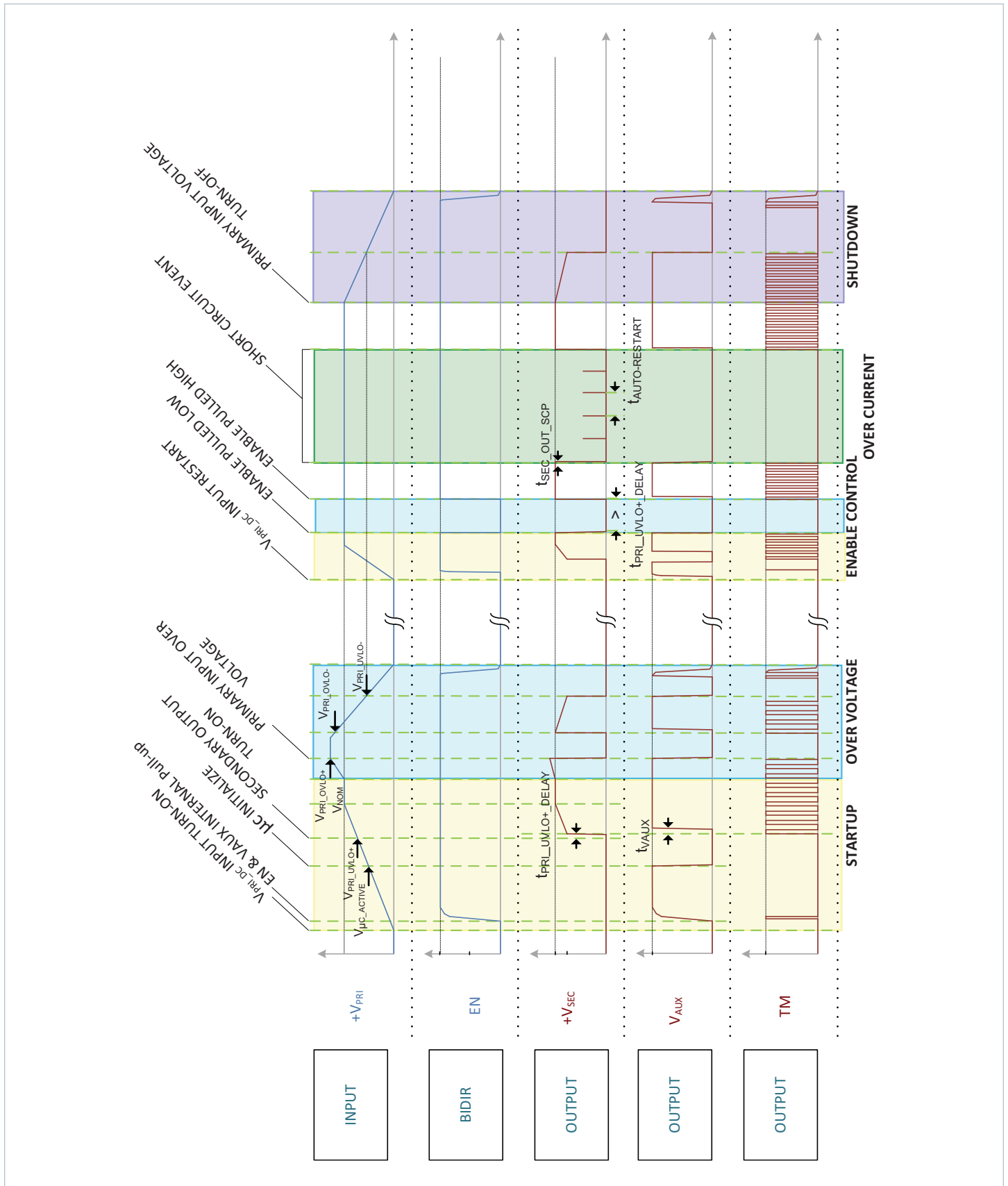

NBM™ Reverse Direction Timing Diagram

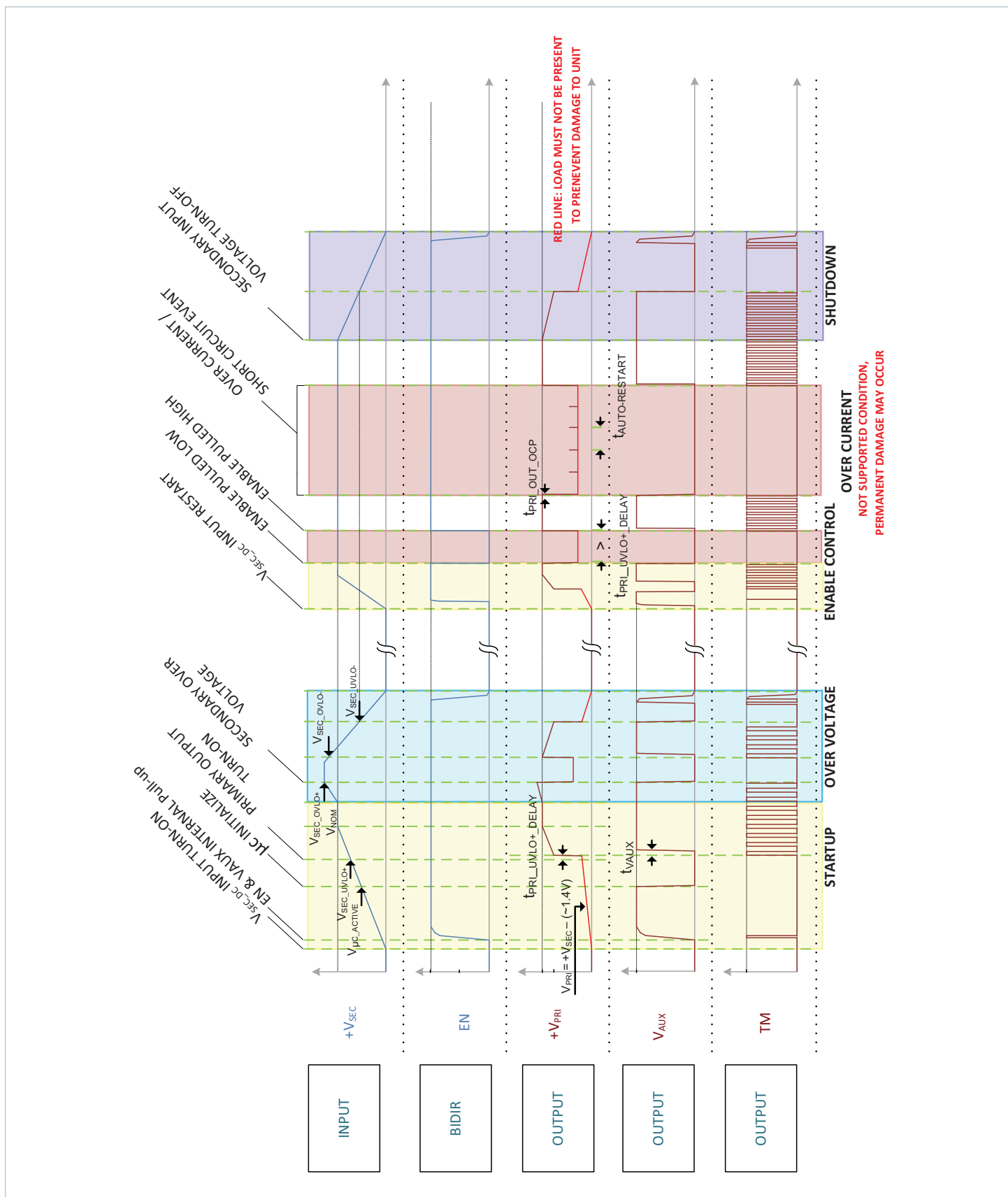

High Level Functional State Diagram

Conditions that cause state transitions are shown along arrows. Sub-sequence activities listed inside the state bubbles.

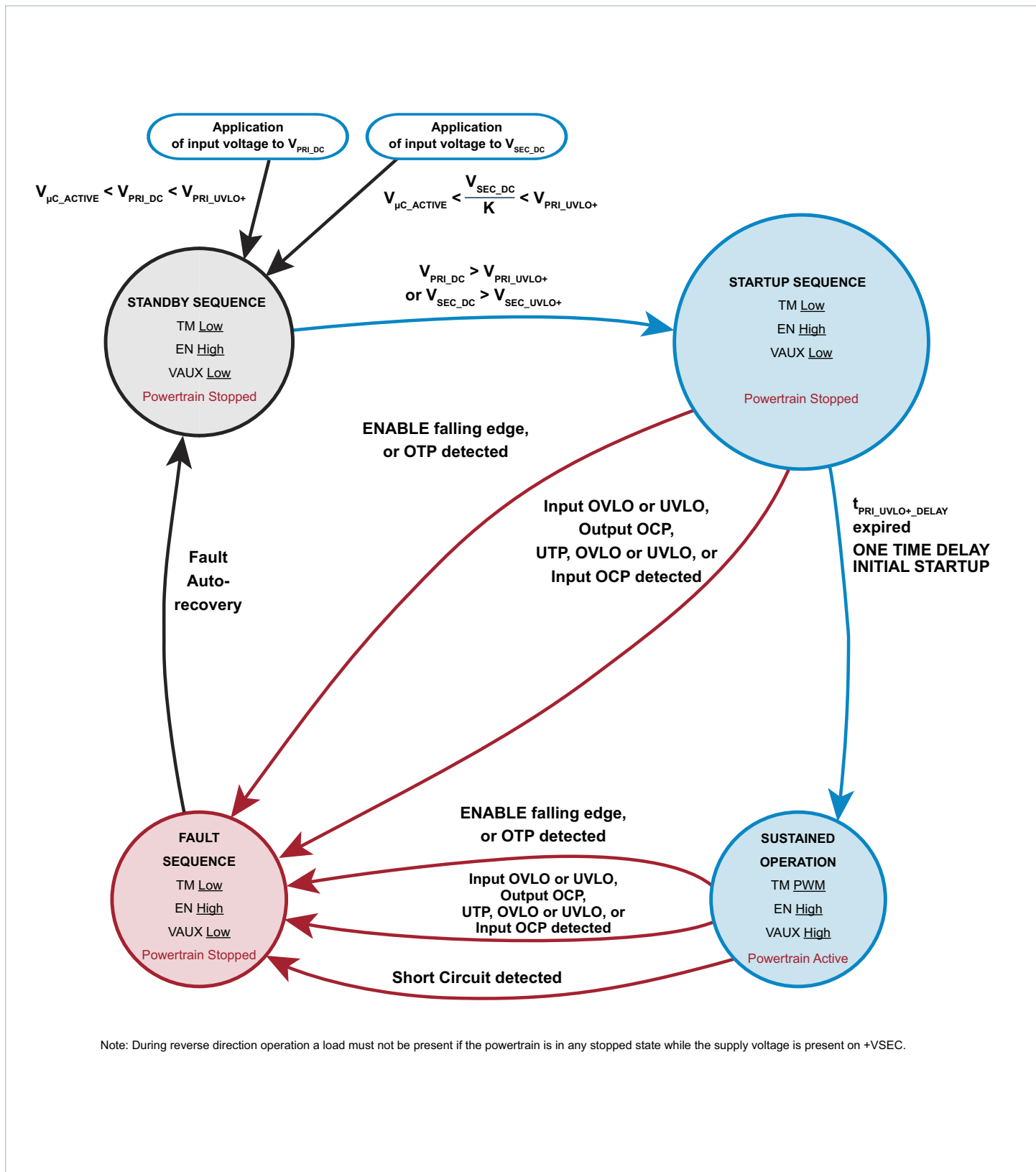

Application Characteristics

Product is mounted and temperature controlled via top side cold plate, unless otherwise noted. All data presented in this section are collected data from primary sourced units processing power in forward direction. See associated figures for general trend data.

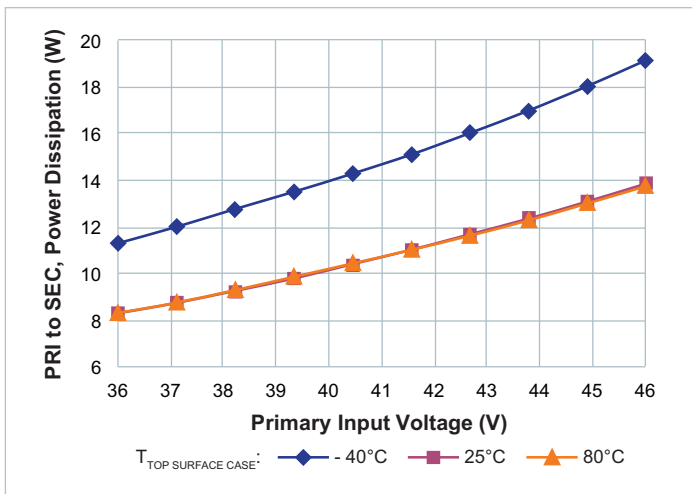

Figure 4 — No load power dissipation vs. V_{PRI_DC}

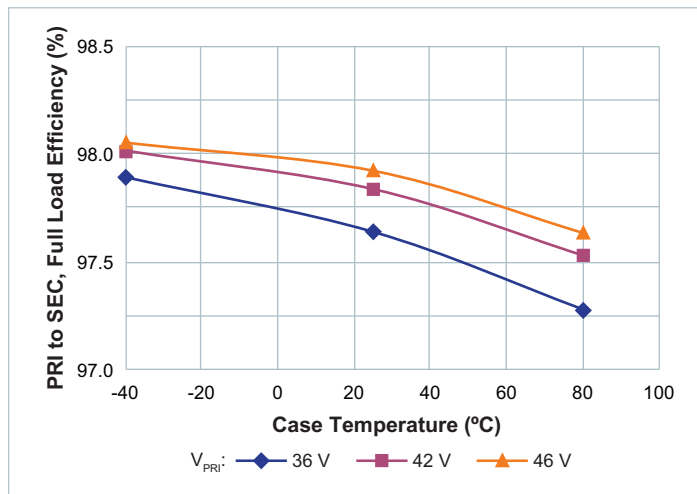

Figure 5 — Full load efficiency vs. temperature; V_{PRI_DC}

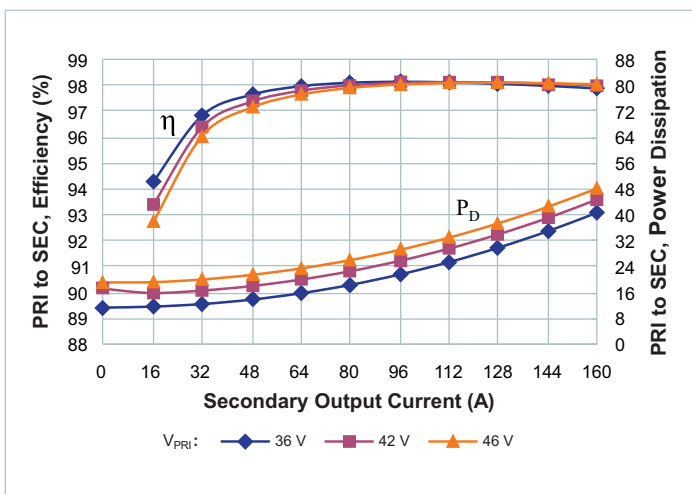

Figure 6 — Efficiency and power dissipation at $T_{CASE} = -40^{\circ}C$

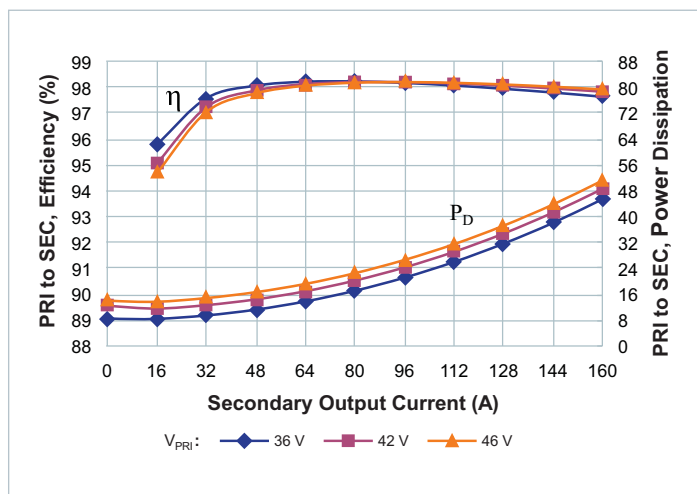

Figure 7 — Efficiency and power dissipation at $T_{CASE} = 25^{\circ}C$

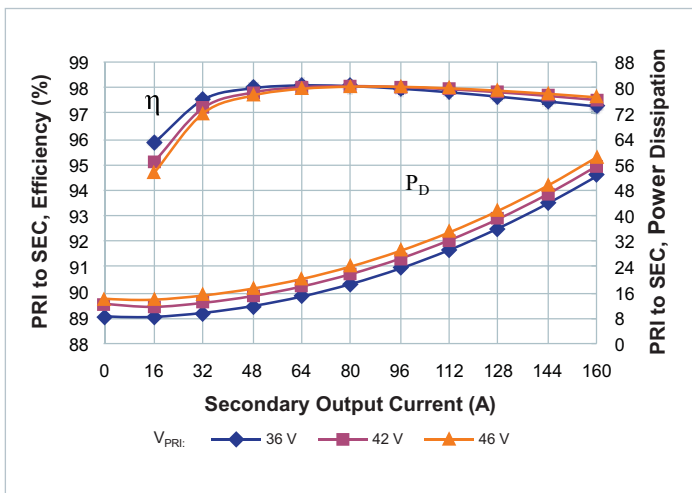

Figure 8 — Efficiency and power dissipation at $T_{CASE} = 80^{\circ}C$

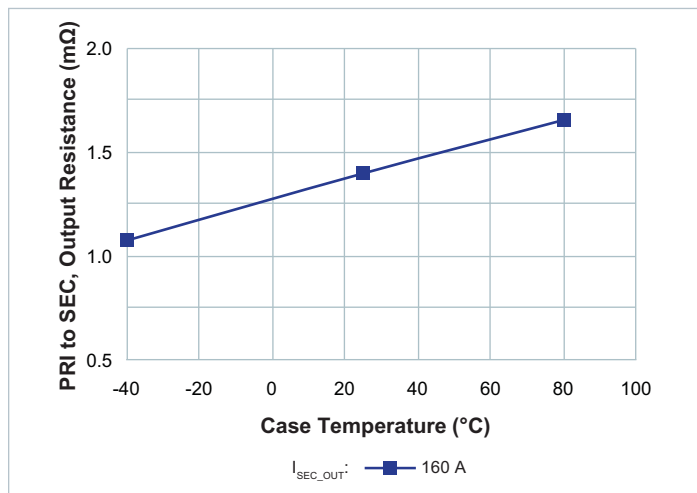

Figure 9 — R_{OUT} vs. temperature; Nominal V_{PRI_DC}
 $I_{SEC_DC} = 160 A$ at $T_{CASE} = 80^{\circ}C$

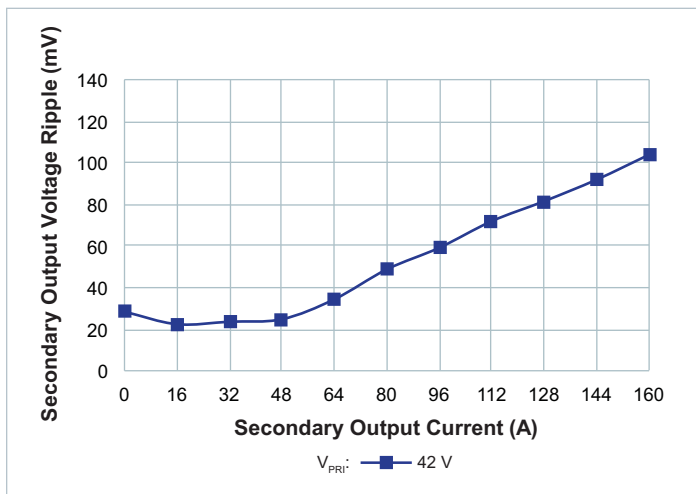

Figure 10 — $V_{SEC_OUT_PP}$ vs. I_{SEC_DC} ; No external $C_{SEC_OUT_EXT}$. Board mounted module, scope setting : 20 MHz analog BW

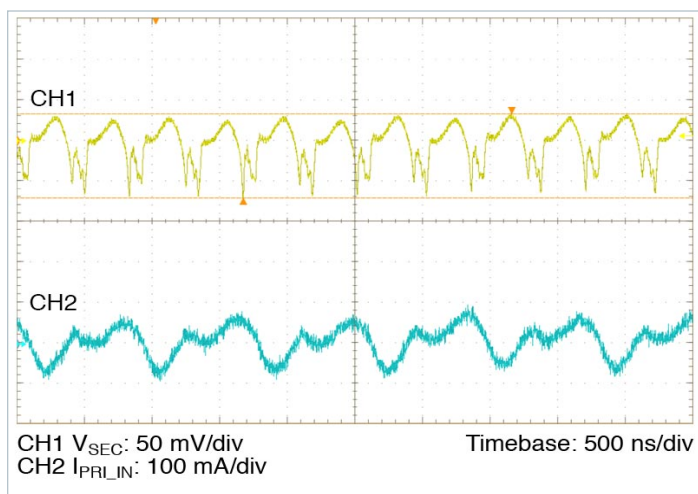

Figure 11 — Full load ripple, 270 μ F $C_{PRI_OUT_EXT}$; No external $C_{SEC_OUT_EXT}$. Board mounted module, scope setting : 20 MHz analog BW

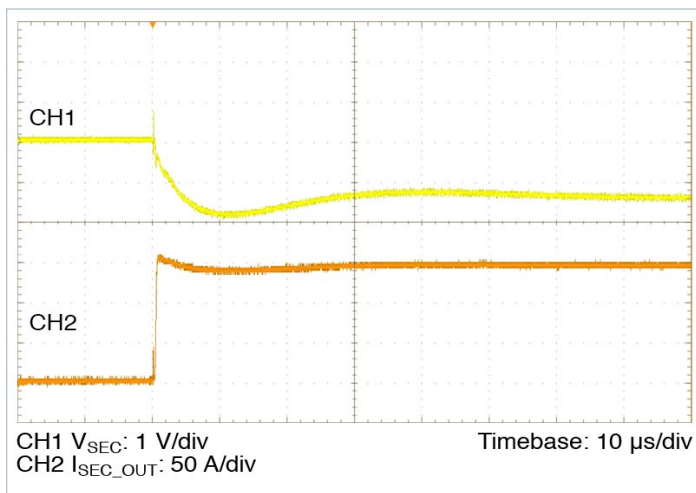

Figure 12 — 0 A– 160 A transient response: $C_{PRI_OUT_EXT} = 270 \mu$ F, no external $C_{SEC_OUT_EXT}$

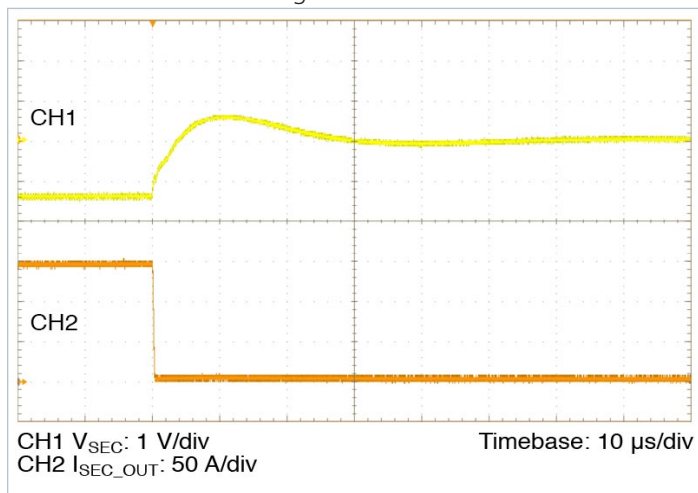

Figure 13 — 160 A – 0 A transient response: $C_{IN} = 270 \mu$ F, no external $C_{SEC_OUT_EXT}$

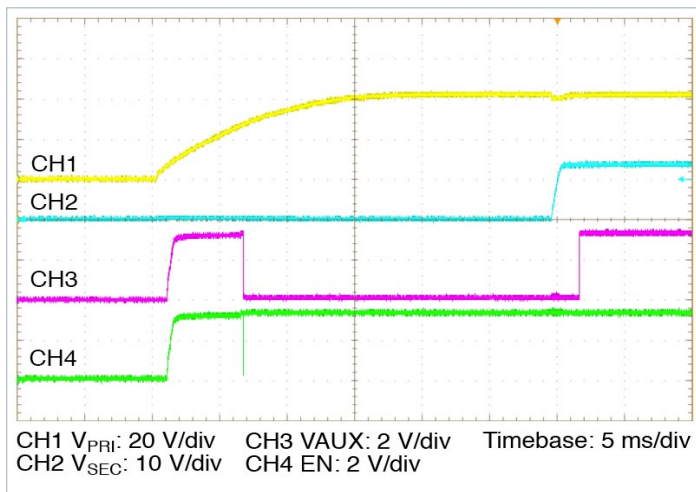

Figure 14 — Start up from application of $V_{PRI_DC} = 42$ V, 20% I_{OUT} , 100% $C_{SEC_OUT_EXT}$

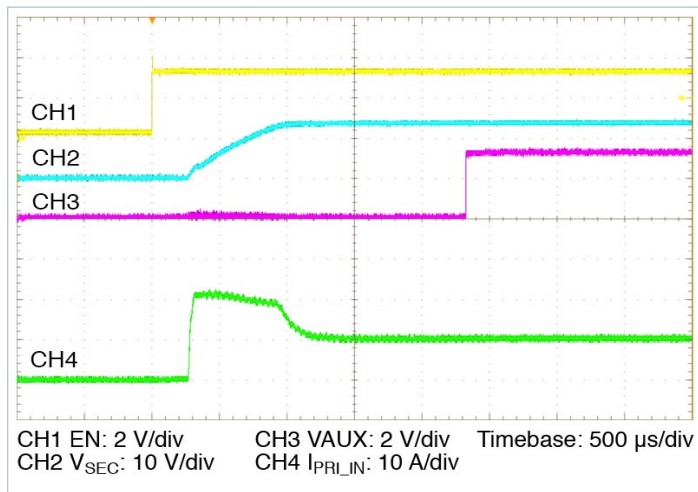

Figure 15 — Start up from application of EN with pre-applied $V_{PRI_DC} = 42$ V, 20% I_{SEC_DG} , 100% $C_{SEC_OUT_EXT}$

General Characteristics

Specifications apply over all line, load conditions, unless otherwise noted; **Boldface** specifications apply over the temperature range of $-40^{\circ}\text{C} \leq T_{\text{INTERNAL}} \leq 125^{\circ}\text{C}$ (T-Grade); All other specifications are at $T_{\text{INTERNAL}} = 25^{\circ}\text{C}$ unless otherwise noted.

Attribute	Symbol	Conditions / Notes	Min	Typ	Max	Unit
Mechanical						
Length	L		60.87 / [2.396]	61.00 / [2.402]	61.13 / [2.407]	mm/[in]
Width	W		24.76 / [0.975]	25.14 / [0.990]	25.52 / [1.005]	mm/[in]
Height	H		7.21 / [0.284]	7.26 / [0.286]	7.31 / [0.288]	mm/[in]
Volume	Vol	Without Heatsink		11.13 / [0.679]		cm ³ /[in ³]
Weight	W			41 / [1.45]		g/[oz]
Lead finish		Nickel	0.51		2.03	μm
		Palladium	0.02		0.15	
		Gold	0.003		0.051	
Thermal						
Operating Temperature	T_{INTERNAL}	NBM6123T46C15A6T0R (T-Grade)	-40		125	°C
Thermal Resistance Top Side	$\Phi_{\text{INT-TOP}}$	Estimated thermal resistance to maximum temperature internal component from isothermal top		1.36		°C/W
Thermal Resistance Leads	$\Phi_{\text{INT-LEADS}}$	Estimated thermal resistance to maximum temperature internal component from isothermal leads		1.36		°C/W
Thermal Resistance Bottom Side	$\Phi_{\text{INT-BOTTOM}}$	Estimated thermal resistance to maximum temperature internal component from isothermal bottom		1.24		°C/W
Thermal Capacity				34		Ws/°C
Assembly						
Storage temperature		NBM6123T46C15A6T0R (T-Grade)	-40		125	°C
ESD Withstand	ESD _{HBM}	Human Body Model, "ESDA / JEDEC JDS-001-2012" Class I-C (1kV to < 2 kV)				
	ESD _{CDM}	Charge Device Model, "JESD 22-C101-E" Class II (200V to < 500V)				

General Characteristics

Specifications apply over all line, load conditions, unless otherwise noted; **Boldface** specifications apply over the temperature range of $-40^{\circ}\text{C} \leq T_{\text{INTERNAL}} \leq 125^{\circ}\text{C}$ (T-Grade); All other specifications are at $T_{\text{INTERNAL}} = 25^{\circ}\text{C}$ unless otherwise noted.

Soldering ^[1]						
Peak Temperature Top Case					135	°C
Safety						
Isolation voltage / Dielectric test	V _{HIPOT}	PRIMARY to SECONDARY	N/A			V
		PRIMARY to CASE	2250			
		SECONDARY to CASE	2250			
Isolation Capacitance	C _{PRI_SEC}	Unpowered Unit	N/A	N/A	N/A	pF
Insulation Resistance	R _{PRI_SEC}	At 500 Vdc	0			MΩ
MTBF		MIL-HDBK-217Plus Parts Count - 25°C Ground Benign, Stationary, Indoors / Computer		3.34		MHrs
		Telcordia Issue 2 - Method I Case III; 25°C Ground Benign, Controlled		5.26		MHrs
Agency Approvals / Standards		cTUVus; EN 60950-1				
		cURus; UL 60950-1				
		CE Marked for Low Voltage Directive and RoHS Recast Directive, as applicable				

^[1] Product is not intended for reflow solder attach.

NBM™ Module Block Diagram

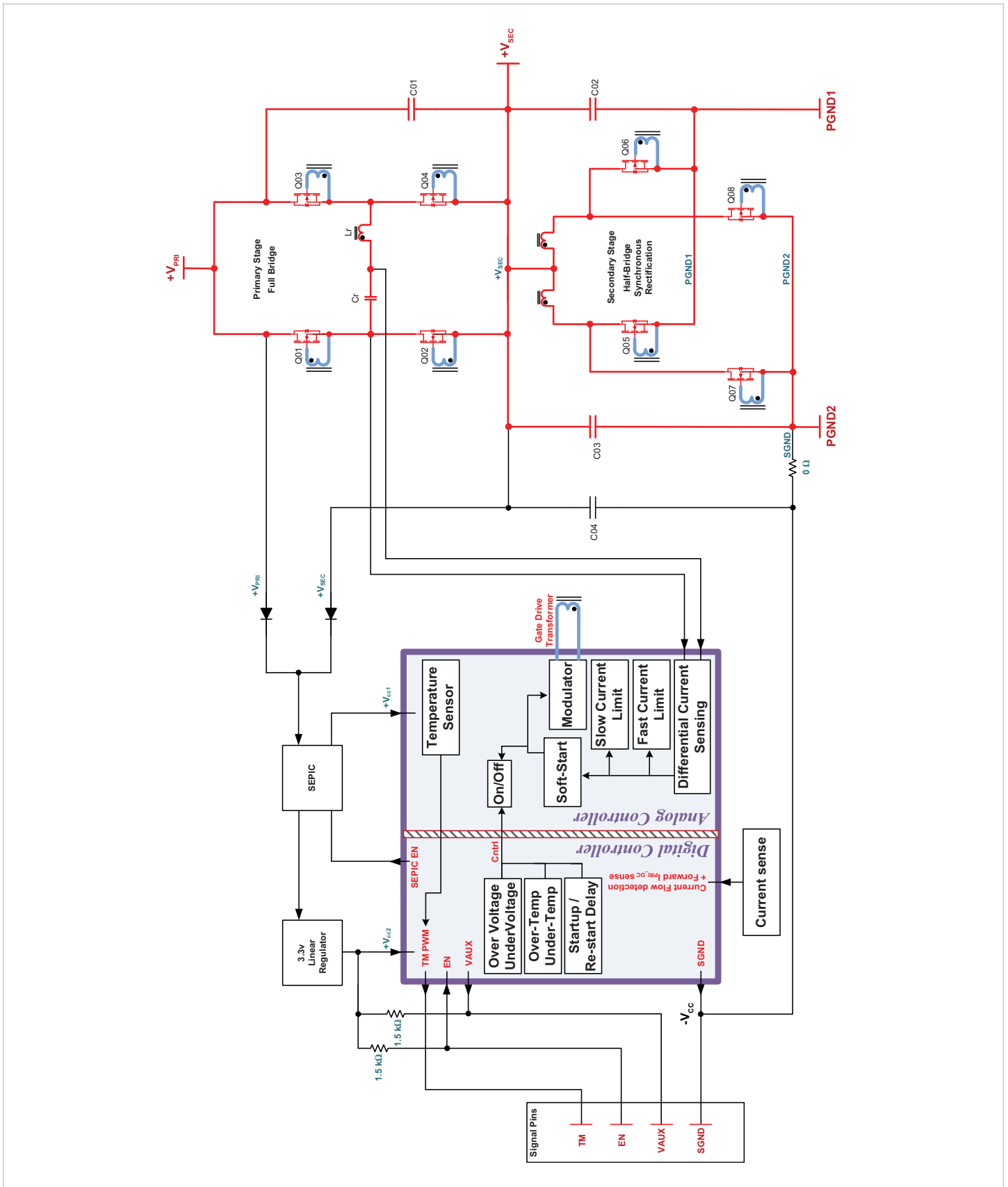

Sine Amplitude Converter™ Point of Load Conversion

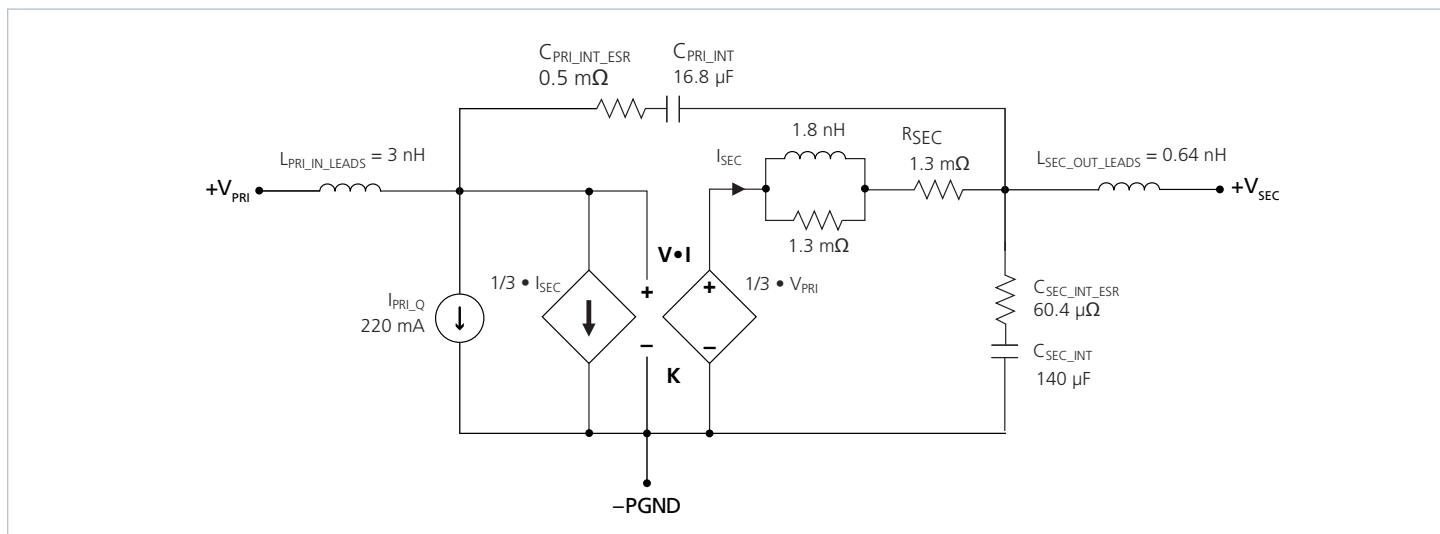

Figure 16 — NBM module AC model

The Sine Amplitude Converter (SAC™) uses a high frequency resonant tank to move energy from Primary to secondary and vice versa. (The resonant tank is formed by Cr and leakage inductance Lr in the power transformer windings as shown in the NBM™ module Block Diagram). The resonant LC tank, operated at high frequency, is amplitude modulated as a function of input voltage and output current. A small amount of capacitance embedded in the primary and secondary stages of the module is sufficient for full functionality and is key to achieving high power density.

The NBM6123x46C15A6yzz SAC can be simplified into the preceding model.

At no load:

$$V_{SEC} = V_{PRI} \cdot K \tag{1}$$

K represents the “turns ratio” of the SAC.

Rearranging Eq (1):

$$K = \frac{V_{SEC}}{V_{PRI}} \tag{2}$$

In the presence of load, V_OUT is represented by:

$$V_{SEC} = V_{PRI} \cdot K - I_{SEC} \cdot R_{SEC} \tag{3}$$

and I_OUT is represented by:

$$I_{SEC} = \frac{I_{PRI} - I_{PRI_Q}}{K} \tag{4}$$

R_OUT represents the impedance of the SAC, and is a function of the R_DSON of the input and output MOSFETs and the winding resistance of the power transformer. I_Q represents the quiescent current of the SAC control, gate drive circuitry, and core losses.

The use of DC voltage transformation provides additional interesting attributes. Assuming that R_SEC = 0 Ω and I_PRI_Q = 0 A, Eq. (3) now becomes Eq. (1) and is essentially load independent, resistor R is now placed in series with V_IN.

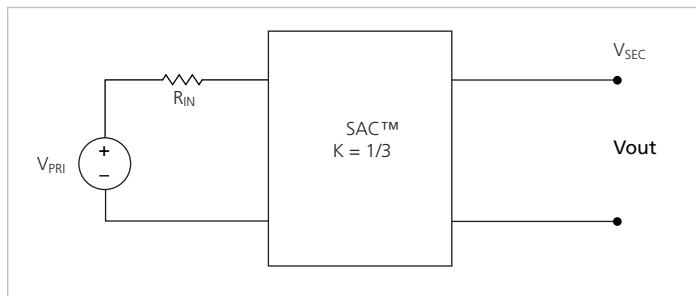

Figure 17 — K = 1/3 Sine Amplitude Converter with series input resistor

The relationship between V_PRI and V_SEC becomes:

$$V_{SEC} = (V_{PRI} - I_{PRI} \cdot R_{IN}) \cdot K \tag{5}$$

Substituting the simplified version of Eq. (4)

(I_PRI_Q is assumed = 0 A) into Eq. (5) yields:

$$V_{SEC} = V_{PRI} \cdot K - I_{SEC} \cdot R_{IN} \cdot K^2 \tag{6}$$

This is similar in form to Eq. (3), where R_{SEC} is used to represent the characteristic impedance of the SAC™. However, in this case a real R on the primary side of the SAC is effectively scaled by K^2 with respect to the secondary.

Assuming that $R = 1 \Omega$, the effective R as seen from the secondary side is 111 mΩ, with $K = 1/3$.

A similar exercise should be performed with the addition of a capacitor or shunt impedance at the primary input to the SAC. A switch in series with V_{PRI} is added to the circuit. This is depicted in Figure 18.

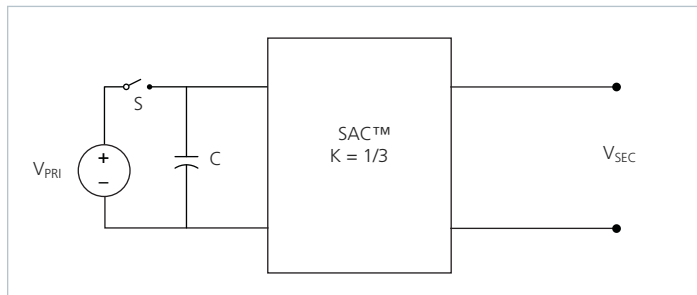

Figure 18 — Sine Amplitude Converter with input capacitor

A change in V_{PRI} with the switch closed would result in a change in capacitor current according to the following equation:

$$I_C(t) = C \frac{dV_{PRI}}{dt} \tag{7}$$

Assume that with the capacitor charged to V_{PRI} , the switch is opened and the capacitor is discharged through the idealized SAC. In this case,

$$I_C = I_{SEC} \cdot K \tag{8}$$

substituting Eq. (1) and (8) into Eq. (7) reveals:

$$I_{SEC} = \frac{C}{K^2} \cdot \frac{dI_{SEC}}{dt} \tag{9}$$

The equation in terms of the output has yielded a K^2 scaling factor for C, specified in the denominator of the equation.

A K factor less than unity results in an effectively larger capacitance on the secondary output when expressed in terms of the input. With a $K = 1/3$ as shown in Figure 18, $C = 1 \mu F$ would appear as $C = 9 \mu F$ when viewed from the secondary.

Low impedance is a key requirement for powering a high-current, low-voltage load efficiently. A switching regulation stage should have minimal impedance while simultaneously providing appropriate filtering for any switched current. The use of a SAC between the regulation stage and the point of load provides a dual benefit of scaling down series impedance leading back to the source and scaling up shunt capacitance or energy storage as a function of its K factor squared. However, the benefits are not useful if the series impedance of the SAC is too high. The impedance of the SAC must be low, i.e. well beyond the crossover frequency of the system.

A solution for keeping the impedance of the SAC low involves switching at a high frequency. This enables small magnetic components because magnetizing currents remain low. Small magnetics mean small path lengths for turns. Use of low loss core material at high frequencies also reduces core losses.

The two main terms of power loss in the NBM™ module are:

- No load power dissipation (P_{PRI_NL}): defined as the power used to power up the module with an enabled powertrain at no load.
- Resistive loss (R_{SEC}): refers to the power loss across the NBM module modeled as pure resistive impedance.

$$P_{DISSIPATED} = P_{PRI_NL} + P_{R_{SEC}} \tag{10}$$

Therefore,

$$P_{SEC_OUT} = P_{PRI_IN} - P_{DISSIPATED} = P_{PRI_IN} - P_{PRI_NL} - P_{R_{SEC}} \tag{11}$$

The above relations can be combined to calculate the overall module efficiency:

$$\begin{aligned} \eta &= \frac{P_{SEC_OUT}}{P_{IN}} = \frac{P_{PRI_IN} - P_{PRI_NL} - P_{R_{SEC}}}{P_{IN}} \tag{12} \\ &= \frac{V_{PRI} \cdot I_{PRI} - P_{PRI_NL} - (I_{SEC})^2 \cdot R_{SEC}}{V_{IN} \cdot I_{IN}} \\ &= 1 - \left(\frac{P_{PRI_NL} + (I_{SEC})^2 \cdot R_{SEC}}{V_{PRI} \cdot I_{PRI}} \right) \end{aligned}$$

Input and Output Filter Design

A major advantage of SAC™ systems versus conventional PWM converters is that the transformer based SAC does not require external filtering to function properly. The resonant LC tank, operated at extreme high frequency, is amplitude modulated as a function of input voltage and output current and efficiently transfers charge through the non-isolated transformer. A small amount of capacitance embedded in the primary and secondary stages of the module is sufficient for full functionality and is key to achieving power density.

This paradigm shift requires system design to carefully evaluate external filters in order to:

- Guarantee low source impedance:

To take full advantage of the NBM™ module’s dynamic response, the impedance presented to its input terminals must be low from DC to approximately 5 MHz. The connection of the bus converter module to its power source should be implemented with minimal distribution inductance. If the interconnect inductance exceeds 100 nH, the input should be bypassed with a RC damper to retain low source impedance and stable operation. With an interconnect inductance of 200 nH, the RC damper may be as high as 1 μF in series with 0.3 Ω. A single electrolytic or equivalent low-Q capacitor may be used in place of the series RC bypass.
- Further reduce input and/or output voltage ripple without sacrificing dynamic response:

Given the wide bandwidth of the module, the source response is generally the limiting factor in the overall system response. Anomalies in the response of the source will appear at the output of the module multiplied by its K factor.
- Protect the module from overvoltage transients imposed by the system that would exceed maximum ratings and induce stresses:

The module primary/secondary voltage ranges shall not be exceeded. An internal overvoltage lockout function prevents operation outside of the normal operating input range. Even when disabled, the powertrain is exposed to the applied voltage and power MOSFETs must withstand it.

Total load capacitance at the output of the NBM module shall not exceed the specified maximum. Owing to the wide bandwidth and low output impedance of the module, low-frequency bypass capacitance and significant energy storage may be more densely and efficiently provided by adding capacitance at the input of the module. At frequencies <500 kHz the module appears as an impedance of R_{SEC} between the source and load.

Within this frequency range, capacitance at the input appears as effective capacitance on the output per the relationship defined in Eq. (13).

$$C_{SEC_EXT} = \frac{C_{PRI_EXT}}{K^2} \quad (13)$$

This enables a reduction in the size and number of capacitors used in a typical system.

Thermal Considerations

The ChiP package provides a high degree of flexibility in that it presents three pathways to remove heat from internal power dissipating components. Heat may be removed from the top surface, the bottom surface and the leads. The extent to which these three surfaces are cooled is a key component for determining the maximum power that is available from a ChiP, as can be seen from Figure 1.

Since the ChiP has a maximum internal temperature rating, it is necessary to estimate this internal temperature based on a real thermal solution. Given that there are three pathways to remove heat from the ChiP, it is helpful to simplify the thermal solution into a roughly equivalent circuit where power dissipation is modeled as a current source, isothermal surface temperatures are represented as voltage sources and the thermal resistances are represented as resistors. Figure 19 shows the “thermal circuit” for a NBM module 6123 in an application where the top, bottom, and leads are cooled. In this case, the NBM power dissipation is PD_{TOTAL} and the three surface temperatures are represented as T_{CASE_TOP}, T_{CASE_BOTTOM}, and T_{LEADS}. This thermal system can now be very easily analyzed using a SPICE simulator with simple resistors, voltage sources, and a current source. The results of the simulation would provide an estimate of heat flow through the various pathways as well as internal temperature.

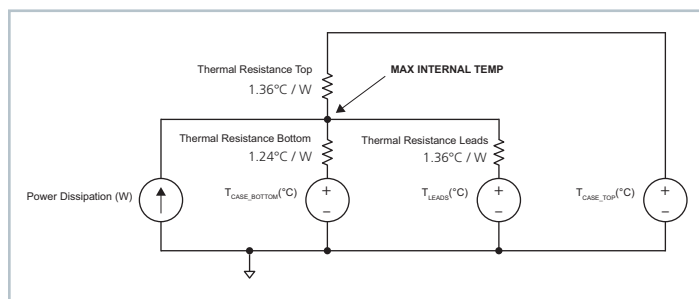

Figure 19 — Top case, Bottom case and leads thermal model

Alternatively, equations can be written around this circuit and analyzed algebraically:

$$T_{INT} - PD_1 \cdot 1.24 = T_{CASE_TOP}$$

$$T_{INT} - PD_2 \cdot 1.24 = T_{CASE_BOTTOM}$$

$$T_{INT} - PD_3 \cdot 7 = T_{LEADS}$$

$$PD_{TOTAL} = PD_1 + PD_2 + PD_3$$

Where T_{INT} represents the internal temperature and PD₁, PD₂, and PD₃ represent the heat flow through the top side, bottom side, and leads respectively.

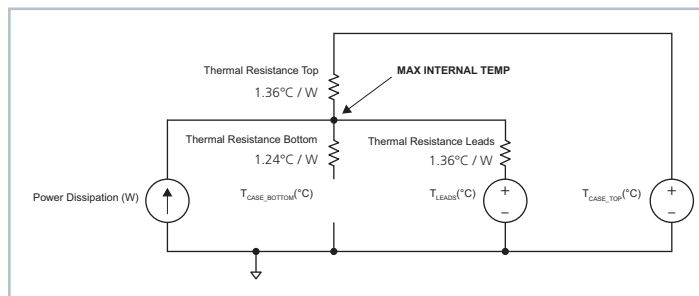

Figure 20 — Top case and leads thermal model

Figure 20 shows a scenario where there is no bottom side cooling. In this case, the heat flow path to the bottom is left open and the equations now simplify to:

$$T_{INT} - PD_1 \cdot 1.24 = T_{CASE_TOP}$$

$$T_{INT} - PD_3 \cdot 7 = T_{LEADS}$$

$$PD_{TOTAL} = PD_1 + PD_3$$

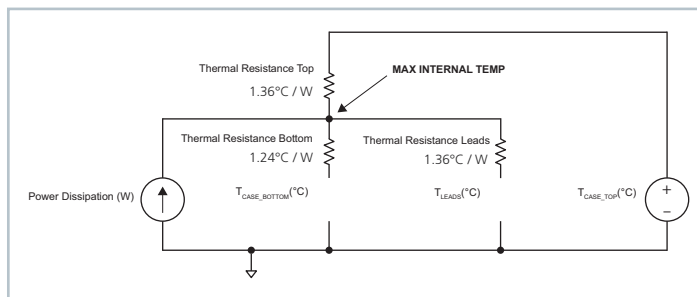

Figure 21 — Top case thermal model

Figure 21 shows a scenario where there is no bottom side and leads cooling. In this case, the heat flow path to the bottom is left open and the equations now simplify to:

$$T_{INT} - PD_1 \cdot 1.24 = T_{CASE_TOP}$$

$$PD_{TOTAL} = PD_1$$

Please note that Vicor has a suite of online tools, including a simulator and thermal estimator which greatly simplify the task of determining whether or not a NBM™ thermal configuration is valid for a given condition. These tools can be found at:

<http://www.vicorpower.com/powerbench>.

Current Sharing

The performance of the SAC™ topology is based on efficient transfer of energy through a transformer without the need of closed loop control. For this reason, the transfer characteristic can be approximated by an ideal transformer with a positive temperature coefficient series resistance.

This type of characteristic is close to the impedance characteristic of a DC power distribution system both in dynamic (AC) behavior and for steady state (DC) operation.

When multiple NBM modules of a given part number are connected in an array they will inherently share the load current according to the equivalent impedance divider that the system implements from the power source to the point of load.

Some general recommendations to achieve matched array impedances include:

- Dedicate common copper planes within the PCB to deliver and return the current to the modules.
- Provide as symmetric a PCB layout as possible among modules
- An input filter is required for an array of NBMs in order to prevent circulating currents.

For further details see [AN:016 Using BCM Bus Converters in High Power Arrays](#).

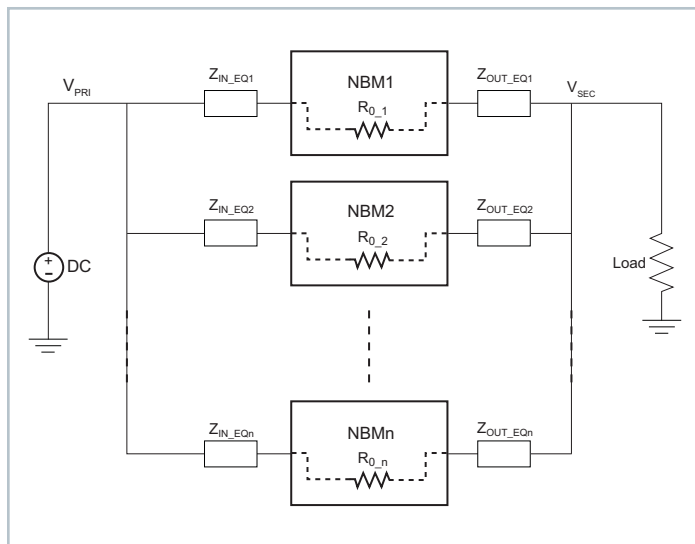

Figure 22 — NBM module array

Fuse Selection

In order to provide flexibility in configuring power systems VI Chip® modules are not internally fused. Input line fusing of VI Chip products is recommended at system level to provide thermal protection in case of catastrophic failure.

The fuse shall be selected by closely matching system requirements with the following characteristics:

- Current rating
(usually greater than maximum current of NBM module)
- Maximum voltage rating
(usually greater than the maximum possible input voltage)
- Ambient temperature
- Nominal melting I²t
- Recommend fuse: ≤ 60 A Littelfuse TLS Series

Startup and Reverse Operation

The NBM6123T46C15A6T0R is capable of startup in forward and reverse direction once the applied voltage is greater than the undervoltage lockout threshold.

The non-isolated bus converter modules are capable of reverse power operation. Once the unit is enabled, energy can be transferred from secondary back to the primary whenever the secondary voltage exceeds $V_{PRI} \cdot K$. The module will continue operation in this fashion for as long as no faults occur.

Startup loading could be set to no greater than 20% of rated max current respectively in forward or reverse direction. A load must not be present on the +V_{PRI} pin if the powertrain is not actively switching. Remove +V_{PRI} load prior to disabling the module using EN pin. Primary MOSEFT body diode conduction will occur if unit stops switching while a load is present on the +V_{PRI} and +V_{SEC} voltage is two diodes drop higher than +V_{PRI}.

NBM™ Module Through Hole Package Mechanical Drawing and Recommended Land Pattern

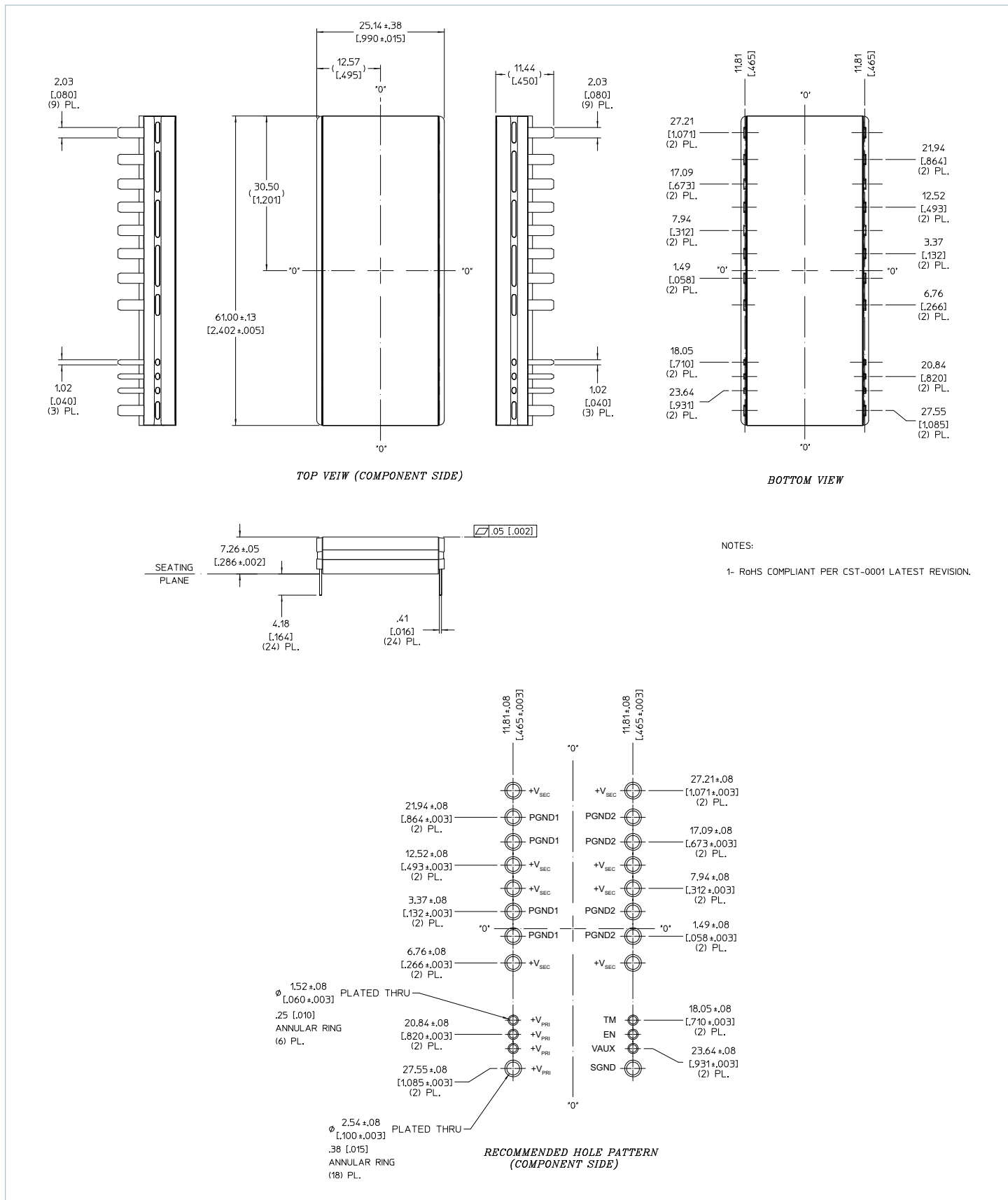

Revision History

Revision	Date	Description	Page Number(s)
1.0	09/08/15	Initial Release	n/a
1.1	09/28/15	Changed PRI to SEC Input Quiescent Current	5

Vicor's comprehensive line of power solutions includes high density AC-DC and DC-DC modules and accessory components, fully configurable AC-DC and DC-DC power supplies, and complete custom power systems.

Information furnished by Vicor is believed to be accurate and reliable. However, no responsibility is assumed by Vicor for its use. Vicor makes no representations or warranties with respect to the accuracy or completeness of the contents of this publication. Vicor reserves the right to make changes to any products, specifications, and product descriptions at any time without notice. Information published by Vicor has been checked and is believed to be accurate at the time it was printed; however, Vicor assumes no responsibility for inaccuracies. Testing and other quality controls are used to the extent Vicor deems necessary to support Vicor's product warranty. Except where mandated by government requirements, testing of all parameters of each product is not necessarily performed.

Specifications are subject to change without notice.

Vicor's Standard Terms and Conditions

All sales are subject to Vicor's Standard Terms and Conditions of Sale, which are available on Vicor's webpage or upon request.

Product Warranty

In Vicor's standard terms and conditions of sale, Vicor warrants that its products are free from non-conformity to its Standard Specifications (the "Express Limited Warranty"). This warranty is extended only to the original Buyer for the period expiring two (2) years after the date of shipment and is not transferable.

UNLESS OTHERWISE EXPRESSLY STATED IN A WRITTEN SALES AGREEMENT SIGNED BY A DULY AUTHORIZED VICOR SIGNATORY, VICOR DISCLAIMS ALL REPRESENTATIONS, LIABILITIES, AND WARRANTIES OF ANY KIND (WHETHER ARISING BY IMPLICATION OR BY OPERATION OF LAW) WITH RESPECT TO THE PRODUCTS, INCLUDING, WITHOUT LIMITATION, ANY WARRANTIES OR REPRESENTATIONS AS TO MERCHANTABILITY, FITNESS FOR PARTICULAR PURPOSE, INFRINGEMENT OF ANY PATENT, COPYRIGHT, OR OTHER INTELLECTUAL PROPERTY RIGHT, OR ANY OTHER MATTER.

This warranty does not extend to products subjected to misuse, accident, or improper application, maintenance, or storage. Vicor shall not be liable for collateral or consequential damage. Vicor disclaims any and all liability arising out of the application or use of any product or circuit and assumes no liability for applications assistance or buyer product design. Buyers are responsible for their products and applications using Vicor products and components. Prior to using or distributing any products that include Vicor components, buyers should provide adequate design, testing and operating safeguards.

Vicor will repair or replace defective products in accordance with its own best judgment. For service under this warranty, the buyer must contact Vicor to obtain a Return Material Authorization (RMA) number and shipping instructions. Products returned without prior authorization will be returned to the buyer. The buyer will pay all charges incurred in returning the product to the factory. Vicor will pay all reshipment charges if the product was defective within the terms of this warranty.

Life Support Policy

VICOR'S PRODUCTS ARE NOT AUTHORIZED FOR USE AS CRITICAL COMPONENTS IN LIFE SUPPORT DEVICES OR SYSTEMS WITHOUT THE EXPRESS PRIOR WRITTEN APPROVAL OF THE CHIEF EXECUTIVE OFFICER AND GENERAL COUNSEL OF VICOR CORPORATION. As used herein, life support devices or systems are devices which (a) are intended for surgical implant into the body, or (b) support or sustain life and whose failure to perform when properly used in accordance with instructions for use provided in the labeling can be reasonably expected to result in a significant injury to the user. A critical component is any component in a life support device or system whose failure to perform can be reasonably expected to cause the failure of the life support device or system or to affect its safety or effectiveness. Per Vicor Terms and Conditions of Sale, the user of Vicor products and components in life support applications assumes all risks of such use and indemnifies Vicor against all liability and damages.

Intellectual Property Notice

Vicor and its subsidiaries own Intellectual Property (including issued U.S. and pending patent applications) relating to the products described in this data sheet. No license, whether express, implied, or arising by estoppel or otherwise, to any intellectual property rights is granted by this document. Interested parties should contact Vicor's Intellectual Property Department.

The products described on this data sheet are protected by the following U.S. Patents Numbers: 6,911,848; 6,930,893; 6,934,166; 7,145,786; 7,782,639; 8,427,269 and for use under 6,975,098 and 6,984,965.

Vicor Corporation

25 Frontage Road
Andover, MA, USA 01810
Tel: 800-735-6200
Fax: 978-475-6715

email

Customer Service: custserv@vicorpower.com
Technical Support: apps@vicorpower.com

Mouser Electronics

Authorized Distributor

Click to View Pricing, Inventory, Delivery & Lifecycle Information:

Vicor:

[NBM6123T46C15A6T0R](#)

Компания «Океан Электроники» предлагает заключение долгосрочных отношений при поставках импортных электронных компонентов на взаимовыгодных условиях!

Наши преимущества:

- Поставка оригинальных импортных электронных компонентов напрямую с производств Америки, Европы и Азии, а так же с крупнейших складов мира;
- Широкая линейка поставок активных и пассивных импортных электронных компонентов (более 30 млн. наименований);
- Поставка сложных, дефицитных, либо снятых с производства позиций;
- Оперативные сроки поставки под заказ (от 5 рабочих дней);
- Экспресс доставка в любую точку России;
- Помощь Конструкторского Отдела и консультации квалифицированных инженеров;
- Техническая поддержка проекта, помощь в подборе аналогов, поставка прототипов;
- Поставка электронных компонентов под контролем ВП;
- Система менеджмента качества сертифицирована по Международному стандарту ISO 9001;
- При необходимости вся продукция военного и аэрокосмического назначения проходит испытания и сертификацию в лаборатории (по согласованию с заказчиком);
- Поставка специализированных компонентов военного и аэрокосмического уровня качества (Xilinx, Altera, Analog Devices, Intersil, Interpoint, Microsemi, Actel, Aeroflex, Peregrine, VPT, Syfer, Eurofarad, Texas Instruments, MS Kennedy, Miteq, Cobham, E2V, MA-COM, Hittite, Mini-Circuits, General Dynamics и др.);

Компания «Океан Электроники» является официальным дистрибьютором и эксклюзивным представителем в России одного из крупнейших производителей разъемов военного и аэрокосмического назначения «JONHON», а так же официальным дистрибьютором и эксклюзивным представителем в России производителя высокотехнологичных и надежных решений для передачи СВЧ сигналов «FORSTAR».



JONHON

«JONHON» (основан в 1970 г.)

Разъемы специального, военного и аэрокосмического назначения:

(Применяются в военной, авиационной, аэрокосмической, морской, железнодорожной, горно- и нефтедобывающей отраслях промышленности)

«FORSTAR» (основан в 1998 г.)

ВЧ соединители, коаксиальные кабели,
кабельные сборки и микроволновые компоненты:

(Применяются в телекоммуникациях гражданского и специального назначения, в средствах связи, РЛС, а так же военной, авиационной и аэрокосмической отраслях промышленности).



Телефон: 8 (812) 309-75-97 (многоканальный)

Факс: 8 (812) 320-03-32

Электронная почта: ocean@oceanchips.ru

Web: <http://oceanchips.ru/>

Адрес: 198099, г. Санкт-Петербург, ул. Калинина, д. 2, корп. 4, лит. А