

# Honeywell Sensing and Control AML/MML Selection Guide

# Honeywell Sensing and Control AML/MML Selection Guide

## AML11 Solid state pushbutton switches

### AML11 INCANDESCENT OR NON-LIGHTED DISPLAY ORDER GUIDE

<b>AML11B</b>		<b>B</b>	<b>A</b>	<b>2</b>	<b>EA</b>		
<b>Housing Type</b>		<b>Bezel Color</b>	<b>Incandescent Lamp Type</b>	<b>Terminal Type</b>	<b>Circuitry Codes</b>		
<b>Standard Bezel</b> <b>AML11B</b> Square non-lighted <b>AML11C</b> Square 1 lamp ckt. <b>AML11E</b> Rect. non-lighted <b>AML11F</b> Rect. 1 lamp ckt. <b>AML11G</b> Rect. 2 lamp ckts.  <b>Full Guard Bezel</b> <b>AML11H</b> Square non-lighted <b>AML11J</b> Square 1 lamp ckt. <b>AML11K</b> Rect. non-lighted <b>AML11L</b> Rect. 1 lamp ckt. <b>AML11M</b> Rect. 2 lamp ckts.		<b>B</b> Black	<b>A</b> No lamp installed  <b>E</b> 28 V lamp	<b>2</b> .110 x .020 (solder or quick-connect)  <b>3</b> .025 x .025 (printed, circuit or push-on)	4.5-24 VDC Sinking	<b>EA</b> Momentary	<b>EE</b> Alternate

Discount **BE**  
 Schedule Qty.: 25 pieces/listing  
 Unclass.

Example: **AML11BBA2EA**  
 Square, pushbutton switch housing, non-lighted; black bezel; .110 x .020 termination; momentary action; current-sinking output for use with 5-volt supply.

## AML12 Solid state pushbutton switches

### AML12 LED DISPLAY ORDER GUIDE

<b>AML12C</b>		<b>B</b>	<b>B</b>	<b>2</b>	<b>EA</b>		
<b>Housing Type</b>		<b>Bezel Color</b>	<b>LED Color/ Voltage</b>	<b>Terminal Type/ Diode Protection</b>	<b>Circuitry Codes</b>		
<b>Standard Bezel</b> <b>AML12C</b> Square 1 LED  <b>Full Guard Bezel</b> <b>AML12J</b> Square 1 LED		<b>B</b> Black	<b>Red</b> <b>B</b> 5V <b>C</b> 5V  <b>Yellow</b> <b>J</b> 5V <b>M</b> 24V  <b>Green</b> <b>S</b> 5V <b>X</b> 24V	<b>2</b> .110 x .020 (solder or quick-connect)  <b>3</b> .025 x .025 (printed, circuit or push-on)  <b>8</b> .110 x .020 with diode protection	4.5 - 24 VDC Sinking	<b>EA</b> Momentary	<b>EE</b> Alternate

Discount **BE**  
 Schedule Qty.: 25 pieces/listing  
 Unclass.

Example: **AML12CBB2EA**  
 Square, pushbutton switch housing; black bezel; red LED; .110 x .020 termination; current-sinking output for use with 5-volt supply; momentary action.

# Honeywell Sensing and Control AML/MML Selection Guide

## AML21 Electronic control pushbutton switches

### AML21 INCANDESCENT OR NON-LIGHTED DISPLAY ORDER GUIDE

<u>AML21B</u>	<u>B</u>	<u>A</u>	<u>2</u>	<u>AA</u>						
<b>Housing Type</b>	<b>Bezel Color</b>	<b>Incandescent Lamp Type</b>	<b>Terminal Type</b>	<b>Circuitry Codes (Each pole has double-throw)</b>						
<b>Standard Bezel</b> <b>AML21B</b> Square non-lighted <b>AML21C</b> Square 1 lamp ckt. <b>AML21E</b> Rect. non-lighted <b>AML21F</b> Rect. 1 lamp ckt. <b>AML21G</b> Rect. 2 lamp ckts.  <b>Full Guard Bezel</b> <b>AML21H</b> Square non-lighted <b>AML21J</b> Square 1 lamp ckt. <b>AML21K</b> Rect. non-lighted <b>AML21L</b> Rect. 1 lamp ckt. <b>AML21M</b> Rect. 2 lamp ckts.	<b>B</b> Black	<b>A</b> No lamp installed  <b>B</b> 6 V lamp  <b>C</b> 14 V lamp  <b>E</b> 28 V lamp	<b>2</b> .110 x .020 (solder or quick-connect)  <b>3</b> .025 x .025 (printed ckt. or push-on)	<table border="1" style="width: 100%;"> <tr> <td style="text-align: center;">Silver Contacts</td> <td> <b>Mom. Action.</b>  <b>AA</b> 1-pole  <b>AC</b> 2-pole  <b>CC</b> 4-pole   <b>Alt. Action</b>  <b>AB</b> 1-pole  <b>AD</b> 2-pole  <b>CD</b> 4-pole                 </td> </tr> <tr> <td style="text-align: center;">Gold Contacts</td> <td> <b>Mom. Action</b>  <b>BA</b> 1-pole  <b>BC</b> 2-pole  <b>DC</b> 4-pole   <b>Alt. Action</b>  <b>BB</b> 1-pole  <b>BD</b> 2-pole  <b>DD</b> 4-pole                 </td> </tr> <tr> <td style="text-align: center;">Gold-plated Silver Contacts</td> <td> <b>Mom. Action</b>  <b>EA</b> 1-pole  <b>EC</b> 2-pole                 </td> </tr> </table>	Silver Contacts	<b>Mom. Action.</b> <b>AA</b> 1-pole <b>AC</b> 2-pole <b>CC</b> 4-pole  <b>Alt. Action</b> <b>AB</b> 1-pole <b>AD</b> 2-pole <b>CD</b> 4-pole	Gold Contacts	<b>Mom. Action</b> <b>BA</b> 1-pole <b>BC</b> 2-pole <b>DC</b> 4-pole  <b>Alt. Action</b> <b>BB</b> 1-pole <b>BD</b> 2-pole <b>DD</b> 4-pole	Gold-plated Silver Contacts	<b>Mom. Action</b> <b>EA</b> 1-pole <b>EC</b> 2-pole
Silver Contacts	<b>Mom. Action.</b> <b>AA</b> 1-pole <b>AC</b> 2-pole <b>CC</b> 4-pole  <b>Alt. Action</b> <b>AB</b> 1-pole <b>AD</b> 2-pole <b>CD</b> 4-pole									
Gold Contacts	<b>Mom. Action</b> <b>BA</b> 1-pole <b>BC</b> 2-pole <b>DC</b> 4-pole  <b>Alt. Action</b> <b>BB</b> 1-pole <b>BD</b> 2-pole <b>DD</b> 4-pole									
Gold-plated Silver Contacts	<b>Mom. Action</b> <b>EA</b> 1-pole <b>EC</b> 2-pole									

Discount **BE**  
 Schedule Qty.: 25 pieces/listing  
 Unclass.

Example: **AML21BBA2AA**  
 Square, pushbutton switch housing, non-lighted; black bezel; .110 x .020 termination; 1-pole, double throw; silver contacts.

## AML22 Electronic control pushbutton switches

### AML22 LED DISPLAY ORDER GUIDE

<u>AML22C</u>	<u>B</u>	<u>B</u>	<u>2</u>	<u>AA</u>				
<b>Housing Type</b>	<b>Bezel Color</b>	<b>LED Color/ Voltage</b>	<b>Terminal Type</b>	<b>Circuitry Codes (Each pole has double-throw)</b>				
<b>Standard Bezel</b> <b>AML22C</b> Square 1 LED <b>AML22H</b> Square 1 high profile LED (for use with AML-52A buttons)  <b>Full Guard Bezel</b> <b>AML22J</b> Square 1 LED	<b>B</b> Black	<b>Red</b> <b>B</b> V <b>C</b> 5V <b>D</b> 10V <b>E</b> 15V <b>F</b> 24V  <b>Yellow</b> <b>H</b> V <b>J</b> 5V <b>K</b> 10V <b>L</b> 15V <b>M</b> 24V  <b>Green</b> <b>R</b> V <b>S</b> 5V <b>T</b> 10V <b>W</b> 15V <b>X</b> 24V	<b>2</b> .110 x .020 (solder or quick-connect)  <b>3</b> .025 x .025 (printed ckt. or push-on)  <b>8</b> .110 x .020 with diode protection	<table border="1" style="width: 100%;"> <tr> <td style="text-align: center;">Silver Contacts</td> <td> <b>Mom. Action.</b>  <b>AA</b> 1-pole  <b>AC</b> 2-pole   <b>Alt. Action</b>  <b>AB</b> 1-pole  <b>AD</b> 2-pole  <b>CD</b> 4-pole                 </td> </tr> <tr> <td style="text-align: center;">Gold Contacts</td> <td> <b>Mom. Action</b>  <b>BA</b> 1-pole  <b>BC</b> 2-pole   <b>Alt. Action</b>  <b>BB</b> 1-pole  <b>BD</b> 2-pole  <b>DD</b> 4-pole                 </td> </tr> </table>	Silver Contacts	<b>Mom. Action.</b> <b>AA</b> 1-pole <b>AC</b> 2-pole  <b>Alt. Action</b> <b>AB</b> 1-pole <b>AD</b> 2-pole <b>CD</b> 4-pole	Gold Contacts	<b>Mom. Action</b> <b>BA</b> 1-pole <b>BC</b> 2-pole  <b>Alt. Action</b> <b>BB</b> 1-pole <b>BD</b> 2-pole <b>DD</b> 4-pole
Silver Contacts	<b>Mom. Action.</b> <b>AA</b> 1-pole <b>AC</b> 2-pole  <b>Alt. Action</b> <b>AB</b> 1-pole <b>AD</b> 2-pole <b>CD</b> 4-pole							
Gold Contacts	<b>Mom. Action</b> <b>BA</b> 1-pole <b>BC</b> 2-pole  <b>Alt. Action</b> <b>BB</b> 1-pole <b>BD</b> 2-pole <b>DD</b> 4-pole							

Discount **BE**  
 Schedule Qty.: 25 pieces/listing  
 Unclass.

Example: **AML22CBB2AA**  
 Square, pushbutton switch housing with one LED, black bezel; red LED (without resistor); .110 x .020 termination; momentary action; 1-pole, double throw; silver contacts.

# Honeywell Sensing and Control AML/MML Selection Guide

## AML23 Solid state pushbutton switches

### AML23 INCANDESCENT OR NON-LIGHTED DISPLAY ORDER GUIDE

AML23E	B	A	2	AA	01
Housing Type	Operator/ Bezel Color	Incandescent Lamp Type	Terminal Type	Circuitry Codes	Operating Action
<b>AML23E</b> Rectangular non-lighted  <b>AML23F</b> Rectangular 1 lamp ckt. (A)  <b>AML23G</b> Rectangular 2 lamp ckts.(A & B)	<b>B</b> Black/Black	<b>A</b> No lamp installed  <b>B</b> 6 V lamp  <b>C</b> 14 V lamp  <b>E</b> 28 V lamp	<b>2</b> .110 x .020 (solder or quick-connect)  <b>3</b> .025 x .025 (printed, ckt. or push-on)	<b>Silver Contacts</b> <b>AA</b> 1-pole① <b>AC</b> 2-pole① <b>CA</b> 2-pole <b>CC</b> 4-pole①  <b>Gold Contacts</b> <b>BA</b> 1-pole  Insert code letters as shown in Circuitry Chart	No charge  Insert Code numbers from Operating Action Chart

Discount **BE**  
Schedule Qty.: **25** pieces/listing  
Unclass.

Example: **AML23EBA2AA01**  
Rectangular, non-lighted paddle switch housing; black paddle and bezel;  
.110 x .020 terminals; with one circuit ON and one circuit OFF in each extreme  
operator position (maintained).

① for non-illuminated switches only.

### CIRCUITRY

Silver Contacts	Gold Contacts	2-Position		3-Position			
<b>AA</b>	<b>BA</b>						
<b>AC</b>	<b>BC</b>						
<b>CA</b>	<b>DA</b>						
<b>CC</b>	<b>CC</b>						

### OPERATING ACTION

2-Position		
Maint.	<b>01</b> None	Maint.
Mom.	<b>02</b> None	Maint.
Maint.	<b>03</b> None	Mom.
3-Position		
Maint.	<b>04</b> Maint.	Maint.
Mom.	<b>05</b> Maint.	Mom.
Maint.	<b>06</b> Maint.	Mom.
Mom.	<b>07</b> Maint.	Maint.

# Honeywell Sensing and Control AML/MML Selection Guide

## AML25 Electronic control paddle switches

### AML25 LED DISPLAY ORDER GUIDE

AML25F	B	B	2	AA	01	R	X
Housing Type	Operator/ Bezel Color	LED Voltage	Terminal Type/ Diode Protection	Circuitry Codes	Operating Code	LED Color (LED A)	LED Color (LED B)
<b>AML25F</b> Rectangular 1 LED  <b>AML25G</b> Rectangular 2 LEDs	<b>B</b> Black/Black	<b>B</b> V  <b>C</b> 5 V  <b>D</b> 10 V  <b>E</b> 15 V  <b>F</b> 24 V	<b>2</b> .110 x .020 (solder or quick-connect)  <b>3</b> .025 x .025 (printed ckt. or push-on)  <b>8</b> .110 x .020 with diode protection	<b>Silver Contacts</b> <b>AA</b> 1-pole  <b>CA</b> 2-pole  <b>Gold Contacts</b> <b>BA</b> 1-pole  <b>DA</b> 2-pole  Insert code letters as shown in Circuitry Chart	No charge  Insert code numbers from Operating Action Chart	<b>R</b> Red  <b>Y</b> Yellow  <b>G</b> Green  <b>X</b> No LED	<b>R</b> Red  <b>Y</b> Yellow  <b>G</b> Green  <b>X</b> No LED

Discount **BE**  
 Schedule Qty.: 25 pieces/listing  
 Unclass.

Example: **AML25FBB2AA01RX**  
 Rectangular paddle switch; illuminated with one red LED, this device has a black paddle and bezel, and .110 x .020 terminals; with one circuit ON and one circuit OFF in each extreme operator position (maintained).

### CIRCUITRY

Silver Contacts		Gold Contacts		2-Position		3-Position		
<b>AA</b>	<b>BA</b>							
<b>AC</b>	<b>BC</b>							
<b>CA</b>	<b>DA</b>							
<b>CC</b>	<b>CC</b>							

### OPERATING ACTION

2-Position		
Maint.	<b>01</b> None	Maint.
Mom.	<b>02</b> None	Maint.
Maint.	<b>03</b> None	Mom.
3-Position		
Maint.	<b>04</b> Maint.	Maint.
Mom.	<b>05</b> Maint.	Mom.
Maint.	<b>06</b> Maint.	Mom.
Mom.	<b>07</b> Maint.	Maint.

# Honeywell Sensing and Control AML/MML Selection Guide

## AML24 Electronic control rocker switches

### AML24 INCANDESCENT OR NON-LIGHTED DISPLAY ORDER GUIDE

AML24E	B	A	2	AA	01
<b>Housing Type</b>	<b>Bezel Color</b>	<b>Incandescent Lamp Type</b>	<b>Terminal Type</b>	<b>Circuitry Codes</b>	<b>Operating Action</b>
<b>AML24E</b> Rectangular non-lighted  <b>AML24F</b> Rectangular 1 lamp ckt. (A)  <b>AML24G</b> Rectangular 2 lamp ckts.	<b>B</b> Black	<b>A</b> No lamp installed  <b>B</b> 6 V lamp  <b>C</b> 14 V lamp  <b>E</b> 28 V lamp	<b>2</b> .110 x .020 (solder or quick-connect)  <b>3</b> .025 x .025 (printed ckt. or push-on)	<b>Silver Contacts</b> <b>AA</b> 1-pole <b>AC</b> 2-poleⓁ <b>CA</b> 2-pole <b>CC</b> 4-poleⓁ  <b>Gold Contacts</b> <b>BA</b> 1-pole <b>BC</b> 2-poleⓁ <b>DA</b> 2-pole <b>DC</b> 4-poleⓁ  Insert Code letters as shown in Circuitry Chart	No charge  Insert Code numbers from Operating Action Chart

Discount **BE**  
 Schedule Qty.: **25** pieces/listing  
 Unclass.

Example: **AML24EBA2AA01**  
 Rectangular, non-lighted rocker switch housing; black bezel; 110 x .020 terminals;  
 .with one circuit ON and one circuit OFF in each extreme operator position (maintained).

Ⓛ for non-illuminated switches only.

### CIRCUITRY

Silver Contacts		Gold Contacts		2-Position		3-Position			
<b>AA</b>	<b>BA</b>								
<b>AC</b>	<b>BC</b>								
<b>CA</b>	<b>DA</b>								
<b>CC</b>	<b>DC</b>								

### OPERATING ACTION

2-Position		
Maint.	<b>01</b> None	Maint.
Mom.	<b>02</b> None	Maint.
Maint.	<b>03</b> None	Mom.
3-Position		
Maint.	<b>04</b> Maint.	Maint.
Mom.	<b>05</b> Maint.	Mom.
Maint.	<b>06</b> Maint.	Mom.
Mom.	<b>07</b> Maint.	Maint.

# Honeywell Sensing and Control AML/MML Selection Guide

## AML26 Electronic control rocker switches\*\*

### AML26 LED DISPLAY ORDER GUIDE

AML26F	B	B	2	AA	01	R	X
Housing Type	Bezel Color	LED Voltage	Terminal Type/ Diode Protection	Circuitry Codes	Operating Action	LED Color (LED A)	LED Color (LED B)
AML26F 1 LED	B Black	B V	2 .110 x .020 (solder or quick-connect)	<b>Silver Contacts</b> AA 1-pole CA 2-pole	Insert code numbers from Operating Action Chart	R Red	R Red
AML26G 2 LEDs		C 5 V	3 .025 x .025 (printed ckt. or push-on)	<b>Gold Contacts</b> BA 1-pole DA 2-pole		Y Yellow	Y Yellow
		D 10 V	8 .110 x .020 with diode protection	Insert Code letters as shown in Circuitry Chart		G Green	G Green
		E 15 V				X No LED	X No LED
		F 24 V					

Discount **BE**

Schedule Qty.: 25 pieces/listing  
Unclass.

Example: **AML26FBB2AA01RX**

Rectangular rocker switch; illuminated with one LED, this device has a black bezel, .110 x .020 terminals; with one circuit ON and one circuit OFF in each extreme operator position (maintained).

\*\* **NOTE:** Contact Customer Service for minimum quantity required to establish or reinstate a catalog listing.

### CIRCUITRY

Silver Contacts	Gold Contacts	2-Position		3-Position			
AA	BA						
AC	BC						
(Non-illuminated switches only)							
CA	DA						
CC	DC						
(Non-illuminated switches only)							

### OPERATING ACTION

<b>2-Position</b>			
Maint.	01 None		Maint.
Mom.	02 None		Maint.
Maint.	03 None		Mom.
<b>3-Position</b>			
Maint.	04 Maint.		Maint.
Mom.	05 Maint.		Mom.
Maint.	06 Maint.		Mom.
Mom.	07 Maint.		Maint.

# Honeywell Sensing and Control AML/MML Selection Guide

## AML27 Electronic control keylock switches \*\*\*\*

### AML27 NON-LIGHTED ORDER GUIDE

AML27A	B	K	2	AA	21	BA		
<b>Housing Type</b>	<b>Bezel Color</b>	<b>Button Color</b>	<b>Terminal Type</b>	<b>Circuitry Codes (each pole has double throw)</b>	<b>Operation Action (key out in center position, except where noted)</b>		<b>Key Combinations</b>  (Two keys furnished)	
<b>AML27A</b> Square housing non-lighted	<b>B</b> Black	<b>K</b> Black	<b>2</b> .110 x .020 (solder or quick-connect)  <b>3</b> .025 x .025 (printed circuit or push-on)	<b>Silver Contacts</b> <b>AA</b> 1-pole  <b>AC</b> 2-pole  <b>Gold Contacts</b> <b>BA</b> 1-pole  <b>BC</b> 2-pole	<b>CCW</b>	<b>Center</b>		<b>CW</b>
					None	<b>21</b> Maint.	Maint.	<b>BA</b> <b>BB</b> <b>BK</b> <b>BC</b> <b>BL</b> <b>BD</b> <b>BE</b> <b>BS</b> <b>BF</b> <b>BW</b>
					None	<b>22*</b> Maint.	Maint.	
					None	<b>23</b> Maint.	Mom.	
					Maint.	<b>24</b> Maint.	Maint.	
					Mom.	<b>25</b> Maint.	Mom.	
					Maint.	<b>26**</b> Maint.	Maint.	
					Mom.	<b>27***</b> Maint.	Maint.	
					Maint.	<b>28***</b> Maint.	Maint.	
					Maint.	<b>29†</b> Maint.	Maint.	
					Maint.	<b>30†</b> Maint.	Mom.	
					Maint.	<b>31††</b> Maint.	Mom.	

Discount **BE**  
 Schedule Qty: 25 pieces/listing  
 Unclass.

#### REPLACEMENT KEYS

One key per listing  
 Five piece minimum order quantity for keys

Key Combination	Key Code	Catalog Listing
BA	110	30PA101-AML
BB	109	30PA102-AML
BD	107	30PA104-AML
BE	106	30PA105-AML
BS	117	30PA117-AML
BT	118	30PA118-AML
BV	119	30PA119-AML
BW	120	30PA120-AML

Note: These keys fit the 5-bit keylocks in the Order Guide



Specify different key combinations to acquire different keys, i.e.:

AML27ABK2AA21**BB** and AML27ABK2AA21**BE** have different keys.  
 AML27ABK2AA21**BB** and AML27ABK3BC25**BB** have identical interchangeable keys.

**28** and **29** operating actions should be used with key combinations BA or BB.

Example: **AML27ABK2AA21BA** Square housing; black bezel and button; .110 x .020 terminals; 2-pole double-throw; silver contacts; 3-position maintained and key code "BB".

\*\*\*\* **NOTE:** Contact Customer Service for minimum quantity required to establish or reinstate a catalog listing.



# Honeywell Sensing and Control AML/MML Selection Guide

## AML31 Power duty pushbutton switches\*

### AML31 INCANDESCENT OR NON-LIGHTED DISPLAY ORDER GUIDE

<u>AML31E</u>	<u>B</u>	<u>A</u>	<u>4</u>	<u>AC</u>		
Housing Type	Bezel Color	Incandescent Lamp Type	Terminal Type	Circuitry Codes		
<b>Standard Bezel</b> <b>AML31E</b> Rect. non-lighted <b>AML31F</b> Rect. 1 lamp ckt.  <b>Full Guard Bezel</b> <b>AML31L</b> Rect. 1 lamp ckt.	<b>B</b> Black	<b>A</b> No lamp installed  <b>B</b> 6 V lamp  <b>C</b> 14 V lamp  <b>E</b> 28 V lamp	<b>4</b> .187 x .020 (solder or quick-connect)	2-pole, single-throw, normally open, Form X  <table border="0" style="width: 100%;"> <tr> <td style="text-align: center; width: 50%;"><b>AD</b> Alt. action</td> <td style="text-align: center; width: 50%;"><b>AC</b> Mom. Action</td> </tr> </table>	<b>AD</b> Alt. action	<b>AC</b> Mom. Action
<b>AD</b> Alt. action	<b>AC</b> Mom. Action					

Discount **BE**  
 Schedule Qty.: **25** pieces/listing  
 Unclass.

Example: **AML31EBA4AC**  
 Rectangular pushbutton switch housing, non-lighted; black bezel; .187 x .020 terminals; momentary action; 2-pole, single-throw, normally open, Form X

\* **NOTE:** Contact Customer Service for a minimum quantity required to establish or reinstate a catalog listing.

## AML32 Power duty pushbutton switches\*

### AML32 NEON DISPLAY ORDER GUIDE

<u>AML32F</u>	<u>B</u>	<u>C</u>	<u>7</u>	<u>AA</u>		
Housing Type	Bezel Color	Neon Lamp Voltage/Color	Terminal Type Lamp Circuit	Circuitry Codes		
<b>Standard Bezel</b> <b>AML32F</b> Rect. 1 Neon lamp  <b>Full Guard Bezel</b> <b>AML32L</b> Rect. 1 Neon lamp	<b>B</b> Black	<b>Red</b> <b>B</b> 125 VAC <b>C</b> 250 VAC  <b>Clear</b> <b>K</b> 125 VAC <b>L</b> 250 VAC  <b>Green</b> <b>M</b> 125 VAC <b>P</b> 250 VAC	<b>4</b> .187 x .020 (solder or quick-connect) with isolated lamp circuit  <b>7</b> .187 x .020 with integral lamp circuit	2-pole, single-throw, normally open, Form X  <table border="0" style="width: 100%;"> <tr> <td style="text-align: center; width: 50%;"><b>AD</b> Alt. action</td> <td style="text-align: center; width: 50%;"><b>AC</b> Mom. Action</td> </tr> </table>	<b>AD</b> Alt. action	<b>AC</b> Mom. Action
<b>AD</b> Alt. action	<b>AC</b> Mom. Action					

Discount **BE**  
 Schedule Qty.: **25** pieces/listing  
 Unclass.

Example: **AML32FBC7AC**  
 Rectangular pushbutton switch housing; black bezel; 250 volt, red neon lamp; .187 x .020 terminals with integral lamp circuit; momentary action; 2-pole, single-throw, normally open, Form X

\* **NOTE:** Contact Customer Service for minimum quantity required to establish or reinstate a catalog listing.

# Honeywell Sensing and Control AML/MML Selection Guide

## AML33 Power duty paddle switches\*

### AML33 INCANDESCENT OR NON-LIGHTED DISPLAY ORDER GUIDE

<b>AML33E</b>	<b>B</b>	<b>A</b>	<b>4</b>	<b>AA</b>	<b>01</b>
Housing Type	Operator/ Bezel Color	Incandescent Lamp Type	Terminal Type	Circuitry Codes	Operating Action
<b>AML33E</b> Rectangular non-lighted  <b>AML33F</b> Rectangular 1 lamp ckt.	<b>B</b> Black/Black	<b>A</b> No lamp installed	<b>4</b> .187 x .020 (solder or quick-connect)	<b>Silver Contacts</b> <b>AA</b> 1-pole (one Form A single-throw, normally open)  <b>AC</b> 2-pole (Two Form A)	  <b>01</b> Maint. ON    Maint. OFF

Discount **BE**  
 Schedule Qty.: **25** pieces/listing  
 Unclass.

Example: **AML33EBA4AA01**  
 Rectangular, non-lighted device; black paddle and bezel; .187 x .020 terminals; 1-pole, Form A Single Throw; with one circuit ON in one extreme position and OFF in the other.

\* **NOTE:** Contact Customer Service for a minimum quantity required to establish or reinstate a catalog listing.

## AML34 Power duty rocker switches\*

### AML34 INCANDESCENT OR NON-LIGHTED DISPLAY ORDER GUIDE

<b>AML34E</b>	<b>B</b>	<b>A</b>	<b>4</b>	<b>AA</b>	<b>01</b>
Housing Type	Bezel Color	Incandescent Lamp Type	Terminal Type	Circuitry Codes	Operating Action
<b>AML34E</b> Rectangular non-illum.  <b>AML34F</b> Rectangular 1 lamp ckt.	<b>B</b> Black	<b>A</b> No lamp installed	<b>4</b> .187 x .020 (solder or quick-connect)	<b>Silver Contacts</b> <b>AA</b> 1-pole (one Form A single-throw, normally open)  <b>AC</b> 2-pole (Two Form A)	  <b>01</b> Maint. ON    Maint. OFF

Discount **BE**  
 Schedule Qty.: **25** pieces/listing  
 Unclass.

Example: **AML34EBA4AA01**  
 Rectangular, non-illuminated device; black paddle and bezel; .187 x .020 terminals; 1-pole, Form A single throw; with one circuit ON in one extreme position and OFF in the other.

\* **NOTE:** Contact Customer Service for a minimum quantity required to establish or reinstate a catalog listing.

# Honeywell Sensing and Control AML/MML Selection Guide

## AML35 Power duty paddle switches\*

### AML35 NEON DISPLAY ORDER GUIDE

<b>AML35F</b>	<b>B</b>	<b>B</b>	<b>4</b>	<b>AA</b>	<b>01</b>
Housing Type	Operator/ Bezel Color	Neon Lamp Voltage	Terminal Type/ Lamp Circuit	Circuitry Codes	Operating Action
<b>AML35F</b> Rectangular 1 neon lamp	<b>B</b> Black/Black	<b>Red</b> <b>B</b> 125 VAC	<b>4</b> .187 x .020 (solder or quick-connect) with isolated lamp circuit  <b>7</b> .187 x .020 with integral lamp circuit (available with 2-pole devices only)	<b>Silver Contacts</b> <b>AA</b> (One Form A single-throw) Available only with isolated lamp circuit, term. type 4  <b>AC</b> 2-pole (Two Form A)	 <b>01</b> Maint. ON    Maint. OFF

Discount **BE**  
Schedule Qty.: **25** pieces/listing  
Unclass.

Example:**AML35FBB4AA01**  
Rectangular paddle switch housing; black paddle and bezel; 125 VAC neon lamp; .187 x .020 terminals with isolated lamp circuit; 1-pole, Form A single throw; with circuit ON in one extreme position and OFF in the other (maintained).

\* **NOTE:** Contact Customer Service for a minimum quantity required to establish or reinstate a catalog listing.

## AML36 Power duty rocker switches\*

### AML36 NEON DISPLAY ORDER GUIDE

<b>AML36F</b>	<b>B</b>	<b>B</b>	<b>4</b>	<b>AA</b>	<b>01</b>
Housing Type	Bezel Color	Neon Lamp Voltage	Terminal Type/ Lamp Circuit	Circuitry Codes	Operating Action
<b>AML36F</b> Rectangular 1 neon lamp	<b>B</b> Black	<b>Red</b> <b>B</b> 125 VAC  <b>C</b> 250 VAC	<b>4</b> .187 x .020 (solder or quick-connect) with isolated lamp circuit  <b>7</b> .187 x .020 with integral lamp circuit (available with 2-pole devices only)	<b>Silver Contacts</b> <b>AA</b> (One Form A single-throw) Available only with isolated lamp circuit, term. type 4.  <b>AC</b> 2-pole (Two Form A)	 <b>01</b> Maint. ON    Maint. OFF

Discount **BE**  
Schedule Qty.: **25** pieces/listing  
Unclass.

Example:**AML36FBB4AA01**  
Rectangular rocker switch housing; black bezel; 125 VAC neon lamp; .187 x .020 terminals with isolated lamp circuit; 1-pole Form A single throw; with circuit ON in one extreme position and OFF in the other.

\* **NOTE:** Contact Customer Service for a minimum quantity required to establish or reinstate a catalog listing.

# Honeywell Sensing and Control AML/MML Selection Guide

## AML41/42 Lighted indicators\*

### AML41 INCANDESCENT DISPLAY INDICATORS ORDER GUIDE

<b>AML41C</b>		<b>B</b>	<b>A</b>	<b>2</b>	
Housing Type		Bezel Color	Incand. Lamp Type	Terminal Type	
<b>Pushbutton Style</b>	<b>Lens Style</b>	<b>B</b> Black	<b>A</b> No lamp installed	<b>2</b> .110 x .020 (solder or quick-connect)	Discount <b>BE</b> Schedule Qty.: 25 pieces/listing Unclass.  Example: <b>AML41CBA2</b> Square (pushbutton style) indicator housing with one lamp circuit; black bezel; .110 x .020 termination.  * <b>NOTE:</b> Contact Customer Service for a minimum quantity required to establish or reinstate a catalog listing.
<b>AML41C</b> Square 1 lamp ckt.	(Use AML51-J, -K, and -L buttons only)		<b>B</b> 6 V lamp	<b>3</b> .025 x .025 (printed circuit or push-on)	
<b>AML41D</b> Square, 2 lamp ckts.	<b>AML41J</b> Rectangular 1 lamp ckt.		<b>C</b> 14 V lamp		
<b>AML41F</b> Rectangular 1 lamp ckt.	<b>AML41K</b> Rectangular 2 lamp ckts.		<b>E</b> 28 V lamp		
<b>AML41G</b> Rectangular 2 lamp ckts.	<b>AML41L</b> Rectangular 3 lamp ckts.				

### AML42 LED DISPLAY INDICATORS ORDER GUIDE

<b>AML42S</b>	<b>B</b>	<b>C</b>	<b>2</b>		
Housing Type	Bezel Color	LED Color/ Voltage	Terminal Type/ Diode Protection		
<b>AML42C</b> Square 1 LED	<b>B</b> Black	<b>Red</b> <b>B</b> V <b>C</b> 5V <b>E</b> 15V <b>F</b> 24V	<b>2</b> .110 x .020 (solder or q.c.)	<b>8</b> .110 x .020 with diode protection	Discount <b>BE</b> Schedule Qty.: 25 pieces/listing Unclass.  Example: <b>AML42SBC2</b> Compact indicator with black bezel; 5 volt red LED; .110 x .020 termination.  * <b>NOTE:</b> Contact Customer Service for a minimum quantity required to establish or reinstate a catalog listing.
<b>AML42S</b> Rectangular 1 LED		<b>Yellow</b> <b>H</b> V* <b>J</b> 5V <b>L</b> 15V <b>M</b> 24V	<b>3</b> .025 x .025 (printed circuit or push-on)		
<b>AML42J</b> Full guard bezel with 1 LED		<b>Green</b> <b>R</b> V <b>S</b> 5V <b>W</b> 15V <b>X</b> 24V			
<b>AML42K</b> Full guard bezel with high profile LED					

# Honeywell Sensing and Control AML/MML Selection Guide

## AML45 Solid state LED annunciators\*

### AML45 ORDER GUIDE

AML45S	W	A	2	RY	
Housing Type	Color of Housing Bezel	LED Voltage	Terminal Type	LED Color	
<b>AML45R</b> 2 LEDs (for use with full-screen)	<b>W</b> White	<b>A</b> 2.4 V	<b>2</b> .110 x .020 (solder or quick-connect)	<b>Side 1</b>	<b>Side 2</b>
<b>AML45S</b> 2 LEDs (for use with split-screen)	<b>K</b> Black	<b>C</b> 10 V	<b>3</b> 0.25 x 0.25 (printed circuit)	<b>R</b> Red	<b>R</b> Red
		<b>D</b> 15 V	<b>8</b> .110 x .020 with diode protection	<b>Y</b> Yellow	<b>Y</b> Yellow
		<b>F</b> 24 V		<b>G</b> Green	<b>G</b> Green
		<b>*K</b> 15 V High Intensity		<b>A</b> Amber	<b>A</b> Amber
				<b>H</b> Red	<b>H</b> Red

Discount **BE**  
 Schedule Qty.: 25 pieces/listing  
 Unclass.

Example: **AML45SWA2RY**  
 Split-screen type housing with white bezel, 2.4 V LEDs, .110 x .020 termination; red LED in side 1 and yellow LED in side 2

\*K must have two LEDs – uses A or H LEDs only

**SPACERS:** 30PA1-AML (package of 10) - unclassified

\* **NOTE:** Contact Customer Service for a minimum quantity required to establish or reinstate a catalog listing.

## AML51 Button Parts

### Catalog Listing Description

Full Filter – Square Translucent ▲  
 AML51- Z1 Red  
 -Z2 Yellow  
 -Z3 Green  
 -Z5 White

Full Filter – Rectangular Translucent ▲  
 AML51- Z6 Red  
 -Z7 Yellow  
 -Z8 Green

Split Filter – Rectangular Translucent ▲  
**Catalog listing includes two splits**  
 AML51- Z16 Red  
 -Z20 White

Split Filter – Rectangular Translucent ■  
**Catalog listing includes two splits**  
 AML51- Z42 Red  
 -Z43 Yellow  
 -Z44 Green  
 -Z46 Clear

Discount **BE**  
 Schedule Qty.: 25 pieces/listing  
 Unclass.

Five piece minimum order quantity

- ▲ For use with Clear Cap and Dead Front Buttons
- For use with Projected Color Buttons

**NOTE:** Projected color buttons are the AML51-C10W and AML51-F10W

# Honeywell Sensing and Control AML/MML Selection Guide

## AML51/52 Lens/Buttons

AML51 LENS ORDER GUIDE (for incandescent display AML41J, K and L indicators)

AML51J		10		R		Discount BE Schedule Qty.: 25 pieces/listing Unclass.
Button Type (Lens style)	Display/Legend Type	Full color or 1st color split	2nd color split	3rd color split		
 <b>AML51-J</b>	<b>Transmitted Color</b> <b>10</b> No legend <b>20</b> With legend	<b>R</b> Red	<b>R</b> Red	<b>R</b> Red	Five piece minimum order quantity for buttons  Example: <b>AML51-J10R</b> Rectangular lens-type button; full color; transmitted color, no legend; red	
 <b>AML51-K</b>	<b>Transmitted Color</b> (clear cap & color insert) <b>11</b> No legend <b>21</b> With legend	<b>Y</b> Yellow	<b>Y</b> Yellow	<b>Y</b> Yellow		
 <b>AML51-L</b>	<b>Dead Front</b> (smoky gray cap & color insert) <b>30</b> No legend <b>40</b> With legend	<b>G</b> Green	<b>G</b> Green	<b>G</b> Green		
	<b>Projected color</b> (white cap & color insert) <b>50</b> No legend <b>60</b> With legend	<b>B</b> Blue  <b>W</b> White  <b>A**</b> Amber	<b>B</b> Blue  <b>W</b> White  <b>A**</b> Amber	<b>B</b> Blue  <b>W</b> White  <b>A**</b> Amber		

\*\* Not available in projected color  
Not all color combinations are available for two and three piece buttons

## AML51 Buttons for switches and indicators

AML51 PUSH BUTTON ORDER GUIDE

AML51-C			10		R		-	
Button Type (Push Button Type)			Display/Legend Type		Full Color or 1st Color Split		2nd Color Split	
For switches or indicators:   <b>AML51-C</b>			<b>Transmitted Color</b> <b>10</b> No legend <b>20</b> With legend  <b>Transmitted Color</b> (clear cap & color insert) <b>11</b> No legend <b>21</b> with legend  <b>Dead Front</b> (smoky gray cap & color insert) <b>30</b> No legend <b>40</b> with legend  <b>Projected color</b> (white cap & color insert) <b>50</b> No legend <b>60</b> with legend	<b>R</b> Red  <b>Y</b> Yellow  <b>G</b> Green  <b>B</b> Blue  <b>W</b> White  <b>K***</b> Black  <b>L***</b> Gray  <b>A**</b> Amber	<b>R</b> Red  <b>Y</b> Yellow  <b>G</b> Green  <b>B</b> Blue  <b>W</b> White  <b>K***</b> Black  <b>L***</b> Gray  <b>A**</b> Amber			
 <b>AML51-F</b>								
 <b>AML51-G</b>								
 <b>AML51-A</b>								
 <b>AML51-H</b>								
 <b>AML51-N†</b>								
 <b>AML51-M</b>								
 <b>AML51-E</b>								
 <b>AML51-R</b>								
For indicators only   <b>AML51-D</b> <small>*Available with transmitted color (10 or 20) only</small>			<small>** Available with transmitted and dead-front only            *** Black and gray not recommended for lighted display            † AML51-N buttons not available with Display/Legend Types 10 and 20            Note: Dimensions include the .060 in bezel</small>					
			Example: <b>AML51-C10R</b> Square full color button; with transmitted color, no legend; red					

**NOTE:** AML51 has a \$6.00 net each recurring set-up charge per legend. A one-time charge of \$70.00 applies to establish a new graphic legend.

# Honeywell Sensing and Control AML/MML Selection Guide

## AML52 Buttons

### AML52 BUTTON ORDER GUIDE (for LED/Neon display)

AML52-N	10	R	
<b>Button Type</b>	<b>Display/Legend Type (see note)</b>	<b>Button Color</b>	
<p><b>For LED Devices</b> <b>AML52-A</b></p>  <p><b>AML52-C*</b></p> 	<p style="text-align: center;"><b>Transmitted Color</b></p> <p style="text-align: center;"><b>10</b> No legend</p> <p style="text-align: center;"><b>20</b> with legend</p> <p><b>NOTE:</b> AML52 and AML53 have \$6.00 net each recurring set-up charge per legend. A one-time charge of \$70.00 applies to establish a new graphic legend.</p>	<p style="text-align: center;"><b>R</b> Red</p> <p style="text-align: center;"><b>Y</b> Yellow</p> <p style="text-align: center;"><b>G</b> Green</p> <p style="text-align: center;"><b>B</b> Blue</p> <p style="text-align: center;"><b>W</b> White</p> <p style="text-align: center;"><b>K</b> Black</p> <p style="text-align: center;"><b>L</b> Gray</p>	<p>Discount <b>BE</b> Schedule Qty.: <b>25</b> pieces/listing Unclass.</p> <p>Five piece minimum order quantity for buttons</p> <p>Example: <b>AML52-N10R</b> Rectangular full screen; for use on neon power switch with transmitted color, no legend; red button.</p>
<p><b>For Neon Devices</b> <b>AML52-N</b></p> 			

\* Not available for lighted display

## AML53 Covers for paddle switches

### AML53 PADDLE SWITCH COVER ORDER GUIDE (for incandescent or non-lighted display)

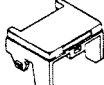
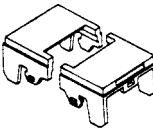
AML53-T	10	R	G	
<b>Paddle Switch Cover Type</b>	<b>Display/Legend Type</b>	<b>Cover Color</b>		
<p></p> <p><b>AML53-E</b> ½ Cover</p> <p></p> <p><b>AML53-T</b> Two-piece cover</p>	<p style="text-align: center;"><b>Transmitted Color</b></p> <p style="text-align: center;"><b>10</b> No legend <b>20</b> With legend</p> <p style="text-align: center;"><b>Transmitted Color</b> (clear cap &amp; color insert)</p> <p style="text-align: center;"><b>11</b> No legend <b>21</b> with legend</p> <p style="text-align: center;"><b>Dead Front</b> (smoky gray cap &amp; color insert)</p> <p style="text-align: center;"><b>30</b> No legend <b>40</b> with legend</p> <p style="text-align: center;"><b>Projected color</b> (white cap &amp; color insert)</p> <p style="text-align: center;"><b>50</b> No legend <b>60</b> with legend</p>	<b>½ cover or one side of two-piece cover</b>	<b>Other side of two-piece cover</b>	<p><b>Use only with "T" Covers</b></p> <p>Discount <b>BE</b> Schedule Qty.: <b>25</b> pieces/listing Unclass.</p> <p>Five piece minimum order quantity for buttons</p> <p>Example: <b>AML53-T10RG</b> Two-piece cover; with transmitted color, no legend; red and green.</p> <p><b>NOTE:</b> AML52 and AML53 have \$6.00 net each recurring set-up charge per legend. A one-time charge of \$70.00 applies to establish a new graphic legend.</p> <p>* Not for lighted display ** Not available with projected color</p>
		<p style="text-align: center;"><b>R</b> Red</p> <p style="text-align: center;"><b>Y</b> Yellow</p> <p style="text-align: center;"><b>G</b> Green</p> <p style="text-align: center;"><b>B</b> Blue</p> <p style="text-align: center;"><b>W</b> White</p> <p style="text-align: center;"><b>K*</b> Black</p>	<p style="text-align: center;"><b>R</b> Red</p> <p style="text-align: center;"><b>Y</b> Yellow</p> <p style="text-align: center;"><b>G</b> Green</p> <p style="text-align: center;"><b>B</b> Blue</p> <p style="text-align: center;"><b>W</b> White</p> <p style="text-align: center;"><b>K*</b> Black</p>	

# Honeywell Sensing and Control AML/MML Selection Guide

## AML54 Rocker switch operators

AML54 ROCKER OPERATOR ORDER GUIDE (for incandescent or non-lighted display)

AML54-F	10	R		
Rocker Operator Type	Display/Legend Type	Rocker Color		
 <p><b>AML54-F</b> Full rocker</p>	<p><b>Transmitted Color</b> 10 No legend 20 With legend</p> <p><b>Transmitted Color</b> (clear cap &amp; color insert) 11 No legend 21 with legend</p> <p><b>Dead Front</b> (smoky gray cap &amp; color insert) 30 No legend 40 with legend</p> <p><b>Projected color</b> (white cap &amp; color insert) 50 No legend 60 with legend</p>	<p><b>Full rocker, ½ rocker, or one side of two-piece rockers</b></p> <p>R Red Y Yellow G Green B Blue W White K* Black L* Gray A** Amber</p>	<p><b>Other side of two-piece rockers</b></p> <p>R Red Y Yellow G Green B Blue W White K* Black L* Gray A** Amber</p>	<p>Discount <b>BE</b></p> <p>Schedule Qty.: <b>25</b> pieces/listing Unclass.</p> <p>Five piece minimum order quantity for buttons</p> <p>Example: <b>AML54-F10R</b> Full rocker; with transmitted color, no legend; red</p> <p>NOTE: AML54 and AML55 have \$6.00 net each recurring set-up charge per legend. A one-time charge of \$70.00 applies to establish a new graphic legend.</p> <p>* Not for lighted display ** Not available with projected color † Not available for use with AML34 power switches</p>
 <p><b>AML54-E</b> ½ rocker</p>				
 <p><b>AML54-T</b> Two-piece rocker</p>				

## AML55 Covers for paddle switches

AML55 PADDLE SWITCH COVER ORDER GUIDE (for neon display)

AML55-N	10	R	Y	
Paddle Switch Cover Type	Display/Legend Type (see note)	Lens Color	Cover Color	
 <p><b>AML55-N</b> Full neon cover with colored lens</p>	<p><b>Transmitted Color</b></p> <p>10 No legend 20 with legend</p>	<p>T Clear R Red</p>	<p>R Red Y Yellow G Green B Blue W White K Black L Gray</p>	<p>Discount <b>BE</b></p> <p>Schedule Qty.: <b>25</b> pieces/listing Unclass.</p> <p>Five piece minimum order quantity for buttons</p> <p>AML55-N covers have a colored lenticular lens window which extends over the neon lamp.</p> <p>Example: <b>AML55-N10RY</b> Full neon paddle switch cover; with transmitted color, no legend; red lens and yellow cover.</p>



# Honeywell Sensing and Control AML/MML Selection Guide

## AML55 Covers for paddle switches

### AML55 PADDLE SWITCH COVER ORDER GUIDE (for LED display)

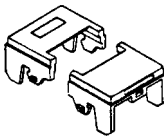
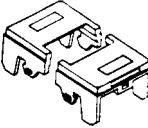
AML55-T	10	Y	R	See notes below
<b>Paddle Switch Cover Type</b>   <b>AML55-E</b> 1/2 cover (for 1 LED)*	<b>Display/Legend Type</b>  <b>Transmitted Color</b> 10 No legend 20 With legend	<b>Cover Color</b>		Discount <b>BE</b>  Schedule Qty.: <b>25</b> pieces/listing Unclass.  Five piece minimum order quantity for button.  AML55-E, -T, and -H covers have an open window which allows LEDs to be flush with the cover surface.  *NOTES: <sup>1</sup> Only one color code letter is necessary for AML55-E 1/2 covers  <sup>2</sup> To order a 1/2-cover without the LED "window," specify an AML53-E listing.  Example: <b>AML55-T10YR</b> Two-piece cover; with LED window in one side, transmitted color, no legend; yellow (LED side) and red (non-LED side).  NOTE: AML55 has a net \$6.00 recurring set-up charge per legend. A one-time charge of \$70.00 applies to establish a new graphic legend.
 <b>AML55-T</b> Two-piece cover (for one LED)		1/2 cover or LED side of two-piece covers*  <b>R</b> Red  <b>Y</b> Yellow  <b>G</b> Green  <b>B</b> Blue  <b>W</b> White  <b>K</b> Black  <b>L</b> Gray	Other side of two-piece covers  <b>R</b> Red  <b>Y</b> Yellow  <b>G</b> Green  <b>B</b> Blue  <b>W</b> White  <b>K</b> Black  <b>L</b> Gray	
 <b>AML55-H</b> Two-piece cover (for two LEDs)				

# Honeywell Sensing and Control AML/MML Selection Guide

## AML56 Rocker switch operators

### AML56 ROCKER OPERATOR ORDER GUIDE (for neon display)

AML56-N	10	R	Y	
<b>Rocker Operator Type</b>  <b>AML56-N</b> Full rocker with colored lens	<b>Display/Legend Type</b> <b>Transmitted Color</b> 10 No legend 20 with legend	<b>Lens Color</b> T Clear R Red Y Yellow	<b>Rocker Color</b> R Red Y Yellow G Green B Blue W White K Black	Discount <b>BE</b> Schedule Qty.: <b>25</b> pieces/listing Unclass.  Five piece minimum order quantity for buttons  AML56-N covers have a colored lenticular lens window which extends over the neon lamp.  Example: <b>AML56-N10RY</b> Full rocker; with transmitted color, no legend; yellow rocker and red lens  NOTE: AML56 has a \$6.00 net each recurring set up charge per legend. A one-time charge of \$70.00 applies to establish a new graphic legend.

## AML56 Rocker switch operators

### AML56 ORDER GUIDE (for LED display)

AML56-T	10	R      B		
<b>Rocker Operator Type</b>  <b>AML56-E</b> 1/2 rocker* (for 1 LED)   <b>AML56-T</b> Two-piece rocker (for one LED)   <b>AML56-H</b> Two-piece rocker (for two LEDs)	<b>Display/Legend Type (see note)</b> <b>Transmitted Color</b> 10 No legend 20 With legend	<b>Rocker Color</b> 1/2 rocker or LED side of two-piece rockers      Other side of two-piece rockers		Discount <b>BE</b> Schedule Qty.: <b>25</b> pieces/listing Unclass.  Five piece minimum order quantity for button.  Example: <b>AML56-T10RB</b> Two-piece rocker; with LED window in one side, transmitted color, no legend; red (LED side) and blue (non-LED side).
		R Red Y Yellow G Green B Blue W White K Black L Gray	R Red Y Yellow G Green B Blue W White K Black L Gray	

# Honeywell Sensing and Control AML/MML Selection Guide

## AML59 Solid state LED annunciators\*

### AML59 ORDER GUIDE

Cap Style	Cap Color	Legend Type*	Filter color		
			Full	Split Screen	
<b>AML59-R</b> Full screen	<b>K</b> Black	<b>10</b> No legend	<b>R</b> Red	<b>R</b> Red	<b>R</b> Red
<b>AML59-S</b> Split screen			<b>Y</b> Yellow	<b>Y</b> Yellow	<b>Y</b> Yellow
		<b>20*</b> Negative Film Legend	<b>G</b> Green	<b>G</b> Green	<b>G</b> Green
		<b>21*</b> Positive Film Legend			

Discount **BE**  
Schedule Qty.: **25** pieces/listing  
Unclass.

Five piece minimum order quantity for buttons

Examples: **AML59-RK10R**  
Full-screen style, black cap, no legend and red filter

**AML59-SK20RY**  
Split-screen style, black cap, negative film legend, red and yellow color filters

\*AML59 has a \$6.00 net each recurring set-up charge per legend. A one-time charge of \$70.00 applies to establish a new graphic legend.

\* **NOTE:** Contact Customer Service for minimum quantity required to establish or reinstate a catalog listing

## AML61 Mounting Hardware\*

Discount **BE**  
Schedule Qty.: **25** pieces/listing  
Unclass.

### AML61 MOUNTING HARDWARE ORDER GUIDE (for standard strip-mount assemblies)

AML61B	A	5	A	
Type	Mounting Bracket Orientation	Number of cans	Mounting Bracket Location	
<b>Square cans</b>	<b>A</b> 	<b>Square Hous.</b>		
<b>AML61B</b> Plain finish	<b>E</b> 	1		
<b>AML61J</b> (Black finish)		2		
<b>Rect. cans</b>	<b>B</b> 	3		
		4		
		5		
		6		
		7		
		8		
	<b>C</b> 	<b>D</b> 	<b>Rect. Hous.</b>	
			1	
			2	
			3	
			4	
			5	
	6			
	7			
	8			
	9			
	10			
	11			
	12			

\*To order one rectangular can with mounting brackets on short sides, specify AML61EB1\_\_ or AML61KB1\_\_.

Example: **AML61EC5A**

Five rectangular cans, plain finish (unpainted), long sides abutting; type **A** mounting brackets on long sides, located flush with switch or indicator bezel. (Type **T** bracket brings top of annunciator bezel flush with top of .160 in./4.1 mm panel).

\* **NOTE:** Contact Customer Service for minimum quantity required to establish or reinstate a catalog listing

# Honeywell Sensing and Control AML/MML Selection Guide

## AML71/75/76/78/79 Accessories \*

### AML71 BARRIER ORDER GUIDE

(Barriers shown in order guide are black)

Barrier Length	Type	Catalog Listing
Short (For use with square devices and short-side of rectangular devices)	Center	AML71SCB
	End	AML71SEB
Long (For use with long side of rectangular devices)	Center	AML71LCB
	End	AML71LEB

Discount **BE**  
Schedule Qty.: 25 pieces/listing  
Unclass.

Notes: Not for use with AML61 mounting hardware  
Not for use with AML41J, K, or L lens-type indicators; or AML45 annunciators

### AML75 PANEL SEAL ORDER GUIDE

Description	For use with:		
	Square 19" high pushbuttons	Rectangular 19" high pushbuttons	Rockers
Base & Seal	AML75ABC	AML75BBC	AML75RBC

Discount **BE**  
Schedule Qty.: 25 pieces/listing  
Unclass.

Notes: Multiple units should not be mounted in a single slot, since this would create an unsealed space between each unit. AML75 seals are not for use with barriers, full-guard bezels, AML61 mounting hardware, AML45 annunciators, or AML41J, K or L lens-type indicators.

### AML76 SWITCH ORDER GUIDE

Guard Type	Catalog Listing
Square	AML76C10T01P
Rectangular	AML76F10T01P

### AML78 PANEL PLUGS

Description	Catalog Listing
Square	AML78CB
Rectangular	AML78FB

### DUMMY HOUSING ORDER GUIDE

Description	Catalog Listing
Rectangular (pushbutton)	AML78F100
Rectangular (lens indicator)	AML78J100

\* Order AML51 buttons/lenses for use with dummy housings

### AML79 CONNECTOR BLOCK

This connector block can be used with square 1 and 2 pole AML21 and AML22 switches with .110 x .020 terminals to enable plug-in wiring.

#### AML79CC

\* **NOTE:** Contact Customer Service for minimum quantity required to establish or reinstate a catalog listing

# Honeywell Sensing and Control AML/MML Selection Guide

## AML91/92 Lamps/LEDs\*\*

### AML91 LAMP ORDER GUIDE

Lamp Type	Industry Lamp No.	Voltage	Catalog Listing
Incandescent T-1-3/4 wedge base	86	6.3	AML91LA86
	73	14.0	AML91LA73
	85	28.0	AML91LA85

Discount **BE**  
Schedule Qty.: **25** pieces/listing  
Unclass.

Ten piece minimum order quantity for lamps and LEDs.

### AML92 LED ORDER Guide

LED Color	Quad Chip	Six Chip
Red	AML92ERY	AML92ERL
Green	AML92EGY	AML92EGL
Yellow	AML92EYY	AML92EYL
White	-	AML92EWL*

\* For use with white or yellow buttons

\*\* **NOTE:** Contact Customer Service for minimum quantity required to establish or reinstate a catalog listing

# Honeywell Sensing and Control AML/MML Selection Guide

## MML11 Solid state pushbutton switches\*

Example: **MML11KK3AAK**

Solid state pushbutton housing (black), no bezel; PWB terminals; momentary action; 5 VDC, current sinking output, black plunger

Example: **MML11KK3AAKRSDR**

As above, except furnished with black bezel; mounting clips (long sides); red LED, and red lens installed

Discount **BE**

Schedule Qty.: **25** pieces/listing  
Unclass.

### MML11 LED, INCANDESCENT, OR NON-LIGHTED DISPLAY ORDER GUIDE

Catalog listing codes for switch,  
less assembled display options

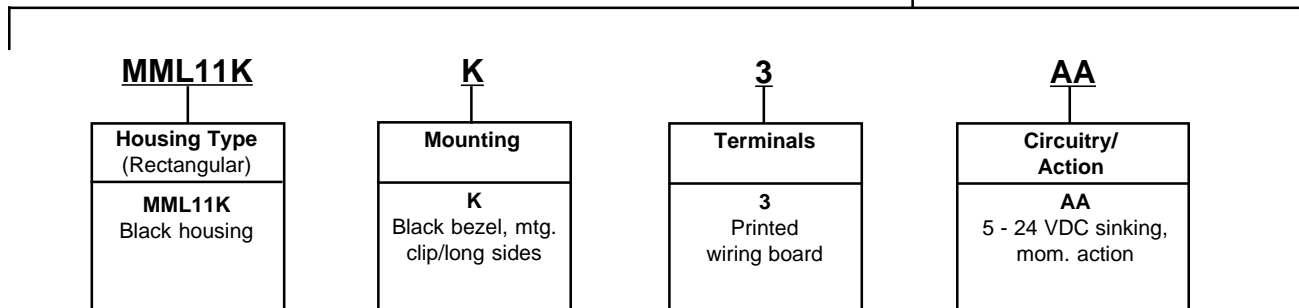

## MML21 Electronic control pushbutton switches\*

Example: **MML21KK3AAK**

Electronic control pushbutton switch; rectangular housing (black); bezel (black); mounting clips on long sides, PWB terminals; 1-pole momentary action, silver contacts, black plunger

Example: **MML21KK3AAKRSDR**

As above, except furnished with red LED and red lens installed

Discount **BE**

Schedule Qty.: **25** pieces/listing  
Unclass.

### MML21 (RECTANGULAR) LED, INCANDESCENT, OR NON-LIGHTED DISPLAY ORDER GUIDE

Catalog listing codes for switch,  
less assembled display options



\* Specify **AC** or **BC** for use with **encoded** umbrella style buttons.

\* **NOTE:** Contact Customer Service for minimum quantity required to establish or reinstate a catalog listing

# Honeywell Sensing and Control AML/MML Selection Guide

Order MML11 display options assembled to switch by adding codes below.

<b>K</b>	<b>RS</b>	<b>DR</b>	<u>Leave this space blank, if legend not desired</u>
<b>Plunger</b>	<b>LED</b> (Stanley Type)	<b>Lens</b>	<b>Legend</b>
<b>K</b> Black	<b>XX</b> No LED <b>RS</b> Red* <b>YS</b> Yellow* <b>GS</b> Green*  <small>* Permanently installed.</small>	<b>For LED Display</b> <b>DR</b> Red <b>DY</b> Yellow <b>DG</b> Green  <b>For incandescent or non-lighted display</b> <b>LR</b> Red <b>LY</b> Yellow <b>LG</b> Green <b>LW</b> White <b>LK</b> Black	<b>20</b> with legend  A \$6.00 recurring set up charge per legend. A one-time charge of \$70.00 applies to establish a new graphic legend.

Order MML21 display options assembled to switch by adding codes below.

<b>K</b>	<b>RS</b>	<b>DR</b>	<u>Leave this space blank, if legend not desired</u>
<b>Std.Plunger (w/o lens)</b>	<b>LED</b> (Stanley Type)	<b>Lens</b>	<b>Legend</b>
<b>K</b> Black  <b>W</b> White	<b>XX</b> No LED <b>RS</b> Red* <b>YS</b> Yellow* <b>GS</b> Green*  <small>* Permanently installed.</small>	<b>XX</b> No lens* <b>For LED Display</b> <b>DR</b> Red <b>DY</b> Yellow <b>DG</b> Green  <b>For incandescent or non-lighted display</b> <b>LR</b> Red <b>LY</b> Yellow <b>LG</b> Green <b>LW</b> White <b>LK</b> Black  <small>* Enter XX when 1-piece plunger/lens is specified and legending is required.</small>	<b>20</b> with legend  A \$6.00 recurring set up charge per legend. A one-time charge of \$70.00 applies to establish a new graphic legend.
<b>1-piece Plunger/Lens Cap Buttons</b>			
<b>For LED Display</b> <b>H</b> Red <b>L</b> Yellow <b>N</b> Green  <b>For incandescent or non-lighted display</b> <b>R</b> Red <b>Y</b> Yellow <b>G</b> Green <b>Z</b> Black			

# Honeywell Sensing and Control AML/MML Selection Guide

## MML21 Electronic control pushbutton switches\*

Example: **MML21HR3AAKXXDR**

Electronic control pushbutton switch; square housing (black); bezel (black) and mounting clips; PWB terminals; 1-pole momentary action, silver contacts; black plunger, with red lens installed.

Discount **BE**

Schedule Qty.: **25** pieces/listing

Unclass.

### MML21 (SQUARE) LED, INCANDESCENT, OR NON-LIGHTED DISPLAY ORDER GUIDE

Catalog listing codes for switch,  
less assembled display options



\* **NOTE:** Contact Customer Service for minimum quantity required to establish or reinstate a catalog listing



# Honeywell Sensing and Control AML/MML Selection Guide

Order MML21 display options assembled to switch by adding codes below.

<b>K</b>		<b>XX</b>	<b>DR</b>	<u>Leave this space blank, if legend not desired</u>
Std.Plunger (w/o lens)	1-piece Plunger/Lens Cap Buttons	LED	Lens	Legend
<b>K</b> Black	<b>For LED Display</b> <b>H</b> Red <b>L</b> Yellow <b>N</b> Green  <b>For incandescent or non-lighted display</b> <b>R</b> Red <b>Y</b> Yellow <b>G</b> Green <b>Z</b> Black	<b>XX</b> No LED  LEDs are not permanently installed in square housings by Honeywell Sensing and Control.  Use the MML93L recep- tacle.	<b>XX</b> No lens <b>For LED Display</b> <b>DR</b> Red <b>DY</b> Yellow <b>DG</b> Green  <b>For incandescent or non-lighted display</b> <b>LR</b> Red <b>LY</b> Yellow <b>LG</b> Green <b>LW</b> White <b>LK</b> Black	<b>20</b> with legend  A \$6.00 recurring set up charge per legend. A one-time charge of \$70.00 applies to establish a new graphic legend.

# Honeywell Sensing and Control AML/MML Selection Guide

## MML24 Electronic control rocker switches\*\*

Example: **MML24KA3AA01HDRXX**

Electronic control rocker switch with black housing, printed wiring board terminals; one-pole, silver contacts; 2-position, maintained action; one-circuit ON in each position; black rocker, red lens for LED display in Side 1 and no lens in Side 2.

Discount **BE**

Schedule Qty.: **25** pieces/listing

Unclass.

### MML24 LED, INCANDESCENT, OR NON-LIGHTED DISPLAY ORDER GUIDE

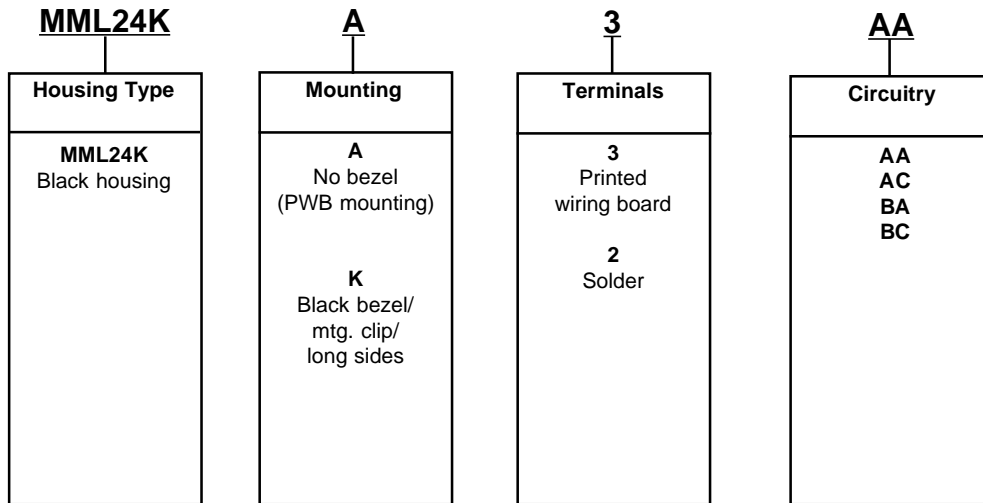

\* Lighted switches with solder terminals require MML93R receptacle to install lamps or LEDs.

\*\* **NOTE:** Contact Customer Service for minimum quantity required to establish or reinstate a catalog listing

# Honeywell Sensing and Control AML/MML Selection Guide

<b>01</b>		<b>H</b>		<b>DRXX</b>				<u>Leave this space blank, if legend not desired</u>
<b>Action</b>		<b>Rocker</b>		<b>Lens (Side 1)</b>		<b>Lens (Side 2)</b>		<b>Legend</b>
No Charge		<b>B</b> Black rocker  <b>H</b> Black rocker, one lens*  <b>F</b> White rocker, one lens*		<b>XX</b> None  LED display: <b>DR</b> Red <b>LR</b> Red <b>DY</b> Yellow <b>LY</b> Yellow <b>DG</b> Green <b>LG</b> Green <b>LW</b> White		<b>XX</b> None  LED display: <b>DR</b> Red <b>LR</b> Red <b>DY</b> Yellow <b>LY</b> Yellow <b>DG</b> Green <b>LG</b> Green <b>LW</b> White		<b>20</b> with legend  A \$6.00 recurring set up charge per legend. A one-time charge of \$70.00 applies to establish a new graphic legend.

\* Lighted switches with solder terminals require MML93R receptacle to install lamps or LEDs.

# Honeywell Sensing and Control AML/MML Selection Guide

## MML46 Indicators/flush mount\*\*

Example: **MML46KA3**

Indicator housing, rectangular (black); no bezel; support terminals

Example: **MML46KA3RSXXDR20**

As above, except furnished with red LED and red lens, with legend

Discount **BE**

Schedule Qty.: **25** pieces/listing  
Unclass.

### MML46 LED OR INCANDESCENT DISPLAY ORDER GUIDE

<b>MML46K</b>	<b>A</b>		<b>3</b>
Housing Type	Mounting Rectangular	Mounting Square	Support Posts
<p><b>MML46K Rectangular</b> (1 or 2 LEDs or incand. lamps) Black housing</p> <p><b>MML46H Square</b> (1 LED or incand. lamp) Black housing</p>	<p><b>A</b> No bezel (PWB mounting)</p> <p><b>K</b> Black bezel, mtg. clip/ long sides</p>	<p><b>A</b> No bezel (PWB mounting)</p> <p><b>R</b> Black bezel, mtg. clip/ long sides</p>	<p><b>3</b> PWB</p> <p><b>2</b> Solder** No charge</p> <p><b>0</b> None (for snap-in and strip/matrix mount) No charge</p>

\* LEDs are not permanently installed in square housings by Honeywell Sensing and Control.

\*\* Rectangular housings only

\*\* **NOTE:** Contact Customer Service for minimum quantity required to establish or reinstate a catalog listing

## MML51 Button lenses/incandescent or non-lighted display\*\*

### MML51 ORDER GUIDE

<b>MML51E</b>	<b>20</b>	<b>R</b>
Lens Type	Display/Legend Type	Color
<p><b>Rectangular MML51E</b> Switch lens</p> <p><b>MML51G*</b> Indicator lens</p>	<p><b>10</b> No legend</p> <p><b>20</b> With Legend</p> <p>A \$6.00 recurring set up charge per legend. A one-time charge of \$70.00 applies to establish a new graphic legend.</p>	<p><b>R</b> Red</p> <p><b>Y</b> Yellow</p> <p><b>G</b> Green</p> <p><b>W</b> White</p> <p><b>K</b> Black (opaque)</p>

Discount **BE**  
Schedule Qty.: **25** pieces/listing  
Unclass.

Five piece minimum order quantity for buttons

Example:  
**MML51E20R**  
Incandescent or non-lighted display switch lens; red transmitted color, with legend. Unclassified.

\*\* **NOTE:** Contact Customer Service for minimum quantity required to establish or reinstate a catalog listing

\* Use MML51E with MML41 rectangular pushbutton style indicators

# Honeywell Sensing and Control AML/MML Selection Guide

Order MML46 display options assembled to indicator by adding codes below.

**Leave this space blank,  
if legend not desired**

<b>RSXX</b>	<b>DR</b>	<b>20</b>		
<b>LED</b> (Stanley type)	<b>Lens</b>	<b>Legend</b>		
Available in rectangular housings only <b>XX</b> No LED  One LED*            Two LEDs* <b>RSXX</b> Red <b>RSRS</b> Red <b>YSXX</b> Yellow <b>YSYS</b> Yellow <b>GSXX</b> Green <b>GSGS</b> Green  * Permanently installed	<table border="1" style="width: 100%;"> <tr> <td style="width: 50%;">                             For LED display   <b>DR</b> Red  <b>DY</b> Yellow  <b>DG</b> Green                         </td> <td style="width: 50%;">                             For incandescent or non-lighted display   <b>LR</b> Red  <b>LY</b> Yellow  <b>LG</b> Green  <b>LW</b> White  <b>LK</b> Black                         </td> </tr> </table>	For LED display  <b>DR</b> Red <b>DY</b> Yellow <b>DG</b> Green	For incandescent or non-lighted display  <b>LR</b> Red <b>LY</b> Yellow <b>LG</b> Green <b>LW</b> White <b>LK</b> Black	<b>20</b> with legend  A \$6.00 recurring set up charge per legend. A one-time charge of \$70.00 applies to establish a new graphic legend.
For LED display  <b>DR</b> Red <b>DY</b> Yellow <b>DG</b> Green	For incandescent or non-lighted display  <b>LR</b> Red <b>LY</b> Yellow <b>LG</b> Green <b>LW</b> White <b>LK</b> Black			

Since square housings accept only one LED, only a two-character LED code is necessary.  
 For example:  
 MML46HR0XXDY or  
 MML46HR0RSDY

\* When ordering incandescent or non-lighted display, LED field must be XXXX.

## MML52 Button lenses/LED\*\*

### MML52 ORDER GUIDE

<b>MML52G</b>	<b>10</b>	<b>Y</b>	
<b>Lens Type</b>	<b>Display/Legend Type</b>	<b>Color/Illumination</b>	
<b>Rectangular</b> <b>MML52E</b> Switch lens LED display  <b>MML52G*</b> Indicator lens	<b>Trans. Color</b> <b>10</b> No legend  <b>20</b> With Legend  A \$6.00 recurring set up charge per legend. A one-time charge of \$70.00 applies to establish a new graphic legend.	<b>LED Display</b> <b>R</b> Red  <b>Y</b> Yellow  <b>G</b> Green  <b>C</b> Clear	Discount <b>BE</b> Schedule Qty.: <b>25</b> pieces/listing Unclass.  Five piece minimum order quantity for buttons  Example: <b>MML52G10Y</b> LED display indicator lens; yellow transmitted color, no legend. Unclassified.  <b>** NOTE:</b> Contact Customer Service for minimum quantity required to establish or reinstate a catalog listing

\* Use MML52E with MML41 rectangular pushbutton style indicators

# Honeywell Sensing and Control AML/MML Selection Guide

## MML72 Bezels/mounting clips\*

Discount **BE**  
 Schedule Qty.: 25 pieces/listing  
 Unclass.

Ten piece minimum order quantity

Example:  
**MML72EEK**  
 Black switch bezel, mounting clips on long sides.

\* **NOTE:** Contact Customer Service for minimum quantity required to establish or reinstate a catalog listing

## MML92 LEDs\*\*\*

Discount **BE**  
 Schedule Qty.: 25 pieces/listing  
 Unclass.

### MML92 ORDER GUIDE

LEDs should be the same color as the lenses they illuminate. They are packed 10 per listing, including stand-off spacers for use when solder terminating to a printed wiring board.

LED Type	Use to Illuminate	Catalog Listing	LED Color	Forward Characteristics Typ. @ 20mA	Max.	LED Manufacturers' Part Numbers
T-1-3/4	Rectangular button lens	MML92ERS	Red	1.7V	<b>Stanley:</b> 2.0V 2.5V 2.5V	ESBR5633
		MML92EGS	Green	2.1V		ESBG5633
		MML92EYS	Yellow	2.1V		ESAY5633
T-1	Square button lens and MML24 rocker lens**	MML92HGS	Green	2.1V	<b>Stanley:</b> 2.5V	ESPY3901
		MML92HRH	Red	2.2V*		<b>Hewlett Packard:</b> 3.0V 3.0V
		MML92HGH	Green	2.3V*	HLMP-1540	

Long lead: Anode (+), Short lead: Cathode (-).

\* @ 25 mA.

\*\* Also rectangular button lens, when used with MML93J solder terminal receptacle.

\*\*\* **NOTE:** Contact Customer Service for minimum quantity required to establish or reinstate a catalog listing

# Honeywell Sensing and Control AML/MML Selection Guide

## MML93 LED/Incandescent lamp receptacles\* Discount BE Schedule Qty.: 25 pieces/listing Unclass.

### MML93 RECEPTACLE ORDER GUIDE

These receptacles do not include LEDs or lamps.

Receptacle Type	Catalog Listing	Mates With	Use to Illuminate
Printed Wiring Board	MML93K	T-1 3/4 LED	Rectangular button lens or umbrella button lens
	MML93G	T-1 LED or bi-pin lamp	Square button lens or MML24 rocker lens
Solder Terminal	MML93J	T-1 LED or bi-pin lamp	Rectangular button lens
Solder	MML93L	T-1 LED or unbased T-1 lamp	Square button lens
	MML93R	T-1 LED or unbased T-1 lamp	MML24 rocker lens

\* **NOTE:** Contact Customer Service for minimum quantity required to establish or reinstate a catalog listing

Компания «Океан Электроники» предлагает заключение долгосрочных отношений при поставках импортных электронных компонентов на взаимовыгодных условиях!

Наши преимущества:

- Поставка оригинальных импортных электронных компонентов напрямую с производств Америки, Европы и Азии, а так же с крупнейших складов мира;
- Широкая линейка поставок активных и пассивных импортных электронных компонентов (более 30 млн. наименований);
- Поставка сложных, дефицитных, либо снятых с производства позиций;
- Оперативные сроки поставки под заказ (от 5 рабочих дней);
- Экспресс доставка в любую точку России;
- Помощь Конструкторского Отдела и консультации квалифицированных инженеров;
- Техническая поддержка проекта, помощь в подборе аналогов, поставка прототипов;
- Поставка электронных компонентов под контролем ВП;
- Система менеджмента качества сертифицирована по Международному стандарту ISO 9001;
- При необходимости вся продукция военного и аэрокосмического назначения проходит испытания и сертификацию в лаборатории (по согласованию с заказчиком);
- Поставка специализированных компонентов военного и аэрокосмического уровня качества (Xilinx, Altera, Analog Devices, Intersil, Interpoint, Microsemi, Actel, Aeroflex, Peregrine, VPT, Syfer, Eurofarad, Texas Instruments, MS Kennedy, Miteq, Cobham, E2V, MA-COM, Hittite, Mini-Circuits, General Dynamics и др.);

Компания «Океан Электроники» является официальным дистрибьютором и эксклюзивным представителем в России одного из крупнейших производителей разъемов военного и аэрокосмического назначения «JONHON», а так же официальным дистрибьютором и эксклюзивным представителем в России производителя высокотехнологичных и надежных решений для передачи СВЧ сигналов «FORSTAR».



## JONHON

«JONHON» (основан в 1970 г.)

Разъемы специального, военного и аэрокосмического назначения:

(Применяются в военной, авиационной, аэрокосмической, морской, железнодорожной, горно- и нефтедобывающей отраслях промышленности)

«FORSTAR» (основан в 1998 г.)

ВЧ соединители, коаксиальные кабели, кабельные сборки и микроволновые компоненты:

(Применяются в телекоммуникациях гражданского и специального назначения, в средствах связи, РЛС, а так же военной, авиационной и аэрокосмической отраслях промышленности).



Телефон: 8 (812) 309-75-97 (многоканальный)

Факс: 8 (812) 320-03-32

Электронная почта: [ocean@oceanchips.ru](mailto:ocean@oceanchips.ru)

Web: <http://oceanchips.ru/>

Адрес: 198099, г. Санкт-Петербург, ул. Калинина, д. 2, корп. 4, лит. А