

Features

- High Gain: 22 dB @ 30 GHz
- P1dB: 34.5 dBm
- P_{SAT}: 36 dBm
- IM3 Level: -27 dBc @ P_{OUT} 29 dBm/tone
- Power Added Efficiency: 23% @ P_{SAT}
- Lead-Free 5 mm 32-lead AQFN Plastic Package
- RoHS* Compliant

Description

The MAAP-011139 is a 4-stage, 4 W power amplifier assembled in a lead-free 5 mm 32-lead AQFN plastic package. This power amplifier operates from 28.5 to 31 GHz and provides 22 dB of linear gain, 4 W saturated output power, and 23% efficiency while biased at 6 V.

The MAAP-011139 is a power amplifier ideally suited for VSAT communications.

This product is fabricated using a GaAs pHEMT process which features full passivation for enhanced reliability.

Ordering Information^{1,2}

Part Number	Package
MAAP-011139-TR0500	500 piece reel
MAAP-011139-SMB	Sample Board

1. Reference Application Note M513 for reel size information.
2. All sample boards include 3 loose parts.

*Restrictions on Hazardous Substances, European Union Directive 2011/65/EU.

Functional Schematic

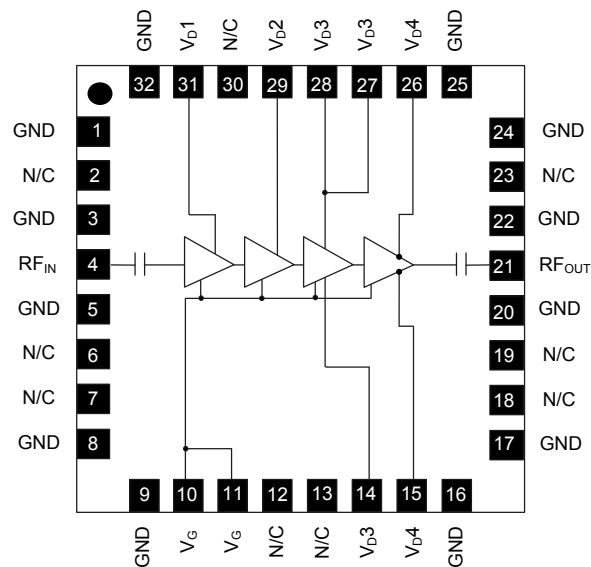

Pin Configuration³

Pin No.	Function	Pin No.	Function
1	Ground	18, 19	No Connection
2	No Connection	20	Ground
3	Ground	21	RF Output
4	RF Input	22	Ground
5	Ground	23	No Connection
6, 7	No Connection	24, 25	Ground
8, 9	Ground	26	Drain Voltage 4
10	Gate Voltage	27	Drain Voltage 3
11	Gate Voltage	28	Drain Voltage 3
12, 13	No Connection	29	Drain Voltage 2
14	Drain Voltage 3	30	No Connection
15	Drain Voltage 4	31	Drain Voltage 1
16, 17	Ground	32	Ground
		Paddle ⁴	Ground

3. MACOM recommends connecting unused package pins to ground.
4. The exposed pad centered on the package bottom must be connected to RF, DC and thermal ground.

Electrical Specifications: Freq. = 30 GHz, T_A = +25°C, V_D = 6 V, Z₀ = 50 Ω

Parameter	Test Conditions	Units	Min.	Typ.	Max.
Gain	P _{IN} = 0 dBm	dB	19	22	—
P _{OUT}	P _{IN} = +17 dBm	dBm	34.5	36.0	—
IM3 Level	P _{OUT} = +29 dBm / tone	dBc	—	-27	—
Power Added Efficiency	P _{SAT} (P _{IN} = +17 dBm)	%	—	23	—
Input Return Loss	P _{IN} = -20 dBm	dB	—	10	—
Output Return Loss	P _{IN} = -20 dBm	dB	—	10	—
Quiescent Current	I _{DQ} (see bias conditions, page 5)	mA	—	2000	—
Current	P _{SAT} (P _{IN} = +17 dBm)	mA	—	2700	—

Maximum Operating Conditions

Parameter	Maximum
Input Power	+17 dBm
Junction Temperature ^{5,6}	+160°C
Operating Temperature	-40°C to +85°C

5. Operating at nominal conditions with junction temperature ≤ +160°C will ensure MTTF > 1 x 10⁶ hours.
6. Junction Temperature (T_J) = T_C + Θ_{JC} * [(V * I) - (P_{OUT} - P_{IN})].
Typical thermal resistance (Θ_{JC}) = 4.4 °C/W.
 - a) For T_C = +25°C,
T_J = +79°C @ 6 V, 2.7 A, P_{OUT} = 36 dBm, P_{IN} = 17 dBm
 - b) For T_C = +85°C,
T_J = +143°C @ 6 V, 2.7 A, P_{OUT} = 35.1 dBm, P_{IN} = 17 dBm

Absolute Maximum Ratings^{7,8}

Parameter	Absolute Maximum
Input Power	+23 dBm
Drain Voltage	+6.5 V
Gate Voltage	-3 to 0 V
Junction Temperature ⁹	+175°C
Storage Temperature	-65°C to +125°C

7. Exceeding any one or combination of these limits may cause permanent damage to this device.
8. MACOM does not recommend sustained operation near these survivability limits.
9. Junction Temperature directly effects device MTTF. Junction temperature should be kept as low as possible to maximize lifetime.

Sample Board Layout

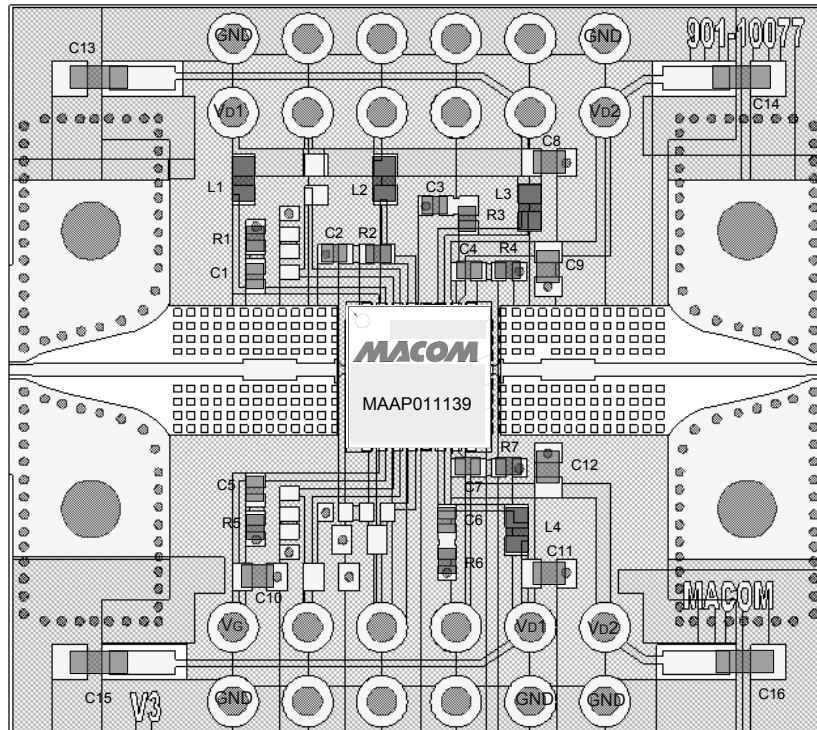

Application Schematic

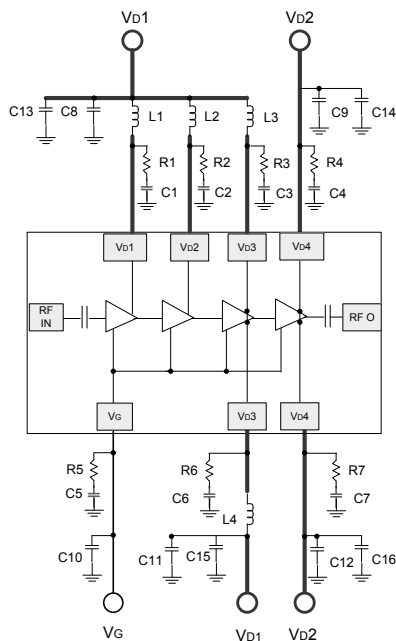

Parts List

Part	Value	Case Style
C1 - C7	0.01 μ F	0402
C8 - C12	1 μ F	0603
C13 - C16	10 μ F	0805
R1 - R7	10 Ω	0402
L1 - L4 (Chip Ferrite Bead)	BLM18HE601SN1D	0603

Sample Board Material Specifications

Top Layer: 1/2 oz Copper Cladding, 0.017 mm thickness
Dielectric Layer: Rogers RO4003C 0.203 mm thickness
Bottom Layer: 1/2 oz Copper Cladding, 0.017 mm thickness
Finished overall thickness: 0.238 mm

Sample Board Layout: RF input and output port pre-matching circuit patterns are designed to compensate for packaging effects. Input and output match patterns are identical.

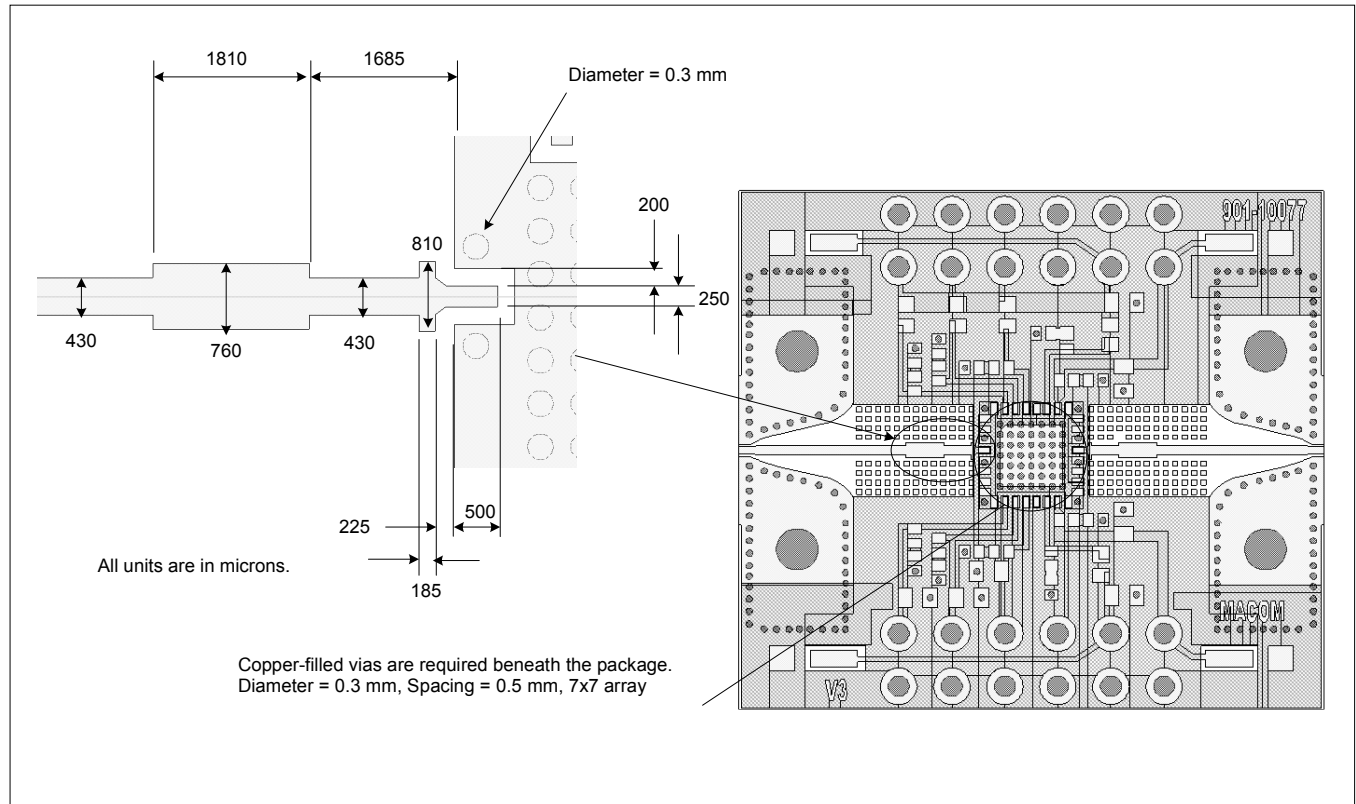

Application Information

The MAAP-011139 is designed to be easy to use yet high performance. The ultra small size and simple bias allow easy placement on system board. RF input and output ports are DC de-coupled internally.

Biasing conditions

Recommended biasing conditions are $V_D = 6\text{ V}$, $I_{DQ} = 2000\text{ mA}$ (controlled with V_G). The drain bias voltage range is 3 to 6 V, and the quiescent drain current biasing range is 1500 to 2500 mA.

V_G pins 10 and 11 are connected internally; choose either pin for layout convenience. Muting can be accomplished by setting the V_G to the pinched off voltage ($V_G = -2\text{ V}$).

V_D bias must be applied to V_{D1} , V_{D2} , V_{D3} , and V_{D4} pins.

V_{D3} pins 14 and either pin 27 or 28 are required for current symmetry. Pins 27 and 28 are connected internally; choose either pin for layout convenience.

Both V_{D4} pins 15 and 26 are required for current symmetry.

Operating the MAAP-011139

Turn-on

1. Apply V_G (-1.5 V).
2. Apply V_D (6.0 V typical).
3. Set I_{DQ} by adjusting V_G more positive (typically $V_G \sim -0.9\text{ V}$ for $I_{DQ} = 2000\text{ mA}$).
4. Apply RF_{IN} signal.

Turn-off

1. Remove RF_{IN} signal.
2. Decrease V_G to -1.5 V.
3. Decrease V_D to 0 V.

Handling Procedures

Please observe the following precautions to avoid damage:

Static Sensitivity

These electronic devices are sensitive to electrostatic discharge (ESD) and can be damaged by static electricity. Proper ESD control techniques should be used when handling these HBM Class 1A devices.

Typical Performance Curves

Small Signal Gain vs. Frequency over Temperature

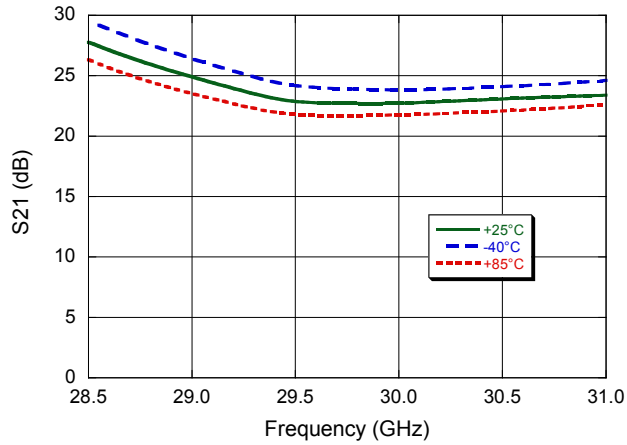

Small Signal Gain vs. Frequency over Bias Voltage

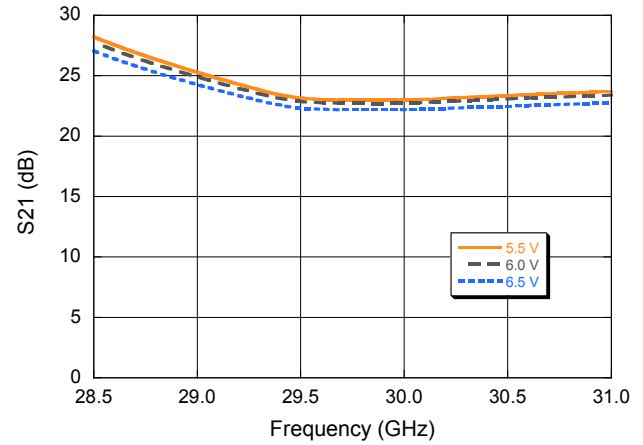

Input Return Loss vs. Frequency over Temperature

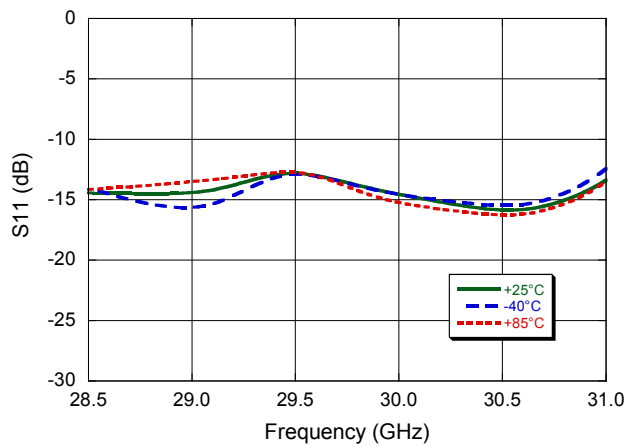

Input Return Loss vs. Frequency over Bias Voltage

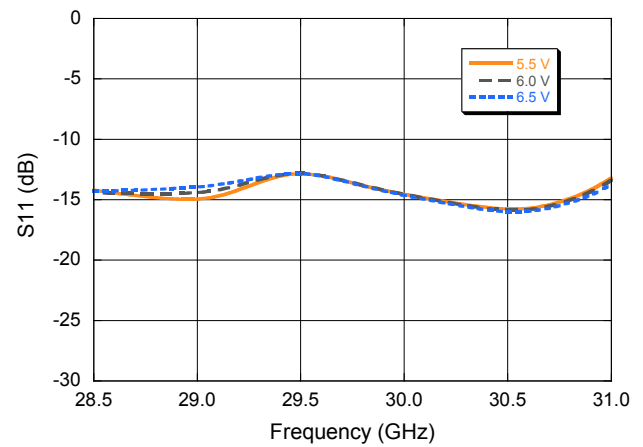

Output Return Loss vs. Frequency over Temperature

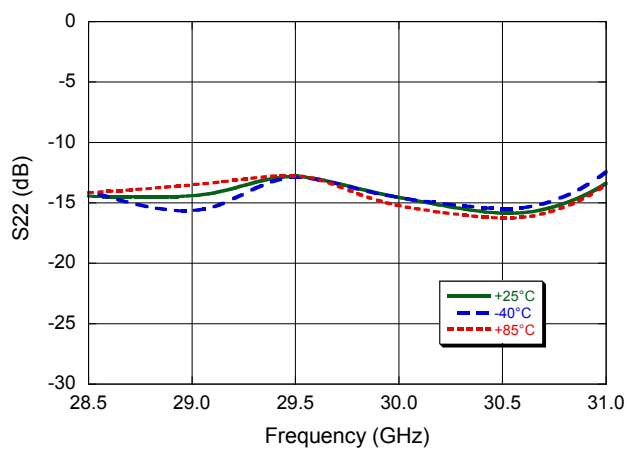

Output Return Loss vs. Frequency over Bias Voltage

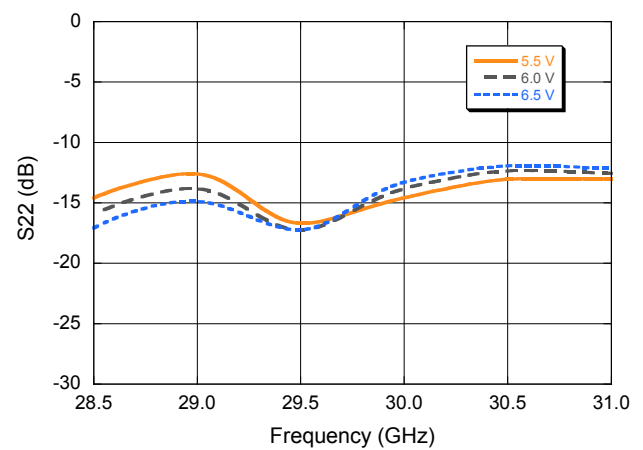

Typical Performance Curves

P_{SAT} vs. Frequency over Temperature

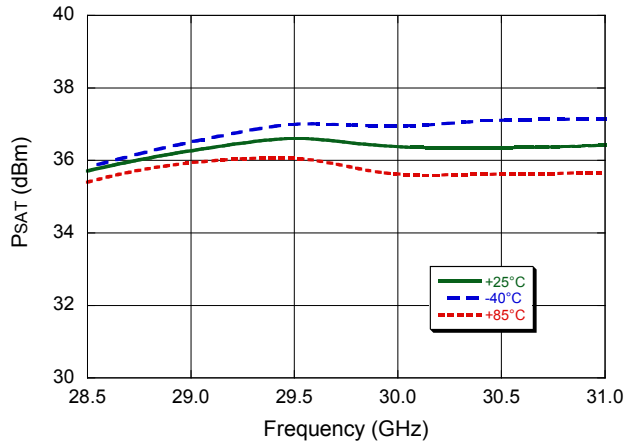

P_{SAT} vs. Frequency over Bias Voltage

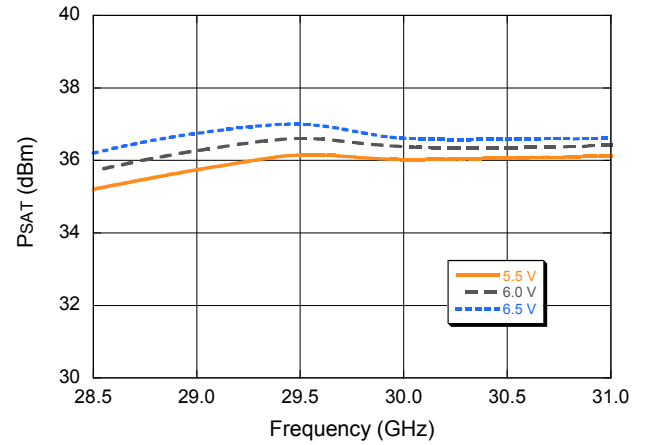

P1dB vs. Frequency over Temperature

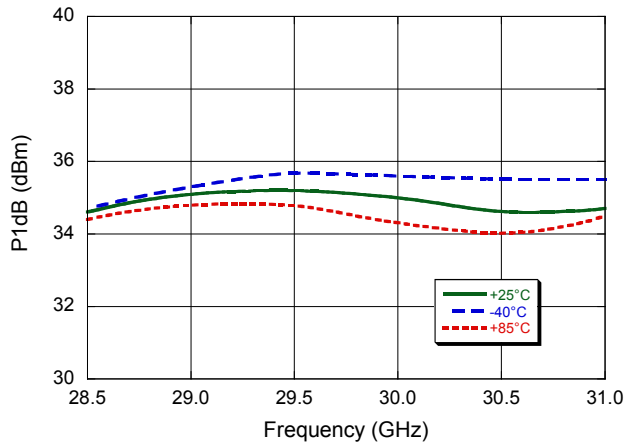

P1dB vs. Frequency over Bias Voltage

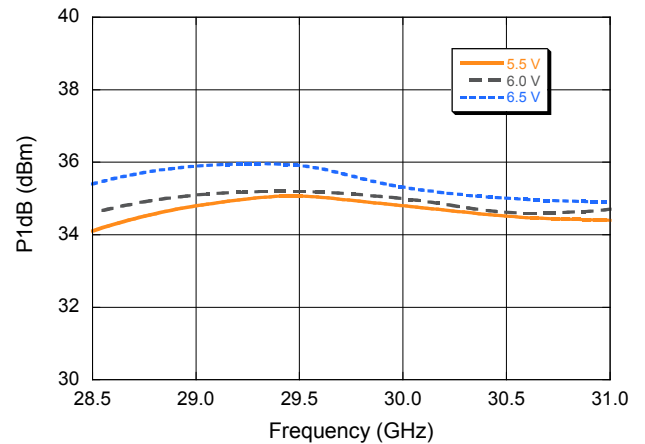

Typical Performance Curves

Output IP3 over Temperature ($P_{out}=29$ dBm/tone)

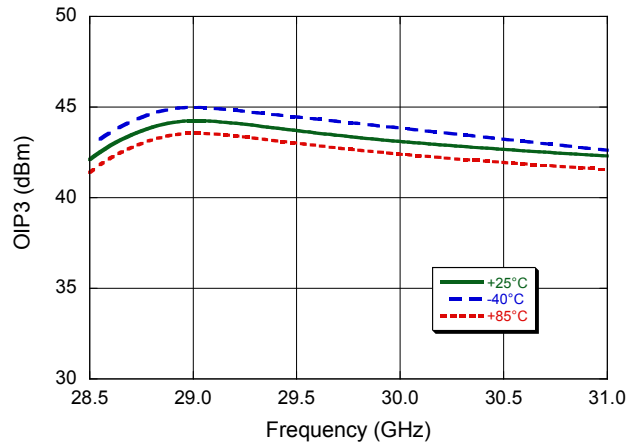

Output IP3 over Bias Voltage ($P_{out}=29$ dBm/Tone)

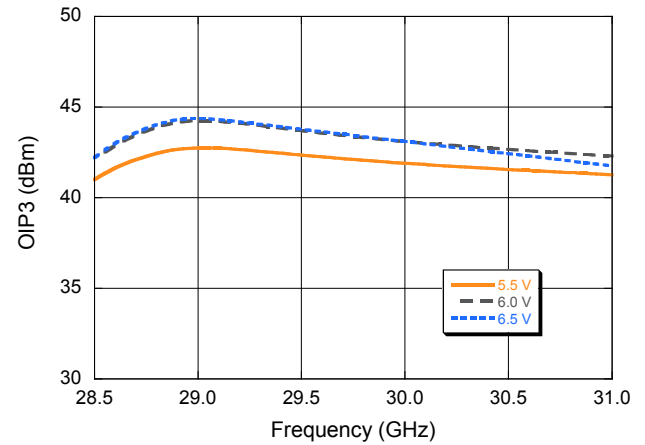

IM3 over Temperature ($P_{out}=29$ dBm/tone)

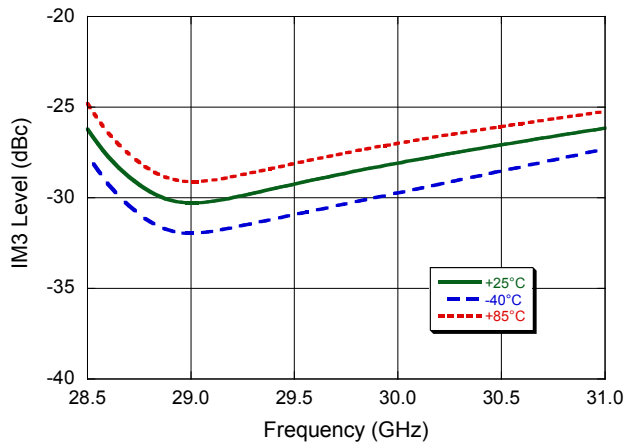

IM3 over Bias Voltage ($P_{out}=29$ dBm/tone)

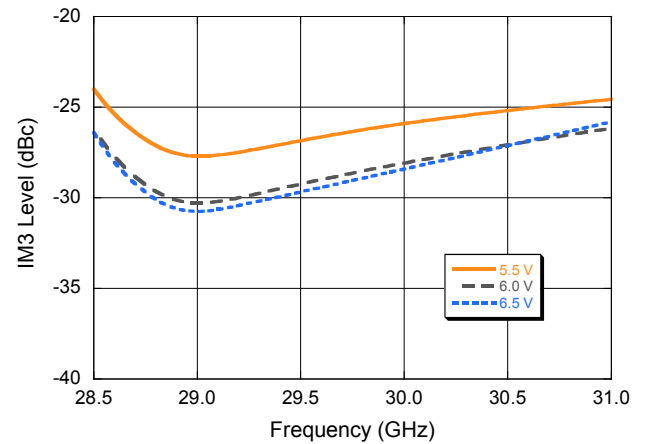

Typical Performance Curves

P_{1dB}, P_{SAT} vs. Frequency

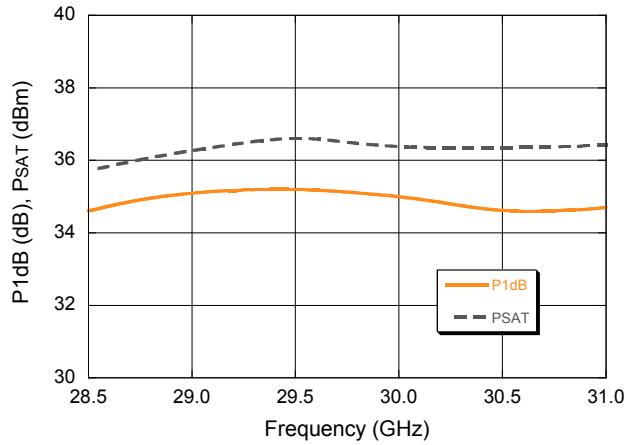

PAE, Gain vs. Frequency

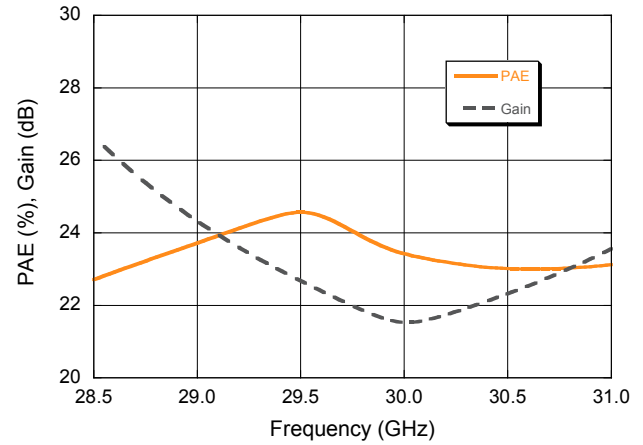

IM3 vs. Output Power (per tone)

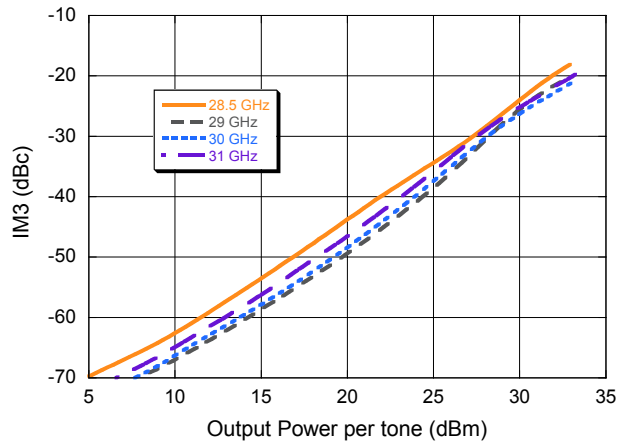

Output IP3 vs. Output Power (per tone)

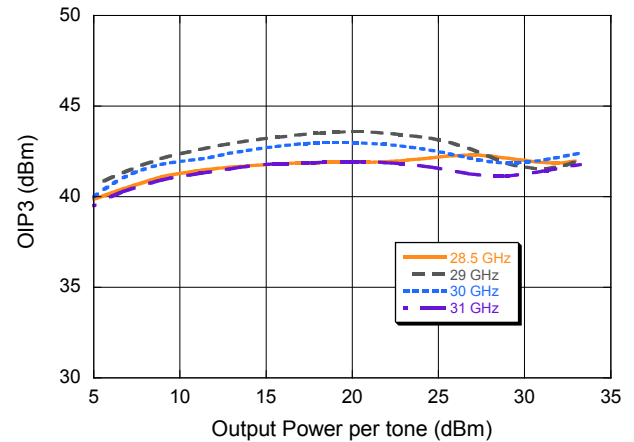

Typical Performance Curves

Output Power vs. Input Power

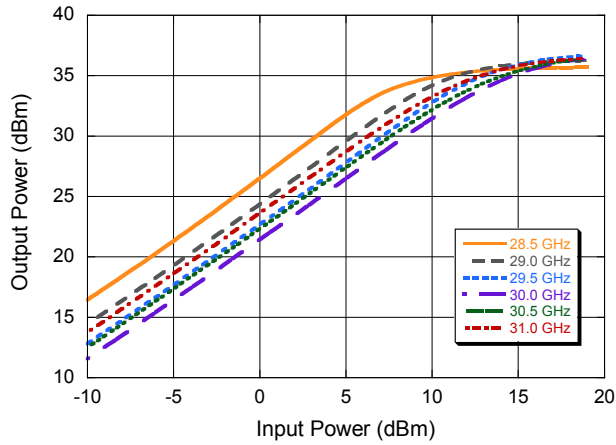

PAE vs. Input Power

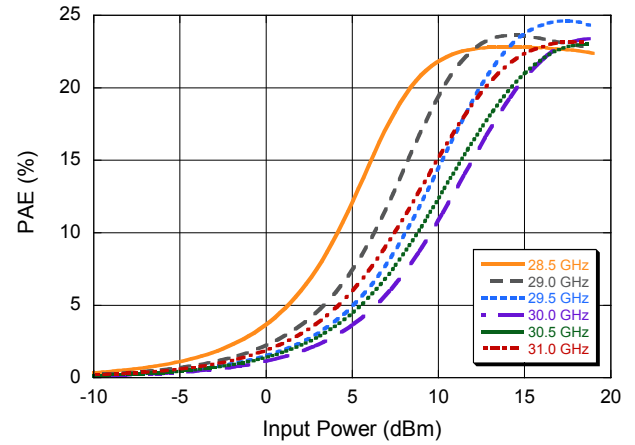

Bias Current vs. Input Power

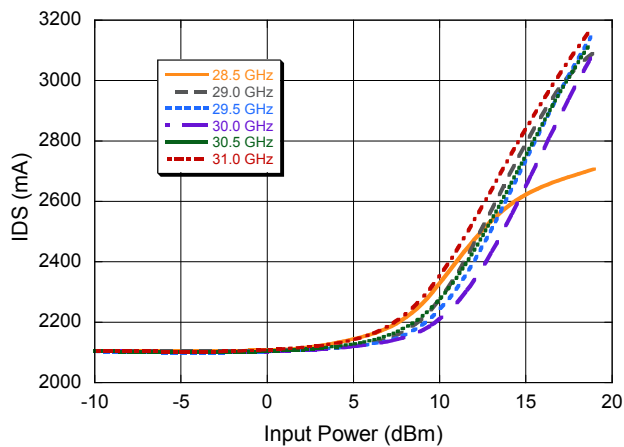

Quiescent Drain Current vs. Temperature

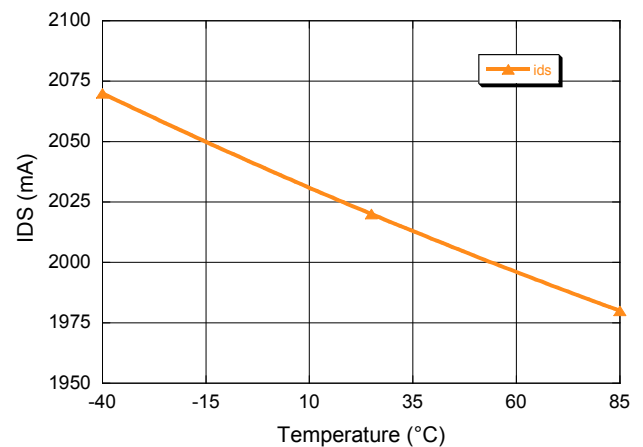

Lead-Free 5 mm QFN 32-Lead[†]

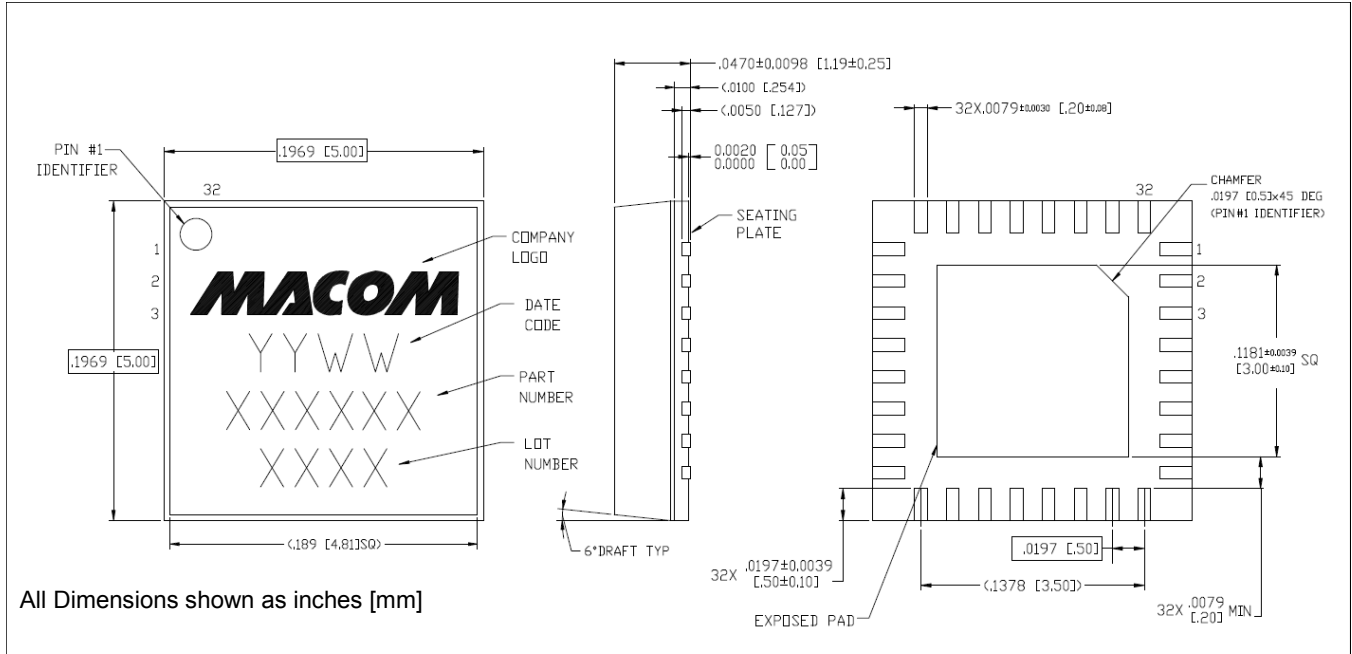

[†] Reference Application Note S2083 for lead-free solder reflow recommendations.
Meets JEDEC moisture sensitivity level 3 requirements.
Plating is NiPdAu.

M/A-COM Technology Solutions Inc. All rights reserved.

Information in this document is provided in connection with M/A-COM Technology Solutions Inc ("MACOM") products. These materials are provided by MACOM as a service to its customers and may be used for informational purposes only. Except as provided in MACOM's Terms and Conditions of Sale for such products or in any separate agreement related to this document, MACOM assumes no liability whatsoever. MACOM assumes no responsibility for errors or omissions in these materials. MACOM may make changes to specifications and product descriptions at any time, without notice. MACOM makes no commitment to update the information and shall have no responsibility whatsoever for conflicts or incompatibilities arising from future changes to its specifications and product descriptions. No license, express or implied, by estoppel or otherwise, to any intellectual property rights is granted by this document.

THESE MATERIALS ARE PROVIDED "AS IS" WITHOUT WARRANTY OF ANY KIND, EITHER EXPRESS OR IMPLIED, RELATING TO SALE AND/OR USE OF MACOM PRODUCTS INCLUDING LIABILITY OR WARRANTIES RELATING TO FITNESS FOR A PARTICULAR PURPOSE, CONSEQUENTIAL OR INCIDENTAL DAMAGES, MERCHANTABILITY, OR INFRINGEMENT OF ANY PATENT, COPYRIGHT OR OTHER INTELLECTUAL PROPERTY RIGHT. MACOM FURTHER DOES NOT WARRANT THE ACCURACY OR COMPLETENESS OF THE INFORMATION, TEXT, GRAPHICS OR OTHER ITEMS CONTAINED WITHIN THESE MATERIALS. MACOM SHALL NOT BE LIABLE FOR ANY SPECIAL, INDIRECT, INCIDENTAL, OR CONSEQUENTIAL DAMAGES, INCLUDING WITHOUT LIMITATION, LOST REVENUES OR LOST PROFITS, WHICH MAY RESULT FROM THE USE OF THESE MATERIALS.

MACOM products are not intended for use in medical, lifesaving or life sustaining applications. MACOM customers using or selling MACOM products for use in such applications do so at their own risk and agree to fully indemnify MACOM for any damages resulting from such improper use or sale.

Компания «Океан Электроники» предлагает заключение долгосрочных отношений при поставках импортных электронных компонентов на взаимовыгодных условиях!

Наши преимущества:

- Поставка оригинальных импортных электронных компонентов напрямую с производств Америки, Европы и Азии, а так же с крупнейших складов мира;
- Широкая линейка поставок активных и пассивных импортных электронных компонентов (более 30 млн. наименований);
- Поставка сложных, дефицитных, либо снятых с производства позиций;
- Оперативные сроки поставки под заказ (от 5 рабочих дней);
- Экспресс доставка в любую точку России;
- Помощь Конструкторского Отдела и консультации квалифицированных инженеров;
- Техническая поддержка проекта, помощь в подборе аналогов, поставка прототипов;
- Поставка электронных компонентов под контролем ВП;
- Система менеджмента качества сертифицирована по Международному стандарту ISO 9001;
- При необходимости вся продукция военного и аэрокосмического назначения проходит испытания и сертификацию в лаборатории (по согласованию с заказчиком);
- Поставка специализированных компонентов военного и аэрокосмического уровня качества (Xilinx, Altera, Analog Devices, Intersil, Interpoint, Microsemi, Actel, Aeroflex, Peregrine, VPT, Syfer, Eurofarad, Texas Instruments, MS Kennedy, Miteq, Cobham, E2V, MA-COM, Hittite, Mini-Circuits, General Dynamics и др.);

Компания «Океан Электроники» является официальным дистрибьютором и эксклюзивным представителем в России одного из крупнейших производителей разъемов военного и аэрокосмического назначения «JONHON», а так же официальным дистрибьютором и эксклюзивным представителем в России производителя высокотехнологичных и надежных решений для передачи СВЧ сигналов «FORSTAR».



JONHON

«JONHON» (основан в 1970 г.)

Разъемы специального, военного и аэрокосмического назначения:

(Применяются в военной, авиационной, аэрокосмической, морской, железнодорожной, горно- и нефтедобывающей отраслях промышленности)

«FORSTAR» (основан в 1998 г.)

ВЧ соединители, коаксиальные кабели, кабельные сборки и микроволновые компоненты:

(Применяются в телекоммуникациях гражданского и специального назначения, в средствах связи, РЛС, а так же военной, авиационной и аэрокосмической отраслях промышленности).



Телефон: 8 (812) 309-75-97 (многоканальный)

Факс: 8 (812) 320-03-32

Электронная почта: ocean@oceanchips.ru

Web: <http://oceanchips.ru/>

Адрес: 198099, г. Санкт-Петербург, ул. Калинина, д. 2, корп. 4, лит. А