

# Sonic Fast Recovery Diode

$$V_{RRM} = 4500 \text{ V}$$

$$I_{F80} = 43 \text{ A}$$

$$t_{rr} = 1450 \text{ ns}$$

High Performance Fast Recovery Diode  
Low Loss and Soft Recovery  
Single Diode

Part number

**DHG40I4500KO**

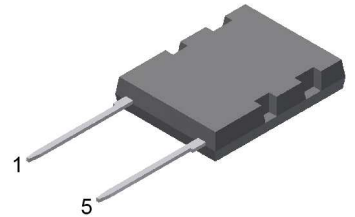

Backside: Isolated  
see important note page 3

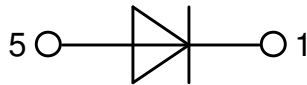

## Features / Advantages:

- Planar passivated chips
- Very low leakage current
- Very short recovery time
- Improved thermal behaviour
- Very low  $I_{rm}$ -values
- Very soft recovery behaviour
- Avalanche voltage rated for reliable operation
- Soft reverse recovery for low EMI/RFI
- Low  $I_{rm}$  reduces:
  - Power dissipation within the diode
  - Turn-on loss in the commutating switch

## Applications:

- Antiparallel diode for high frequency switching devices
- Snubber diode
- Free wheeling diode
- Rectifiers in switch mode power supplies (SMPS)
- Uninterruptible power supplies (UPS)

## Package: ISOPLUS264

- Isolation Voltage: 4200 V~
- Industry convenient outline
- RoHS compliant
- Epoxy meets UL 94V-0
- Soldering pins for PCB mounting
- Backside: DCB ceramic
- Reduced weight
- Advanced power cycling

## Terms and Conditions of Usage

The data contained in this product data sheet is exclusively intended for technically trained staff. The user will have to evaluate the suitability of the product for the intended application and the completeness of the product data with respect to his application. The specifications of our components may not be considered as an assurance of component characteristics. The information in the valid application- and assembly notes must be considered. Should you require product information in excess of the data given in this product data sheet or which concerns the specific application of your product, please contact your local sales office.

Due to technical requirements our product may contain dangerous substances. For information on the types in question please contact your local sales office.

Should you intend to use the product in aviation, in health or life endangering or life support applications, please notify. For any such application we urgently recommend

- to perform joint risk and quality assessments;

- the conclusion of quality agreements;

- to establish joint measures of an ongoing product survey, and that we may make delivery dependent on the realization of any such measures.

Fast Diode				Ratings			
Symbol	Definition	Conditions	min.	typ.	max.	Unit	
$V_{RSM}$	max. non-repetitive reverse blocking voltage	$T_{VJ} = 25^{\circ}C$			4500	V	
$V_{RRM}$	max. repetitive reverse blocking voltage	$T_{VJ} = 25^{\circ}C$			4500	V	
$I_R$	reverse current, drain current	$V_R = 4500\text{ V}$	$T_{VJ} = 25^{\circ}C$		100	$\mu A$	
		$V_R = 4500\text{ V}$	$T_{VJ} = 125^{\circ}C$		2	mA	
$V_F$	forward voltage drop	$I_F = 50\text{ A}$	$T_{VJ} = 25^{\circ}C$		3.00	V	
		$I_F = 100\text{ A}$				V	
		$I_F = 50\text{ A}$	$T_{VJ} = 125^{\circ}C$		3.50	V	
		$I_F = 100\text{ A}$				V	
$I_{FAV}$	average forward current	$T_C = 80^{\circ}C$ rectangular $d = 1.0$	$T_{VJ} = 150^{\circ}C$		43	A	
$V_{FO}$	threshold voltage	} for power loss calculation only	$T_{VJ} = 150^{\circ}C$		2.20	V	
$r_F$	slope resistance				24	m $\Omega$	
$R_{thJC}$	thermal resistance junction to case				0.5	K/W	
$R_{thCH}$	thermal resistance case to heatsink			0.15		K/W	
$P_{tot}$	total power dissipation		$T_C = 25^{\circ}C$		250	W	
$I_{FSM}$	max. forward surge current	$t = 10\text{ ms}; (50\text{ Hz}), \text{ sine}; V_R = 0\text{ V}$	$T_{VJ} = 45^{\circ}C$		600	A	
$C_J$	junction capacitance	$V_R = 1800\text{ V}$ $f = 1\text{ MHz}$	$T_{VJ} = 25^{\circ}C$		13	pF	
$I_{RM}$	max. reverse recovery current	} $I_F = 50\text{ A}; V_R = 2800\text{ V}$ $-di_F/dt = 800\text{ A}/\mu\text{s}$	$T_{VJ} = 25^{\circ}C$		80	A	
			$T_{VJ} = 125^{\circ}C$		82	A	
$t_{rr}$	reverse recovery time		$T_{VJ} = 25^{\circ}C$		1450	ns	
			$T_{VJ} = 125^{\circ}C$		2200	ns	

Package ISOPLUS264		Ratings				
Symbol	Definition	Conditions	min.	typ.	max.	Unit
$I_{RMS}$	RMS current	per terminal			70	A
$T_{VJ}$	virtual junction temperature		-40		150	°C
$T_{op}$	operation temperature		-40		125	°C
$T_{stg}$	storage temperature		-40		150	°C
<b>Weight</b>				10		g
$F_C$	mounting force with clip		20		120	N
$d_{Spp/App}$	creepage distance on surface   striking distance through air	terminal to terminal	13.8			mm
$d_{Spb/Apb}$		terminal to backside	5.0			mm
$V_{ISOL}$	isolation voltage	t = 1 second	4200			V
		t = 1 minute	3000			V

### Product Marking

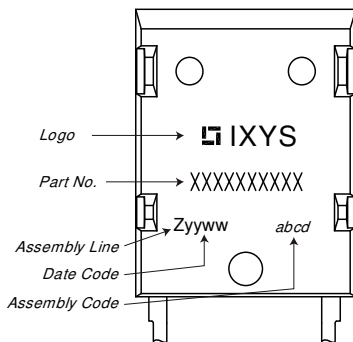

### Part description

- D = Diode
- H = Sonic Fast Recovery Diode
- G = extreme fast
- 40 = Current Rating [A]
- I = Single Diode
- 4500 = Reverse Voltage [V]
- KO = ISOPLUS264 (2HV)

Ordering	Ordering Number	Marking on Product	Delivery Mode	Quantity	Code No.
Standard	DHG40I4500KO	DHG40I4500KO			

### Equivalent Circuits for Simulation

\* on die level

$T_{VJ} = 150\text{ °C}$

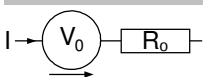

**Fast Diode**

$V_{0\ max}$	threshold voltage	2.2	V
$R_{0\ max}$	slope resistance *	24	mΩ

## Outlines ISOPLUS264

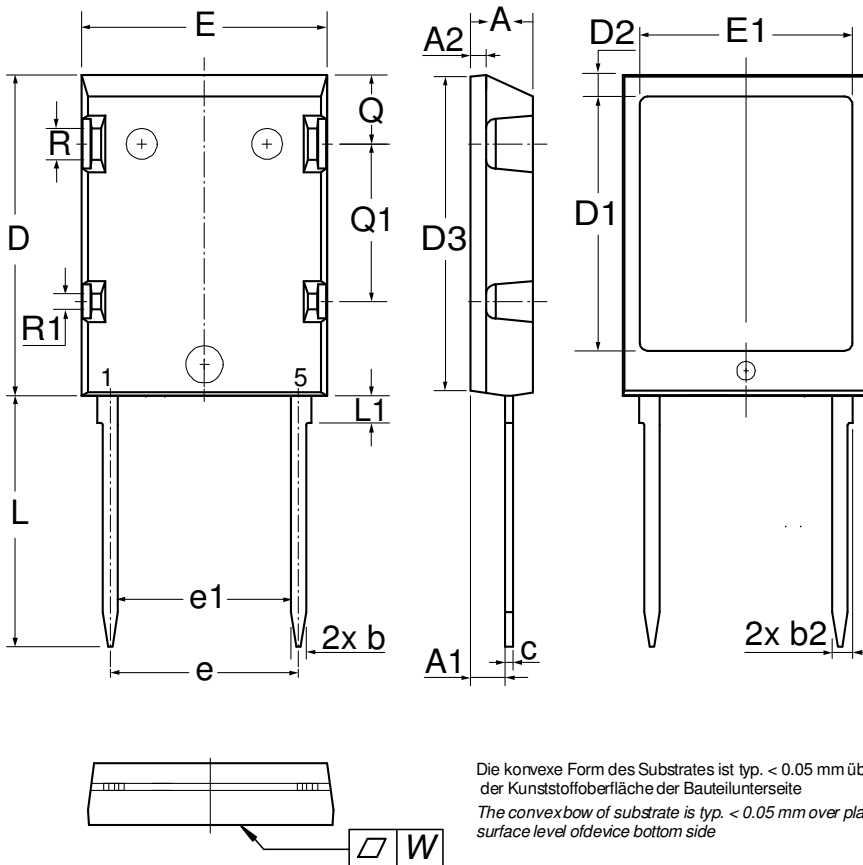

Dim.	Millimeter		Inches	
	min	max	min	max
A	4.83	5.21	0.190	0.205
A1	2.59	3.00	0.102	0.118
A2	1.17	1.40	0.046	0.055
b	1.14	1.40	0.045	0.055
b2	1.60	1.83	0.063	0.072
c	0.51	0.74	0.020	0.029
D	25.91	26.42	1.020	1.040
D1	20.34	20.85	0.801	0.821
D2	1.65	2.03	0.065	0.080
D3	25.29	25.78	1.000	1.020
E	19.56	20.29	0.770	0.799
E1	16.97	17.53	0.668	0.690
e	15.24	BSC	0.600	BSC
e1	14.10	BSC	0.555	BSC
L	19.81	20.83	0.780	0.820
L1	2.03	2.59	0.080	0.102
Q	5.33	5.97	0.210	0.235
Q1	12.45	13.03	0.490	0.513
R	3.81	4.57	0.150	0.180
R1	2.54	3.30	0.100	0.130
W	-	0.10	-	0.004

Die konvexe Form des Substrates ist typ. < 0.05 mm über der Kunststoffoberfläche der Bauteilunterseite  
 The convex bow of substrate is typ. < 0.05 mm over plastic surface level of device bottom side

### Important note:

External clearances between pins and between pins and tab may be insufficient to prevent flash over under all conditions. It is the customer's responsibility to apply additional insulation appropriate to the application.

ISOPLUS264 is designed to isolate a max continuous operation voltage (DC) of 1700 V. The peak test voltage of 4200 V assures safety for transient voltages only. The package is not tested for partial discharge.

If the product is used outside the package design voltage range the customer must use additional electrical insulation. Extra insulation layers should be used both between the tab and any heatsink and between any conducting clip and the top surface of the package particularly when metal parts (such as a heatsink or a clip) are in contact. Please note that the intention of this package is to provide customers with an encapsulated die for high voltage application but the responsibility rests entirely with the customer to ensure for safe operation. Bodily injury cannot be excluded if this warning is disregarded. Device implementation is the end user's responsibility.

For a low FIT rate over lifetime failures due to SEB (Single Event Burnout) and an adequate voltage derating should be considered.

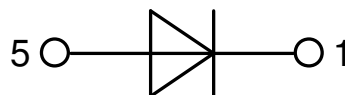

## Fast Diode

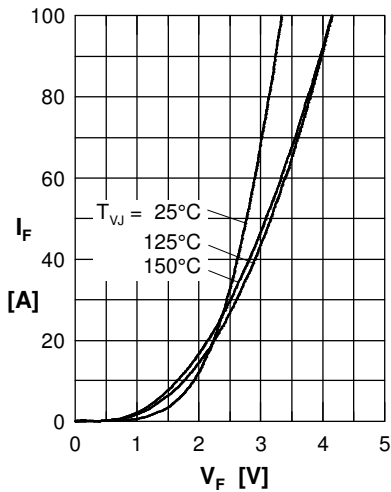

Fig. 1 Forward current  $I_F$  versus  $V_F$

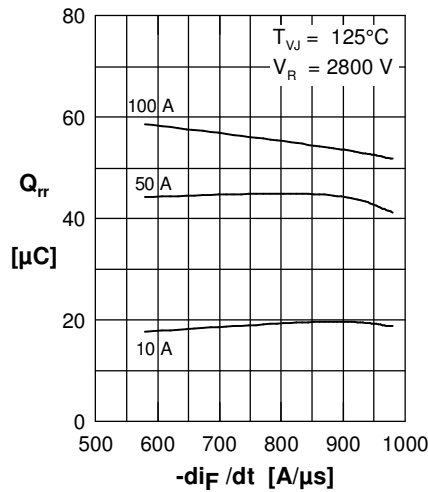

Fig. 2 Typ. reverse recov. charge  $Q_{rr}$  versus  $-di_F/dt$

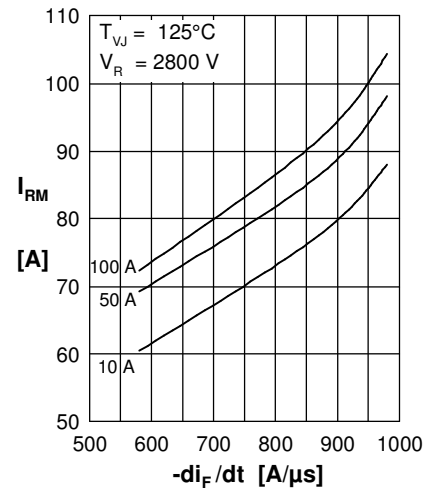

Fig. 3 Typ. reverse recov. current  $I_{RM}$  versus  $-di_F/dt$

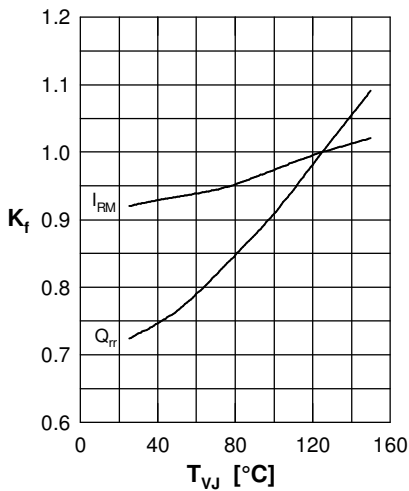

Fig. 4 Typ. dynamic parameters  $Q_{rr}$ ,  $I_{RM}$  versus  $T_{VJ}$

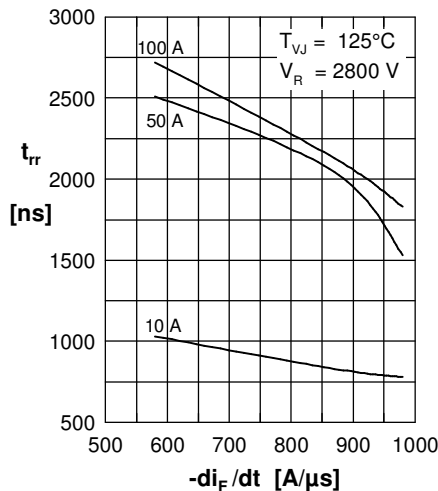

Fig. 5 Typ. reverse recov. time  $t_{rr}$  versus  $-di_F/dt$

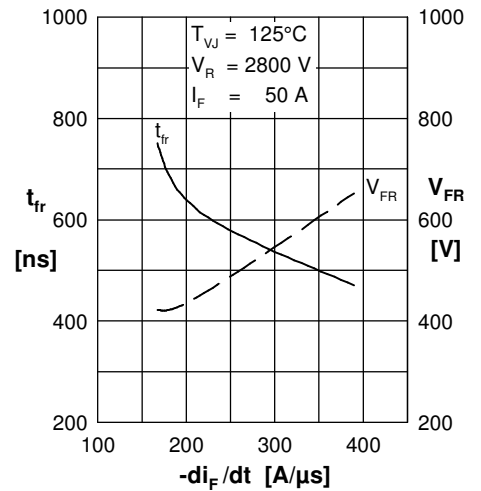

Fig. 6 Typ. forward recov. voltage  $V_{FR}$  & time  $t_{fr}$  versus  $di_F/dt$

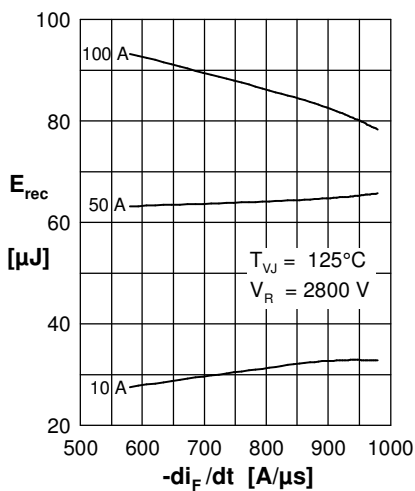

Fig. 7 Typ. recovery energy  $E_{rec}$  versus  $-di_F/dt$

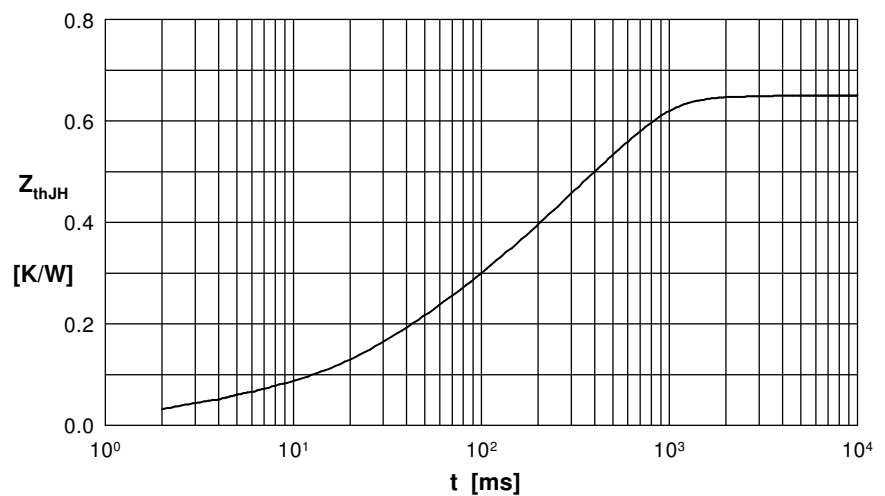

Fig. 8 Typical transient thermal impedance junction to heatsink

Компания «Океан Электроники» предлагает заключение долгосрочных отношений при поставках импортных электронных компонентов на взаимовыгодных условиях!

Наши преимущества:

- Поставка оригинальных импортных электронных компонентов напрямую с производств Америки, Европы и Азии, а так же с крупнейших складов мира;
- Широкая линейка поставок активных и пассивных импортных электронных компонентов (более 30 млн. наименований);
- Поставка сложных, дефицитных, либо снятых с производства позиций;
- Оперативные сроки поставки под заказ (от 5 рабочих дней);
- Экспресс доставка в любую точку России;
- Помощь Конструкторского Отдела и консультации квалифицированных инженеров;
- Техническая поддержка проекта, помощь в подборе аналогов, поставка прототипов;
- Поставка электронных компонентов под контролем ВП;
- Система менеджмента качества сертифицирована по Международному стандарту ISO 9001;
- При необходимости вся продукция военного и аэрокосмического назначения проходит испытания и сертификацию в лаборатории (по согласованию с заказчиком);
- Поставка специализированных компонентов военного и аэрокосмического уровня качества (Xilinx, Altera, Analog Devices, Intersil, Interpoint, Microsemi, Actel, Aeroflex, Peregrine, VPT, Syfer, Eurofarad, Texas Instruments, MS Kennedy, Miteq, Cobham, E2V, MA-COM, Hittite, Mini-Circuits, General Dynamics и др.);

Компания «Океан Электроники» является официальным дистрибьютором и эксклюзивным представителем в России одного из крупнейших производителей разъемов военного и аэрокосмического назначения «JONHON», а так же официальным дистрибьютором и эксклюзивным представителем в России производителя высокотехнологичных и надежных решений для передачи СВЧ сигналов «FORSTAR».



## JONHON

«JONHON» (основан в 1970 г.)

Разъемы специального, военного и аэрокосмического назначения:

(Применяются в военной, авиационной, аэрокосмической, морской, железнодорожной, горно- и нефтедобывающей отраслях промышленности)

«FORSTAR» (основан в 1998 г.)

ВЧ соединители, коаксиальные кабели, кабельные сборки и микроволновые компоненты:

(Применяются в телекоммуникациях гражданского и специального назначения, в средствах связи, РЛС, а так же военной, авиационной и аэрокосмической отраслях промышленности).



Телефон: 8 (812) 309-75-97 (многоканальный)

Факс: 8 (812) 320-03-32

Электронная почта: [ocean@oceanchips.ru](mailto:ocean@oceanchips.ru)

Web: <http://oceanchips.ru/>

Адрес: 198099, г. Санкт-Петербург, ул. Калинина, д. 2, корп. 4, лит. А