

Motor Contactor J7KN

- Range from 4 to 500 kW (AC 3, 380/415 V)
- AC and DC operated
- Integrated auxiliary contacts; integrated aux. contact of J7KN contactors up to 11kW suitable for electronic circuits
- Screw fixing and snap fitting (35 mm DIN rail) up to 37 kW
- Compliant to the global standards
- Finger proof (BGV A2)
- System contactors for Fuseless Load Feeders with integrated link modules
- All needed approvals like CE, UL, GOST & CCC. The J7KN fulfills the following standards; IEC 947-4-1, VDE 0660 and EN 60947-4-1.
- Accessories like auxiliary contacts front or/and side mounted, mechanical interlock and suppressor units.
- Mirror Contacts (NC) according to IEC 60947-4-1 for safety applications



Model Number Legend

1. Motor Contactors

J7KN-□-□-□-□-□ □
1 2 3 4 5 6

- 1) Motor Contactor
- 2) G for low DC control power consumption
- 3) Rated Motor Current.
D for integrated aux. contact for electronic circuits (except for 4-pole versions)
- 4) Integrated auxiliary contact configuration
- 5) Coil voltage
- 6) D for DC coil supply

2. Aux. Contact Modules for Motor Contactors

J73KN-□-□-□ □
1 2 3 4

- 1) Auxiliary Contact Modules
- 2) Motor contactors size
- 3) Combination of NO / NC contacts
- 4) Place of mounting

3. Accessories for Motor Contactors (Pneumatic Timers)

J74KN-□-□-□-□ □
1 2 3 4 5

- 1) Accessories for Motor Contactor
- 2) Motor contactors size
- 3) Pneumatic Timer
- 4) Time range
- 5) Function

4. Accessories for Motor Contactors (Mechanical Interlock)

J74KN-□-□ □
1 2 3

- 1) Accessories for Motor Contactor
- 2) Motor contactors size
- 3) Mechanical Interlock

5. Accessories for Motor Contactors (RS Suppressor units)

J74KN-□-□-□ □
1 2 3 4

- 1) Accessories for Motor Contactor
- 2) Motor contactors size
- 3) RS-surge suppressors
- 4) Voltage

6. Accessories for Motor Contactors (RC Suppressor units)

J74KN-□-□-□ □
1 2 3 4

- 1) Accessories for Motor Contactor
- 2) C2 = J7KN
- 3) RC = RC suppressor unit
- 4) Voltage

7. Accessories for Motor Contactors (Additional Terminals and Terminal Covers)

J74KN-□-□ □
1 2

- 1) Accessories for Motor Contactor
- 2) Version

8. Insulated wiring systems for Motor Contactors

J74-WK□-□ □
1 2 3

- 1) Additional reference for LVSG
- 2) WKR = Wiring Kit Reverser;
WKSD = Wiring Kit Star Delta
- 3) Version

■ Contactors

	Ratings				Rated current AC1	No. of Poles	Control circuit Power consum.		Aux. Contacts		Partnumber		Add. suffix for DC types coil voltage				
	AC2, AC3						Inrush	Hold	Built-in		front	side		Type ¹			
	380 V 400 V 415 V kW	500 V kW	660 V 690 V kW	690 V A					NO	NC ²					Number of contacts	Number of contacts	Voltage specification
 J7KN-AC	4	5,5	5,5	25	3	33-45	7-10	1	–	4	–	J7KN-10D-10 □□□	–				
					4			–	1			J7KN-10D-01 □□□					
					3	3	3	1	–			3		–	J7KNG-10-10 □□□		
					4			–	1						J7KNG-10-01 □□□		
					3	75	2	1	–			3		–	J7KN-10D-10 □□□		
					4			–	1						J7KN-10D-01 □□□		
	 J7KNG	5,5	7,5	7,5	25	3	33-45	7-10	1	–	4	–	J7KN-14D-10 □□□	–			
						4			–	1			J7KN-14D-01 □□□				
						3	3	3	1	–			3		–	J7KNG-14-10 □□□	
						4			–	1						J7KNG-14-01 □□□	
						3	75	2	1	–			3		–	J7KN-14D-10 □□□	
						4			–	1						J7KN-14D-01 □□□	
 J7KN-DC		7,5	10	10	32	3	33-45	7-10	1	–	4	–	J7KN-18D-10 □□□	–			
						4			–	1			J7KN-18D-01 □□□				
						3	3	3	1	–			3		–	J7KNG-18-10 □□□	
						4			–	1						J7KNG-18-01 □□□	
						3	75	2	1	–			3		–	J7KN-18D-10 □□□	
						4			–	1						J7KN-18D-01 □□□	
	 J7KN-AC J7KNG J7KN-DC	11	15	15	50	3	90-115	9-13	–	–	4	–	J7KN-24 □□□	–			
						4	4	3					J7KNG-24 □□□				
						140	2						J7KN-24 □□□				
		15	18,5	18,5	65	3	90-115	9-13	–	–			4	–	J7KN-32 □□□	–	
						4	4	3							J7KNG-32 □□□		
						140	2								J7KN-32 □□□		
18,5		18,5	18,5	80	3	90-115	9-13	–	–	4	–	J7KN-40 □□□			–		
					4	4	3					J7KNG-40 □□□					
					140	2						J7KN-40 □□□					
 J7KN-AC J7KN-DC		22	30	30	110	3	140-185	13-18	–			–	4	–	J7KN-50 □□□	–	
						200	6	J7KN-50 □□□									
		30	37	37	120	3	140-185	13-18	–			–			4	–	J7KN-62 □□□
	200					6	J7KN-62 □□□										
	37	45	45	130	3	140-185	13-18	–	–	4	–	J7KN-74 □□□					–
					200	6	J7KN-74 □□□										

	Ratings				Rated current AC1	No. of Poles	Control circuit Power consum.		Aux. Contacts				Partnumber	
	AC2, AC3		500 V 660 V 690 V	690 V			AC type VA DC type W		Built-in		Additional			Type ^{*1} Voltage specification 24 48 110 230
	380 V 400 V 415 V kW	kW			kW	A	Inrush	Hold	NO	NC ^{*2}	front	side	Number of contacts	
 J7KN-90/115	45	55	55	160	3	190-280 VA	2.5-5 VA							J7KN-90 □□□□ ^{*3}
	55	55	55	200		280 W	5 W			7	4			J7KN-115 □□□□ ^{*3}
 J7KN-151/176	75	75	75	230	3	350	5	-	-	4	2			J7KN-151 □□□□ ^{*3}
				4	J7KN-151-4 □□□□ ^{*3}									
	90	90	90	250	3									J7KN-176 □□□□ ^{*3}
					4									J7KN-176-4 □□□□ ^{*3}
 J7KN-210 to 316	110	160	160	350	3	360	5	-	-	4	4			J7KN-210 □□□□ ^{*3}
	132	210	210	450										J7KN-260 □□□□ ^{*3}
	160	250	250	500										J7KN-316 □□□□ ^{*3}
 J7KN-450 to 860	250	375	375	600	3	800-950 VA	9-11 VA	2	2	4	-			J7KN-450-22 □□□□ ^{*3}
	300	475	475	760		750-850 W	8-10 W							J7KN-550-22 □□□□ ^{*3}
	400	630	630	1000		1350-1600 VA	21-25 VA							J7KN-700-22 □□□□ ^{*3}
	500	700	700	1100		1300-1550 W	18-22 W							J7KN-860-22 □□□□ ^{*3}

*1 For more coil voltages refer to Appendix.

*2 Mirror Contact (NC) according to IEC 60947-4-1 for safety applications

*3 Universal Current models (AC and DC operated)

Additional products

Auxiliary Contacts Blocks

	Rated Operational Current			Mounting + comments	Contacts		Suitable for Contactors	Partnumber
	AC15 230V	AC15 400V	AC1 690V					
	3	2	10	Front, standard version	1	–	J7KN-10D up to J7KN-115	J73KN-B-10 ²
	3	2	10		–	1		J73KN-B-01 ²
	3	2	10	EM/LB version (early make/late break)	1	–		J73KN-B-10U ²
	3	2	10		–	1		J73KN-B-01U ²
	6	4	25	High current version	1	–		J73KN-B-10A ²
	6	4	25		–	1		J73KN-B-01A ²
	3	2	10	Side version, max. 2 pcs per contactor	1	1	J7KN-24 up to J7KN-115	J73KN-C-11S ²
	3	2	10	Front version, max. 1 pcs per contactor	1	1	J7KN-151 up to J7KN-316	J73KN-D-11F
	3	2	10		2	2		J73KN-D-22F
	3	2	10	Side version, max. 2 pcs per contactor	1	1	J7KN-151 up to J7KN-316	J73KN-D-11S
	3	2	10	Front version, max. 1 pcs per contactor	2	2	J7KN-450 up to J7KN-860	J73KN-E-22F

¹ Mirror Contact (NC) according to IEC 60947-4-1 for safety applications.

² Contacts suitable for electronic circuits, according to IEC60947-5-4 for rated voltage 24 VDC (test ratings 17 VDC, 5 mA). Positively guided contacts. Technical data see page 24.

Pneumatic Timer

	Function	Time range s	Mounting + comments	Contacts				Suitable for Contactors	Partnumber
									
	On-delay	0.1 - 40	Front	1	1	–	–	Front for contactors J7KN-10D up to J7KN-40	J74KN-B-TP40DA
	On-delay	10 - 180		1	1	–	–		J74KN-B-TP180DA
	Off-delay	0.1 - 40		–	–	1	1		J74KN-B-TP40IA
	Off-delay	10 - 180		–	–	1	1		J74KN-B-TP180IA

Mechanical Interlocks

	Interlocks contactors with contactors (dimensions need to be the same)	Partnumber	
Type	Type	Type	
	J7KN(G)-10(D) - J7KN(G)-40	+ J7KN(G)-10(D) - J7KN(G)-40	J74KN-B-ML
	J7KN-24 - J7KN-74	+ J7KN-24 - J7KN-74	J74KN-C-ML
	J7KN-90 - J7KN-115	+ J7KN-90 - J7KN-115	J74KN-D2-ML
	J7KN-151 - J7KN-316	+ J7KN-151 - J7KN-316	J74KN-E-ML

Suppressor units

	Function	For Contactors	Voltages		Partnumber Type
	RC-Unit snap on contactor	J7KN-10D - J7KN-74	12 - 48 V 48 - 127 V 110 - 230 V 230 - 415 V	AC/DC AC/DC AC/DC AC/DC	J74KN-C2-RC24 J74KN-C2-RC110 J74KN-C2-RC230 J74KN-C2-RC400

Additional products

	Function	For Contactors	Specification Cable Cross-section to clamp mm ²			Partnumber
			solid or stranded	flexible	flex. with multicore cable end	Type
	Terminals single pole	J7KN-50 - J7KN-74	4 - 35	6 - 25	4 - 25	J74KN-LG-9030 (3pcs set)
		J7KN-151 - J7KN-176	16 - 120	–	16 - 95	J74KN-LG-11224
	Terminal cover for terminal protection according DIN 57106, BVG-A2	J7KN-151 - J7KN-176 3-pole	for 3 terminals; 2 units for one contactor			J74KN-LG-10404
		J7KN-210 - J7KN-316				J74KN-LG-11457
	Marking system for contactors and aux. contactblocks	J7KN-10 to J7KN-74 & J73KN-B	2-section without marking, divisible			J74KN-P487-1
			4-section without marking, divisible			J74KN-P245-1

Insulated wiring systems for motor contactors

	Function	For Contactors	Specification Maximum current	Partnumber Type
	For reversing contactors (2 parts)	J7KN-10D - J7KN-22D	22	J74-WKR-B2
		J7KN-24 - J7KN-40	40	J74-WKR-C
	For star-delta combination (4 parts)	J7KN-10D - J7KN-22D	22	J74-WKSD-B2
		J7KN-24 - J7KN-40	40	J74-WKSD-C

Wiring Diagrams Coil Circuit / Terminal marking Contactors

Range	Supply	Wiring coil circuit	Terminal marking
J7KN-10D/14D/18D/22D-10	AC		
J7KN-10D/14D/18D/22D-01	AC		
J7KNG-10/14/18/22-10	DC		
J7KNG-10/14/18/22-01	DC		
J7KN-10D/14D/18D/22D-10...D	DC with double wiring coil		
J7KN-10D/14D/18D/22D-01...D	DC with double wiring coil		
J7KN-10D/14D/18D/22D-4	AC		
J7KNG-10/14/18/22-4	DC		
J7KN-24/32/40/50/62/74	AC		
J7KNG-24/32/40	DC		
J7KN-24/32/40/50/62/74D	DC with double wiring coil		
J7KN-90/115/151/176 J7KN-210/260/316	AC/DC		
J7KN- 151/176-4	AC/DC		
J7KN- 450/550/700/860	AC/DC		

Auxiliary Contacts

Range	Contactors	Terminal marking
J73KN-B-10	J7KN-10D/14D/18D/22D/24/32/40/50/62/74/90/115 J7KNG-10/14/18/22/24/32/40	
J73KN-B-01 (U/A)	J7KN-24/32/40/50/62/74/90/115 J7KNG-24/32/40	
J73KN-C-11S	J7KN-10D/14D/18D/22D/24/32/40/50/62/74/90/115 J7KNG-10/14/18/22/24/32/40	(left side) (right side) 
J73KN-D-11F	J7KN-151 up to J7KN-316	
J73KN-D-22F	J7KN-151 up to J7KN-316	
J73KN-D-11S	J7KN-151 up to J7KN-316	
J73KN-E-22F	J7KN-450 up to J7KN-860	

Pneumatic timer

Range	Contactors	Terminal marking
J73KN-B-TP...DA ON-delay	J7KN-10D/14D/18D/22D/24/32/40 J7KNG-10/14/18/22/24/32/40	
J73KN-B-TP...IA OFF-delay	J7KN-10D/14D/18D/22D/24/32/40 J7KNG-10/14/18/22/24/32/40	

Coil voltage

Type-suffix for Contactors

Contactor range	Suffix	Marking at coil		Rated Control Voltage U_s			
		50Hz V	60Hz V	50Hz min V	max V	60Hz min V	max V
J7KN-10D to J7KN-74	24	24	24	22	24	24	27
	48	48	48	44	48	48	52
	110	110	110-120	100	110	110	122
	180	180-210	200-240	180	210	200	240
	230	220-240	230-264	220	240	230	264
	400	380-415	400-440	380	415	400	460
J7KN-90 to J7KN-860	500	500-550	550-600	500	550	550	600
	24	24	24	24	24	24	24
	48	48	48	48	48	48	48
	110	110-120	110-120	110	120	110	120
	230	220-240	220-240	220	240	220	240
	400	380-415	380-415	380	415	380	415

Operating range of magnet-coils:

AC: $0.85 \times U_s$ (min. value of rated control voltage) up to $1.1 \times U_s$ (max. value of rated control voltage).

DC: $0.8 \times U_s$ (min. value of rated control voltage) up to $1.1 \times U_s$ (max. value of rated control voltage).

■ Engineering data and characteristics

Approximate Values for three-phase Motors

Motor Full Load Currents

Approximate values of motor F.L.C. and minimum „slow blow“ respectively „gL“ short-circuit fuse

Motor rating Range according to BS for 415V					220-230V Motor Value of fusing at motor start			240V Motor Value of fusing at motor start			380-400V Motor Value of fusing at motor start			415V Motor Value of fusing at motor start			500V Motor Value of fusing at motor start			660-690V Motor Value of fusing at motor start		
kW	PS-hp	hp	cos	%	F.L.C. A	D.O.L. A	YD A	F.L.C. A	D.O.L. A	YD A	F.L.C. A	D.O.L. A	YD A	F.L.C. A	D.O.L. A	YD A	F.L.C. A	D.O.L. A	YD A	F.L.C. A	D.O.L. A	YD A
0.06	0.08	-	0.7	59	0.38	1	1	0.35	1	1	0.22	1	1	-	-	-	0.16	1	1	-	-	-
0.09	0.12	-	0.7	60	0.55	2	2	0.5	2	2	0.33	1	1	-	-	-	0.24	1	1	-	-	-
0.12	0.16	-	0.7	61	0.76	2	2	0.68	2	2	0.42	2	2	-	-	-	0.33	1	1	-	-	-
0.18	0.24	-	0.7	61	1.1	2	2	1	2	2	0.64	2	2	-	-	-	0.46	1	1	-	-	-
0.25	0.34	-	0.7	62	1.4	4	2	1.38	4	2	0.88	2	2	-	-	-	0.59	2	2	-	-	-
0.37	0.5	-	0.72	64	2.1	4	4	1.93	4	4	1.22	4	2	-	-	-	0.85	2	2	0.7	2	2
0.55	0.75	-	0.75	69	2.7	4	4	2.3	4	4	1.5	4	2	-	-	-	1.2	4	2	0.9	2	2
0.75	1	1	0.8	74	3.3	6	4	3.1	6	4	2	4	4	2	4	4	1.48	4	2	1.1	2	2
1.1	1.5	1.5	0.83	77	4.9	10	6	4.1	6	6	2.6	4	4	2.5	4	4	2.1	4	4	1.5	4	2
1.5	2	2	0.83	78	6.2	10	10	5.6	10	10	3.5	6	4	3.5	6	4	2.6	4	4	2	4	4
2.2	3	3	0.83	81	8.7	16	10	7.9	16	10	5	10	6	5	10	6	3.8	6	6	2.9	6	4
2.5	3.4	-	0.83	81	9.8	16	16	8.9	16	10	5.7	10	10	-	-	-	4.3	6	6	-	-	-
3	4	4	0.84	81	11.6	20	16	10.6	20	16	6.6	16	10	6.5	16	10	5.1	10	10	3.5	6	4
3.7	5	5	0.84	82	14.2	25	20	13	25	16	8.2	16	10	7.5	16	10	6.2	16	10	-	-	-
4	5.5	-	0.84	82	15.3	25	20	14	25	20	8.5	16	10	-	-	-	6.5	16	10	4.9	10	6
5.5	7.5	7.5	0.85	83	20.6	35	25	18.9	35	25	11.5	20	16	11	20	16	8.9	16	10	6.7	16	10
7.5	10	10	0.86	85	27.4	35	35	24.8	35	35	15.5	25	20	14	25	16	11.9	20	16	9	16	10
8	11	-	0.86	85	28.8	50	35	26.4	35	35	16.7	25	20	-	-	-	12.7	20	16	-	-	-
11	15	15	0.86	87	39.2	63	50	35.3	50	50	22	35	25	21	35	25	16.7	25	20	13	25	16
12.5	17	-	0.86	87	43.8	63	50	40.2	63	50	25	35	35	-	-	-	19	35	25	-	-	-
15	20	20	0.86	87	52.6	80	63	48.2	80	63	30	50	35	28	35	35	22.5	35	25	17.5	25	20
18.5	25	25	0.86	88	64.9	100	80	58.7	80	63	37	63	50	35	50	50	28.5	50	35	21	35	25
20	27	-	0.86	88	69.3	100	80	63.4	80	80	40	63	50	-	-	-	30.6	50	35	-	-	-
22	30	30	0.87	89	75.2	100	80	68	100	80	44	63	50	40	63	50	33	50	50	25	35	35
25	34	-	0.87	89	84.4	125	100	77.2	100	100	50	80	63	-	-	-	38	63	50	-	-	-
30	40	40	0.87	90	101	125	125	92.7	125	100	60	80	63	55	80	63	44	63	50	33	50	35
37	50	50	0.87	90	124	160	160	114	160	125	72	100	80	66	100	80	54	80	63	42	63	50
40	54	-	0.87	90	134	160	160	123	160	160	79	100	100	-	-	-	60	80	63	-	-	-
45	60	60	0.88	91	150	200	160	136	200	160	85	125	100	80	100	100	64.5	100	80	49	63	63
51	70	-	0.88	91	168	200	200	154	200	200	97	125	100	-	-	-	73.7	100	80	-	-	-
55	75	-	0.88	91	181	250	200	166	200	200	105	160	125	-	-	-	79	125	100	60	80	63
59	80	80	0.88	91	194	250	250	178	250	200	112	160	125	105	160	125	85.3	125	100	-	-	-
75	100	100	0.88	91	245	315	250	226	315	250	140	200	160	135	200	160	106	160	125	82	125	100
90	125	125	0.88	92	292	400	315	268	315	315	170	250	200	165	200	200	128	160	160	98	125	125
110	150	150	0.88	92	358	500	400	327	400	400	205	250	250	200	250	250	156	200	200	118	160	125
129	175	175	0.88	92	420	500	500	384	500	400	242	315	250	230	315	250	184	250	200	-	-	-
132	180	-	0.88	92	425	500	500	393	500	500	245	315	250	-	-	-	186	250	200	140	200	160
147	200	200	0.88	93	472	630	630	432	630	500	273	315	315	260	315	315	207	250	250	-	-	-
160	220	-	0.88	93	502	630	630	471	630	630	295	400	315	-	-	-	220	315	250	170	200	200
184	250	250	0.88	93	590	800	630	541	630	630	340	400	400	325	400	400	259	315	315	-	-	-
200	270	-	0.88	93	626	800	800	589	800	630	370	500	400	-	-	-	278	315	315	215	250	250
220	300	300	0.88	93	700	1000	800	647	800	800	408	500	500	385	500	400	310	400	400	-	-	-
250	340	-	0.88	93	803	1000	1000	736	1000	800	460	630	500	-	-	-	353	500	400	268	315	315
257	350	350	0.88	93	826	1000	1000	756	1000	800	475	630	630	450	630	500	363	500	400	-	-	-
295	400	400	0.88	93	948	1250	1000	868	1000	1000	546	800	630	500	630	630	416	500	500	-	-	-
315	430	-	0.88	93	990	1250	1250	927	1250	1000	580	800	630	-	-	-	445	630	500	337	400	400
355	483	-	0.89	95	-	-	-	-	-	-	636	800	800	-	-	-	483	630	630	366	500	400
400	545	-	0.89	96	-	-	-	-	-	-	710	1000	800	-	-	-	538	630	630	410	500	500

The motor F.L.C. be valid for standard internal and surface cooled three-pole motors with 1500 min⁻¹. The fuses values be valid for the motor F.L.C. shown in the table and D.O.L.-start: starting current max. 6x motor F.L.C., starting time max. 5s; star-delta-start: starting current max. 2x motor F.L.C., starting time max. 15s. For motors with higher F.L.C., higher starting current and / or longer starting time, larger short-circuit fuses are required.

The maximum admissible value is dependent on the switchgear respectively thermal overload relay.

Approximate values of motor F.L.C. according to CSA and UL

Motor rating hp	Motor F.L.C. at 110-120V			Motor F.L.C. at 220-240V ^{*1}			Motor F.L.C. at 440-480V			Motor F.L.C. at 550-600V		
	1-phase A	2-phase A	3-phase A	1-phase A	2-phase A	3-phase A	1-phase A	2-phase A	3-phase A	1-phase A	2-phase A	3-phase A
1/2	9.8	4.0	4.4	4.9	2.0	2.2	2.5	1.0	1.1	2.0	0.8	0.9
3/4	13.8	4.8	6.4	6.9	2.4	3.2	3.5	1.2	1.6	2.8	1.0	1.3
1	16.0	6.4	8.4	8.0	3.2	4.2	4.0	1.6	2.1	3.2	1.3	1.7
1 1/2	20.0	9.0	12.0	10.0	4.5	6.0	5.0	2.3	3.0	4.0	1.8	2.4
2	24.0	11.8	13.6	12.0	5.9	6.8	6.0	3.0	3.4	4.8	2.4	2.7
3	34.0	16.6	19.2	17.0	8.3	9.6	8.5	4.2	4.8	6.8	3.3	3.9
5	56.0	26.4	30.4	28.0	13.2	15.2	14.0	6.6	7.6	11.2	5.3	6.1
7 1/2	80.0	38.0	44.0	40.0	19.0	22.0	21.0	9.0	11.0	16.0	8.0	9.0
10	100.0	48.0	56.0	50.0	24.0	28.0	26.0	12.0	14.0	20.0	10.0	11.0
15	135.0	72.0	84.0	68.0	36.0	42.0	34.0	18.0	21.0	27.0	14.0	17.0
20	-	94.0	108.0	88.0	47.0	54.0	44.0	23.0	27.0	35.0	19.0	22.0
25	-	118.0	136.0	110.0	59.0	68.0	55.0	29.0	34.0	44.0	24.0	27.0
30	-	138.0	160.0	136.0	69.0	80.0	68.0	35.0	40.0	54.0	28.0	32.0
40	-	180.0	208.0	176.0	90.0	104.0	88.0	45.0	52.0	70.0	36.0	41.0
50	-	226.0	260.0	216.0	113.0	130.0	108.0	56.0	65.0	86.0	45.0	52.0
60	-	-	-	-	133.0	145.0	-	67.0	77.0	-	53.0	62.0
75	-	-	-	-	166.0	192.0	-	83.0	96.0	-	66.0	77.0
100	-	-	-	-	218.0	248.0	-	109.0	124.0	-	87.0	99.0
125	-	-	-	-	-	312.0	-	135.0	156.0	-	108.0	125.0
150	-	-	-	-	-	360.0	-	156.0	180.0	-	125.0	144.0
200	-	-	-	-	-	480.0	-	208.0	240.0	-	167.0	192.0
250	-	-	-	-	-	602.0	-	-	302.0	-	-	242.0
300	-	-	-	-	-	-	-	-	361.0	-	-	289.0
350	-	-	-	-	-	-	-	-	414.0	-	-	336.0
400	-	-	-	-	-	-	-	-	477.0	-	-	382.0
500	-	-	-	-	-	-	-	-	590.0	-	-	472.0

*1 Determine the motor current for 200V and 208V by increasing the values for 220-240V at 200V about 15% and for 208V about 10%.

Contactors

Data according to IEC 60947-4-1, EN 60947-4-1, VDE 0660

Main Contacts	Type	J7KN(G)-10(D)	J7KN(G)-14(D)	J7KN(G)-18(D)	J7KN(G)-22(D)	J7KN(G)-24	J7KN(G)-32	J7KN(G)-40	J7KN-50
Rated insulation voltage U_i^{*1}	V AC	690	690	690	690	690	690	690	690
Making capacity I_{eff}	at $U_e = A$ 690V AC	200	200	200	200	400	500	500	700
Breaking capacity I_{eff}	400V AC A	180	180	200	200	380	400	400	600
J7KN-09 to J7KN-22	500V AC A	150	150	180	180	300	370	370	500
J7KN-24 to J7KN-860	690V AC A	100	100	150	150	260	340	340	400
	1000V AC A	–	–	–	–	–	–	–	–
Utilization category AC1									
Switching of resistive load									
Rated operational current $I_e (=I_{th})$ at 40°C, open	690V A	25	25	32	32	50	65	80	110
Rated operational power of three-phase resistive loads	220V kW	9,5	9,5	12,2	12,2	19,0	24,7	30,4	41,9
	230V kW	9,9	9,9	12,7	12,7	19,9	25,9	31,8	43,8
	240V kW	10,4	10,4	13,3	13,3	20,8	27,0	33,2	45,7
	380V kW	16,4	16,4	21,0	21,0	32,9	42,7	52,6	72,3
	400V kW	17,3	17,3	22,1	22,1	34,6	45,0	55,4	76,1
	415V kW	17,9	17,9	23,0	23,0	35,9	46,7	57,4	79,0
	440V kW	19,0	19,0	24,4	24,4	38,1	49,5	60,9	83,7
	500V kW	21,6	21,6	27,7	27,7	43,3	56,2	69,2	95,2
	660V kW	28,5	28,5	36,5	36,5	57,1	74,2	91,3	125,6
	690V kW	29,8	29,8	38,2	38,2	59,7	77,6	95,5	131,3
	1000V kW	–	–	–	–	–	–	–	–
Rated operational current $I_e (=I_{the})$ at 60°C, enclosed	690V A	25	25	32	32	40	55	65	90
Rated operational power of three-phase resistive loads	220V kW	9,5	9,5	12,2	12,2	15,2	20,9	24,7	34,3
	230V kW	9,9	9,9	12,7	12,7	15,9	21,9	25,9	35,8
	240V kW	10,4	10,4	13,3	13,3	16,6	22,8	27,0	37,4
	380V kW	16,4	16,4	21,0	21,0	26,3	36,2	42,7	59,2
	400V kW	17,3	17,3	22,1	22,1	27,7	38,1	45,0	62,3
	415V kW	17,9	17,9	23,0	23,0	28,7	39,5	46,7	64,6
	440V kW	19,0	19,0	24,4	24,4	30,4	41,9	49,5	68,5
	500V kW	21,6	21,6	27,7	27,7	34,6	47,6	56,2	77,9
	660V kW	28,5	28,5	36,5	36,5	45,7	62,8	74,2	102,8
	690V kW	29,8	29,8	38,2	38,2	47,7	65,7	77,6	107,4
	1000V kW	–	–	–	–	–	–	–	–
Minimum cross-section of conductor at load with $I_e (=I_{th})$	mm ²	4	4	6	6	10	16	25	35
Utilization category AC2 and AC3									
Switching of three-phase motors									
Rated operational current I_e open and enclosed	220V A	12	15	18	22	24	30	40	50
	230V A	11,5	14,5	18	22	24	30	40	50
	240V A	11	14	18	22	24	32	40	50
	380-400V A	10	14	18	22	24	32	40	50
	415V A	9	14	18	22	23	30	40	50
	440V A	9	14	18	22	23	30	40	50
	500V A	7	9	9	9	17,5	21	21	33
	660-690V A	6,5	8,5	8,5	8,5	17	20	20	31
	1000V A	–	–	–	–	–	–	–	–
Rated operational power of three-phase motors	220-230V kW	3	4	5	6	6	8,5	11	12,5
	240V kW	3	4	5	7	7	9	11,5	13,5
	380-400V kW	4	5,5	7,5	11	11	15	18,5	22
	415V kW	4,5	6	8,5	12	12	16	20	24
	440V kW	4,5	6	8,5	12	12	16	20	24
	500V kW	5,5	7,5	10	10	15	18,5	18,5	30
	660-690V kW	5,5	7,5	10	10	15	18,5	18,5	30
	1000V kW	–	–	–	–	–	–	–	–

*1 Suitable at 690V for: earthed-neutral systems, overvoltage I to IV, pollution degree 3 (standard-industry): $U_{imp} = 8kV$.
Data for other conditions on request.

Contactors

Data according to IEC 60947-4-1, EN 60947-4-1, VDE 0660

Type	J7KN-62	J7KN-74	J7KN-90	J7KN-115	J7KN-151	J7KN-176	J7KN-210	J7KN-260	J7KN-316	J7KN-450	J7KN-550	J7KN-700	J7KN-860
V~	690	690	1000	1000	1000	1000	1000	1000	1000	1000	1000	690	690
A	900	900	1100	1200	1500	2000	2100	2600	3200	4500	5500	7000	8600
A	800	800	950	1100	1200	1500	1600	2100	2600	4500	5500	7000	8000
A	700	700	850	1000	1200	1500	1600	2100	2600	4500	5500	7000	8000
A	500	500	600	600	1000	800	1200	1900	2300	3200	4400	5600	6900
A	–	–	–	–	500	600	700	850	1000	–	–	–	–
A	120	130	160	200	230	250	350	450	500	700	760	1000	1100
kW	45,7	49,5	60	76	87	95	133	171	190	266	289	381	419
kW	47,7	51,7	63	79	91	99	139	179	199	279	302	398	438
kW	49,8	54,0	66	83	95	103	145	187	207	291	315	415	457
kW	78,9	85,5	105	131	151	164	230	296	329	460	500	658	724
kW	83,0	90,0	110	138	159	173	242	311	346	485	426	692	762
kW	86,2	93,3	115	143	165	179	251	323	359	503	546	718	790
kW	91,3	99,0	121	152	175	190	266	342	381	533	579	762	838
kW	103,8	112,5	138	173	199	216	303	389	453	606	658	866	952
kW	137,0	148,4	182	228	262	285	400	514	571	800	868	1143	1257
kW	143,2	155,2	191	239	274	298	418	537	597	836	908	1195	1314
kW	–	–	221	277	318	346	433	546	606	692	866	–	–
A	100	110	120	135	180	200	280	360	400	550	600	800	875
kW	38,1	41,9	45	51	68	76	106	137	152	209	228	304	333
kW	39,8	43,8	47	53	71	79	111	143	159	219	239	318	348
kW	41,5	45,7	49	56	74	83	116	150	166	228	249	332	363
kW	65,7	72,3	78	88	118	131	184	237	263	362	395	526	575
kW	69,2	76,1	83	93	124	138	193	249	277	381	415	554	606
kW	71,8	79,0	86	97	129	143	201	259	287	395	431	575	628
kW	76,1	83,7	91	102	137	152	213	274	304	419	457	609	666
kW	86,5	95,2	103	116	155	173	242	312	346	476	519	692	757
kW	114,2	125,6	137	154	205	228	320	412	457	628	685	914	1000
kW	119,4	131,3	143	161	215	239	334	430	478	657	717	956	1045
kW	–	–	166	187	277	346	388	499	554	692	866	–	–
mm ²	50	50	70	95	95	120	240	2x150	2x(30x6)	2x(40x5)	2x(50x5)	2x(60x5)	2x(60x6)
A	63	74	90	115	150	175	210	260	315	450	550	700	860
A	62	74	90	115	150	175	210	260	315	450	550	700	860
A	62	74	90	115	150	175	210	260	315	450	550	700	860
A	62	74	90	115	150	175	210	260	315	450	550	700	860
A	62	74	90	115	150	175	210	260	315	450	550	700	860
A	62	74	90	115	150	175	210	260	315	450	550	700	860
A	42	42	60	60	150	175	210	260	315	450	550	700	860
A	40	40	58	58	120	140	150	180	240	400	500	630	700
A	–	–	58	58	60	70	85	100	125	200	250	–	–
kW	18,5	22	25	33	40	50	60	75	90	132	175	225	280
kW	19	23	27	35	45	55	65	80	100	140	185	235	290
kW	30	37	45	55	75	90	110	132	160	250	300	400	500
kW	33	40	49	63	80	95	115	140	180	257	315	415	515
kW	33	40	49	63	85	100	125	150	190	270	335	450	530
kW	37	45	55	55	90	100	132	160	210	300	375	500	600
kW	37	45	55	55	110	132	132	160	210	375	500	630	700
kW	–	–	55	55	75	90	110	132	160	280	355	–	–

Contactors

Data according to IEC 60947-4-1, EN 60947-4-1, VDE 0660

Main Contacts	Type	J7KN(G)-10(D)	J7KN(G)-14(D)	J7KN(G)-18(D)	J7KN(G)-22(D)	J7KN(G)-24	J7KN(G)-32	J7KN(G)-40	J7KN-50	
Utilization category AC4	220V A	12	15	18	18	24	30	40	50	
Switching of squirrel cage motors, inching	230V A	11,5	14,5	18	18	24	30	40	50	
Rated operational current I_e open and enclosed	240V A	11	14	18	18	24	32	40	50	
	380-400V A	10	14	18	18	24	32	40	50	
	415V A	9	14	18	18	23	30	37	45	
	440V A	9	14	18	18	23	30	37	45	
	500V A	9	12	16	16	17,5	21	21	33	
	660-V A	7	9	9	9	17	20	20	31	
	690V A	6,5	8,5	8,5	8,5	17	20	20	31	
	1000V A	—	—	—	—	—	—	—	—	
	Rated operational power of three-phase motors 50-60Hz	220-230V kW	3	4	5	5	6	8,5	11	12,5
		240V kW	3	4	5	5	7	9	11,5	13,5
380-400V kW		4	5,5	7,5	7,5	11	15	18,5	22	
415V kW		4,5	6	8,5	8,5	12	16	20	24	
440V kW		4,5	6	8,5	8,5	12	16	20	24	
500V kW		5,5	7,5	10	10	15	18,5	18,5	30	
660-690V kW		5,5	7,5	10	10	15	18,5	18,5	30	
1000V kW	—	—	—	—	—	—	—	—		
Utilization category AC5a										
Switching of gas discharge lamps										
Rated operational current I_e per pole at 220/230V										
Fluorescent lamps, uncompensated and serial compensated	A 20	20	25	25	40	52	64	88	96	
parallel compensated	A	7	9	9	9	18	22	22	30	
dual-connection	A	22,5	22,5	28	28	45	58	72	98	
Metal halide lamps ¹ , uncompensated	A	12	15	19	19	30	39	48	66	
parallel compensated	A	7	9	9	9	18	22	22	30	
Mercury-vapour lamps ² , uncompensated	A	22,5	25	28	28	45	58	72	99	
parallel compensated	A	7	9	9	9	18	22	22	30	
Mixed light lamps ³	A	20	20	25	25	40	52	64	88	
Utilization category AC5b										
Switching of incandescent lamps⁴										
Rated operational current I_e per pole at 220/230V	A	12,5	12,5	12,5	12,5	25	31	31	43	

¹ Metal halide lamps and sodium-vapour lamps (high- and low-pressure lamps)

² High-pressure lamps

³ Blended lamps, containing a mercury high-pressure unit and a tungsten helix in a fluorescent glass bulb (daylight lamps)

⁴ Current inrush approx. $16 \times I_e$

Contactors

Data according to IEC 60947-4-1, EN 60947-4-1, VDE 0660

Type	J7KN-62	J7KN-74	J7KN-90	J7KN-115	J7KN-151	J7KN-176	J7KN-210	J7KN-260	J7KN-316	J7KN-450	J7KN-550	J7KN-700	J7KN-860
A	63	63	85	98	55	63	85	100	120	150	180	230	280
A	62	62	85	98	55	63	85	100	120	150	180	230	280
A	62	62	85	98	55	63	85	100	120	150	180	230	280
A	62	62	85	85	55	63	85	100	120	150	180	230	280
A	60	60	85	85	55	63	85	100	120	150	180	230	280
A	55	55	85	85	55	63	85	100	120	150	180	230	280
A	42	42	85	85	—	—	—	—	—	—	—	—	—
A	40	40	60	60	—	—	—	—	—	—	—	—	—
A	40	40	57,5	57,5	—	—	—	—	—	—	—	—	—
A	—	—	—	—	—	—	—	—	—	—	—	—	—
kW	18,5	18,5	25	30	15	18,5	25	30	37	45	51	68	80
kW	19	19	27	32	15,5	19	26	31	38	47	53	71	83
kW	30	30	45	45	25	30	45	55	63	75	90	120	150
kW	33	33	49	49	25	33	45	55	65	80	100	132	160
kW	33	33	49	49	30	34	48	55	67	85	100	132	160
kW	37	37	55	55	25	30	55	65	75	100	110	150	185
kW	37	37	55	55	25	30	55	65	75	100	110	150	185
kW	—	—	—	—	—	—	—	—	—	—	—	—	—
A	104	—	100	120	120	140	180	220	280	360	450	570	700
A	40	45	55	70	85	100	130	160	200	300	360	460	550
A	108	117	112	144	120	140	180	220	280	360	450	570	700
A	72	78	85	90	95	110	140	180	230	300	380	490	610
A	40	45	55	70	75	85	110	140	170	260	300	400	480
A	108	117	112	144	120	140	180	220	280	360	450	570	700
A	40	45	55	70	75	85	110	140	170	260	300	400	480
A	96	104	100	120	100	120	160	200	250	320	400	500	600
A	56	56	69	75	100	120	160	190	220	260	315	440	500

Contactors

Data according to IEC 60947-4-1, EN 60947-4-1, VDE 0660

Main Contacts	Type	J7KN(G)-10(D)	J7KN(G)-14(D)	J7KN(G)-18(D)	J7KN(G)-22(D)	J7KN(G)-24	J7KN(G)-32	J7KN(G)-40	J7KN-50
Utilization category AC6a									
Transformer primary switching									
at inrush	n	30	30	30	30	30	30	30	30
Rated operational current I _e	400V A	4,5	5,5	7,5	7,5	10,5	13,5	13,5	20
Rated operational power	220-230V kVA	138	2,2	3	3	4,2	5,4	5,4	8
dependent on inrush n	200V kVA	1,9	2,3	3,1	3,1	4,3	5,6	5,6	8,3
	380-400V kVA	3,1	3,8	5,2	5,2	7,3	9,3	9,3	13,5
For different inrush-factors x	415-440V- kVA	3,4	4,2	5,7	5,7	8	10,2	10,2	15
use the following formula:	500V kVA	3,9	4,8	6,5	6,5	9	11,5	11,5	17
P _x =P _n ^{n/x}	660-690V kVA	5,4	6,5	9	9	12,5	16	16	24
Utilization category AC6b									
Switching of three-phase capacitors									
Maximum inrush current (peak value)		35	25	20	20	25	25	25	25
as multiple k of the capacitor rated current	k								
Rated operational I _e	500V A	8	12	15,5	15,5	23	32	32	45
Rated operational power (sinφ→1)	220-230V kVAr	3	4,5	6	6	8,5	12	12	17
	240V kVAr	3,5	5	6,5	6,5	9,5	13	13	18,5
	380-400V kVAr	5	7,5	10	10	15	20	20	29
For different multiples x	415-440V kVAr	5,5	8	11	11	16	22	22	32
use the following formula:	500V kVAr	7	10	13	13	20	26	26	39
P _x =P _k ^{k/x}	660-690V kVAr	7	10	13	13	20	26	26	40
Switching of reactive capacitor banks									
Rated operational current I _e	690V A	8	13	18	20	28	36	42	48
Rated operational power	220-230V kVAr	2,9	5	7	7,5	11	14	16	20
	240V kVAr	3,1	5,4	7	8	11	14	17	20
	380-400V kVAr	5	9	12,5	13	20	25	27,5	33,3
	415-440V kVAr	5,5	9,5	13	14	22	27	30	36
	500V kVAr	6	11	15	17	25	30	36	40
	660-690V kVAr	8	15	20	22	33	41	48	55
	750(850)V kVAr	–	–	–	–	–	–	–	–
Utilization category DC1									
Switching of resistive load									
Time constant L/R≤1ms		20	25	32	32	50	65	80	110
Rated operational current I _e	1 pole 24V A								
	60V A	20	25	32	32	50	65	80	110
	110V A	6	6	6	6	10	10	10	12
	220V A	0,8	0,8	0,8	0,8	1,4	1,4	1,4	1,4
	3 poles in series 24V A	20	25	32	32	50	65	8/0	110
	60V A	20	25	32	32	50	65	80	110
	110V A	20	25	32	32	50	65	80	110
	220V A	16	20	20	20	30	35	35	63
Utilization category DC3 and DC5									
Switching of shunt motors and series motors									
Time constant L/R≤15ms		20	25	32	32	50	65	80	110
Rated operational current I _e	1 pole 24V A								
	60V A	6	6	6	6	30	30	30	60
	110V A	1,2	1,2	1,2	1,2	1,8	1,8	1,8	1,8
	220V A	0,2	0,2	0,2	0,2	0,2	0,2	0,2	0,25
	3 poles in series 24V A	20	25	32	32	50	65	80	110
	60V A	20	25	32	32	40	40	40	80
	110V A	20	20	20	20	40	40	40	80
	220V A	2,5	2,5	2,5	2,5	4	4	4	5

Contactors

Data according to IEC 60947-4-1, EN 60947-4-1, VDE 0660

Type	J7KN-62	J7KN-74	J7KN-90	J7KN-115	J7KN-151	J7KN-176	J7KN-210	J7KN-260	J7KN-316	J7KN-450	J7KN-550	J7KN-700	J7KN-860
n	30	30	30	30	30	30	30	30	30	30	30	30	30
A	27	33	38	50	65	80	90	120	142	203	248	315	390
kVA	10,7	13	15	20	25	30	34	45	54	77	95	120	148
kVA	11,2	13,5	15,5	20,5	27	33	37	50	59	80	100	130	160
kVA	18,5	22,5	26	34	45	55	60	80	95	140	170	210	270
kVA	20,5	25	29	38	46	57	63	85	100	145	175	220	280
kVA	23	28	33	43	55	69	75	100	120	170	210	270	330
kVA	32	39	45	60	56	69	100	135	160	200	250	320	350
k	25	20	20	20	20	20	25	20	20	20	20	20	20
A	60	70	87	100	120	155	195	225	255	300	370	440	520
kVA _r	24	28	33	38	45	60	75	90	100	115	145	170	200
kVA _r	25	29	36	42	52	62	78	94	104	120	150	175	205
kVA _r	39	46	57	65	80	100	130	155	170	200	250	300	350
kVA _r	43	50	60	70	95	110	135	165	175	210	260	310	360
kVA _r	50	58	70	80	100	130	170	194	220	260	320	380	450
kVA _r	50	58	70	80	100	130	170	194	220	260	320	380	450
A	72	108 ¹	98	105	115	140	200	225	250	330	420	550	600
kVA _r	28	33	35	40	43	53	76	85	95	125	160	209	228
kVA _r	28	36	39	43	45	55	80	90	100	130	170	220	240
kVA _r	50	75 ¹	68	75	75	90	130	145	160	210	270	350	390
kVA _r	53	75 ¹	71	77	80	100	140	160	170	230	290	380	420
kVA _r	60	75	85	90	95	120	170	190	210	280	350	450	500
kVA _r	82	100	110	120	125	150	200	230	260	350	450	600	650
kVA _r	–	–	115	125	–	–	–	–	–	–	–	–	–
A	120	130	160	200	–	–	–	–	–	–	–	–	–
A	120	130	160	200	–	–	–	–	–	–	–	–	–
A	12	12	20	25	–	–	–	–	–	–	–	–	–
A	1,4	1,4	2	2,5	–	–	–	–	–	–	–	–	–
A	120	130	160	200	200	250	350	400	450	600	760	1000	1100
A	120	130	160	200	200	250	350	400	450	600	760	1000	1100
A	120	130	160	200	150	170	250	280	315	400	480	560	630
A	80	80	100	160	80	100	150	180	200	250	315	400	450
A	120	130	160	200	–	–	–	–	–	–	–	–	–
A	60	60	85	100	–	–	–	–	–	–	–	–	–
A	1,8	1,8	2	2,5	–	–	–	–	–	–	–	–	–
A	0,25	0,25	0,5	0,5	–	–	–	–	–	–	–	–	–
A	120	130	160	200	–	–	–	–	–	–	–	–	–
A	80	80	100	110	–	–	–	–	–	–	–	–	–
A	80	80	100	110	–	–	–	–	–	–	–	–	–
A	5	5	7	8	–	–	–	–	–	–	–	–	–

¹ Consider resistive load (I_{th}). See page 10.

Contactors







Data according to IEC 60947-4-1, EN 60947-4-1, VDE 0660

Main Contacts	Type	J7KN(G)-10(D)	J7KN(G)-14(D)	J7KN(G)-18(D)	J7KN(G)-22(D)	J7KN(G)-24	J7KN(G)-32	J7KN(G)-40	J7KN-50	J7KN-62	J7KN-74
Maximum ambient temperature											
Operation	open °C	-40 to +60 (+90)* ¹									
	enclosed °C	-40 to +40									
with thermal overload relay	open °C	-25 to +60									
	enclosed °C	-25 to +40									
Storage	°C	-50 to +90									
Short circuit protection											
for contactors without thermal overload relay											
Coordination-type "1" according to IEC 60947-4-1											
Contact welding without hazard of persons											
max. fuse size	gL (gG) A	63	63	63	63	80	80	80	160	160	160
Coordination-type "2" according to IEC 60947-4-1											
Light contact welding accepted											
max. fuse size	gL (gG) A	25	35	35	35	50	50	50	100	125	125
Contact welding not accepted											
max. fuse size	gL (gG) A	16	16	16	16	25	35	35	50	63	63
For contactors with thermal overload relay the device with the smaller admissible backup fuse (contactor or thermal overload relay) determines the fuse size.											
Cable cross-sections											
for contactors without thermal overload relay											
1 cable per clamp											
main connector											
	solid or stranded mm ²	 0,75-6				 1,5-25			 4-50		
	flexible mm ²	1-4				2,5-16			10-35		
	flexible with multicore cable end mm ²	0,75-4				1,5-16			6-35		
2 cables per clamp solid or stranded mm ²		6+(1-6) / 4+(0,75-4) 2,5+(0,75-2,5) / 1,5+(0,75-1,5)				16+(2,5-16) / 10+(4-16) 6+(4-16) / 4+(2,5-16)			50+4 / 35+6 / 25+(6-16) 16+(6-16) / 10+(6-16)		
flexible mm ²		6+(1,5-4) / 4+(1-4) 2,5+(0,75-2,5) / 1,5+(0,75-1,5)				16+(2,5-6) / 10+(4-10) 6+(4-16) / 4+(2,5-16)			50+(4-10) / 35+(4-16) 25+(4-25) / 16+(4-16)		
1 cable per clamp main connector		solid AWG 18-10 flexible AWG 18-10				16-10 14-4			12-10 10-0		
2 cables per clamp		solid AWG 10+(16-10) / 12+(18-12) 14+(18-14) / 16+(18-16) flexible AWG 10+(14-10) / 12+(18-12) 14+(18-14) / 16+(18-16)				10+(16-10) / 12+(18-12) 14+(18-14) / 16+(18-16) 4+(18-12) / 6+(18-8) 8+(18-8) / 10+(18-12)			10+(12-10) / 12+12 1+(12-10) / 2+(8-12) 3+(12-8) / 4+(10-6)		
Frequency of operations z											
Contactors without thermal overload relay											
	without load 1/h	10000				7000			7000		
	AC3, I _e 1/h	600				600			400		
	AC4, I _e 1/h	120				120			120		
	DC3, I _e 1/h	600				600			400		
Mechanical life											
AC operated	S x 10 ⁶	10				10			10		
DC operated	S x 10 ⁶	10				10			10		
DC solenoid operated (J7KNG)	S x 10 ⁶	50				50			-		
Short time current											
	10s-current A	96	120	144	176	184	240	296	450	504	592
	120s-current A	42	52	58	66	80	97	110	195	203	222
Power loss per pole at I _e /AC3 400V W											
contact resistance	mW	0,21	0,35	0,5	0,75	0,7	1,3	2	2,2	3,9	5,5
Resistance to shock acc. to IED 68-2-27											
Shock time 20ms sine-wave	NO g	10	10	10	10	8	8	8	8	8	8
	NC g	6	6	6	6	-	-	-	-	-	-

*¹ With reduced control voltage range 0,9 up to 1,0 x U_s and with reduced rated current I_e/AC1 according to I_e/AC3

Contactors

Data according to IEC 60947-4-1, EN 60947-4-1, VDE 0660

Type	J7KN-90	J7KN-115	J7KN-151	J7KN-176	J7KN-210	J7KN-260	J7KN-316	J7KN-450	J7KN-550	J7KN-700	J7KN-860
°C	-10 to +60(+90) ^{*1}		-25 to +55(+70) ^{*2}								
°C	-40 to +40		-25 to +40								
°C	-25 to +60		-25 to +55								
°C	-25 to +40		-25 to +40								
°C	-50 to +90		-55 to +80								
A	250	250	250	315	400	450	500	630	630	800	1000
A	160	200	200	250	315	400	400	500	560	—	—
A	100	125	160	200	250	315	—	—	—	—	—
mm ²			 busbar 18 x 4 screw M8		 busbar 25 x 6 screw M10			 busbar 30 x 5 screw M12	 busbar 40 x 6 screw M12	 busbar 50 x 8 screw M12	 busbar 50 x 8 screw M14
mm ²	top below 0,5-95 + 10-120										
mm ²	0,5-70 + 10-95										
AWG	top below 20-10 —										
AWG	20-2/0 8-2/0										
1/h	3000		1200			1200			1200		
1/h	300		—								
1/h	120		—								
1/h	300		—								
S x 10 ⁶	5		10			5			5		
S x 10 ⁶	5		10			5			5		
S x 10 ⁶	—		—								
A	680	880	1200	1400	1800	2200	2600	3600	4400	5600	6900
A	275	330	500	575	800	900	1000	1400	1750	2200	2600
W	4,8	7,9	9	11	88	11	14,9	26,3	33,3	49	59,2
mW	0,6	0,5	0,4	0,35	0,18	0,16	0,15	—	—	—	—
g	7	7	—	—	—	—	—	—	—	—	—
g	5	5	—	—	—	—	—	—	—	—	—

*1 With reduced control voltage range 0,9 up to 1,0 x U_s and with reduced rated current I_e/AC1 according to I_e/AC3

*2 With reduced control voltage range 1,0 x U_s and with reduced rated current I_e/AC1 according to I_e/AC3

Contactors

Data according to IEC 60947-4-1, EN 60947-4-1, VDE 0660

Auxiliary Contacts	Type	J7KN-10D/14D/18D/22D	J7KNG-10/14/18/22	J7KN(G)-24/32/40	J7KN-50/62/74
Rated insulation voltage U_i ^{*1}	V~	690		—	—
Thermal rated current I_{th} to 690V					
Ambient temperature	40°C A	10	16	—	—
	60°C A	6	12	—	—
Utilization category AC15					
Rated operational current I_e	220-240V A	3	12	—	—
	380-415V A	2	4	—	—
	440V A	1,6	4	—	—
	500V A	1,2	3	—	—
	660-690V A	0,6	1	—	—
Utilization category DC13					
Rated operational current I_e	60V A	3,5	8	—	—
	110V A	0,5	1	—	—
	220V A	0,1	0,1	—	—
Short circuit protection		For contactors with thermal overload relay the device with the smaller admissible control fuse (contactor or thermal overload relay) determines the fuse.			
Short-circuit current 1kA, contact welding not accepted					
max. fuse size	gL (gG) A	25		—	—
Control Circuit					
Power consumption of coils					
AC operated	inrush VA	33-45		90-115	140-165
	sealed VA	7-10		9-13	13-18
	W	2,6-3		2,7-4	5,4-7
DC operated	inrush W	75		140	200
double winding coil	sealed W	2		2	6
DC solenoid operated (J7KNG)	inrush W	3		4	—
	sealed W	3		4	—
Operation range of coils					
in multiples of control voltage U_s					
	AC operated	0,85-1,1		0,85-1,1	0,85-1,1
	DC operated	0,8-1,1		0,8-1,1	0,8-1,1
Switching time at control voltage $U_s \pm 10\%$ ^{*2, *3}					
AC operated	make time ms	8-16		10-25	12-28
	release time ms	5-13		8-15	8-15
	arc duration ms	10-15		10-15	10-15
DC operated	make time ms	8-12		10-20	12-23
	release time ms	8-13		10-15	10-18
	arc duration ms	10-15		10-15	10-15
DC solenoid operated (J7KNG)	make time ms	65-85		65-85	—
	release time ms	20-30 ^{*4}		20-30 ^{*4}	—
	arc duration ms	10-15		10-15	—
Cable cross-section					
Auxiliary connector	solid mm ²	0,75-6		—	—
	flexible mm ²	1-4		—	—
	flexible with multicore cable end mm ²	0,75-4		—	—
Magnet coil	solid mm ²	0,75-2,5		0,75-2,5	0,75-2,5
	flexible mm ²	0,5-2,5		0,5-2,5	0,5-2,5
	flexible with multicore end mm ²	0,5-1,5		0,5-1,5	0,5-1,5
Clamps per pole		2		2	2
Auxiliary connector	solid AWG	18-10		—	—
	flexible AWG	18-10		—	—
Magnet coil	solid AWG	14-12		14-12	14-12
	flexible AWG	18-12		18-12	18-12
Clamps per pole		2		2	2

^{*1} Suitable for: earthed-neutral systems, overvoltage category I to IV, pollution degree 3 (standard-industry): $U_{imp} = 8kV$.
Data for other conditions on request.

^{*2} Total breaking time = release time + arc duration

Contactors

Data according to IEC 60947-4-1, EN 60947-4-1, VDE 0660

Type	J7KN-90	J7KN-115	J7KN-151	J7KN-176	J7KN-210	J7KN-260	J7KN-316	J7KN-450	J7KN-550	J7KN-700	J7KN-860
V~	—	—	—	—	—	—	—	690	—	690	—
A	—	—	—	—	—	—	—	10	—	10	—
A	—	—	—	—	—	—	—	—	—	—	—
A	—	—	—	—	—	—	—	3	—	3	—
A	—	—	—	—	—	—	—	2	—	2	—
A	—	—	—	—	—	—	—	1,5	—	1,5	—
A	—	—	—	—	—	—	—	1,5	—	1,5	—
A	—	—	—	—	—	—	—	1	—	1	—
A	—	—	—	—	—	—	—	—	—	—	—
A	—	—	—	—	—	—	—	1	—	1	—
A	—	—	—	—	—	—	—	0,5	—	0,5	—
A	—	—	—	—	—	—	—	10	—	10	—
VA	190-280	350	360	—	800-950	1350-1600	—	—	—	—	—
VA	—	5	5	—	9-11	21-25	—	—	—	—	—
W	2,5-5	—	—	—	—	—	—	—	—	—	—
W	280	350	360	—	700-850	1300-1550	—	—	—	—	—
W	5	5	5	—	8-10	18-22	—	—	—	—	—
W	—	—	—	—	—	—	—	—	—	—	—
W	—	—	—	—	—	—	—	—	—	—	—
ms	0,85-1,1 0,8-1,1	0,85-1,1 0,85-1,1	0,85-1,1 0,85-1,1	—	0,85-1,1 0,85-1,1	—	—	0,85-1,1 0,85-1,1	—	—	—
ms	20-35	30-60	40-60	—	50-10	—	—	—	—	—	—
ms	35-50	30-80	15-45	—	150-200 / 500-1000 ^{*1}	—	—	—	—	—	—
ms	10-15	—	—	—	—	—	—	—	—	—	—
ms	20-35	30-60	40-60	—	—	—	—	—	—	—	—
ms	35-50	30-80	15-45	—	—	—	—	—	—	—	—
ms	10-15	—	—	—	—	—	—	—	—	—	—
ms	—	—	—	—	—	—	—	—	—	—	—
ms	—	—	—	—	—	—	—	—	—	—	—
ms	—	—	—	—	—	—	—	—	—	—	—
mm ²	0,75-2,5	—	—	—	0,75-2,5	—	—	0,75-2,5	—	—	—
mm ²	0,75-2,5	—	—	—	0,75-2,5	—	—	0,75-2,5	—	—	—
mm ²	0,5-1,5	—	—	—	—	—	—	—	—	—	—
mm ²	0,75-2,5	1-2,5	1-2,5	—	1-2,5	—	—	1-2,5	—	—	—
mm ²	0,5-2,5	1-2,5	1-2,5	—	1-2,5	—	—	1-2,5	—	—	—
mm ²	0,5-1,5	—	—	—	—	—	—	—	—	—	—
	2	2	2	—	2	—	—	2	—	—	—
AWG	14-12	—	—	—	16-12	—	—	16-12	—	—	—
AWG	18-12	—	—	—	16-12	—	—	16-12	—	—	—
AWG	14-12	16-12	16-12	—	16-12	—	—	16-12	—	—	—
AWG	18-12	16-12	16-12	—	16-12	—	—	16-12	—	—	—
	2	2	2	—	2	—	—	2	—	—	—

^{*3} Values for delay of the release time of the make contact and the make time of the break contact will be increased, if magnet coils are protected against voltage peaks (varistor, RC-unit, diode-unit)

^{*4} with built-in coil suppressor

Contactors for North America

Data according to UL508

Main Contacts (cULus)	Type	J7KN(G)-10(D)	J7KN(G)-14(D)	J7KN(G)-18(D)	J7KN(G)-22(D)	J7KN(G)-24	J7KN(G)-32	J7KN(G)-40	J7KN-50	J7KN-62
Rated operational current "General Use"	A	25	25	30	30	50	65	80	110	120
Motor DOL 3-pase at 60Hz										
Rated operational current	600V A	10	14	18	22	22	27	34	44	52
Rated operational power	110-120V hp	1½	2	2	3	5	5	7½	10	10
	200V hp	3	3	5	5	7½	10	10	15	20
	220-240V hp	3	3	7½	7½	10	10	15	20	25
	277V hp	3	5	7½	7½	7½	10	15	20	25
	380-415V hp	5	5	10	10	10	15	20	25	30
	440-480V hp	5	7½	10	15	15	20	25	30	40
	550-600V hp	7½	10	15	20	20	25	30	40	50
Motor DOL 1-pase at 60Hz										
Rated operational current	600V A	10	14	18	22	22	27	34	44	52
Rated operational power of AC motors at 60Hz (1ph)	110-120V hp	½	¾	1	1½	1½	2	3	3	5
	200V hp	1	1,5	2	3	3	5	7½	7½	10
	220-240V hp	1½	2	3	3	5	5	7½	10	15
	277V hp	2	3	3	5	5	7½	10	10	15
	380-415V hp	3	3	5	5	5	7½	10	15	20
	440-480V hp	3	5	5	7½	7½	10	15	20	25
	550-600V hp	3	5	7½	10	10	15	20	25	30
Motor DOL 3-pase according ANSI A17.5										
Rated operational current	600V A	—	—	—	—	15	22	—	27	37
Rated operational power of 3-phase motors for elevators (500.000 operations)	110-120V hp	—	—	—	—	2	3	—	3	5
	200V hp	—	—	—	—	3	5	—	7½	10
	220-240V hp	—	—	—	—	5	7½	—	7½	10
	440-480V hp	—	—	—	—	10	15	—	20	25
	550-600V hp	—	—	—	—	10	20	—	25	30
Rated current 2 series contacts	600V A	—	—	—	—	22	27	—	44	52
Fuse Class RK5/Short-circuit current	A/kA	45/5	50/5	70/5	90/5	90/5	125/5	175/5	200/5	250/5
Fuse Class T/Short-circuit current	A/kA	45/100	50/100	70/100	90/100	110/100	150/100	150/100	175/100	175/100
Rated voltage	V	600	600	600	600	600	600	600	600	600
Auxiliary Contacts (cULus)		A600	A600	A600	A600	—	—	—	—	—

Contactors for North America

Data according to UL508

Type	J7KN-74	J7KN-90	J7KN-115	J7KN-151	J7KN-176	J7KN-210	J7KN-260	J7KN-316	J7KN-450	J7KN-550	J7KN-700	J7KN-860
A	130	160	200	180	220	250	300	350	420	520	700	810
A	66	85	99	125	150				300	400	550	700
hp	10	15	30	—	—	—	—	—	—	—	—	—
hp	25	25	35	40	50	60	75	100	125	150	200	250
hp	30	35	40	50	60	75	100	125	125	150	250	300
hp	30	—	—	—	—	—	—	—	—	—	—	—
hp	40	50	60	—	—	—	—	—	—	—	—	—
hp	50	65	75	100	125	150	200	250	250	350	500	600
hp	50	85	100	125	150	200	250	300	250	350	500	600
A	66	86	103	125	150	—	—	—	—	—	—	—
hp	7½	8	10	15	25	—	—	—	—	—	—	—
hp	15	15	20	—	—	—	—	—	—	—	—	—
hp	15	20	25	25	30	40	50	50	—	—	—	—
hp	15	20	25	—	—	—	—	—	—	—	—	—
hp	20	30	40	—	—	—	—	—	—	—	—	—
hp	25	40	50	—	—	—	—	—	—	—	—	—
hp	30	50	60	—	—	—	—	—	—	—	—	—
A	—	—	—	—	—	—	—	—	—	—	—	—
hp	—	—	—	—	—	—	—	—	—	—	—	—
hp	—	—	—	—	—	—	—	—	—	—	—	—
hp	—	—	—	—	—	—	—	—	—	—	—	—
hp	—	—	—	—	—	—	—	—	—	—	—	—
hp	—	—	—	—	—	—	—	—	—	—	—	—
A	66	—	—	—	—	—	—	—	—	—	—	—
A/kA	300/5	300/10	300/10	300/10	350/10	400/18	500/18	500/18	1200/18	1200/18	2000/30	2000/30
A/kA	175/100	300/100 ^{*1}	300/100 ^{*1}	—	—	—	—	—	—	—	—	—
V	600	600	600	600	600	600	600	600	600	600	600	600
—	—	—	—	—	—	—	—	—	A600	A600	A600	A600

^{*1} Class T and Class RK1

Contactors

Data according to IEC 60947-4-1, EN 60947-4-1, VDE 0660

Contact Life

For selection of the suitable contactor-type according to supply voltage, power rating and application (utilization category AC1, AC3 or AC4) use contact life characteristic diagram.

For the most common supply voltages four scales of power ratings P_n are provided for each utilization category.

Select contactor-type according to utilization category **AC3** (breaking current $I_a = I_e$) using the **motor rating** scales to the right, according to utilization category **AC4** (breaking current $I_a = 6 \times I_e$) using the **motor rating** scales to the left.*1

Select contactor-type according to utilization category **AC1** (breaking current $I_a = I_e/AC1$) using the **breaking current** scale.*1

1. Pay attention to the approved rated values of the selected contactor according to the national approvals

For contactors frequently used under AC3/AC4-mixed service conditions calculate contact life with the formula:

$$M = \frac{AC3}{1 + \frac{\%AC4}{100} \times \left(\frac{AC3}{AC4} - 1\right)}$$

M = Contact life (switching cycles) for AC3/AC4-mixed operations

AC3 = Contact life (switching cycles) for AC3 operations (normal switching conditions). Breaking current $I_a =$ rated motor current I_n .

AC4 = Contact life (switching cycles) for AC4 operations (inching).

Breaking current $I_a =$ multiples of rated motor current I_n .

%AC4 = Percents of AC4-operations related to the total cycles.

Motor Rating $P_n/AC4$

660/ 500V 380/ 220/
690V 400V 230V

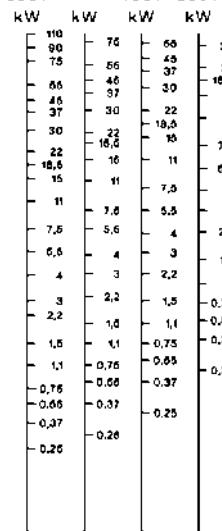

Motor Rating $P_n/AC3$

660/ 500V 380/ 220/
690V 400V 230V

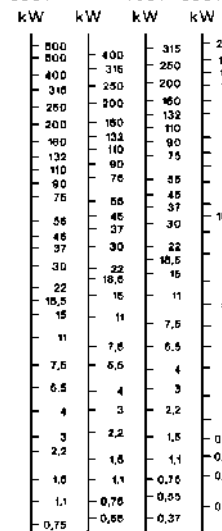

Breaking Current $I_a (=I_e/AC1)$

A

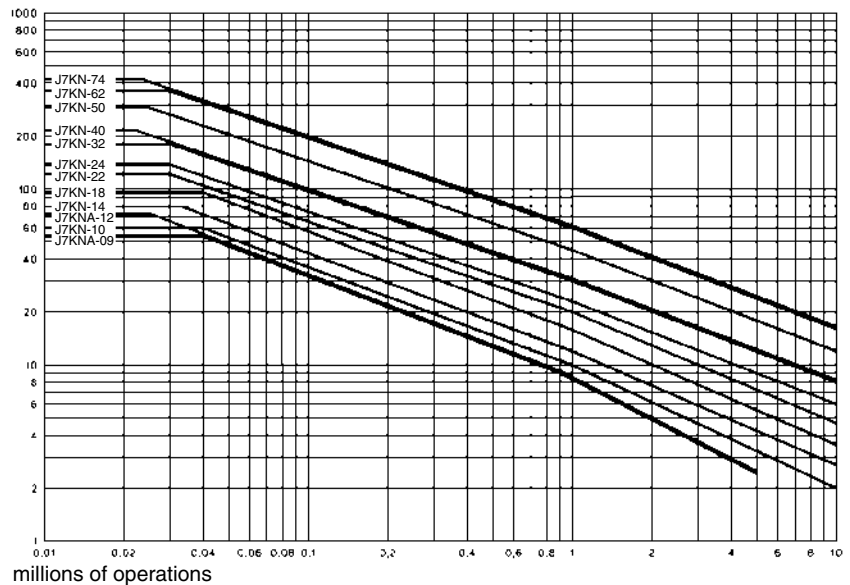

Motor Rating $P_n/AC4$

660/ 500V 380/ 220/
690V 400V 230V

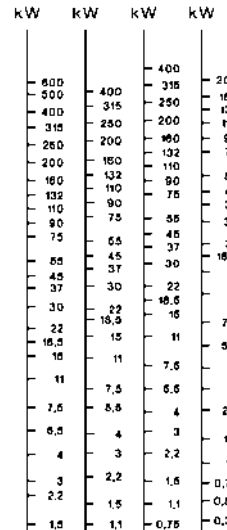

Motor Rating $P_n/AC3$

660/ 500V 380/ 220/
690V 400V 230V

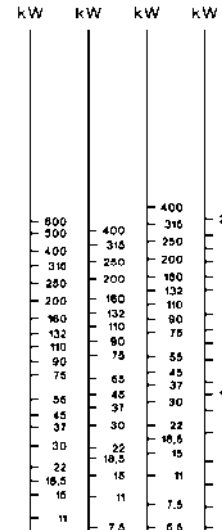

Breaking Current $I_a (=I_e/AC1)$

A

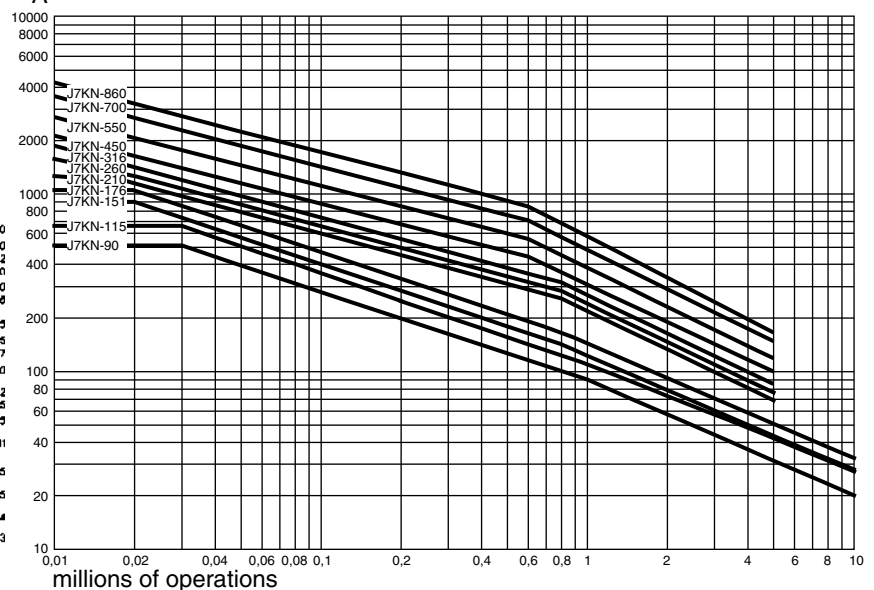

Contactors

Utilization Categories

For easier choice of devices and in order to make the comparison of different products simpler are utilization categories for contactors and motor-starters according to IEC 947-4-1 and VDE 0660 Part 102, for

control circuit devices and switching elements according to IEC 947-5-1 and VDE 0660 Part 200 determined. The table offers different utilization categories, typical applications and assorted test conditions.

Type of current	Category	Typical applications	Rated operational current	Test conditions for the number of on-load operating cycles						Test conditions for making and breaking capacities					
				Make I/le	U/Ur	cos	Break Ic/le	Ur/Ur	cos	Make I/le	U/Ur	cos	Break Ic/le	Ur/Ur	cos
Alternating Current	AC1	Non-inductive or slightly inductive loads-resistance furnaces	all values	1	1	0.95	1	1	0.95	1.5	1.05	0.8	1.5	1.05	0.8
	AC2	Slip-ring motors: starting, switching off	all values	2.5	1	0.65	2.5	1	0.65	4	1.05	0.65	4	1.05	0.65
	AC3	Squirrel-cage motors: starting, switching off motors during running	17A< le 17A	6	1	0.65	1	0.17	0.65	10	1.05	0.45	8	1.05	0.45
			le 100A	6	1	0.35	1	0.17	0.35	10	1.05	0.45	8	1.05	0.45
			le> 100A	6	1	0.35	1	0.17	0.35	10	1.05	0.35	8	1.05	0.35
	AC4	Squirrel-cage motors: starting, plugging, inching	17A< le 17A	6	1	0.65	6	1	0.65	12	1.05	0.45	10	1.05	0.45
			le 100A	6	1	0.35	6	1	0.35	12	1.05	0.45	10	1.05	0.45
			le> 100A	6	1	0.35	6	1	0.35	12	1.05	0.35	10	1.05	0.35
	AC5a	Switching of electric discharge lamp controls	all values	-	-	-	-	-	-	3	1.05	0.45	3	1.05	0.45
	AC5b	Switching of incandescent lamps	all values	-	-	-	-	-	-	1.5	1.05	1)	4	1.05	1)
	AC6a	Switching of transformers	le 100A	-	-	-	-	-	-	4.5	1.05	0.45	3.6	1.05	0.45
			le> 100A	-	-	-	-	-	-	4.5	1.05	0.35	3.6	1.05	0.35
	AC6b	Switching of capacitor banks	-	-	-	-	-	-	-	2)			2)		
	AC7a	Slightly inductive loads in household appliances and similar applications	all values	-	-	-	-	-	-	1.5	1.05	0.8	1.5	1.05	0.8
	AC7b	Motor loads for household applications	le 100A	-	-	-	-	-	-	8	1.05	0.45	6	1.05	0.45
le> 100A			-	-	-	-	-	-	8	1.05	0.35	6	1.05	0.35	
AC8a	Hermetic refrigerant compressor motor control with manual resetting of overload releases	le 100A	-	-	-	-	-	-	6	1.05	0.45	6	1.05	0.45	
		le> 100A	-	-	-	-	-	-	6	1.05	0.35	6	1.05	0.35	
AC8b	Hermetic refrigerant compressor motor control with automatic resetting of overload releases	le 100A	-	-	-	-	-	-	6	1.05	0.45	6	1.05	0.45	
		le> 100A	-	-	-	-	-	-	6	1.05	0.35	6	1.05	0.35	
AC12	Control of resistive loads and solid state loads with isolation by opto couplers	all values	-	-	-	-	-	-	1	1	0.9	1	1	0.9	
AC13	Control of solid state loads with transformer isolation	all values	-	-	-	-	-	-	10	1.1	0.65	1.1	1.1	0.65	
AC14	Control of small electromagnetic loads (<=72VA)	-	-	-	-	-	-	-	6	1.1	0.7	6	1.1	0.7	
AC15	Control of electromagnetic load (>72VA)	-	10	1	0.7	1	1	0.4	10	1.1	0.3	10	1.1	0.3	
				Make I/le	U/Ur	L/R [ms]	Break Ic/le	Ur/Ur	L/R [ms]	Make I/le	U/Ur	L/R [ms]	Break Ic/le	Ur/Ur	L/R [ms]
Direct Current	DC1	Non-inductive or slightly inductive loads resistance furnaces	all values	1	1	1	1	1	1	1.5	1.05	1	1.5	1.05	1
	DC3	Shunt-motors: starting, plugging, inching dynamic braking of d.c. motors	all values	2.5	1	2	2.5	1	2	4	1.05	2.5	4	1.05	2.5
	DC5	Series-motors: starting, plugging, inching dynamic braking of d.c. motors	all values	2.5	1	7.5	2.5	1	7.5	4	1.05	15	4	1.05	15
	DC6	Switching of incandescent lamps	all values	-	-	-	-	-	-	1.5	1.05	1)	4	1.05	1)
	DC12	Control of resistive loads and solid state loads with isolation by opto couplers	all values	-	-	-	-	-	-	1	1	1	1	1	1
	DC13	Control of electromagnets	all values	1	1	300	1	1	300	1.1	1.1	300	1.1	1.1	300
	DC14	Control of electromagnetic loads having economy resistors in circuit	all values	-	-	-	-	-	-	10	1.1	15	10	1.1	15

U_r Rated operational voltage, U Voltage before make, U_r Recovery voltage, I_r Rated operational current, I_m Current make, I_b Current broken

- 1) Test with incandescent lamps
- 2) Test conditions according to standard

Accessories

Data according to IEC 60947-4-1, EN 60947-5-1, VDE 0660

Auxiliary Contacts	Type	J73KN-B	J73KN-B...A	J73KN-C	J73KN-D	J74KN-B-TP...
Rated insulation voltage U_i^{*1}	V~	690	690	690	690	690
Thermal rated current I_{th} to 690V						
Ambient temperature	40°C A	10	25	10	10	10
	60°C A	6	20	6		-
Frequency of operations z	1/h	3000	3000	3000	3000	1200
Mechanical life	$S \times 10^6$	10	10	10	10	1
Power loss per pole at $I_g/AC1$	W	0,5	1,5	0,5	-	-
Utilization category AC15						
Rated operational current I_g	220-240V A	3	6	3	3	4
	380-400V A	2	3	2	2	3
	440V A	1,6	2	1,6	1,5	2
	500V A	1,2	2	1,2	1,5	2
	660-690V A	0,6	1	0,6	1	2
Utilization category DC13						
Rated operational current I_g	60V A	2	8	2	-	2,5
	110V A	0,4	1	0,4	1	1,5
	220V A	0,1	0,1	0,1	0,5	0,2
Short circuit protection						
short-circuit current 1kA, contact welding not accepted max. fuse size	gL (gG) A	20	25	20	10	10
For contactors with thermal overload relay or auxiliary contacts the device with the smaller admissible control fuse (contactor or thermal overload relay) determines the fuse size.						
Cable cross-sections						
	solid or stranded mm ²	0,75-2,5	0,75-2,5	0,75-2,5	0,75-2,5	1-2,5
	flexible mm ²	0,75-2,5	0,75-2,5	0,75-2,5	0,75-2,5	0,75-2,5
	flexible with multicore cable end mm ²	0,5-1,5	0,5-1,5	0,5-1,5	-	0,75-2,5
Cables per clamp		2	2	2	2	2

*1 Suitable for: earthed-neutral systems, overvoltage category I to IV, pollution degree 3 (standard-industry): $U_{imp} = 8kV$. Data for other conditions on request

Data according to CSA, UL and CUL

Auxiliary Contacts	Type	J73KN-B	J73KN-B...A	J73KN-C	J73KN-D	J74KN-B-TP...
Rated operational current „General Use“	A	10	16	10	10	10
Rated operational voltage	max. V AC	600	600	600	600	600
Auxiliary Contacts		A600	A600	A600	A600	A600

■ Dimensions / Position of Terminals

Contactors

	<p>J7KN-10D/14D/18D/22D(-4)...</p> 	<p>J7KN-10D-10 to J7KN-22D-10</p> 	<p>J7KN-10D-01 to J7KN-22D-01</p> 	<p>J7KN-10D-4_ to J7KN-22D-4_</p> 
	<p>J7KNG-10/14/18/22(-4)...D</p> 	<p>J7KNG-10-10...D J7KNG-14-10...D J7KNG-18-10...D J7KNG-22-10...D</p> 	<p>J7KNG-10-01...D J7KNG-14-01...D J7KNG-18-01...D J7KNG-22-01...D</p> 	<p>J7KNG-10-4_...D J7KNG-14-4_...D J7KNG-18-4_...D J7KNG-22-4_...D</p> 
	<p>J7KN-10D/14D/18D/22D...D</p> 	<p>J7KN-10D-10...D J7KN-14D-10...D J7KN-18D-10...D J7KN-22D-10...D</p> 	<p>J7KN-10D-01...D J7KN-14D-01...D J7KN-18D-01...D J7KN-22D-01...D</p> 	<p>J7KN-10D-4_...D J7KN-14D-4_...D J7KN-18D-4_...D J7KN-22D-4_...D</p> 
	<p>J7KN-24/32/40...</p> 	<p>J7KN-24 J7KN-32 J7KN-40</p> 		
	<p>J7KNG-24/32/40...D</p> 	<p>J7KNG-24...D J7KNG-32...D J7KNG-40...D</p> 		

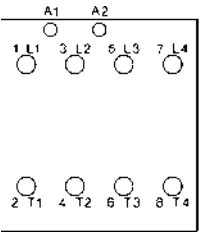
	<p>J7KN-24/32/40...D</p> 	<p>J7KN-24...D J7KN-32...D J7KN-40...D</p> 		
	<p>J7KN-50/62/74</p> 	<p>J7KN-50 J7KN-62 J7KN-74</p> 		
	<p>J7KN-50/62/74...D</p> 	<p>J7KN-50...D J7KN-62...D J7KN-74...D</p> 		
	<p>J7KN-90... J7KN-115...</p> 	<p>J7KN-90 J7KN-115</p> 	<p>J7KN-90...D J7KN-115...D</p> 	
	<p>J7KN-151... J7KN-176...</p> 	<p>J7KN-151 J7KN-176</p> 	<p>J7KN-151 J7KN-176</p> 	<p>J7KN-151 J7KN-176</p> 

	<p>J7KN-210... J7KN-260... J7KN-316...</p> 	<p>J7KN-210... J7KN-260... J7KN-316...</p> 	
	<p>J7KN-450... J7KN-550...</p> 	<p>J7KN-450... J7KN-550...</p> 	
	<p>J7KN-700... J7KN-860...</p> 	<p>J7KN-700... J7KN-860...</p> 	

Auxiliary contacts blocks



Pneumatic Timer



Mechanical Interlocks



Suppressor Units



Additional Terminals

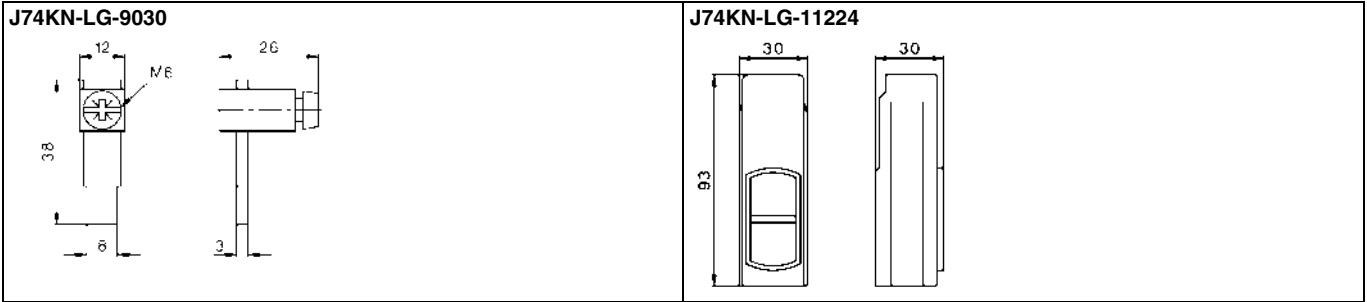

Terminals Cover

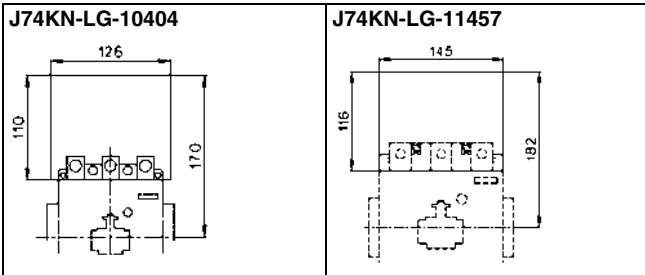

Marking Systems



Wiring Systems

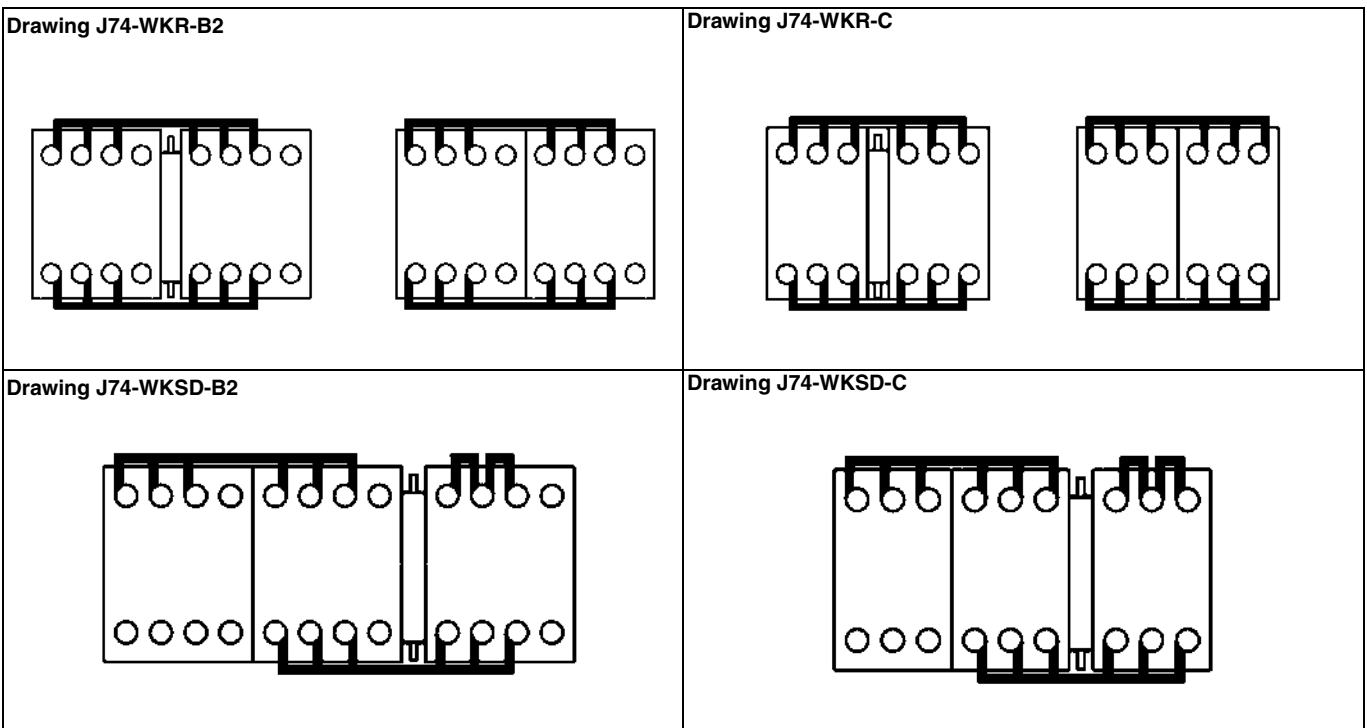

Do not use/install these products before having read the applicable precautions as listed in Cat. No. J09-EN-01 available from www.europe.omron.com or on request from OMRON local sales office.

ALL DIMENSIONS SHOWN ARE IN MILLIMETERS.

Компания «Океан Электроники» предлагает заключение долгосрочных отношений при поставках импортных электронных компонентов на взаимовыгодных условиях!

Наши преимущества:

- Поставка оригинальных импортных электронных компонентов напрямую с производств Америки, Европы и Азии, а так же с крупнейших складов мира;
- Широкая линейка поставок активных и пассивных импортных электронных компонентов (более 30 млн. наименований);
- Поставка сложных, дефицитных, либо снятых с производства позиций;
- Оперативные сроки поставки под заказ (от 5 рабочих дней);
- Экспресс доставка в любую точку России;
- Помощь Конструкторского Отдела и консультации квалифицированных инженеров;
- Техническая поддержка проекта, помощь в подборе аналогов, поставка прототипов;
- Поставка электронных компонентов под контролем ВП;
- Система менеджмента качества сертифицирована по Международному стандарту ISO 9001;
- При необходимости вся продукция военного и аэрокосмического назначения проходит испытания и сертификацию в лаборатории (по согласованию с заказчиком);
- Поставка специализированных компонентов военного и аэрокосмического уровня качества (Xilinx, Altera, Analog Devices, Intersil, Interpoint, Microsemi, Actel, Aeroflex, Peregrine, VPT, Syfer, Eurofarad, Texas Instruments, MS Kennedy, Miteq, Cobham, E2V, MA-COM, Hittite, Mini-Circuits, General Dynamics и др.);

Компания «Океан Электроники» является официальным дистрибьютором и эксклюзивным представителем в России одного из крупнейших производителей разъемов военного и аэрокосмического назначения «JONHON», а так же официальным дистрибьютором и эксклюзивным представителем в России производителя высокотехнологичных и надежных решений для передачи СВЧ сигналов «FORSTAR».



JONHON

«JONHON» (основан в 1970 г.)

Разъемы специального, военного и аэрокосмического назначения:

(Применяются в военной, авиационной, аэрокосмической, морской, железнодорожной, горно- и нефтедобывающей отраслях промышленности)

«FORSTAR» (основан в 1998 г.)

ВЧ соединители, коаксиальные кабели, кабельные сборки и микроволновые компоненты:

(Применяются в телекоммуникациях гражданского и специального назначения, в средствах связи, РЛС, а так же военной, авиационной и аэрокосмической отраслях промышленности).



Телефон: 8 (812) 309-75-97 (многоканальный)

Факс: 8 (812) 320-03-32

Электронная почта: ocean@oceanchips.ru

Web: <http://oceanchips.ru/>

Адрес: 198099, г. Санкт-Петербург, ул. Калинина, д. 2, корп. 4, лит. А