

Applications

- LTE Band 3 Uplink Infrastructure
- Base Station
- General Purpose Wireless



6 Pin 3 x 3 mm leadless SMT Package

Product Features

- 75 MHz Bandwidth
- High Attenuation
- Low Loss
- Single-ended Operation
- Small Size: 3 x 3 x 1.02 mm
- Surface Mount Device
- RoHS Compliant, Pb-Free

Functional Block Diagram

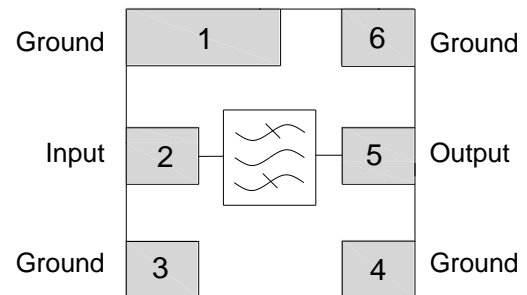

Top View

General Description

The TQQ7303 is an exceptionally high performance uplink BAW filter for LTE Band 3. This filter is housed in a compact 3x3 x 1.02 mm package for base station applications.

Low insertion loss, coupled with high attenuation makes this filter an ideal choice for uplink RF filtering needs.

The TQQ7303 is part of TriQuint's extensive portfolio of RF Baw and SAW filters.

Pin Configuration

Pin No.	Label
2	Input
5	Output
1,3,4,6	Case Ground

Ordering Information

Part No.	Description
TQQ7303	1747.5 MHz BAW Filter
TQQ7303-EVB	Evaluation board

Standard T/R size = 2500 pieces on a 7" reel

Absolute Maximum Ratings

Parameter	Rating
Storage Temperature	-40 to +95 °C
RF Input Power (CW, +55 °C for 10,000 hours)	+30 dBm
(CW, +105 °C for 100,000 hours)	+24 dBm

Operation of this device outside the parameter ranges given above may cause permanent damage.

Recommended Operating Conditions

Parameter	Min	Typ	Max	Units
T _{CASE}	-40		+85	°C

Electrical specifications are measured at specified test conditions.

Electrical Specifications (1,2,3)

Test conditions unless otherwise specified: Temp. +25 °C, Z_S=Z_L=50 Ohms

Parameter	Conditions	Min	Typ	Max	Units	
Pass Band Frequency		1710		1785		
Center Frequency		-	1747.5	-	MHz	
3.0 dB Bandwidth		-	81	-	MHz	
Insertion Loss	1710 – 1785 MHz	+25 °C	-	2.4	3.0	dB
		-40 °C to +85 °C	-	3.0	3.5	
Passband Ripple ⁽⁵⁾⁽⁶⁾	1710 – 1785 MHz	+25 °C	-	1.0	1.8	dB p-p
		-40 °C to +85 °C	-	1.6	2.4	
Group Delay Variation	1710 – 1785 MHz	+25 °C	-	20	40	ns p-p
		+25 °C to +85 °C	-	38	55	
Group Delay Variation	Any 5 MHz band in passband	+25 °C	-	7	18	ns p-p
		-40 °C to +85 °C	-	14	30	
Input/Output VSWR		-	1.9:1	2.4:1	ratio	
Stopband Attenuation (relative to zero dB)	0.9 – 720 MHz	30	32	-	dB	
	720 – 1670 MHz	28	32	-		
	1670 – 1690 MHz	10	20	-		
	1805 – 1825 MHz (-40 to -10 °C)	38	46	-		
	1825 – 1880 MHz	44	52	-		
	1880 – 1920 MHz	30	44	-		
	1920 – 2110 MHz	40	42	-		
	2110 – 2170 MHz	40	44	-		
	2170 – 2660 MHz	24	28	-		
	2660 – 2690 MHz	22	26	-		
2690 – 3800 MHz	10	17	-			
3800 – 5000 MHz	5	11	-			
Source/Load Impedance ⁽⁷⁾	Single ended	-	50	-	Ohms	

Notes:

- All specifications are based on the TriQuint schematic for the main reference design.
- Production test is performed at room temp. to a guard-banded specification to ensure electrical compliance over temperature.
- Electrical margin has been built into the design to account for variation due to temperature drift and manufacturing tolerances.
- Typical values are based on average measurements at room temperature of 25°C.
- This is defined as the difference between the maximum and minimum insertion loss within the specified band.
- This is defined as the worst difference between a peak and adjacent valley within defined frequency points.
- This is the optimum impedance in order to achieve the performance shown.

TQQ7303-PCB Evaluation Board

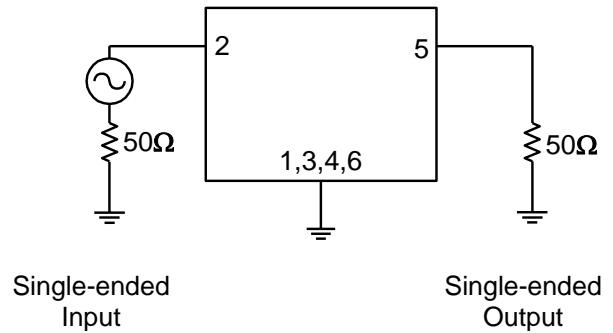
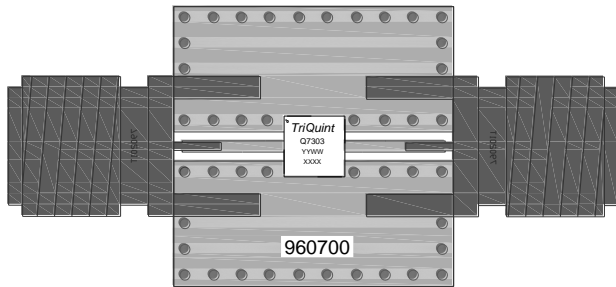

Evaluation Board PCB Information

Top, middle & bottom layers: 1 oz copper
 Substrates: FR4 dielectric, .031" thick
 Finish plating: Nickel: 3-8 μ m thick, Gold: .03-.2 μ m thick
 Hole plating: Copper min .0008 μ m thick

Performance Plots

Test conditions unless otherwise noted: Temp.= +25 °C

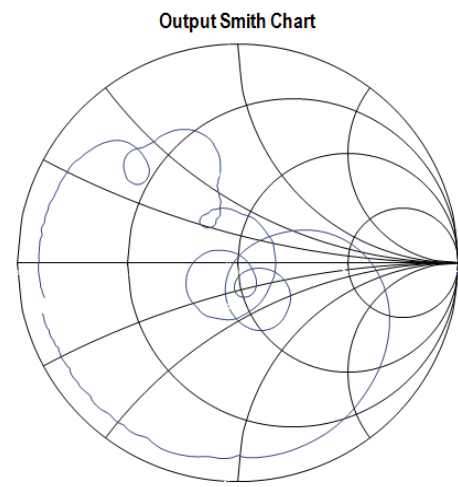
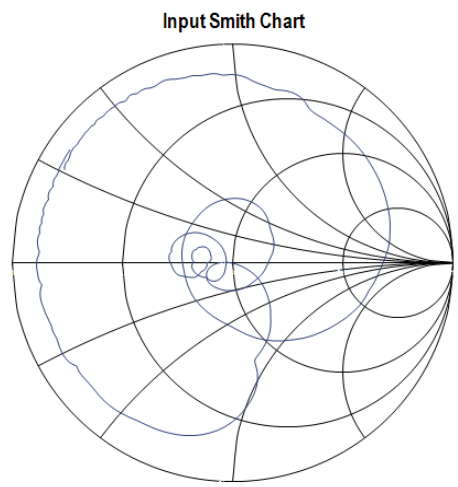
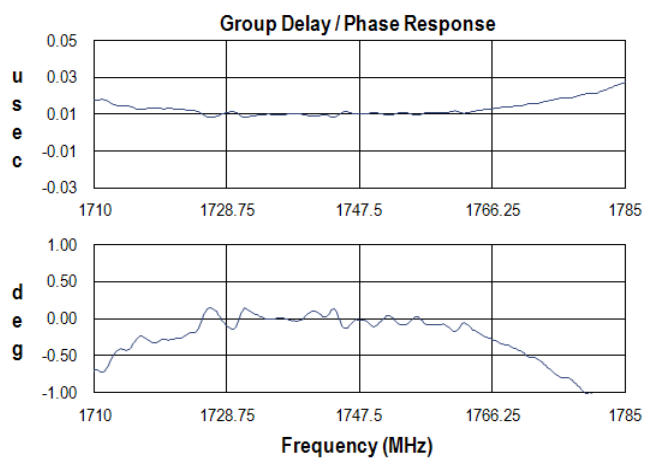
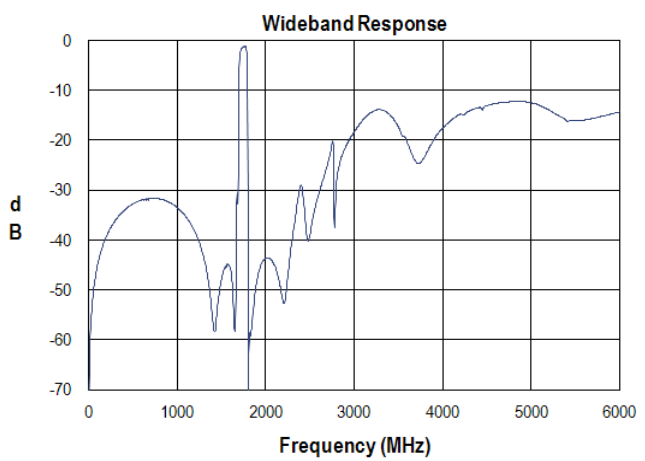
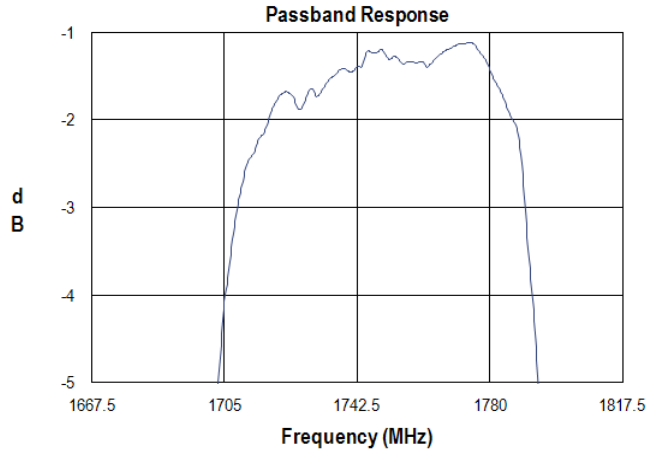
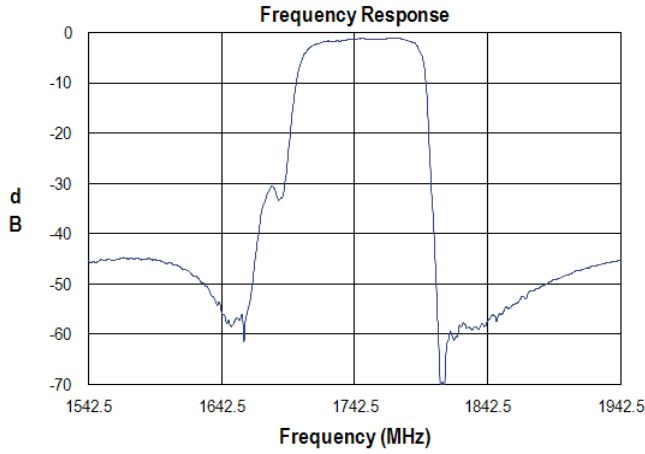

Package Marking and Dimensions

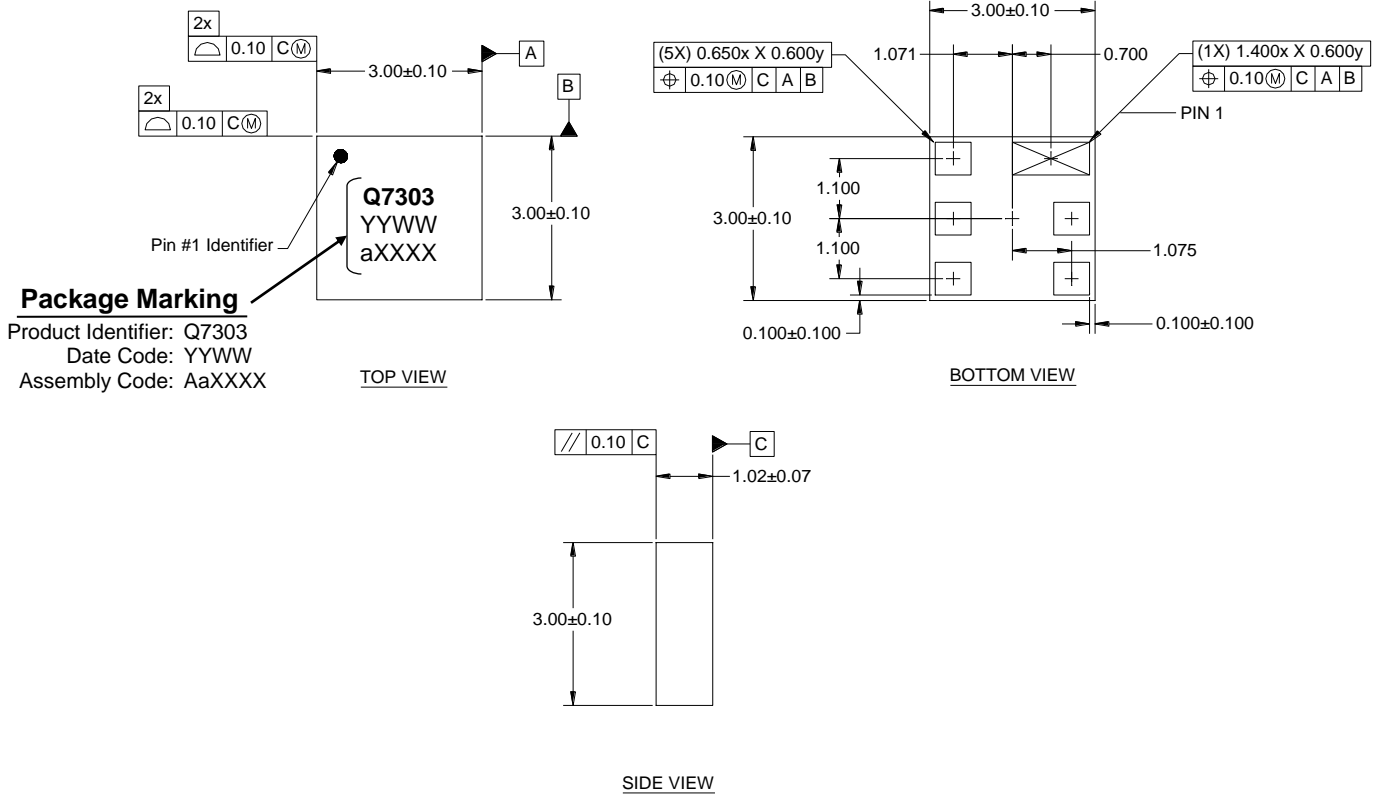

- Notes:
1. All dimensions are in millimeters
 2. All tolerances are ± 0.15 mm except overall length and width ± 0.10 mm
 3. Contact plating : ENIG (Electroless Nickel Immersion Gold)
 4. Terminations: $0.5 - 1.0 \mu\text{m}$ Au plating, over a $2 - 6 \mu\text{m}$ Ni plating

PCB Mounting Pattern

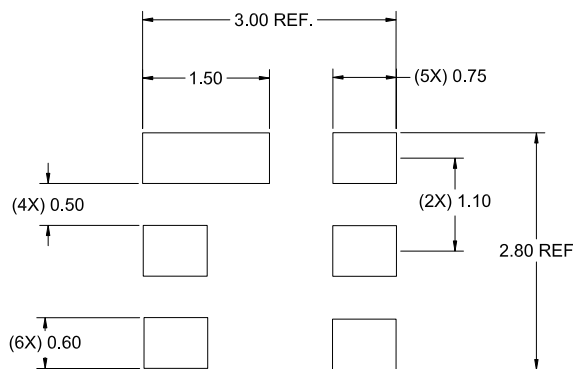

- Notes:
1. All dimensions are in millimeters. Angles are in degrees.
 2. Use 1 oz. copper minimum for top and bottom layer metal.

Tape and Reel Information – Carrier and Cover Tape Dimensions

Tape and reel specifications for this part are also available on the TriQuint website.
Standard T/R size = 2500 pieces on a 7" reel

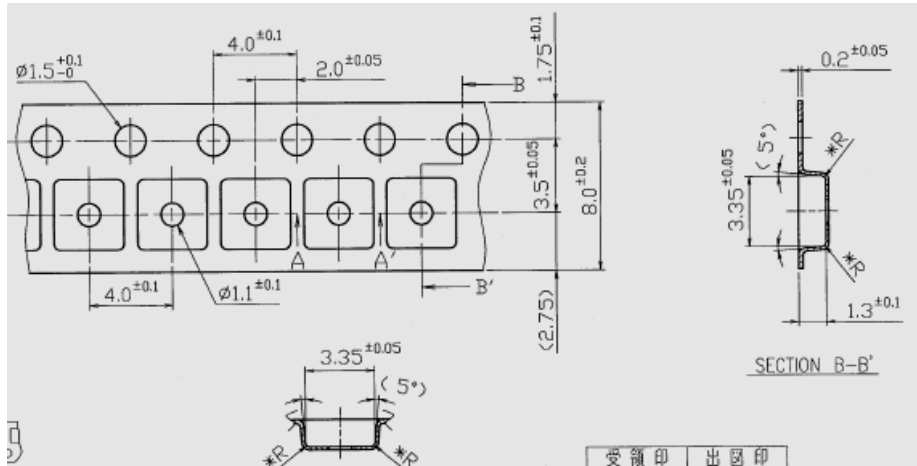

Feature	Measure	Symbol	Size (in)	Size (mm)
Cavity	Length	A0	0.132	3.35
	Width	B0	0.132	3.35
	Depth	K0	0.055	1.40
	Pitch	P1	0.157	4.00
Centerline Distance	Cavity to Perforation - Length Direction	P2	0.079	2.00
	Cavity to Perforation - Width Direction	F	0.138	3.50
Cover Tape	Width	C	0.213	5.40
Carrier Tape	Width	W	0.315	8.00

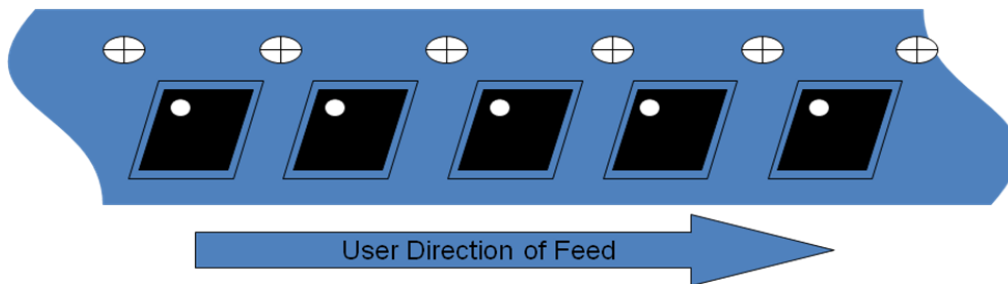

Tape and Reel Information – Reel Dimensions

Tape and reel specifications for this part are also available on the TriQuint website.
Standard T/R size = 2,500 pieces on a 7" reel.

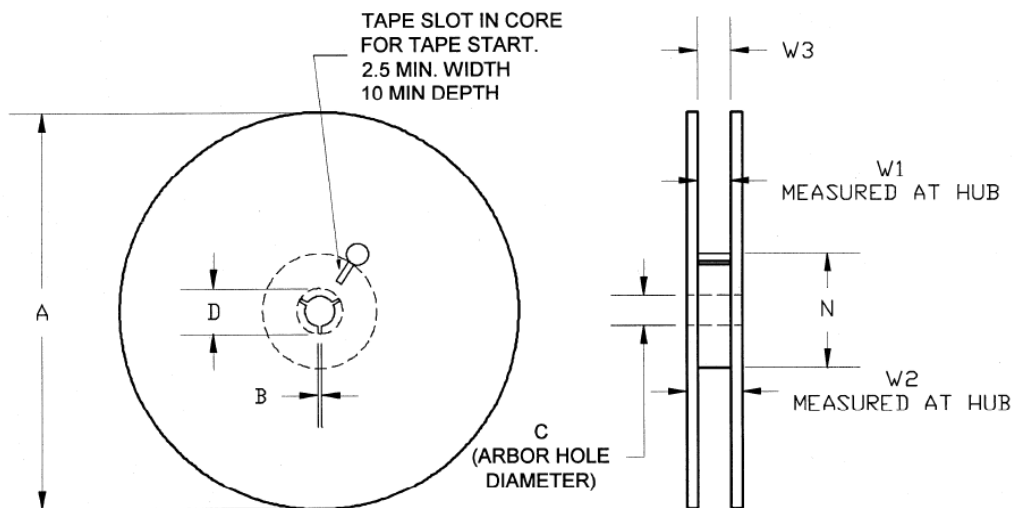

Feature	Measure	Symbol	Size (in)	Size (mm)
Flange	Diameter	A	6.969	177.0
	Thickness	W2	0.559	14.2
	Space Between Flange	W1	0.346	8.8
Hub	Outer Diameter	N	2.283	58.0
	Arbor Hole Diameter	C	0.512	13.0
	Key Slit Width	B	0.079	2.0
	Key Slit Diameter	D	0.787	20.0

Product Compliance Information

ESD Sensitivity Ratings



Caution! ESD-Sensitive Device

ESD Rating: Class 0B
Value: ≥ 125 V to < 250 V
Test: Human Body Model (HBM)
Standard: ESDA / JEDEC Standard JS-001-2012

ESD Rating: Class B
Value: > 200 V to < 400 V
Test: Machine Model (MM)
Standard: JEDEC Standard JESD22-A115F

MSL Rating

MSL Rating: Level 3
Test: 260 °C convection reflow
Standard: JEDEC Standard IPC/JEDEC J-STD-020

Solderability

Compatible with both lead-free (260°C maximum reflow temperature) and tin/lead (245°C maximum reflow temperature) soldering processes.

Contact plating: ENIG (Electroless Nickel Immersion Gold)

RoHS Compliance

This part is compliant with EU 2002/95/EC RoHS directive (Restrictions on the Use of Certain Hazardous Substances in Electrical and Electronic Equipment).

This product also has the following attributes:

- Lead Free
- Halogen Free (Chlorine, Bromine)
- Antimony Free
- TBBP-A (C₁₅H₁₂Br₄O₂) Free
- PFOS Free
- SVHC Free

Contact Information

For the latest specifications, additional product information, worldwide sales and distribution locations, and information about TriQuint:

Web: www.triquint.com **Tel:** +1.407.886.8860
Email: info-sales@triquint.com **Fax:** +1.407.886.7061

For technical questions and application information:

Email: sjcappliations.engineering@triquint.com

Important Notice

The information contained herein is believed to be reliable. TriQuint makes no warranties regarding the information contained herein. TriQuint assumes no responsibility or liability whatsoever for any of the information contained herein. TriQuint assumes no responsibility or liability whatsoever for the use of the information contained herein. The information contained herein is provided "AS IS, WHERE IS" and with all faults, and the entire risk associated with such information is entirely with the user. All information contained herein is subject to change without notice. Customers should obtain and verify the latest relevant information before placing orders for TriQuint products. The information contained herein or any use of such information does not grant, explicitly or implicitly, to any party any patent rights, licenses, or any other intellectual property rights, whether with regard to such information itself or anything described by such information.

TriQuint products are not warranted or authorized for use as critical components in medical, life-saving, or life-sustaining applications, or other applications where a failure would reasonably be expected to cause severe personal injury or death.

Компания «Океан Электроники» предлагает заключение долгосрочных отношений при поставках импортных электронных компонентов на взаимовыгодных условиях!

Наши преимущества:

- Поставка оригинальных импортных электронных компонентов напрямую с производств Америки, Европы и Азии, а так же с крупнейших складов мира;
- Широкая линейка поставок активных и пассивных импортных электронных компонентов (более 30 млн. наименований);
- Поставка сложных, дефицитных, либо снятых с производства позиций;
- Оперативные сроки поставки под заказ (от 5 рабочих дней);
- Экспресс доставка в любую точку России;
- Помощь Конструкторского Отдела и консультации квалифицированных инженеров;
- Техническая поддержка проекта, помощь в подборе аналогов, поставка прототипов;
- Поставка электронных компонентов под контролем ВП;
- Система менеджмента качества сертифицирована по Международному стандарту ISO 9001;
- При необходимости вся продукция военного и аэрокосмического назначения проходит испытания и сертификацию в лаборатории (по согласованию с заказчиком);
- Поставка специализированных компонентов военного и аэрокосмического уровня качества (Xilinx, Altera, Analog Devices, Intersil, Interpoint, Microsemi, Actel, Aeroflex, Peregrine, VPT, Syfer, Eurofarad, Texas Instruments, MS Kennedy, Miteq, Cobham, E2V, MA-COM, Hittite, Mini-Circuits, General Dynamics и др.);

Компания «Океан Электроники» является официальным дистрибьютором и эксклюзивным представителем в России одного из крупнейших производителей разъемов военного и аэрокосмического назначения «JONHON», а так же официальным дистрибьютором и эксклюзивным представителем в России производителя высокотехнологичных и надежных решений для передачи СВЧ сигналов «FORSTAR».



JONHON

«JONHON» (основан в 1970 г.)

Разъемы специального, военного и аэрокосмического назначения:

(Применяются в военной, авиационной, аэрокосмической, морской, железнодорожной, горно- и нефтедобывающей отраслях промышленности)

«FORSTAR» (основан в 1998 г.)

ВЧ соединители, коаксиальные кабели, кабельные сборки и микроволновые компоненты:

(Применяются в телекоммуникациях гражданского и специального назначения, в средствах связи, РЛС, а так же военной, авиационной и аэрокосмической отраслях промышленности).



Телефон: 8 (812) 309-75-97 (многоканальный)

Факс: 8 (812) 320-03-32

Электронная почта: ocean@oceanchips.ru

Web: <http://oceanchips.ru/>

Адрес: 198099, г. Санкт-Петербург, ул. Калинина, д. 2, корп. 4, лит. А