



Low-Cost, 315MHz and 433.92MHz ASK Transceiver with Fractional-N PLL

MAX7030

General Description

The MAX7030 crystal-based, fractional-N transceiver is designed to transmit and receive ASK/OOK data at factory-preset carrier frequencies of 315MHz or 433.92MHz with data rates up to 33kbps (Manchester encoded) or 66kbps (NRZ encoded). This device generates a typical output power of +10dBm into a 50Ω load and exhibits typical sensitivity of -114dBm. The MAX7030 features separate transmit and receive pins (PAOUT and LNAIN) and provides an internal RF switch that can be used to connect the transmit and receive pins to a common antenna.

The MAX7030 transmit frequency is generated by a 16-bit, fractional-N, phase-locked loop (PLL), while the receiver's local oscillator (LO) is generated by an integer-N PLL. This hybrid architecture eliminates the need for separate transmit and receive crystal reference oscillators because the fractional-N PLL is preset to be 10.7MHz above the receive LO. Retaining the fixed-N PLL for the receiver avoids the higher current-drain requirements of a fractional-N PLL and keeps the receiver current drain as low as possible. All frequency-generation components are integrated on-chip, and only a crystal, a 10.7MHz IF filter, and a few discrete components are required to implement a complete antenna/digital data solution.

The MAX7030 is available in a small, 5mm x 5mm, 32-pin thin QFN package, and is specified to operate over the automotive -40°C to +125°C temperature range.

Applications

2-Way Remote Keyless Entry
Security Systems
Home Automation
Remote Controls
Remote Sensing
Smoke Alarms
Garage Door Openers
Local Telemetry Systems

Pin Configuration, Typical Application Circuit, and Functional Diagram appear at end of data sheet.

Features

- ◆ +2.1V to +3.6V or +4.5V to +5.5V Single-Supply Operation
- ◆ Single-Crystal Transceiver
- ◆ Factory-Preset Frequency (No Serial Interface Required)
- ◆ ASK/OOK Modulation
- ◆ +10dBm Output Power into 50Ω Load
- ◆ Integrated TX/RX Switch
- ◆ Integrated Transmit and Receive PLL, VCO, and Loop Filter
- ◆ > 45dB Image Rejection
- ◆ Typical RF Sensitivity*: -114dBm
- ◆ Selectable IF Bandwidth with External Filter
- ◆ < 12.5mA Transmit-Mode Current
- ◆ < 6.7mA Receive-Mode Current
- ◆ < 800nA Shutdown Current
- ◆ Fast-On Startup Feature, < 250μs
- ◆ Small, 32-Pin, Thin QFN Package

*0.2% BER, 4kbps Manchester-encoded data, 280kHz IF BW

Ordering Information

PART	TEMP RANGE	PIN-PACKAGE
MAX7030_ATJ+	-40°C to +125°C	32 Thin QFN-EP**

+Denotes a lead(Pb)-free/RoHS-compliant package.

**EP = Exposed pad.

Note: The MAX7030 is available with factory-preset operating frequencies. See the Product Selector Guide for complete part numbers.

Product Selector Guide

PART	CARRIER FREQUENCY (MHz)
MAX7030LATJ+	315
MAX7030HATJ+	433.92

Low-Cost, 315MHz and 433.92MHz ASK Transceiver with Fractional-N PLL

ABSOLUTE MAXIMUM RATINGS

HVIN to GND-0.3V to +6.0V
 PAVDD, AVDD, DVDD to GND-0.3V to +4.0V
 ENABLE, T/R, DATA, AGC0, AGC1,
 AGC2 to GND-0.3V to (V_{HVIN}+ 0.3V)
 All Other Pins to GND-0.3V to (V_{VDD} + 0.3V)

Continuous Power Dissipation (T_A = +70°C)
 32-Pin Thin QFN (derate 21.3mW/°C
 above +70°C).....1702mW
 Operating Temperature Range-40°C to +125°C
 Storage Temperature Range-65°C to +150°C
 Lead Temperature (soldering, 10s)+300°C
 Soldering Temperature (reflow)+260°C

Stresses beyond those listed under "Absolute Maximum Ratings" may cause permanent damage to the device. These are stress ratings only, and functional operation of the device at these or any other conditions beyond those indicated in the operational sections of the specifications is not implied. Exposure to absolute maximum rating conditions for extended periods may affect device reliability.

DC ELECTRICAL CHARACTERISTICS

(Typical Application Circuit, 50Ω system impedance, V_{AVDD} = V_{DVDD} = V_{HVIN} = V_{PAVDD} = +2.1V to +3.6V, f_{RF} = 315MHz or 433.92MHz, T_A = -40°C to +125°C, unless otherwise noted. Typical values are at V_{AVDD} = V_{DVDD} = V_{HVIN} = V_{PAVDD} = +2.7V, T_A = +25°C, unless otherwise noted.) (Note 1)

PARAMETER	SYMBOL	CONDITIONS	MIN	TYP	MAX	UNITS
Supply Voltage (3V Mode)	V _{DD}	HVIN, PAVDD, AVDD, and DVDD connected to power supply	2.1	2.7	3.6	V
Supply Voltage (5V Mode)	HVIN	PAVDD, AVDD, and DVDD unconnected from HVIN, but connected together	4.5	5.0	5.5	V
Supply Current	I _{DD}	Transmit mode, PA off, V _{DATA} at 0% duty cycle (Note 2)	f _{RF} = 315MHz	3.5	5.4	mA
			f _{RF} = 434MHz	4.3	6.7	
		Transmit mode, V _{DATA} at 50% duty cycle (Notes 3, 4)	f _{RF} = 315MHz	7.6	12.3	
			f _{RF} = 434MHz	8.4	13.6	
		Transmit mode, V _{DATA} at 100% duty cycle (Note 2)	f _{RF} = 315MHz	11.6	19.1	
			f _{RF} = 434MHz	12.4	20.4	
		T _A < +85°C, typ at +25°C (Note 4)	Receiver 315MHz	6.1	7.9	μA
			Receiver 434MHz	6.4	8.3	
			Deep-sleep (3V mode)	0.8	8.8	
		T _A < +125°C, typ at +125°C (Note 2)	Deep-sleep (5V mode)	2.4	10.9	μA
			Receiver 315MHz	6.4	8.2	
			Receiver 434MHz	6.7	8.4	
Deep-sleep (3V mode)	8.0		34.2			
		Deep-sleep (5V mode)	14.9	39.3		
Voltage Regulator	V _{REG}	V _{HVIN} = 5V, I _{LOAD} = 15mA		3.0		V
DIGITAL I/O						
Input-High Threshold	V _{IH}	(Note 2)	0.9 x			V
Input-Low Threshold	V _{IL}	(Note 2)			0.1 x	V
					V _{HVIN}	

Low-Cost, 315MHz and 433.92MHz ASK Transceiver with Fractional-N PLL

MAX7030

DC ELECTRICAL CHARACTERISTICS (continued)

(Typical Application Circuit, 50Ω system impedance, $V_{AVDD} = V_{DVDD} = V_{HVIN} = V_{PAVDD} = +2.1V$ to $+3.6V$, $f_{RF} = 315MHz$ or $433.92MHz$, $T_A = -40^{\circ}C$ to $+125^{\circ}C$, unless otherwise noted. Typical values are at $V_{AVDD} = V_{DVDD} = V_{HVIN} = V_{PAVDD} = +2.7V$, $T_A = +25^{\circ}C$, unless otherwise noted.) (Note 1)

PARAMETER	SYMBOL	CONDITIONS	MIN	TYP	MAX	UNITS
Pulldown Sink Current		AGC0-2, ENABLE, T/\bar{R} , DATA ($V_{HVIN} = 5.5V$)		20		μA
Output-Low Voltage	V_{OL}	$I_{SINK} = 500\mu A$		0.15		V
Output-High Voltage	V_{OH}	$I_{SOURCE} = 500\mu A$		$V_{HVIN} - 0.26$		V

AC ELECTRICAL CHARACTERISTICS

(Typical Application Circuit, 50Ω system impedance, $V_{PAVDD} = V_{AVDD} = V_{DVDD} = V_{HVIN} = +2.1V$ to $+3.6V$, $f_{RF} = 315MHz$ or $433.92MHz$, $T_A = -40^{\circ}C$ to $+125^{\circ}C$, unless otherwise noted. Typical values are at $V_{PAVDD} = V_{AVDD} = V_{DVDD} = V_{HVIN} = +2.7V$, $T_A = +25^{\circ}C$, unless otherwise noted.) (Note 1)

PARAMETER	SYMBOL	CONDITIONS	MIN	TYP	MAX	UNITS
GENERAL CHARACTERISTICS						
Frequency Range				315/433.92		MHz
Maximum Input Level	PR_{FIN}			0		dBm
Transmit Efficiency 100% Duty Cycle		$f_{RF} = 315MHz$ (Note 6)		32		%
		$f_{RF} = 434MHz$ (Note 6)		30		
Transmit Efficiency 50% Duty Cycle		$f_{RF} = 315MHz$ (Note 6)		24		%
		$f_{RF} = 434MHz$ (Note 6)		22		
Power-On Time	t_{ON}	ENABLE or T/\bar{R} transition low to high, transmitter frequency settled to within 50kHz of the desired carrier		200		μs
		ENABLE or T/\bar{R} transition low to high, transmitter frequency settled to within 5kHz of the desired carrier		350		
		ENABLE transition low to high, or T/\bar{R} transition high to low, receiver startup time (Note 5)		250		
RECEIVER						
Sensitivity		0.2% BER, 4kbps Manchester data rate, 280kHz IF BW, average RF power	315MHz		-114	dBm
			434MHz		-113	
Image Rejection				46		dB
POWER AMPLIFIER						
Output Power	P_{OUT}	$T_A = +25^{\circ}C$ (Note 4)	4.6	10.0	15.5	dBm
		$T_A = +125^{\circ}C$, $V_{PAVDD} = V_{AVDD} = V_{DVDD} = V_{HVIN} = +2.1V$ (Note 2)	3.9	6.7		
		$T_A = -40^{\circ}C$, $V_{PAVDD} = V_{AVDD} = V_{DVDD} = V_{HVIN} = +3.6V$ (Note 4)		13.1	15.8	
Modulation Depth				82		dB
Maximum Carrier Harmonics		With output-matching network		-40		dBc
Reference Spur				-50		dBc

Low-Cost, 315MHz and 433.92MHz ASK Transceiver with Fractional-N PLL

AC ELECTRICAL CHARACTERISTICS (continued)

(Typical Application Circuit, 50Ω system impedance, $V_{PAVDD} = V_{AVDD} = V_{DVDD} = V_{HVIN} = +2.1V$ to $+3.6V$, $f_{RF} = 315MHz$ or $433.92MHz$, $T_A = -40^{\circ}C$ to $+125^{\circ}C$, unless otherwise noted. Typical values are at $V_{PAVDD} = V_{AVDD} = V_{DVDD} = V_{HVIN} = +2.7V$, $T_A = +25^{\circ}C$, unless otherwise noted.) (Note 1)

PARAMETER	SYMBOL	CONDITIONS		MIN	TYP	MAX	UNITS
PHASE-LOCKED LOOP							
Transmit VCO Gain	K_{VCO}				340		MHz/V
Transmit PLL Phase Noise		10kHz offset, 200kHz loop BW			-68		dBc/Hz
		1MHz offset, 200kHz loop BW			-98		
Receive VCO Gain					340		MHz/V
Receive PLL Phase Noise		10kHz offset, 500kHz loop BW			-80		dBc/Hz
		1MHz offset, 500kHz loop BW			-90		
Loop Bandwidth		Transmit PLL			200		kHz
		Receive PLL			500		
Reference Frequency Input Level					0.5		V _{P-P}
LOW-NOISE AMPLIFIER/MIXER (Note 8)							
LNA Input Impedance	Z_{INLNA}	Normalized to 50Ω	$f_{RF} = 315MHz$	1 - j4.7			
			$f_{RF} = 434MHz$	1 - j3.3			
Voltage-Conversion Gain		High-gain state	$f_{RF} = 315MHz$	50		dB	
			$f_{RF} = 434MHz$	45			
		Low-gain state	$f_{RF} = 315MHz$	13			
			$f_{RF} = 434MHz$	9			
Input-Referred, 3rd-Order Intercept Point	IIP3	High-gain state		-42		dBm	
		Low-gain state		-6			
Mixer-Output Impedance					330		Ω
LO Signal Feedthrough to Antenna					-100		dBm
RSSI							
Input Impedance					330		Ω
Operating Frequency	f_{IF}				10.7		MHz
3dB Bandwidth					10		MHz
Gain					15		mV/dB
ANALOG BASEBAND							
Maximum Data-Filter Bandwidth					50		kHz
Maximum Data-Slicer Bandwidth					100		kHz
Maximum Peak-Detector Bandwidth					50		kHz
Maximum Data Rate		Manchester coded			33		kbps
		Nonreturn to zero (NRZ)			66		

Low-Cost, 315MHz and 433.92MHz ASK Transceiver with Fractional-N PLL

MAX7030

AC ELECTRICAL CHARACTERISTICS (continued)

(Typical Application Circuit, 50Ω system impedance, $V_{PAVDD} = V_{AVDD} = V_{DVDD} = V_{HVIN} = +2.1V$ to $+3.6V$, $f_{RF} = 315MHz$ or $433.92MHz$, $T_A = -40^{\circ}C$ to $+125^{\circ}C$, unless otherwise noted. Typical values are at $V_{PAVDD} = V_{AVDD} = V_{DVDD} = V_{HVIN} = +2.7V$, $T_A = +25^{\circ}C$, unless otherwise noted.) (Note 1)

PARAMETER	SYMBOL	CONDITIONS	MIN	TYP	MAX	UNITS
CRYSTAL OSCILLATOR						
Crystal Frequency	f_{XTAL}			$(f_{RF} - 10.7) / 24$		MHz
Frequency Pulling by V_{DD}				2		ppm/V
Crystal Load Capacitance		(Note 7)		4.5		pF

- Note 1:** Supply current, output power, and efficiency are greatly dependent on board layout and PAOUT match.
- Note 2:** 100% tested at $T_A = +125^{\circ}C$. Guaranteed by design and characterization overtemperature.
- Note 3:** 50% duty cycle at 10kHz ASK data (Manchester coded).
- Note 4:** Guaranteed by design and characterization. Not production tested.
- Note 5:** Time for final signal detection; does not include baseband filter settling.
- Note 6:** Efficiency = $P_{OUT} / (V_{DD} \times I_{DD})$.
- Note 7:** Dependent on PCB trace capacitance.
- Note 8:** Input impedance is measured at the LNAIN pin. Note that the impedance at 315MHz includes the 12nH inductive degeneration from the LNA source to ground. The impedance at 434MHz includes a 10nH inductive degeneration connected from the LNA source to ground. The equivalent input circuit is 50Ω in series with ~2.2pF. The voltage conversion is measured with the LNA input-matching inductor, the degeneration inductor, and the LNA/mixer tank in place, and does not include the IF filter insertion loss.

Typical Operating Characteristics

(Typical Application Circuit, $V_{PAVDD} = V_{AVDD} = V_{DVDD} = V_{HVIN} = +3.0V$, $f_{RF} = 433.92MHz$, IF BW = 280kHz, 4kbps Manchester encoded, 0.2% BER, $T_A = +25^{\circ}C$, unless otherwise noted.)

RECEIVER

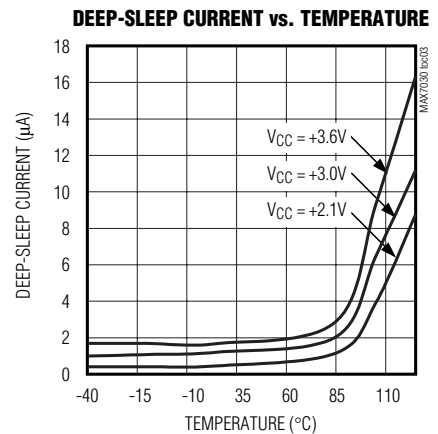
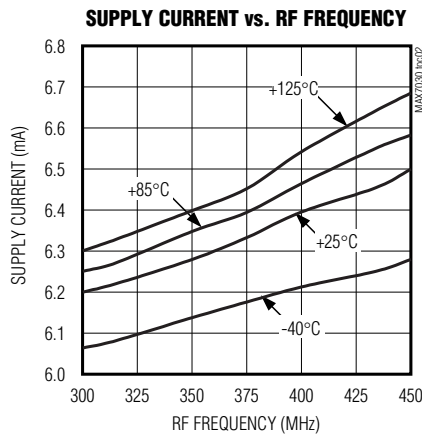
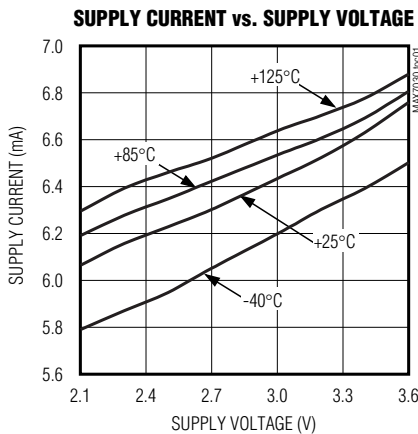

Low-Cost, 315MHz and 433.92MHz ASK Transceiver with Fractional-N PLL

Typical Operating Characteristics (continued)

(Typical Application Circuit, $V_{PAVDD} = V_{AVDD} = V_{DVDD} = V_{HVIN} = +3.0V$, $f_{RF} = 433.92MHz$, IF BW = 280kHz, 4kbps Manchester encoded, 0.2% BER, $T_A = +25^\circ C$, unless otherwise noted.)

RECEIVER

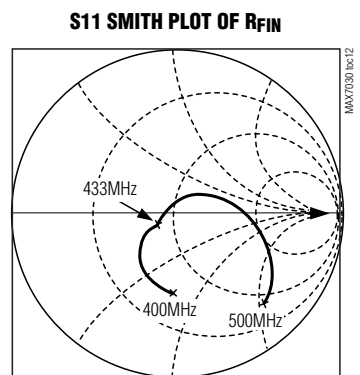
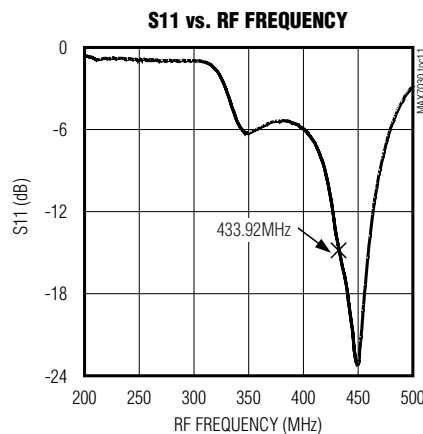
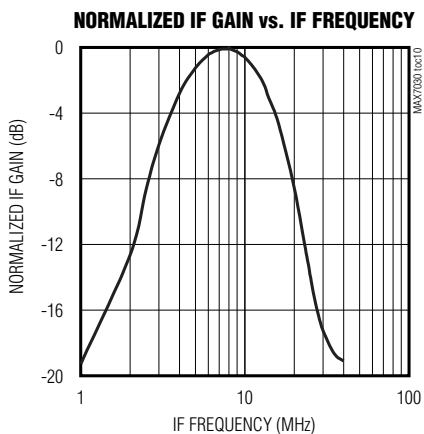
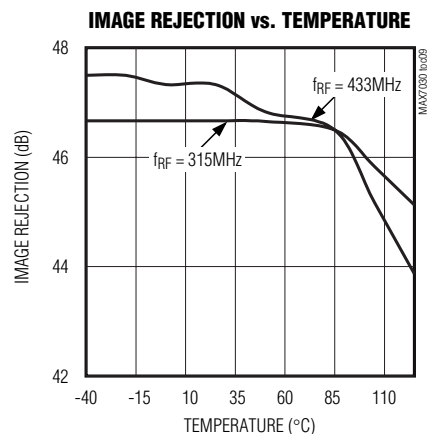
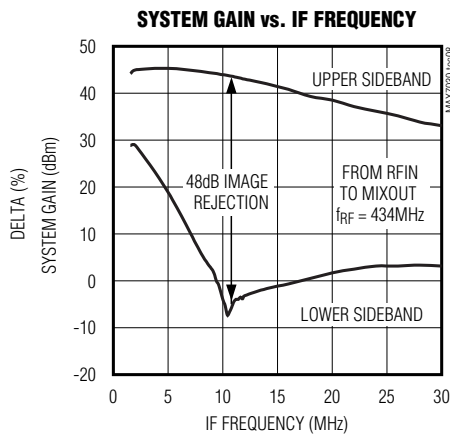
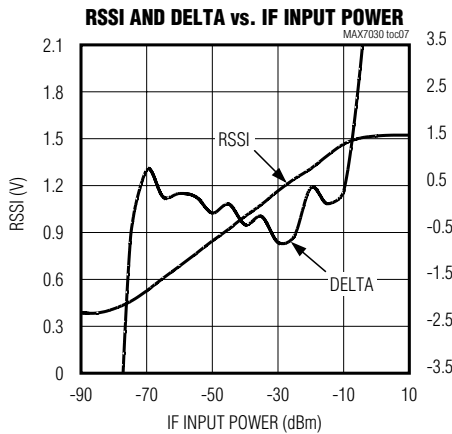
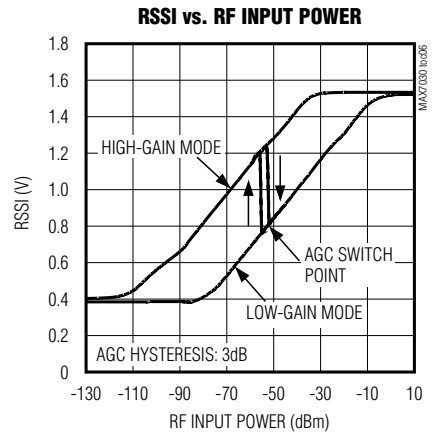
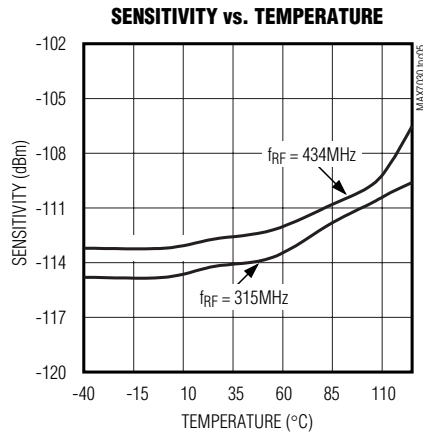
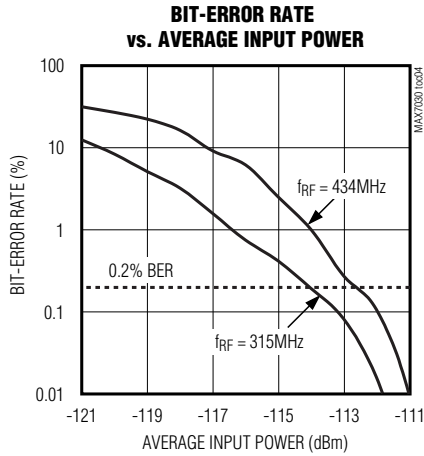

Low-Cost, 315MHz and 433.92MHz ASK Transceiver with Fractional-N PLL

MAX7030

Typical Operating Characteristics (continued)

(Typical Application Circuit, $V_{PAVDD} = V_{AVDD} = V_{DVDD} = V_{HVIN} = +3.0V$, $f_{RF} = 433.92MHz$, IF BW = 280kHz, 4kbps Manchester encoded, 0.2% BER, $T_A = +25^{\circ}C$, unless otherwise noted.)

RECEIVER

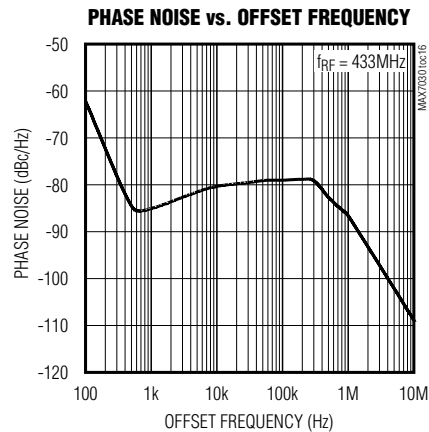
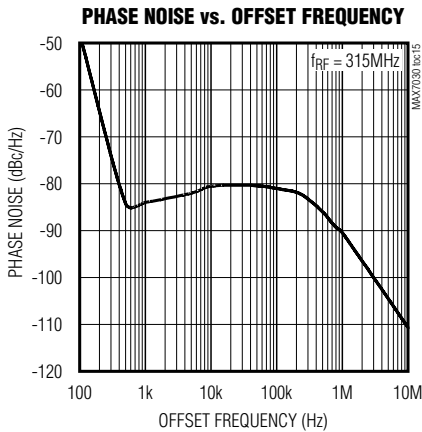
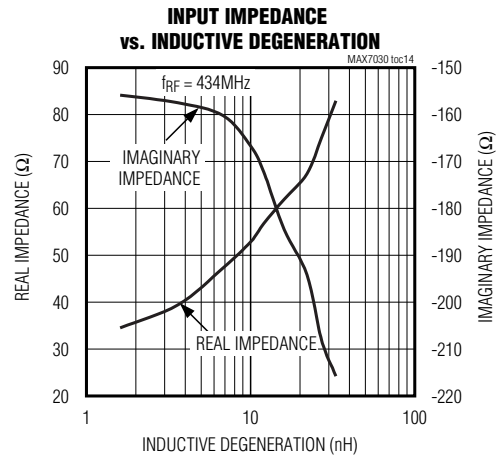
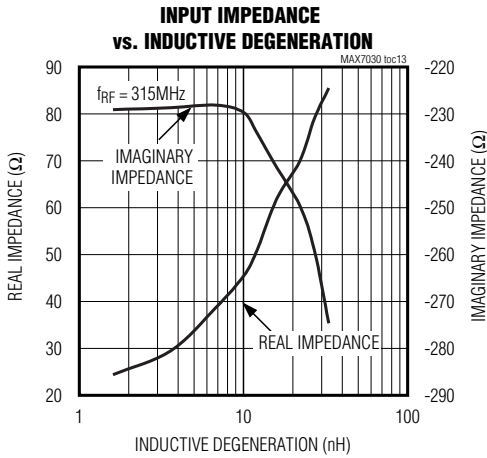

Low-Cost, 315MHz and 433.92MHz ASK Transceiver with Fractional-N PLL

Typical Operating Characteristics (continued)

(Typical Application Circuit, $V_{PAVDD} = V_{AVDD} = V_{DVDD} = V_{HVIN} = +3.0V$, $f_{RF} = 433.92MHz$, IF BW = 280kHz, 4kbps Manchester encoded, 0.2% BER, $T_A = +25^\circ C$, unless otherwise noted.)

TRANSMITTER

SUPPLY CURRENT vs. SUPPLY VOLTAGE

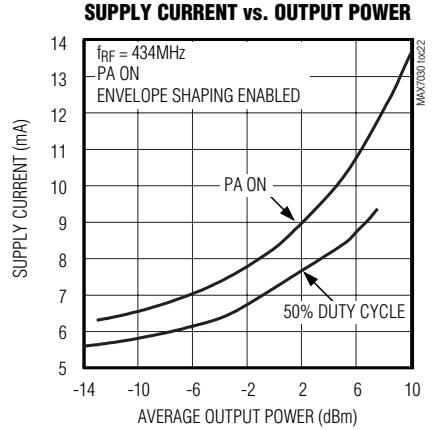
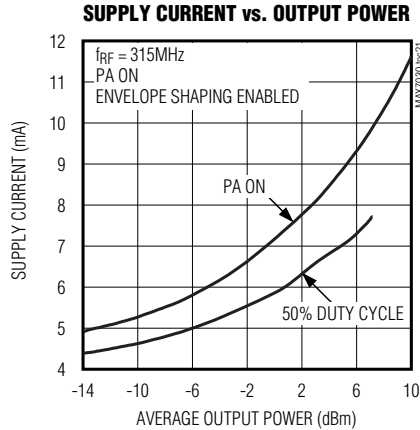
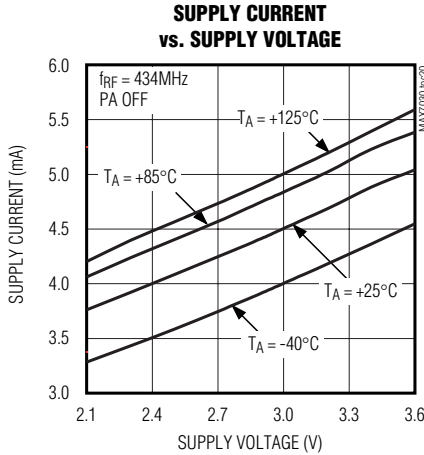
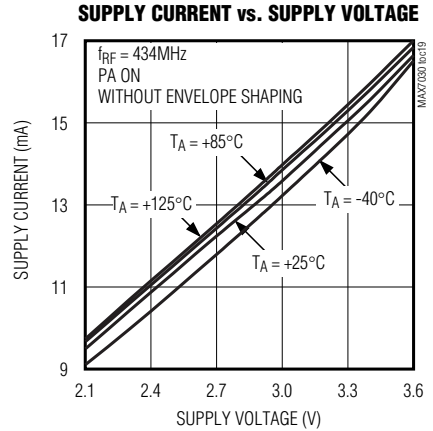
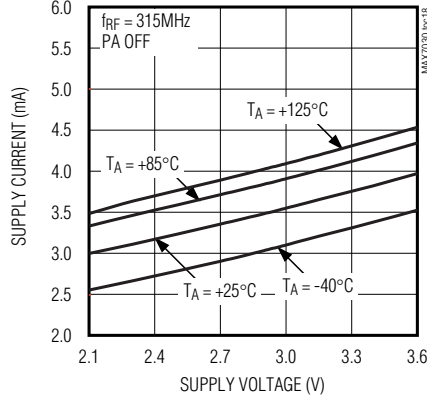
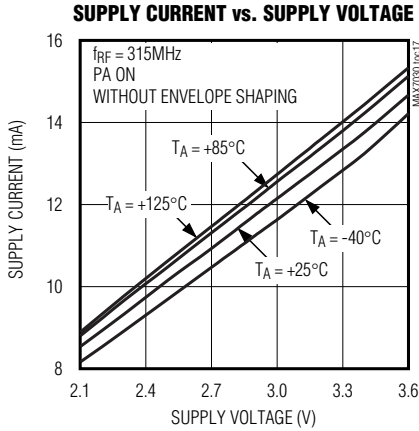

SUPPLY CURRENT AND OUTPUT POWER vs. EXTERNAL RESISTOR

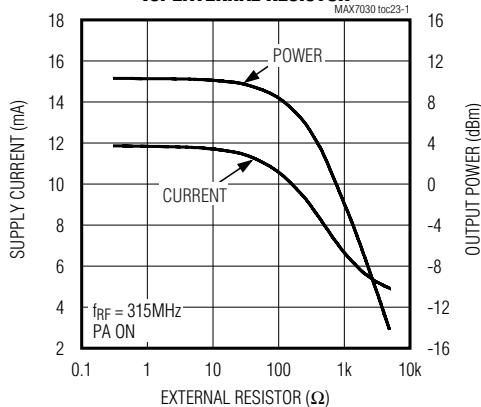

SUPPLY CURRENT AND OUTPUT POWER vs. EXTERNAL RESISTOR

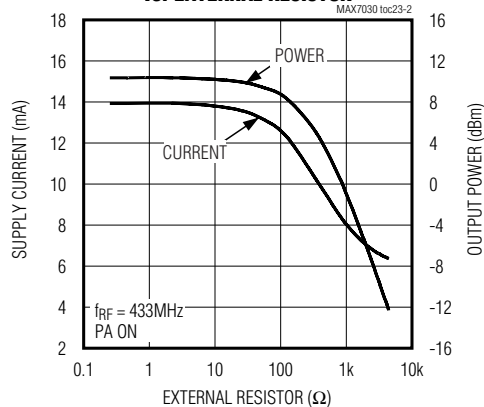

Low-Cost, 315MHz and 433.92MHz ASK Transceiver with Fractional-N PLL

MAX7030

Typical Operating Characteristics (continued)

(Typical Application Circuit, $V_{PAVDD} = V_{AVDD} = V_{DVDD} = V_{HVIN} = +3.0V$, $f_{RF} = 433.92MHz$, IF BW = 280kHz, 4kbps Manchester encoded, 0.2% BER, $T_A = +25^\circ C$, unless otherwise noted.)

TRANSMITTER

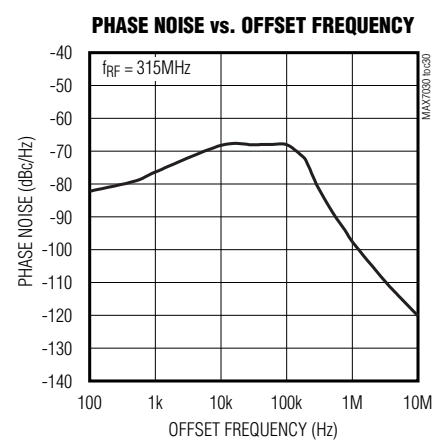
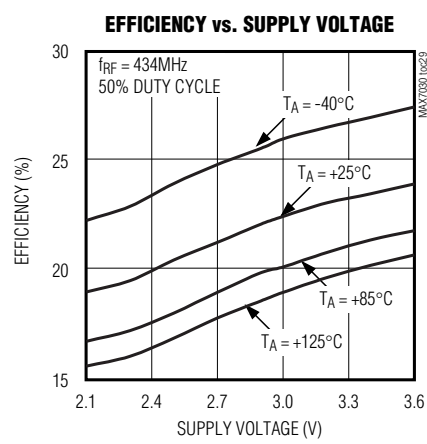
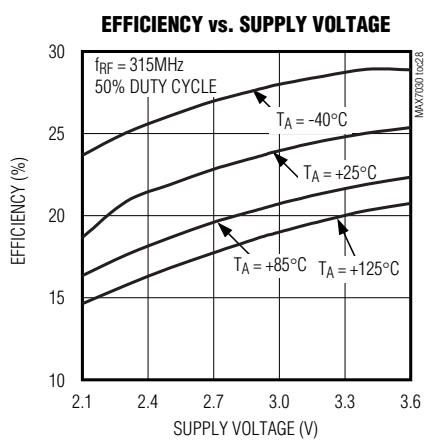
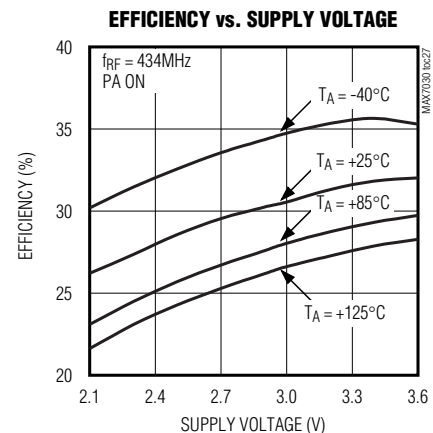
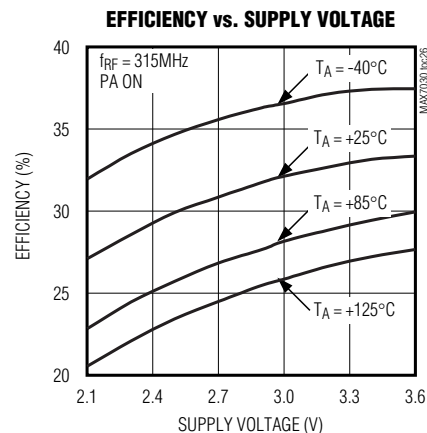
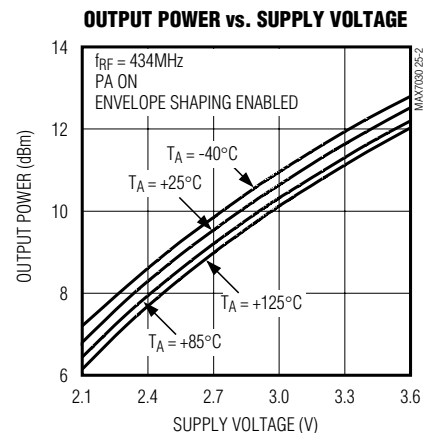
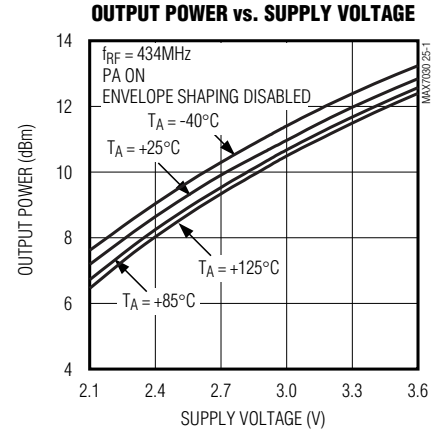
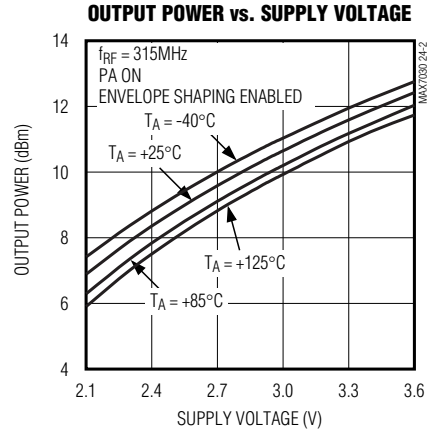
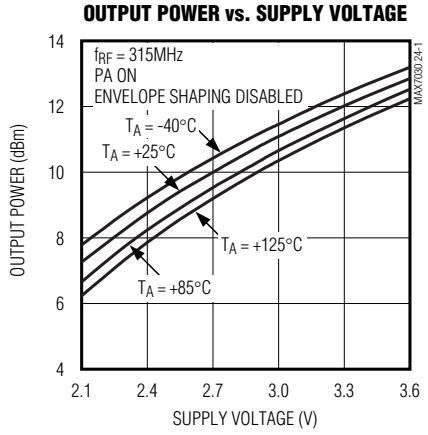

Low-Cost, 315MHz and 433.92MHz ASK Transceiver with Fractional-N PLL

Typical Operating Characteristics (continued)

(Typical Application Circuit, $V_{PAVDD} = V_{AVDD} = V_{DVDD} = V_{HVIN} = +3.0V$, $f_{RF} = 433.92MHz$, IF BW = 280kHz, 4kbps Manchester encoded, 0.2% BER, $T_A = +25^\circ C$, unless otherwise noted.)

TRANSMITTER

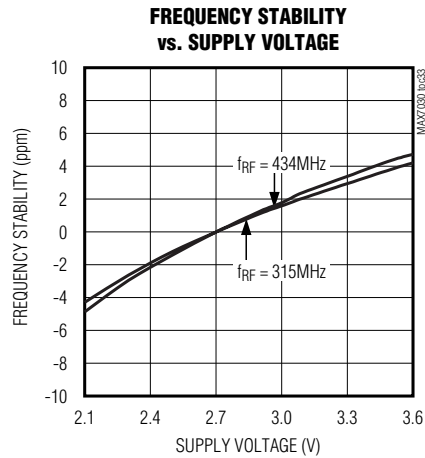
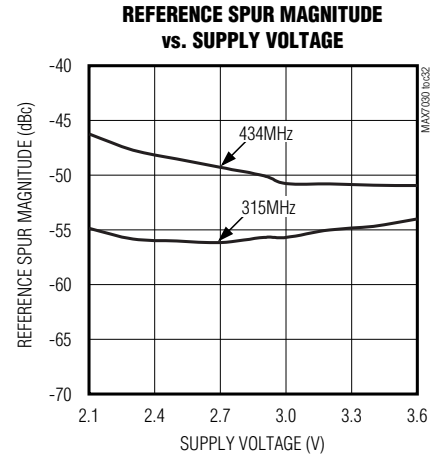
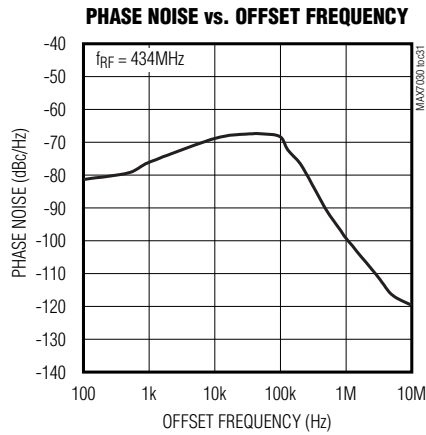

Low-Cost, 315MHz and 433.92MHz ASK Transceiver with Fractional-N PLL

Pin Description

MAX7030

PIN	NAME	FUNCTION
1	PAVDD	Power-Amplifier Supply Voltage. Bypass to GND with 0.01 μ F and 220pF capacitors placed as close as possible to the pin.
2	ROUT	Envelope-Shaping Output. ROUT controls the power-amplifier envelope's rise and fall times. Connect ROUT to the PA pullup inductor or optional power-adjust resistor. Bypass the inductor to GND as close as possible to the inductor with 680pF and 220pF capacitors, as shown in the <i>Typical Application Circuit</i> .
3	TX/RX1	Transmit/Receive Switch Throw. Drive T/ \bar{R} high to short TX/RX1 to TX/RX2. Drive T/ \bar{R} low to disconnect TX/RX1 from TX/RX2. Functionally identical to TX/RX2.
4	TX/RX2	Transmit/Receive Switch Pole. Typically connected to ground. See the <i>Typical Application Circuit</i> .
5	PAOUT	Power-Amplifier Output. Requires a pullup inductor to the supply voltage (or ROUT if envelope shaping is desired), which can be part of the output-matching network to an antenna.
6	AVDD	Analog Power-Supply Voltage. AVDD is connected to an on-chip +3.0V regulator in 5V operation. Bypass AVDD to GND with a 0.1 μ F and 220pF capacitor placed as close as possible to the pin.
7	LNAIN	Low-Noise Amplifier Input. Must be AC-coupled.
8	LNASRC	Low-Noise Amplifier Source for External Inductive Degeneration. Connect an inductor to GND to set the LNA input impedance.
9	LNAOUT	Low-Noise Amplifier Output. Must be connected to AVDD through a parallel LC tank filter. AC-couple to MIXIN+.
10	MIXIN+	Noninverting Mixer Input. Must be AC-coupled to the LNA output.
11	MIXIN-	Inverting Mixer Input. Bypass to AVDD with a capacitor as close as possible to the LNA LC tank filter.
12	MIXOUT	330 Ω Mixer Output. Connect to the input of the 10.7MHz filter.
13	IFIN-	Inverting 330 Ω IF Limiter-Amplifier Input. Bypass to GND with a capacitor.
14	IFIN+	Noninverting 330 Ω IF Limiter-Amplifier Input. Connect to the output of the 10.7MHz IF filter.
15	PDMIN	Minimum-Level Peak Detector for Demodulator Output
16	PDMAX	Maximum-Level Peak Detector for Demodulator Output
17	DS-	Inverting Data Slicer Input
18	DS+	Noninverting Data Slicer Input
19	OP+	Noninverting Op-Amp Input for the Sallen-Key Data Filter
20	DF	Data-Filter Feedback Node. Input for the feedback capacitor of the Sallen-Key data filter.
21, 25	N.C.	No Connection. Do not connect to this pin.
22	T/ \bar{R}	Transmit/Receive. Drive high to put the device in transmit mode. Drive low or leave unconnected to put the device in receive mode. It is internally pulled down.
23	ENABLE	Enable. Drive high for normal operation. Drive low or leave unconnected to put the device into shut-down mode.
24	DATA	Receiver Data Output/Transmitter Data Input
26	DVDD	Digital Power-Supply Voltage. Bypass to GND with a 0.01 μ F and 220pF capacitor placed as close as possible to the pin.
27	HVIN	High-Voltage Supply Input. For 3V operation, connect HVIN to AVDD, DVDD, and PAVDD. For 5V operation, connect only HVIN to 5V. Bypass HVIN to GND with a 0.01 μ F and 220pF capacitor placed as close as possible to the pin.

Low-Cost, 315MHz and 433.92MHz ASK Transceiver with Fractional-N PLL

Pin Description (continued)

PIN	NAME	FUNCTION
28	AGC2	AGC Enable/Dwell Time Control 2 (MSB). See Table 1. Bypass to GND with a 10pF capacitor.
29	AGC1	AGC Enable/Dwell Time Control 1. See Table 1. Bypass to GND with a 10pF capacitor.
30	AGC0	AGC Enable/Dwell Time Control 0 (LSB). See Table 1. Bypass to GND with a 10pF capacitor.
31	XTAL1	Crystal Input 1. Bypass to GND if XTAL2 is driven by an AC-coupled external reference.
32	XTAL2	Crystal Input 2. XTAL2 can be driven from an external AC-coupled reference.
—	EP	Exposed Pad. Solder evenly to the board's ground plane for proper operation.

Detailed Description

The MAX7030 315MHz and 433.92MHz CMOS transceiver and a few external components provide a complete transmit and receive chain from the antenna to the digital data interface. This device is designed for transmitting and receiving ASK data. All transmit frequencies are generated by a fractional-N-based synthesizer, allowing for very fine frequency steps in increments of $f_{XTAL}/4096$. The receive LO is generated by a traditional integer-N-based synthesizer. Depending on component selection, data rates as high as 33kbps (Manchester encoded) or 66kbps (NRZ encoded) can be achieved.

Receiver

Low-Noise Amplifier (LNA)

The LNA is a cascode amplifier with off-chip inductive degeneration that achieves approximately 30dB of voltage gain that is dependent on both the antenna-matching network at the LNA input and the LC tank network between the LNA output and the mixer inputs.

The off-chip inductive degeneration is achieved by connecting an inductor from LNASRC to GND. This inductor sets the real part of the input impedance at LNAIN, allowing for a more flexible match for low-input impedances such as a PCB trace antenna. A nominal value for this inductor with a 50Ω input impedance is 12nH at 315MHz and 10nH at 434MHz, but the inductance is affected by PCB trace length. LNASRC can be shorted to ground to increase sensitivity by approximately 1dB, but the input match must then be reoptimized.

The LC tank filter connected to LNAOUT consists of L5 and C9 (see the *Typical Application Circuit*). Select L5 and C9 to resonate at the desired RF input frequency. The resonant frequency is given by:

$$f = \frac{1}{2\pi\sqrt{L_{TOTAL} \times C_{TOTAL}}}$$

where $L_{TOTAL} = L5 + L_{PARASITICS}$ and $C_{TOTAL} = C9 + C_{PARASITICS}$.

$L_{PARASITICS}$ and $C_{PARASITICS}$ include inductance and capacitance of the PCB traces, package pins, mixer-input impedance, LNA-output impedance, etc. These parasitics at high frequencies cannot be ignored, and can have a dramatic effect on the tank filter center frequency. Lab experimentation should be done to optimize the center frequency of the tank. The total parasitic capacitance is generally between 5pF and 7pF.

Automatic Gain Control (AGC)

When the AGC is enabled, it monitors the RSSI output. When the RSSI output reaches 1.28V, which corresponds to an RF input level of approximately -55dBm, the AGC switches on the LNA gain-reduction attenuator. The attenuator reduces the LNA gain by 36dB, thereby reducing the RSSI output by about 540mV to 740mV. The LNA resumes high-gain mode when the RSSI output level drops back below 680mV (approximately -59dBm at the RF input) for a programmable interval called the AGC dwell time (see Table 1). The AGC has a hysteresis of approximately 4dB. With the AGC function, the RSSI dynamic range is increased, allowing the MAX7030 to reliably produce an ASK output for RF input levels up to 0dBm with a modulation depth of 18dB. AGC is not required and can be disabled (see Table 1).

Low-Cost, 315MHz and 433.92MHz ASK Transceiver with Fractional-N PLL

Table 1. AGC Dwell Time Settings for MAX7030

AGC2	AGC1	AGC0	DESCRIPTION
0	0	0	AGC disabled, high gain selected
0	0	1	K = 11
0	1	0	K = 13
0	1	1	K = 15
1	0	0	K = 17
1	0	1	K = 19
1	1	0	K = 21
1	1	1	K = 23

AGC Dwell-Time Settings

The AGC dwell timer holds the AGC in low-gain state for a set amount of time after the power level drops below the AGC switching threshold. After that set amount of time, if the power level is still below the AGC threshold, the LNA goes into high-gain state. This is important for ASK since the modulated data may have a high level above the threshold and low level below the threshold, which without the dwell timer would cause the AGC to switch on every bit.

The MAX7030 uses the three AGC control pins (AGC0, AGC1, AGC2) to set seven user-controlled, dwell-timer settings. The AGC dwell time is dependent on the crystal frequency and the bit settings of the AGC control pins. To calculate the dwell time, use the following equation:

$$\text{Dwell Time} = \frac{2^K}{f_{\text{XTAL}}}$$

where K is an odd integer in decimal from 11 to 23, determined by the control pin settings shown in Table 1.

To calculate the value of K, use the following equation and use the next integer higher than the calculated result:

$$K \geq 3.3 \times \log_{10} (\text{Dwell Time} \times f_{\text{XTAL}})$$

For Manchester Code (50% duty cycle), set the dwell time to at least twice the bit period. For nonreturn-to-zero (NRZ) data, set the dwell to greater than the period of the longest string of zeros or ones. For example, using Manchester Code at 315MHz ($f_{\text{XTAL}} = 12.679\text{MHz}$) with a data rate of 2kbps (bit period = 250 μs), the dwell time needs to be greater than 500 μs :

$$K \geq 3.3 \times \log_{10} (500\mu\text{s} \times 12.679) \approx 12.546$$

Choose the AGC pin settings for K to be the next odd-integer value higher than 12.546, which is 13. This says that AGC1 is set high and AGC0 and AGC2 are set low.

Mixer

A unique feature of the MAX7030 is the integrated image rejection of the mixer. This eliminates the need for a costly front-end SAW filter for many applications. The advantage of not using a SAW filter is increased sensitivity, simplified antenna matching, less board space, and lower cost.

The mixer cell is a pair of double-balanced mixers that perform an IQ downconversion of the RF input to the 10.7MHz intermediate frequency (IF) with low-side injection (i.e., $f_{\text{LO}} = f_{\text{RF}} - f_{\text{IF}}$). The image-rejection circuit then combines these signals to achieve a typical 46dB of image rejection over the full temperature range. Low-side injection is required as high-side injection is not possible due to the on-chip image rejection. The IF output is driven by a source follower, biased to create a driving impedance of 330 Ω to interface with an off-chip 330 Ω ceramic IF filter. The voltage-conversion gain driving a 330 Ω load is approximately 20dB. Note that the MIXIN+ and MIXIN- inputs are functionally identical.

Integer-N Phase-Locked Loop (PLL)

The MAX7030 utilizes a fixed-integer-N PLL to generate the receive LO. All PLL components, including the loop filter, voltage-controlled oscillator, charge pump, asynchronous 24x divider, and phase-frequency detector are integrated internally. The loop bandwidth is approximately 500kHz. The relationship between RF, IF, and crystal reference frequencies is given by:

$$f_{\text{XTAL}} = (f_{\text{RF}} - f_{\text{IF}})/24$$

Low-Cost, 315MHz and 433.92MHz ASK Transceiver with Fractional-N PLL

Intermediate Frequency (IF)

The IF section presents a differential 330Ω load to provide matching for the off-chip ceramic filter. The internal six AC-coupled limiting amplifiers produce an overall gain of approximately 65dB, with a bandpass filter type response centered near the 10.7MHz IF frequency with a 3dB bandwidth of approximately 10MHz. For ASK data, the RSSI circuit demodulates the IF to baseband by producing a DC output proportional to the log of the IF signal level with a slope of approximately 15mV/dB.

Data Filter

The data filter for the demodulated data is implemented as a 2nd-order, lowpass, Sallen-Key filter. The pole locations are set by the combination of two on-chip resistors and two external capacitors. Adjusting the value of the external capacitors changes the corner frequency to optimize for different data rates. Set the corner frequency in kHz to approximately 3 times the fastest expected Manchester data rate in kbps from the transmitter (1.5 times the fastest expected NRZ data rate). Keeping the corner frequency near the data rate rejects any noise at higher frequencies, resulting in an increase in receiver sensitivity.

The configuration shown in Figure 1 can create a Butterworth or Bessel response. The Butterworth filter offers a very-flat-amplitude response in the passband and a rolloff rate of 40dB/decade for the two-pole filter. The Bessel filter has a linear phase response, which works well for filtering digital data. To calculate the value of the capacitors, use the following equations, along with the coefficients in Table 2:

$$C_{F1} = \frac{b}{a(100k\Omega)(\pi)(f_c)}$$

$$C_{F2} = \frac{a}{4(100k\Omega)(\pi)(f_c)}$$

where f_c is the desired 3dB corner frequency.

For example, choose a Butterworth filter response with a corner frequency of 5kHz:

$$C_{F1} = \frac{1.000}{(1.414)(100k\Omega)(3.14)(5kHz)} \approx 450pF$$

$$C_{F2} = \frac{1.414}{(4)(100k\Omega)(3.14)(5kHz)} \approx 225pF$$

Choosing standard capacitor values changes C_{F1} to 470pF and C_{F2} to 220pF. In the *Typical Application Circuit*, C_{F1} and C_{F2} are named C16 and C17, respectively.

Data Slicer

The data slicer takes the analog output of the data filter and converts it to a digital signal. This is achieved by using a comparator and comparing the analog input to a threshold voltage. The threshold voltage is set by the voltage on the DS- pin, which is connected to the negative input of the data slicer comparator.

Numerous configurations can be used to generate the data-slicer threshold. For example, the circuit in Figure 2 shows a simple method using only one resistor and one capacitor. This configuration averages the analog output of the filter and sets the threshold to approximately 50% of that amplitude. With this configuration, the threshold automatically adjusts as the analog signal varies, minimizing the possibility for errors in the digital data. The values of R and C affect how fast the threshold tracks the analog amplitude. Be sure to keep the corner frequency of the RC circuit much lower (about 10 times) than the lowest expected data rate.

With this configuration, a long string of NRZ zeros or ones can cause the threshold to drift. This configuration works best if a coding scheme, such as Manchester coding, which has an equal number of zeros and ones, is used.

Figure 3 shows a configuration that uses the positive and negative peak detectors to generate the threshold. This configuration sets the threshold to the midpoint between a high output and a low output of the data filter.

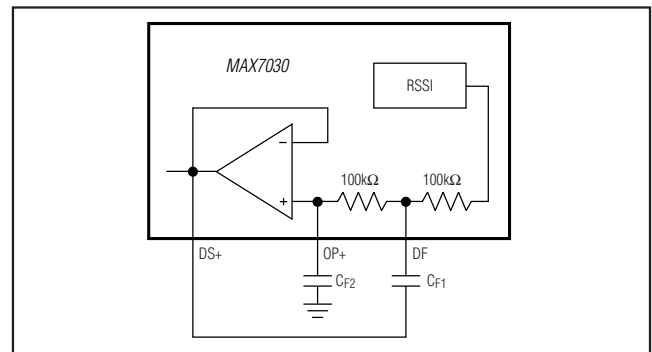

Figure 1. Sallen-Key Lowpass Data Filter

Table 2. Coefficients to Calculate C_{F1} and C_{F2}

FILTER TYPE	a	b
Butterworth (Q = 0.707)	1.414	1.000
Bessel (Q = 0.577)	1.3617	0.618

Low-Cost, 315MHz and 433.92MHz ASK Transceiver with Fractional-N PLL

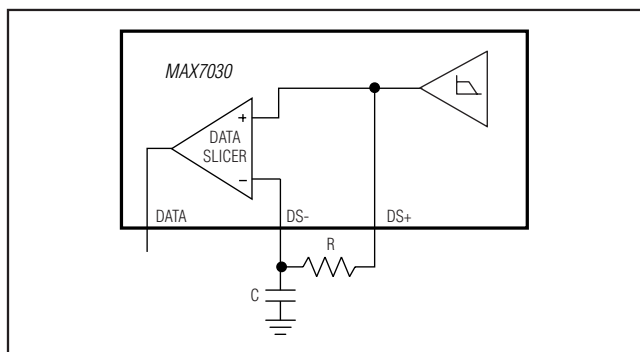

Figure 2. Generating Data-Slicer Threshold Using a Lowpass Filter

Peak Detectors

The maximum peak detector (PDMAX) and minimum peak detector (PDMIN), with resistors and capacitors shown in Figure 3, create DC output voltages equal to the high- and low-peak values of the filtered demodulated signal. The resistors provide a path for the capacitors to discharge, allowing the peak detectors to dynamically follow peak changes of the data filter output voltages.

The maximum and minimum peak detectors can be used together to form a data slicer threshold voltage at a value midway between the maximum and minimum voltage levels of the data stream (see the *Data Slicer* section and Figure 3). Set the RC time constant of the peak detector combining network to at least 5 times the data period.

If there is an event that causes a significant change in the magnitude of the baseband signal, such as an AGC gain-switch or a power-up transient, the peak detectors may “catch” a false level. If a false peak is detected, the slicing level is incorrect. The MAX7030 peak detectors correct these problems by temporarily tracking the incoming baseband filter voltage when an AGC state switch occurs, or forcing the peak detectors to track the baseband filter output voltage until all internal circuits are stable following an enable pin low-to-high transition and also T/R pin high-to-low transition. The peak detectors exhibit a fast attack/slow decay response. This feature allows for an extremely fast startup or AGC recovery.

Transmitter

Power Amplifier (PA)

The PA of the MAX7030 is a high-efficiency, open-drain, switch-mode amplifier. The PA with proper output-matching network can drive a wide range of antenna impedances, which includes a small-loop PCB trace and a 50Ω antenna. The output-matching network

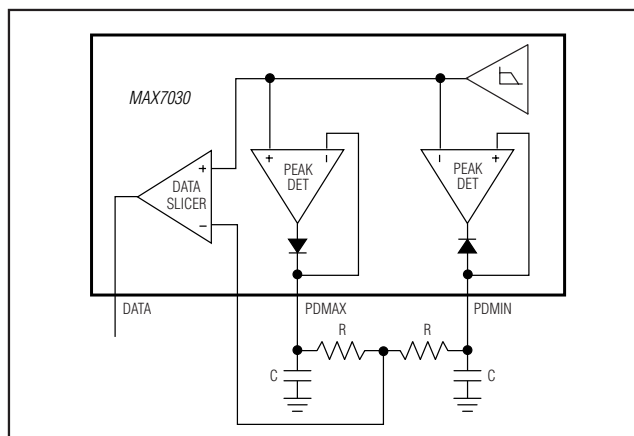

Figure 3. Generating Data-Slicer Threshold Using the Peak Detectors

for a 50Ω antenna is shown in the *Typical Application Circuit*. The output-matching network suppresses the carrier harmonics and transforms the antenna impedance to an optimal impedance at PAOUT (pin 5). The optimal impedance at PAOUT is between 100Ω and 150Ω to transmit +10dBm with a 2.7V supply.

When the output-matching network is properly tuned, the PA transmits power with a high overall efficiency of up to 32%. The efficiency of the PA itself is more than 46%. The output power is set by an external resistor at PAOUT and is also dependent on the external antenna and antenna-matching network at the PA output.

Envelope Shaping

The MAX7030 features an internal envelope-shaping resistor, which connects between the open-drain output of the PA and the power supply (see the *Typical Application Circuit*). The envelope-shaping resistor slows the turn-on/turn-off of the PA in ASK mode and results in a smaller spectral width of the modulated PA output signal.

Fractional-N Phase-Locked Loop (PLL)

The MAX7030 utilizes a fully integrated, fractional-N, PLL for its transmit frequency synthesizer. All PLL components, including the loop filter, are integrated internally. The loop bandwidth is approximately 200kHz.

Power-Supply Connections

The MAX7030 can be powered from a 2.1V to 3.6V supply or a 4.5V to 5.5V supply. If a 4.5V to 5.5V supply is used, then the on-chip linear regulator reduces the 5V supply to the 3V needed to operate the chip.

To operate the MAX7030 from a 3V supply, connect PAVDD, AVDD, DVDD, and HVIN to the 3V supply. When using a 5V supply, connect the supply to HVIN

Low-Cost, 315MHz and 433.92MHz ASK Transceiver with Fractional-N PLL

only and connect AVDD, PAVDD, and DVDD together. In both cases, bypass DVDD, HVIN, and PAVDD to GND with 0.01 μ F and 220pF capacitors and bypass AVDD to GND with 0.1 μ F and 220pF capacitors. Bypass T/R, ENABLE, DATA, and AGC0-2 with 10pF capacitors to GND. Place all bypass capacitors as close as possible to the respective pins.

Transmit/Receive Antenna Switch

The MAX7030 features an internal SPST RF switch that, when combined with a few external components, allows the transmit and receive pins to share a common antenna (see the *Typical Application Circuit*). In receive mode, the switch is open and the power amplifier is shut down, presenting a high impedance to minimize the loading of the LNA. In transmit mode, the switch closes to complete a resonant tank circuit at the PA output and forms an RF short at the input to the LNA. In this mode, the external passive components couple the output of the PA to the antenna and protect the LNA input from strong transmitted signals.

The switch state is controlled by the T/R pin (pin 22). Drive T/R high to put the device in transmit mode; drive T/R low to put the device in receive mode.

Control Interface Considerations

When operating the MAX7030 with a +4.5V to +5.5V supply voltage, the AGC0, ACG1, ACG2, DATA, ENABLE and T/R pins may be driven by a microcontroller with either 3V or 5V interface logic levels. When operating the MAX7030 with a +2.1V to +3.6V supply, the microcontroller must produce logic levels which conform to the V_{IH} and V_{IL} specifications in the *DC Electrical Characteristics* for the MAX7030.

Crystal Oscillator (XTAL)

The XTAL oscillator in the MAX7030 is designed to present a capacitance of approximately 3pF between the XTAL1 and XTAL2 pins. In most cases, this corresponds to a 4.5pF load capacitance applied to the external crystal when typical PCB parasitics are added. **It is very important to use a crystal with a load capacitance that is equal to the capacitance of the MAX7030 crystal oscillator plus PCB parasitics.** If a crystal designed to oscillate with a different load capacitance is used, the crystal is pulled away from its stated operating frequency, introducing an error in the reference frequency. Crystals designed to operate with higher differential load capacitance always pull the reference frequency higher.

In actuality, the oscillator pulls every crystal. The crystal's natural frequency is really below its specified frequency, but when loaded with the specified load capacitance, the crystal is pulled and oscillates at its specified frequency. This pulling is already accounted for in the specification of the load capacitance.

Additional pulling can be calculated if the electrical parameters of the crystal are known. The frequency pulling is given by:

$$f_p = \frac{C_m}{2} \left(\frac{1}{C_{CASE} + C_{LOAD}} - \frac{1}{C_{CASE} + C_{SPEC}} \right) \times 10^6$$

where:

f_p is the amount the crystal frequency is pulled in ppm.

C_m is the motional capacitance of the crystal.

C_{CASE} is the case capacitance.

C_{SPEC} is the specified load capacitance.

C_{LOAD} is the actual load capacitance.

When the crystal is loaded as specified, i.e., $C_{LOAD} = C_{SPEC}$, the frequency pulling equals zero.

Pin Configuration

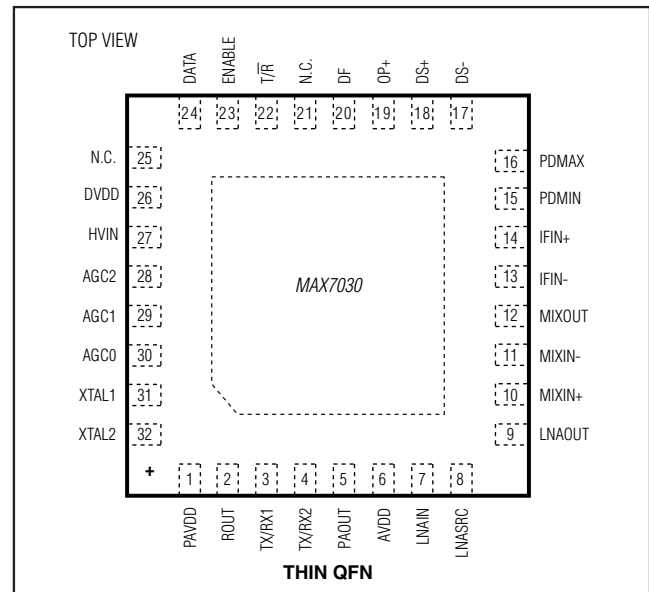

Low-Cost, 315MHz and 433.92MHz ASK Transceiver with Fractional-N PLL

MAX7030

Table 3. Component Values for Typical Application Circuit

COMPONENT	VALUE FOR 433.92MHz RF	VALUE FOR 315MHz RF	DESCRIPTION
C1	220pF	220pF	5%
C2	680pF	680pF	5%
C3	6.8pF	12pF	5%
C4	6.8pF	10pF	5%
C5	10pF	22pF	5%
C6	220pF	220pF	5%
C7	0.1μF	0.1μF	10%
C8	100pF	100pF	5%
C9	1.8pF	2.7pF	±0.1pF
C10	100pF	100pF	5%
C11	220pF	220pF	5%
C12	100pF	100pF	5%
C13	1500pF	1500pF	10%
C14	0.047μF	0.047μF	10%
C15	0.047μF	0.047μF	10%
C16	470pF	470pF	5%
C17	220pF	220pF	5%
C18	220pF	220pF	5%
C19	0.01μF	0.01μF	5%
C20	100pF	100pF	5%
C21	100pF	100pF	5%
C22	220pF	220pF	5%
C23	0.01μF	0.01μF	10%
C24	0.01μF	0.01μF	10%
L1	22nH	27nH	5% or better*
L2	22nH	30nH	5% or better*
L3	22nH	30nH	5% or better*
L4	10nH	12nH	5% or better*
L5	16nH	30nH	5% or better*
L6	68nH	100nH	5% or better*
R1	100kΩ	100kΩ	5%
R2	100kΩ	100kΩ	5%
R3	0Ω	0Ω	—
X1	17.63416MHz	12.67917MHz	Crystal, 4.5pF C _{LOAD} , Crystek or Hong Kong Crystal
Y1	10.7MHz ceramic filter	10.7MHz ceramic filter	Murata

*Wire Wound recommended.

Note: Component values vary depending on PCB layout.

Low-Cost, 315MHz and 433.92MHz ASK Transceiver with Fractional-N PLL

Typical Application Circuit

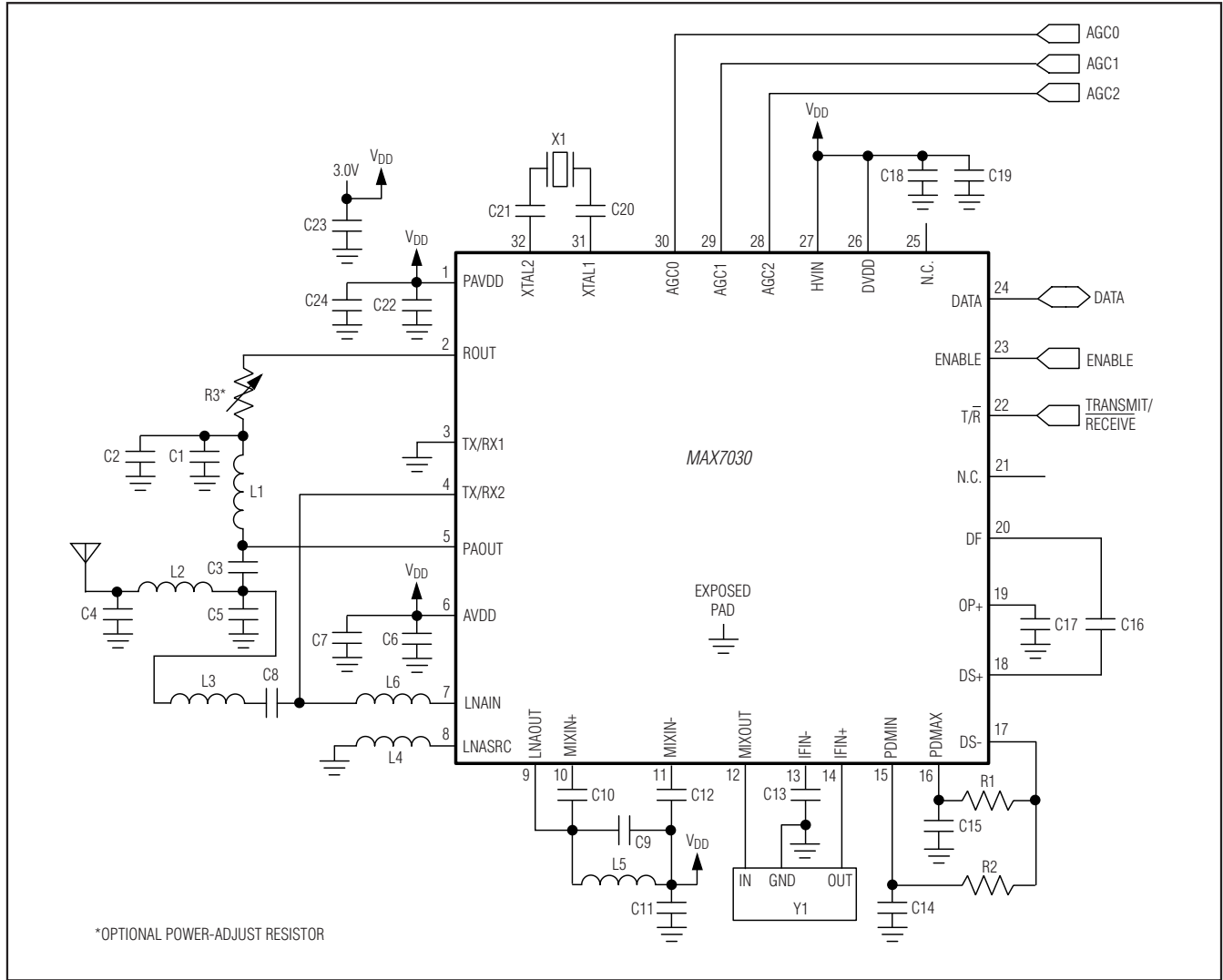

Chip Information

PROCESS: CMOS

Package Information

For the latest package outline information and land patterns (footprints), go to www.maxim-ic.com/packages. Note that a "+", "#", or "-" in the package code indicates RoHS status only. Package drawings may show a different suffix character, but the drawing pertains to the package regardless of RoHS status.

PACKAGE TYPE	PACKAGE CODE	OUTLINE NO.	LAND PATTERN NO.
32 Thin QFN-EP	T3255+3	21-0140	90-0001

Low-Cost, 315MHz and 433.92MHz ASK Transceiver with Fractional-N PLL

Functional Diagram

MAX7030

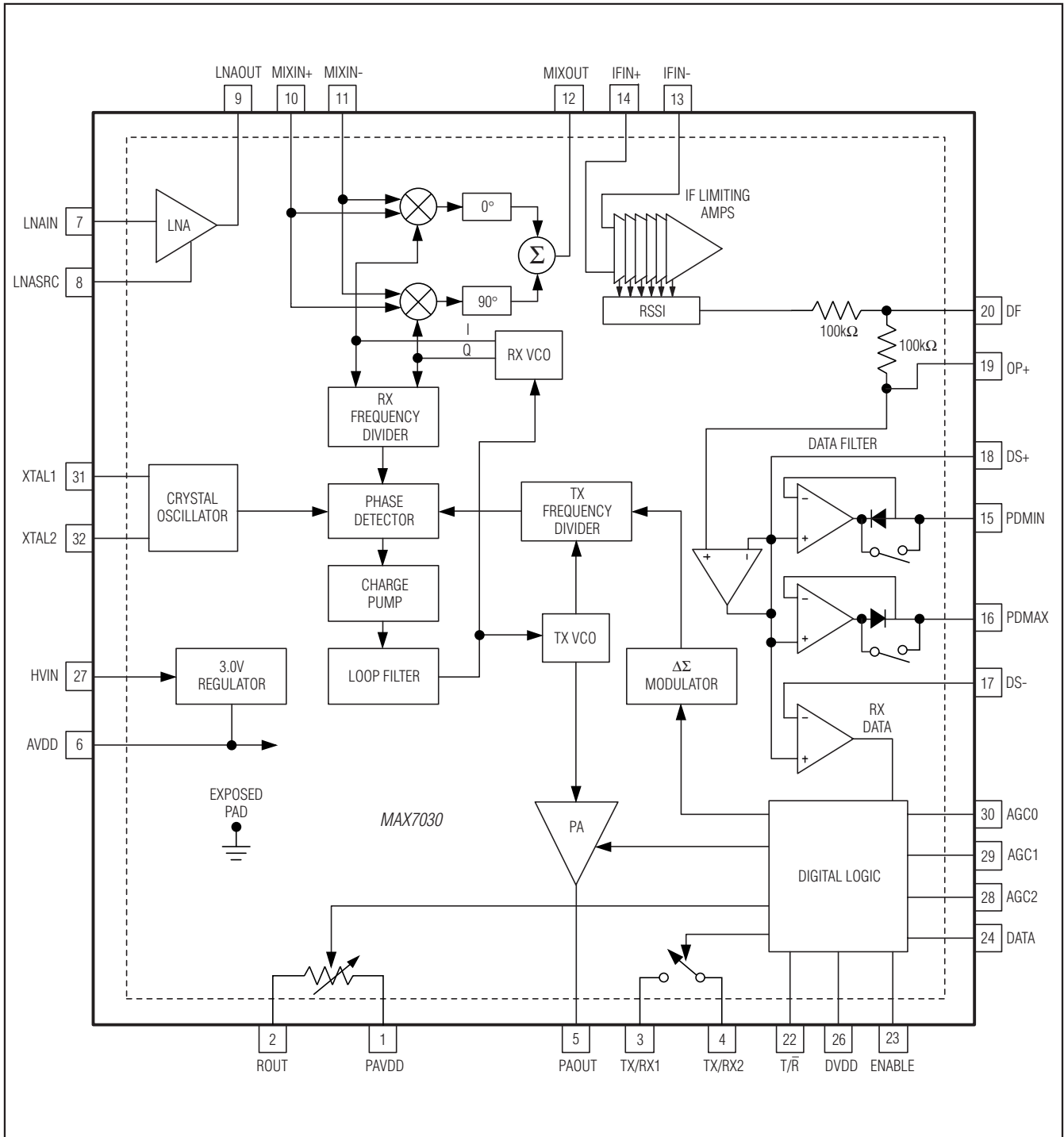

Low-Cost, 315MHz and 433.92MHz ASK Transceiver with Fractional-N PLL

Revision History

REVISION NUMBER	REVISION DATE	DESCRIPTION	PAGES CHANGED
0	5/05	Initial release	—
1	9/08	Added + to each part to denote lead-free/RoHS-compliant package and explicitly calling out the odd frequency as contact factory for availability	1
2	6/09	Made correction in <i>Power Amplifier (PA)</i> section	15
3	11/10	Updated <i>AC Electrical Characteristics, Absolute Maximum Ratings, and Package Information</i>	2, 5, 18
4	6/12	Deleted the MAX7030MATJ+ from the <i>Selector Guide</i> and all references to the MAX7030MATJ+ throughout the data sheet; updated f _{XTAL} reference in the <i>Phase-Locked Loop</i> section; updated <i>Power Amplifier</i> section; inserted <i>Control Interface Considerations</i> ; updated Table 3	1, 13, 15, 16, 17, 18

Maxim cannot assume responsibility for use of any circuitry other than circuitry entirely embodied in a Maxim product. No circuit patent licenses are implied. Maxim reserves the right to change the circuitry and specifications without notice at any time. The parametric values (min and max limits) shown in the Electrical Characteristics table are guaranteed. Other parametric values quoted in this data sheet are provided for guidance.

20 **Maxim Integrated Products, 160 Rio Robles, San Jose, CA 95134 USA 1-408-601-1000**

Компания «Океан Электроники» предлагает заключение долгосрочных отношений при поставках импортных электронных компонентов на взаимовыгодных условиях!

Наши преимущества:

- Поставка оригинальных импортных электронных компонентов напрямую с производств Америки, Европы и Азии, а так же с крупнейших складов мира;
- Широкая линейка поставок активных и пассивных импортных электронных компонентов (более 30 млн. наименований);
- Поставка сложных, дефицитных, либо снятых с производства позиций;
- Оперативные сроки поставки под заказ (от 5 рабочих дней);
- Экспресс доставка в любую точку России;
- Помощь Конструкторского Отдела и консультации квалифицированных инженеров;
- Техническая поддержка проекта, помощь в подборе аналогов, поставка прототипов;
- Поставка электронных компонентов под контролем ВП;
- Система менеджмента качества сертифицирована по Международному стандарту ISO 9001;
- При необходимости вся продукция военного и аэрокосмического назначения проходит испытания и сертификацию в лаборатории (по согласованию с заказчиком);
- Поставка специализированных компонентов военного и аэрокосмического уровня качества (Xilinx, Altera, Analog Devices, Intersil, Interpoint, Microsemi, Actel, Aeroflex, Peregrine, VPT, Syfer, Eurofarad, Texas Instruments, MS Kennedy, Miteq, Cobham, E2V, MA-COM, Hittite, Mini-Circuits, General Dynamics и др.);

Компания «Океан Электроники» является официальным дистрибьютором и эксклюзивным представителем в России одного из крупнейших производителей разъемов военного и аэрокосмического назначения «JONHON», а так же официальным дистрибьютором и эксклюзивным представителем в России производителя высокотехнологичных и надежных решений для передачи СВЧ сигналов «FORSTAR».



JONHON

«JONHON» (основан в 1970 г.)

Разъемы специального, военного и аэрокосмического назначения:

(Применяются в военной, авиационной, аэрокосмической, морской, железнодорожной, горно- и нефтедобывающей отраслях промышленности)

«FORSTAR» (основан в 1998 г.)

ВЧ соединители, коаксиальные кабели,
кабельные сборки и микроволновые компоненты:

(Применяются в телекоммуникациях гражданского и специального назначения, в средствах связи, РЛС, а так же военной, авиационной и аэрокосмической отраслях промышленности).



Телефон: 8 (812) 309-75-97 (многоканальный)

Факс: 8 (812) 320-03-32

Электронная почта: ocean@oceanchips.ru

Web: <http://oceanchips.ru/>

Адрес: 198099, г. Санкт-Петербург, ул. Калинина, д. 2, корп. 4, лит. А