

# NUP3105L, SZNUP3105L

## ESD Protection Diode

### Dual Line CAN Bus Protector

The SZ/NUP3105L has been designed to protect the CAN transceiver in 24 V systems from ESD and other harmful transient voltage events. This device provides bidirectional protection for each data line with a single compact SOT-23 package, giving the system designer a low cost option for improving system reliability and meeting stringent EMI requirements.

#### Features

- 350 W Peak Power Dissipation per Line (8/20  $\mu$ sec Waveform)
- Low Reverse Leakage Current (< 100 nA)
- Low Capacitance High-Speed CAN Data Rates
- IEC Compatibility:
  - IEC 61000-4-2 (ESD): Level 4
  - IEC 61000-4-4 (EFT): 50 A – 5/50 ns
  - IEC 61000-4-5 (Lighting) 8.0 A (8/20  $\mu$ s)
- Flammability Rating UL 94 V-0
- SZ Prefix for Automotive and Other Applications Requiring Unique Site and Control Change Requirements; AEC-Q101 Qualified and PPAP Capable
- These Devices are Pb-Free, Halogen Free/BFR Free and are RoHS Compliant

#### Applications

- Industrial Control Networks
  - ◆ Smart Distribution Systems (SDS<sup>®</sup>)
  - ◆ DeviceNet<sup>™</sup>
- Automotive Networks
  - ◆ Low and High-Speed CAN
  - ◆ Fault Tolerant CAN
  - ◆ Trucks



ON Semiconductor<sup>®</sup>

[www.onsemi.com](http://www.onsemi.com)

**SOT-23  
DUAL BIDIRECTIONAL  
VOLTAGE SUPPRESSOR  
350 W PEAK POWER**

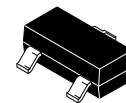

**SOT-23  
CASE 318  
STYLE 27**

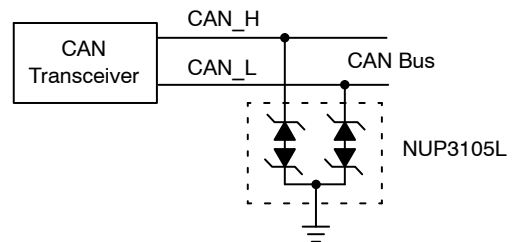
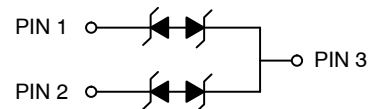

#### MARKING DIAGRAM

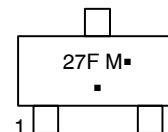

27F = Device Code  
M = Date Code  
▪ = Pb-Free Package

(Note: Microdot may be in either location)

#### ORDERING INFORMATION

See detailed ordering and shipping information in the package dimensions section on page 3 of this data sheet.

# NUP3105L, SZNUP3105L

## MAXIMUM RATINGS ( $T_J = 25^\circ\text{C}$ , unless otherwise specified)

Symbol	Rating	Value	Unit
PPK	Peak Power Dissipation 8 x 20 $\mu\text{s}$ Double Exponential Waveform (Note 1)	350	W
$T_J$	Operating Junction Temperature Range	-55 to 150	$^\circ\text{C}$
$T_J$	Storage Temperature Range	-55 to 150	$^\circ\text{C}$
$T_L$	Lead Solder Temperature (10 s)	260	$^\circ\text{C}$
ESD	Human Body model (HBM) Machine Model (MM) IEC 61000-4-2 Specification (Contact)	8.0 400 30	kV V kV

Stresses exceeding those listed in the Maximum Ratings table may damage the device. If any of these limits are exceeded, device functionality should not be assumed, damage may occur and reliability may be affected.

1. Non-repetitive current pulse per Figure 1.

## ELECTRICAL CHARACTERISTICS ( $T_J = 25^\circ\text{C}$ , unless otherwise specified)

Symbol	Parameter	Test Conditions	Min	Typ	Max	Unit
$V_{RWM}$	Reverse Working Voltage	(Note 2)	-	-	32	V
$V_{BR}$	Breakdown Voltage	$I_T = 1\text{ mA}$ (Note 3)	35.6	-	-	V
$I_R$	Reverse Leakage Current	$V_{RWM} = 32\text{ V}$	-	-	100	nA
$V_C$	Clamping Voltage	$I_{PP} = 5\text{ A}$ (8/20 $\mu\text{s}$ Waveform) (Note 4)	-	-	59	V
$V_C$	Clamping Voltage	$I_{PP} = 8\text{ A}$ (8/20 $\mu\text{s}$ Waveform) (Note 4)	-	-	66	V
$I_{PP}$	Maximum Peak Pulse Current	8/20 $\mu\text{s}$ Waveform (Note 4)	-	-	8.0	A
CJ	Capacitance	$V_R = 0\text{ V}$ , $f = 1\text{ MHz}$ (Line to GND)	-	-	30	pF

Product parametric performance is indicated in the Electrical Characteristics for the listed test conditions, unless otherwise noted. Product performance may not be indicated by the Electrical Characteristics if operated under different conditions.

2. Surge protection devices are normally selected according to the working peak reverse voltage ( $V_{RWM}$ ), which should be equal or greater than the DC or continuous peak operating voltage level.
3.  $V_{BR}$  is measured at pulse test current  $I_T$ .
4. Pulse waveform per Figure 1.

## TYPICAL PERFORMANCE CURVES

( $T_J = 25^\circ\text{C}$  unless otherwise noted)

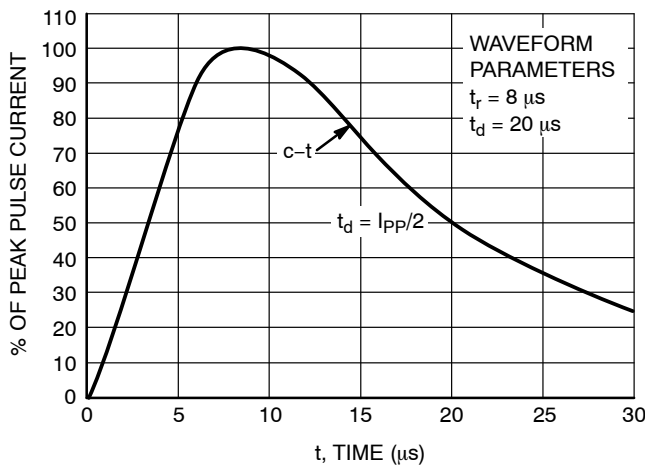

Figure 1. Pulse Waveform, 8/20  $\mu\text{s}$

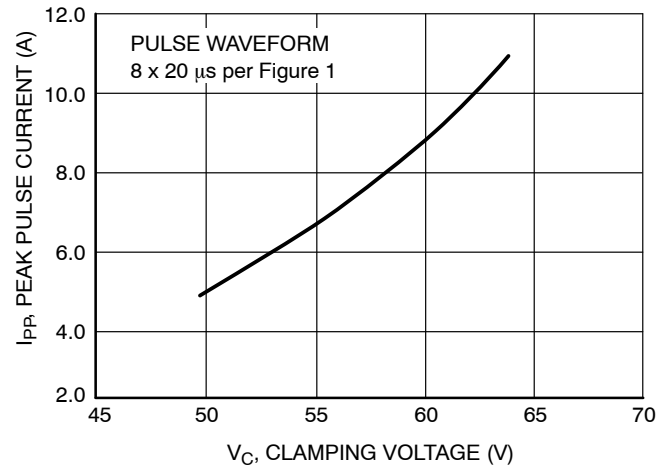

Figure 2. Clamping Voltage vs Peak Pulse Current

## NUP3105L, SZNUP3105L

### Surge Protection Diode Protection Circuit

Surge protection diodes provide protection to a transceiver by clamping a surge voltage to a safe level. surge protection diodes have high impedance below and low impedance above their breakdown voltage. A surge protection Zener diode has its junction optimized to absorb the high peak energy of a transient event, while a standard Zener diode is designed and specified to clamp a steady state voltage.

Figure 3 provides an example of a dual bidirectional surge protection diode array that can be used for protection with the high-speed CAN network. The bidirectional array is created from four identical Zener surge protection diodes. The clamping voltage of the composite device is equal to the

breakdown voltage of the diode that is reversed biased, plus the diode drop of the second diode that is forward biased.

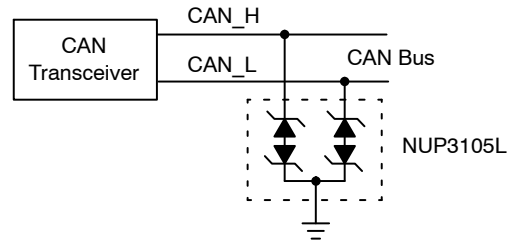

**Figure 3. High-Speed and Fault Tolerant CAN Surge Protection Circuit**

### ORDERING INFORMATION

Device	Package	Shipping <sup>†</sup>
NUP3105LT1G	SOT-23 (Pb-Free)	3,000 / Tape & Reel
SZNUP3105LT1G*	SOT-23 (Pb-Free)	3,000 / Tape & Reel
NUP3105LT3G	SOT-23 (Pb-Free)	10,000 / Tape & Reel
SZNUP3105LT3G*	SOT-23 (Pb-Free)	10,000 / Tape & Reel

<sup>†</sup>For information on tape and reel specifications, including part orientation and tape sizes, please refer to our Tape and Reel Packaging Specifications Brochure, BRD8011/D.

\*SZ Prefix for Automotive and Other Applications Requiring Unique Site and Control Change Requirements; AEC-Q101 Qualified and PPAP Capable.

# NUP3105L, SZNUP3105L

## PACKAGE DIMENSIONS

SOT-23 (TO-236)  
CASE 318-08  
ISSUE AR

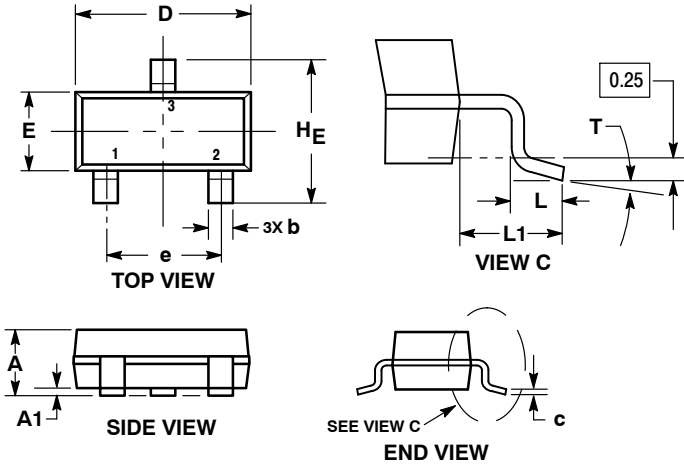

NOTES:

1. DIMENSIONING AND TOLERANCING PER ASME Y14.5M, 1994.
2. CONTROLLING DIMENSION: MILLIMETERS.
3. MAXIMUM LEAD THICKNESS INCLUDES LEAD FINISH. MINIMUM LEAD THICKNESS IS THE MINIMUM THICKNESS OF THE BASE MATERIAL.
4. DIMENSIONS D AND E DO NOT INCLUDE MOLD FLASH, PROTRUSIONS, OR GATE BURRS.

DIM	MILLIMETERS			INCHES		
	MIN	NOM	MAX	MIN	NOM	MAX
A	0.89	1.00	1.11	0.035	0.039	0.044
A1	0.01	0.06	0.10	0.000	0.002	0.004
b	0.37	0.44	0.50	0.015	0.017	0.020
c	0.08	0.14	0.20	0.003	0.006	0.008
D	2.80	2.90	3.04	0.110	0.114	0.120
E	1.20	1.30	1.40	0.047	0.051	0.055
e	1.78	1.90	2.04	0.070	0.075	0.080
L	0.30	0.43	0.55	0.012	0.017	0.022
L1	0.35	0.54	0.69	0.014	0.021	0.027
HE	2.10	2.40	2.64	0.083	0.094	0.104
T	0°	---	10°	0°	---	10°

STYLE 27:  
PIN 1. CATHODE  
PIN 2. CATHODE  
PIN 3. CATHODE

### RECOMMENDED SOLDERING FOOTPRINT\*

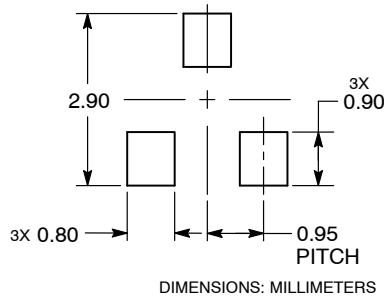

\*For additional information on our Pb-Free strategy and soldering details, please download the ON Semiconductor Soldering and Mounting Techniques Reference Manual, SOLDERRM/D.

Honeywell and SDS are registered trademarks of Honeywell International Inc.  
DeviceNet is a trademark of Rockwell Automation.

ON Semiconductor and are trademarks of Semiconductor Components Industries, LLC dba ON Semiconductor or its subsidiaries in the United States and/or other countries. ON Semiconductor owns the rights to a number of patents, trademarks, copyrights, trade secrets, and other intellectual property. A listing of ON Semiconductor's product/patent coverage may be accessed at [www.onsemi.com/site/pdf/Patent-Marking.pdf](http://www.onsemi.com/site/pdf/Patent-Marking.pdf). ON Semiconductor reserves the right to make changes without further notice to any products herein. ON Semiconductor makes no warranty, representation or guarantee regarding the suitability of its products for any particular purpose, nor does ON Semiconductor assume any liability arising out of the application or use of any product or circuit, and specifically disclaims any and all liability, including without limitation special, consequential or incidental damages. Buyer is responsible for its products and applications using ON Semiconductor products, including compliance with all laws, regulations and safety requirements or standards, regardless of any support or applications information provided by ON Semiconductor. "Typical" parameters which may be provided in ON Semiconductor data sheets and/or specifications can and do vary in different applications and actual performance may vary over time. All operating parameters, including "Typicals" must be validated for each customer application by customer's technical experts. ON Semiconductor does not convey any license under its patent rights nor the rights of others. ON Semiconductor products are not designed, intended, or authorized for use as a critical component in life support systems or any FDA Class 3 medical devices or medical devices with a same or similar classification in a foreign jurisdiction or any devices intended for implantation in the human body. Should Buyer purchase or use ON Semiconductor products for any such unintended or unauthorized application, Buyer shall indemnify and hold ON Semiconductor and its officers, employees, subsidiaries, affiliates, and distributors harmless against all claims, costs, damages, and expenses, and reasonable attorney fees arising out of, directly or indirectly, any claim of personal injury or death associated with such unintended or unauthorized use, even if such claim alleges that ON Semiconductor was negligent regarding the design or manufacture of the part. ON Semiconductor is an Equal Opportunity/Affirmative Action Employer. This literature is subject to all applicable copyright laws and is not for resale in any manner.

### PUBLICATION ORDERING INFORMATION

**LITERATURE FULFILLMENT:**  
Literature Distribution Center for ON Semiconductor  
19521 E. 32nd Pkwy, Aurora, Colorado 80011 USA  
**Phone:** 303-675-2175 or 800-344-3860 Toll Free USA/Canada  
**Fax:** 303-675-2176 or 800-344-3867 Toll Free USA/Canada  
**Email:** [orderlit@onsemi.com](mailto:orderlit@onsemi.com)

**N. American Technical Support:** 800-282-9855 Toll Free  
USA/Canada  
**Europe, Middle East and Africa Technical Support:**  
Phone: 421 33 790 2910  
**Japan Customer Focus Center**  
Phone: 81-3-5817-1050

**ON Semiconductor Website:** [www.onsemi.com](http://www.onsemi.com)  
**Order Literature:** <http://www.onsemi.com/orderlit>

For additional information, please contact your local Sales Representative

Компания «Океан Электроники» предлагает заключение долгосрочных отношений при поставках импортных электронных компонентов на взаимовыгодных условиях!

Наши преимущества:

- Поставка оригинальных импортных электронных компонентов напрямую с производств Америки, Европы и Азии, а так же с крупнейших складов мира;
- Широкая линейка поставок активных и пассивных импортных электронных компонентов (более 30 млн. наименований);
- Поставка сложных, дефицитных, либо снятых с производства позиций;
- Оперативные сроки поставки под заказ (от 5 рабочих дней);
- Экспресс доставка в любую точку России;
- Помощь Конструкторского Отдела и консультации квалифицированных инженеров;
- Техническая поддержка проекта, помощь в подборе аналогов, поставка прототипов;
- Поставка электронных компонентов под контролем ВП;
- Система менеджмента качества сертифицирована по Международному стандарту ISO 9001;
- При необходимости вся продукция военного и аэрокосмического назначения проходит испытания и сертификацию в лаборатории (по согласованию с заказчиком);
- Поставка специализированных компонентов военного и аэрокосмического уровня качества (Xilinx, Altera, Analog Devices, Intersil, Interpoint, Microsemi, Actel, Aeroflex, Peregrine, VPT, Syfer, Eurofarad, Texas Instruments, MS Kennedy, Miteq, Cobham, E2V, MA-COM, Hittite, Mini-Circuits, General Dynamics и др.);

Компания «Океан Электроники» является официальным дистрибьютором и эксклюзивным представителем в России одного из крупнейших производителей разъемов военного и аэрокосмического назначения «JONHON», а так же официальным дистрибьютором и эксклюзивным представителем в России производителя высокотехнологичных и надежных решений для передачи СВЧ сигналов «FORSTAR».



## JONHON

«JONHON» (основан в 1970 г.)

Разъемы специального, военного и аэрокосмического назначения:

(Применяются в военной, авиационной, аэрокосмической, морской, железнодорожной, горно- и нефтедобывающей отраслях промышленности)

«FORSTAR» (основан в 1998 г.)

ВЧ соединители, коаксиальные кабели,  
кабельные сборки и микроволновые компоненты:

(Применяются в телекоммуникациях гражданского и специального назначения, в средствах связи, РЛС, а так же военной, авиационной и аэрокосмической отраслях промышленности).



Телефон: 8 (812) 309-75-97 (многоканальный)

Факс: 8 (812) 320-03-32

Электронная почта: [ocean@oceanchips.ru](mailto:ocean@oceanchips.ru)

Web: <http://oceanchips.ru/>

Адрес: 198099, г. Санкт-Петербург, ул. Калинина, д. 2, корп. 4, лит. А