

40V_{IN}, 2.5A Silent Switcher µModule Regulator

FEATURES

- Complete Step-Down Switch Mode Power Supply
- Low Noise Silent Switcher® Architecture
- Wide Input Voltage Range: 3.4V to 40V
- Wide Output Voltage Range: 0.97V to 18V
- 2.5A Continuous Output Current, 3.5A Peak
- Selectable Switching Frequency: 200kHz to 3MHz
- External Synchronization
- Programmable Soft-Start
- Tiny, Low Profile 6.25mm × 6.25mm × 2.32mm
RoHS Compliant BGA Package

APPLICATIONS

- Automotive Battery Regulation
- Power for Portable Products
- Distributed Supply Regulation
- Industrial Supplies
- Wall Transformer Regulation

DESCRIPTION

The LTM®8065 is a 40V_{IN}, 3.5A peak, 2.5A continuous step-down µModule® (power module) regulator. Included in the package are the switching controller, power switches, inductor and all support components. Operating over an input voltage range of 3.4V to 40V, the LTM8065 supports an output voltage range of 0.97V to 18V and a switching frequency range of 200kHz to 3MHz, each set by a single resistor. Only the input and output filter capacitors are needed to finish the design.

The low profile package enables utilization of unused space on the bottom of PC boards for high density point of load regulation. The LTM8065 is packaged in a thermally enhanced, compact over-molded ball grid array (BGA) package suitable for automated assembly by standard surface mount equipment. The LTM8065 is RoHS compliant.

All registered trademarks and trademarks are the property of their respective owners.

TYPICAL APPLICATION

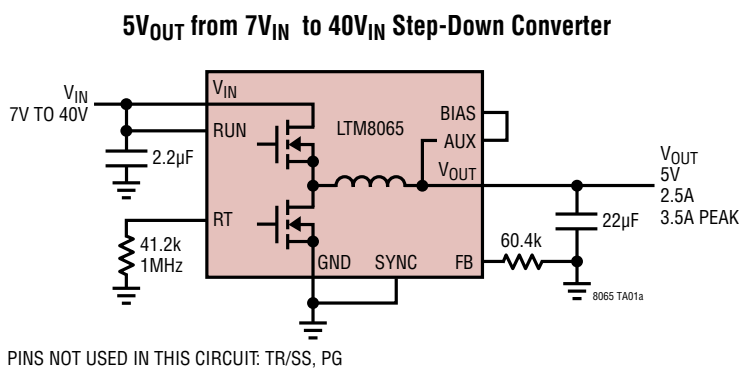

Efficiency vs Load Current

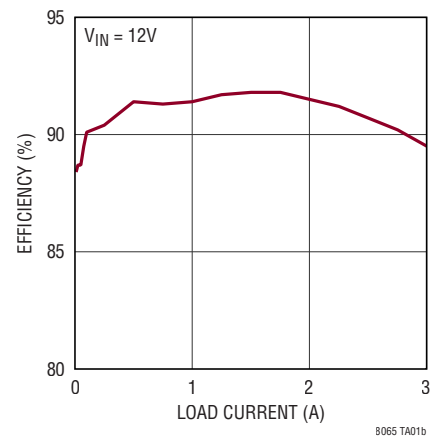

LTM8065

ABSOLUTE MAXIMUM RATINGS

(Notes 1, 2)

V_{IN} , RUN, PG Voltage	42V
AUX, V_{OUT} , BIAS Voltage	19V
FB, TR/SS Voltage	4V
SYNC Voltage	6V
Maximum Internal Temperature	125°C
Storage Temperature	-55°C to 125°C
Peak Reflow Solder Body Temperature	260°C

PIN CONFIGURATION

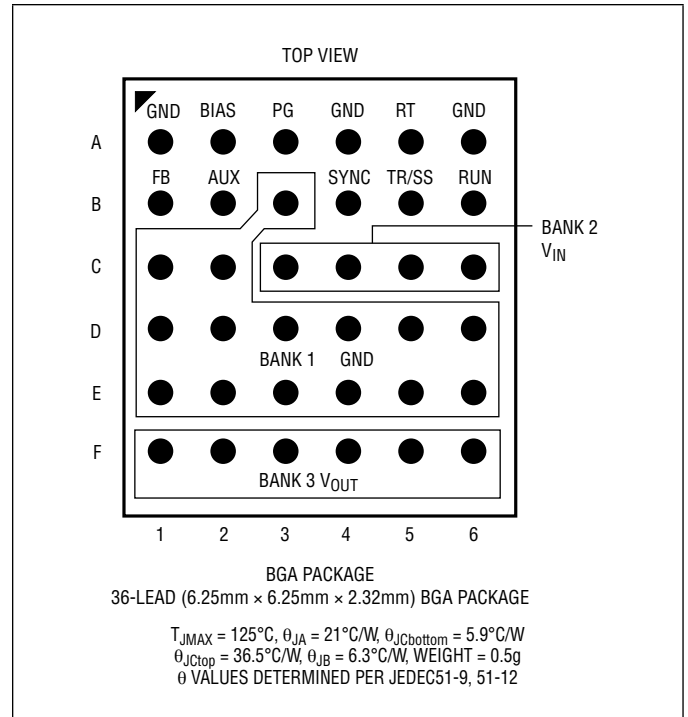

ORDER INFORMATION

PART NUMBER	TERMINAL FINISH	PART MARKING*		PACKAGE TYPE	MSL RATING	TEMPERATURE RANGE
		DEVICE	FINISH CODE			
LTM8065EY#PBF	SAC305 (RoHS)	LTM8065	e1	BGA	3	-40°C to 125°C
LTM8065IY#PBF						

- Contact the factory for parts specified with wider operating temperature ranges. *Pad or ball finish code is per IPC/JEDEC J-STD-609.
- [Recommended LGA and BGA PCB Assembly and Manufacturing Procedures](#)
- [LGA and BGA Package and Tray Drawings](#)

ELECTRICAL CHARACTERISTICS

The ● denotes the specifications which apply over the specified operating temperature range, otherwise specifications are at $T_J = 25^\circ\text{C}$. $V_{IN} = 12\text{V}$, $\text{RUN} = 2\text{V}$, unless otherwise noted.

PARAMETER	CONDITIONS	MIN	TYP	MAX	UNITS
Minimum Input Voltage	V_{IN} Rising ●			3.4	V
Output DC Voltage	R_{FB} Open $R_{FB} = 14.3\text{k}\Omega$, $V_{IN} = 40\text{V}$		0.97 18		V V
Peak Output DC Current	$V_{OUT} = 3.3\text{V}$, $f_{SW} = 1\text{MHz}$	3.5			A
Quiescent Current into V_{IN}	$\text{RUN} = 0\text{V}$ $\text{BIAS} = 0\text{V}$, No Load, $\text{SYNC} = 0\text{V}$, Not Switching			3 8	μA μA
Quiescent Current into BIAS	$\text{BIAS} = 5\text{V}$, $\text{RUN} = 0\text{V}$ $\text{BIAS} = 5\text{V}$, No Load, $\text{SYNC} = 0\text{V}$, Not Switching $\text{BIAS} = 5\text{V}$, $V_{OUT} = 3.3\text{V}$, $I_{OUT} = 2.5\text{A}$, $f_{SW} = 1\text{MHz}$			1 5 12	μA μA mA
Line Regulation	$5.5\text{V} < V_{IN} < 36\text{V}$, $I_{OUT} = 1\text{A}$		0.5		%
Load Regulation	$0.1\text{A} < I_{OUT} < 2.5\text{A}$		0.5		%
Output Voltage Ripple	$I_{OUT} = 2.5\text{A}$		10		mV
Switching Frequency	$R_T = 232\text{k}\Omega$ $R_T = 41.2\text{k}\Omega$ $R_T = 10.7\text{k}\Omega$		200 1 3		kHz MHz MHz
Voltage at FB	●	950	970	980	mV
Minimum BIAS Voltage	(Note 5)			3.2	V
RUN Threshold Voltage		0.9		1.06	V
RUN Current				1	μA
TR/SS Current	$\text{TR/SS} = 0\text{V}$		2		μA
TR/SS Pull Down	$\text{TR/SS} = 0.1\text{V}$		200		Ω
PG Threshold Voltage at FB (Upper)	FB Falling (Note 6)		1.05		V
PG Threshold Voltage at FB (Lower)	FB Rising (Note 6)		0.89		V
PG Leakage Current	$\text{PG} = 42\text{V}$			1	μA
PG Sink Current	$\text{PG} = 0.1\text{V}$		150		μA
SYNC Threshold Voltage	Synchronization	0.4		1.5	V
SYNC Voltage	To Enable Spread Spectrum	2.9		4.2	V
SYNC Current	$\text{SYNC} = 0\text{V}$			35	μA

Note 1: Stresses beyond those listed under Absolute Maximum Ratings may cause permanent damage to the device. Exposure to any Absolute Maximum Rating condition for extended periods may affect device reliability and lifetime.

Note 2: Unless otherwise noted, the absolute minimum voltage is zero.

Note 3: The LTM8065E is guaranteed to meet performance specifications from 0°C to 125°C internal. Specifications over the full -40°C to 125°C internal operating temperature range are assured by design, characterization and correlation with statistical process controls. The LTM8065I is guaranteed to meet specifications over the full -40°C to 125°C internal operating temperature range. Note that the maximum internal temperature is determined by specific operating conditions in conjunction with board layout, the rated package thermal resistance and other environmental factors.

Note 4: The LTM8065 contains overtemperature protection that is intended to protect the device during momentary overload conditions. The internal temperature exceeds the maximum operating junction temperature when the overtemperature protection is active. Continuous operation above the specified maximum operating junction temperature may impair device reliability.

Note 5: Below this specified voltage, internal circuitry will draw power from V_{IN} .

Note 6: PG transitions from low to high.

TYPICAL PERFORMANCE CHARACTERISTICS $T_A = 25^\circ\text{C}$, unless otherwise noted.

**Efficiency, $V_{OUT} = 0.97\text{V}$,
BIAS = 5V**

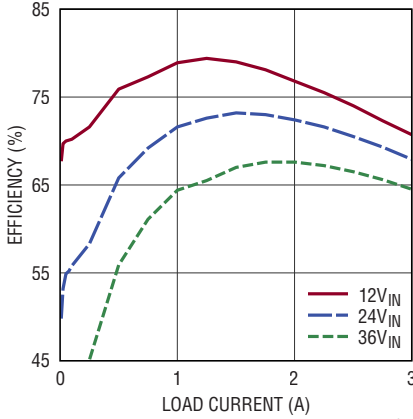

**Efficiency, $V_{OUT} = 1.2\text{V}$,
BIAS = 5V**

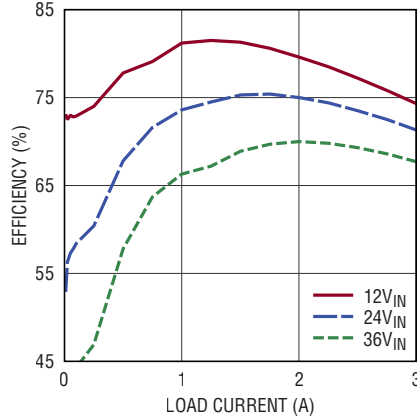

**Efficiency, $V_{OUT} = 1.5\text{V}$,
BIAS = 5V**

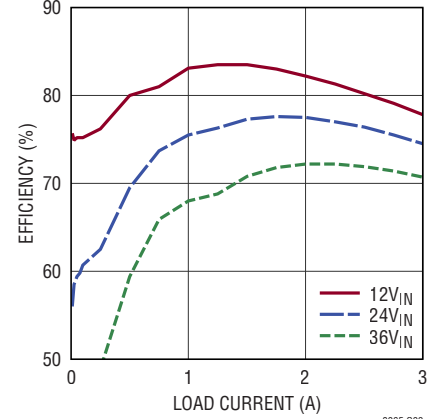

**Efficiency, $V_{OUT} = 1.8\text{V}$,
BIAS = 5V**

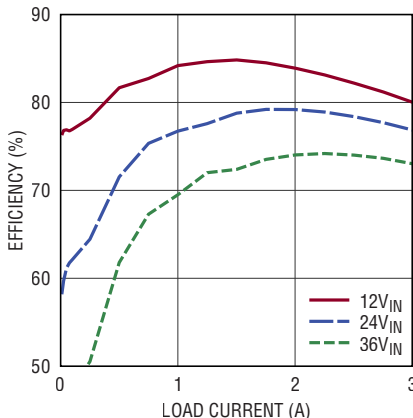

**Efficiency, $V_{OUT} = 2\text{V}$,
BIAS = 5V**

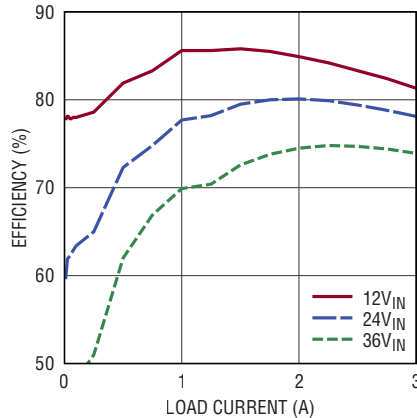

**Efficiency, $V_{OUT} = 2.5\text{V}$,
BIAS = 5V**

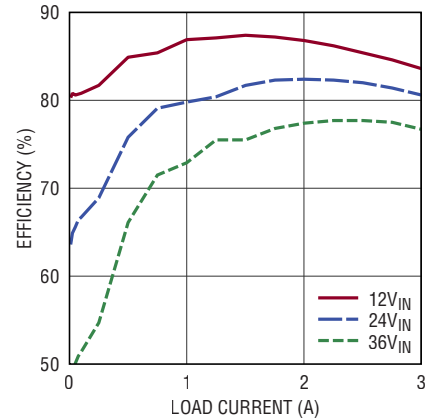

**Efficiency, $V_{OUT} = 3.3\text{V}$,
BIAS = 5V**

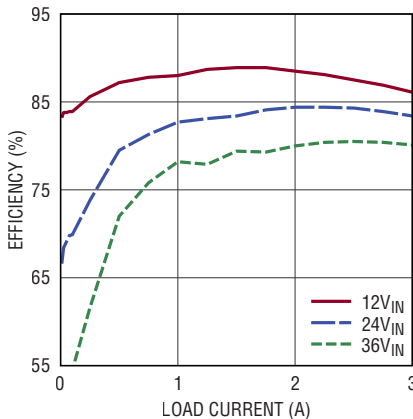

**Efficiency, $V_{OUT} = 5\text{V}$,
BIAS = 5V**

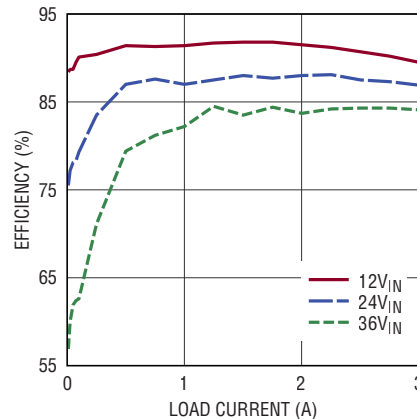

**Efficiency, $V_{OUT} = 8\text{V}$,
BIAS = 5V**

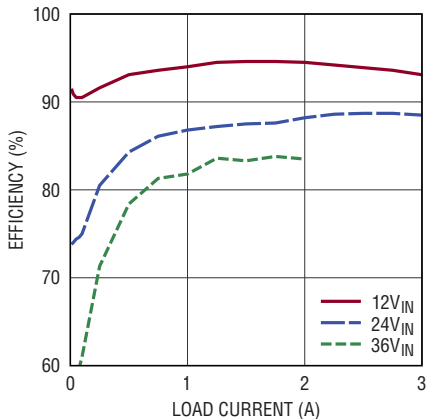

TYPICAL PERFORMANCE CHARACTERISTICS $T_A = 25^\circ\text{C}$, unless otherwise noted.

**Efficiency, $V_{OUT} = 12\text{V}$,
BIAS = 5V**

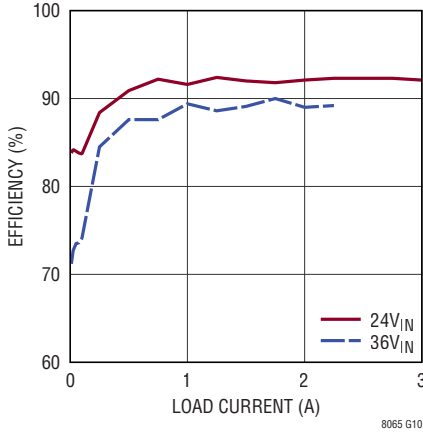

8065 G10

**Efficiency, $V_{OUT} = 15\text{V}$,
BIAS = 5V**

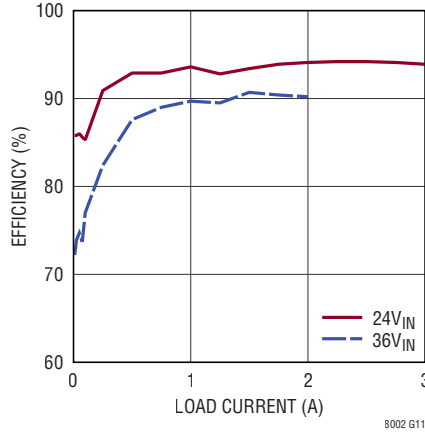

8002 G11

**Efficiency, $V_{OUT} = 18\text{V}$,
BIAS = 5V**

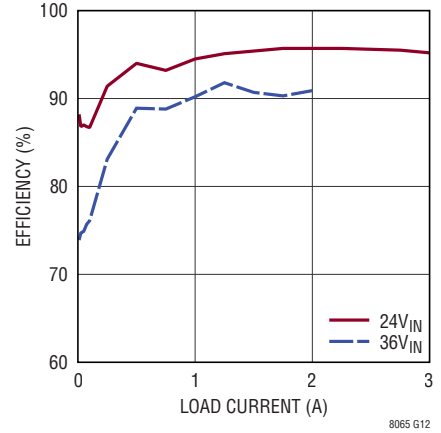

8065 G12

**Efficiency, $V_{OUT} = -3.3\text{V}$,
BIAS tied to LTM8065 GND**

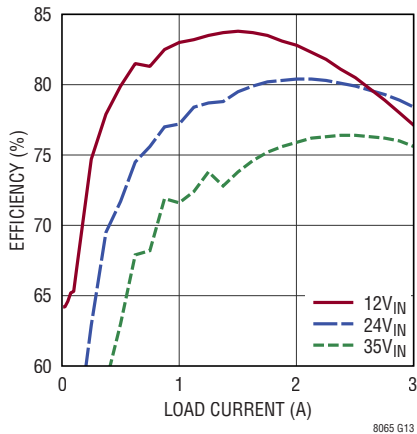

8065 G13

**Efficiency, $V_{OUT} = -5\text{V}$,
BIAS tied to LTM8065 GND**

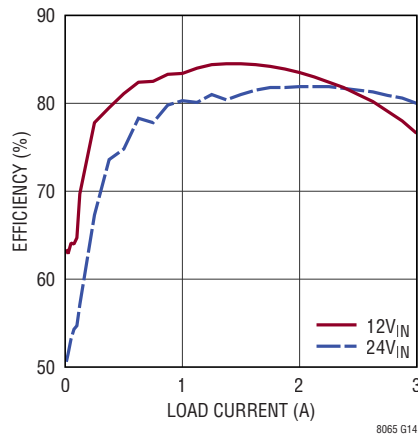

8065 G14

**Efficiency, $V_{OUT} = -8\text{V}$,
BIAS tied to LTM8065 GND**

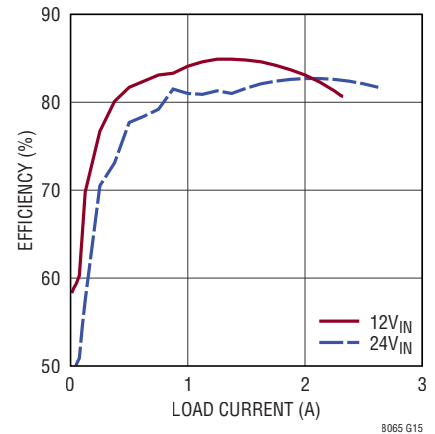

8065 G15

**Efficiency, $V_{OUT} = -12\text{V}$, BIAS tied
to LTM8065 GND**

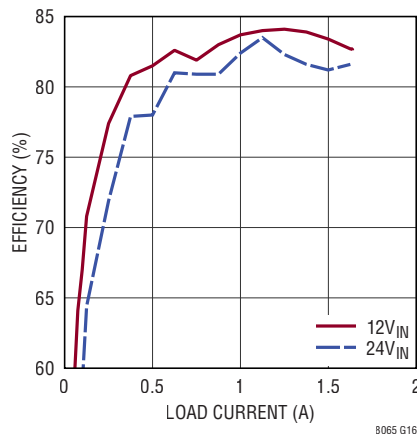

8065 G16

**Efficiency, $V_{OUT} = -15\text{V}$, BIAS tied
to LTM8065 GND**

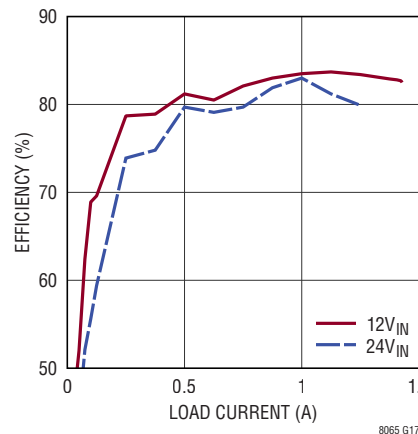

8065 G17

**Efficiency, $V_{OUT} = -18\text{V}$, BIAS tied
to LTM8065 GND**

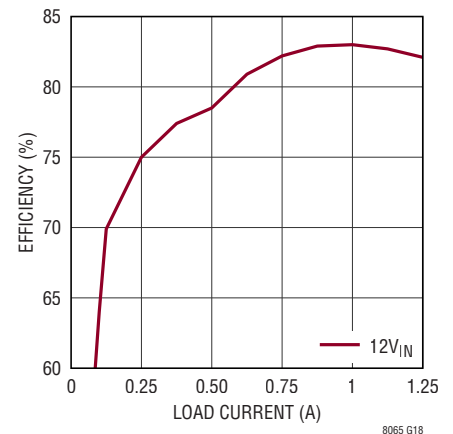

8065 G18

TYPICAL PERFORMANCE CHARACTERISTICS $T_A = 25^\circ\text{C}$, unless otherwise noted.

Input vs Load Current
 $V_{OUT} = 0.97\text{V}$

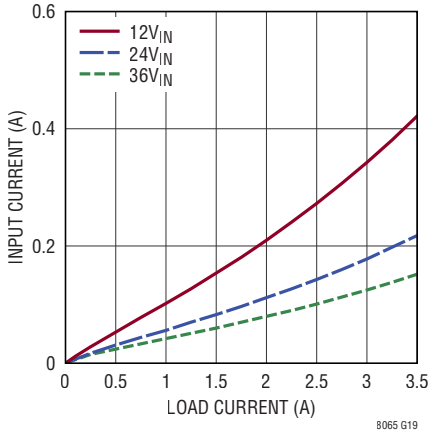

Input vs Load Current
 $V_{OUT} = 1.2\text{V}$

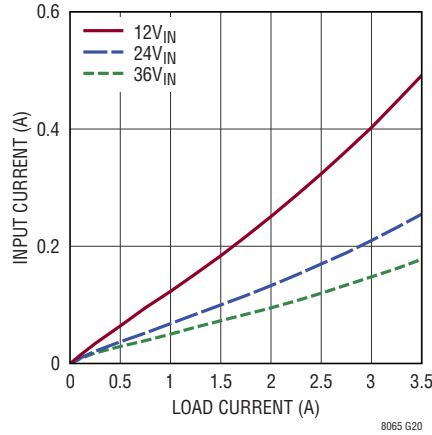

Input vs Load Current
 $V_{OUT} = 1.5\text{V}$

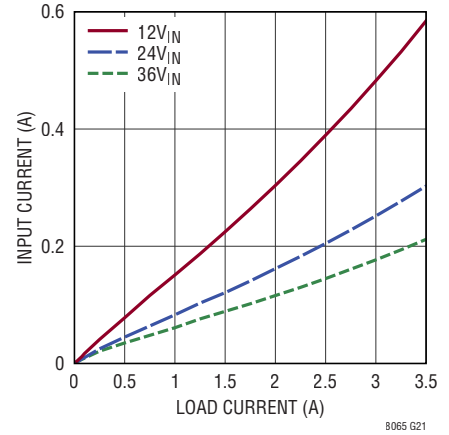

Input vs Load Current
 $V_{OUT} = 1.8\text{V}$

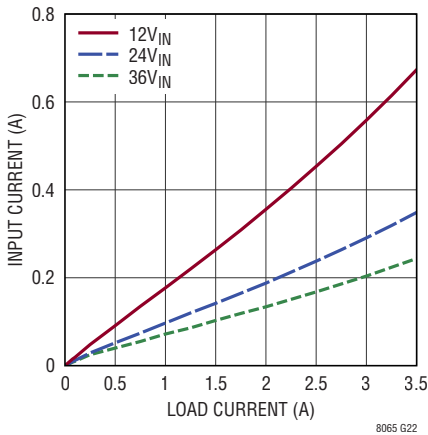

Input vs Load Current
 $V_{OUT} = 2\text{V}$

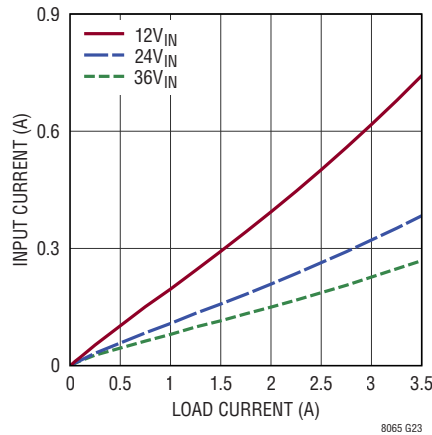

Input vs Load Current
 $V_{OUT} = 2.5\text{V}$

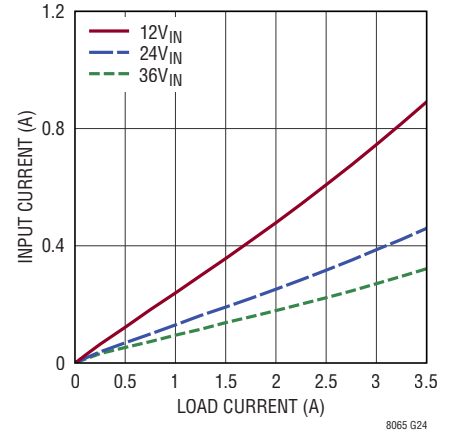

Input vs Load Current
 $V_{OUT} = 3.3\text{V}$

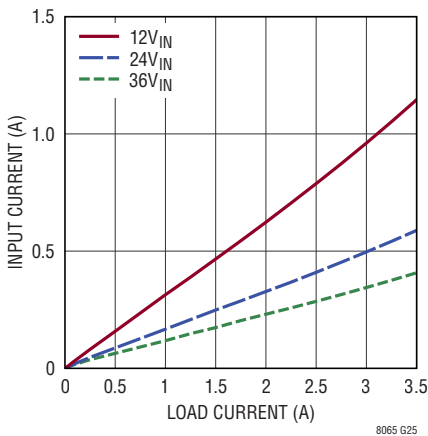

Input vs Load Current
 $V_{OUT} = 5\text{V}$

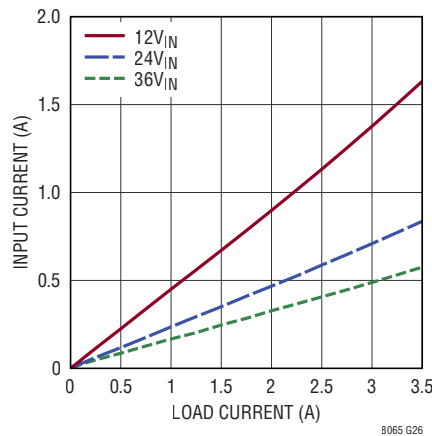

Input vs Load Current
 $V_{OUT} = 8\text{V}$

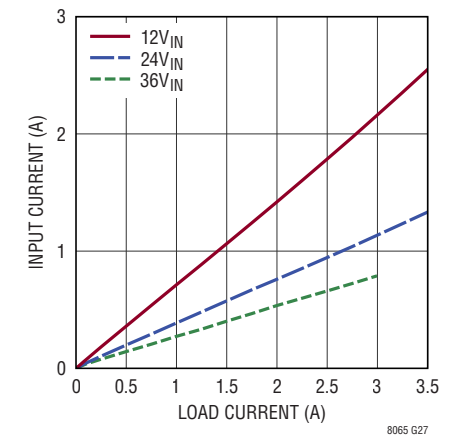

TYPICAL PERFORMANCE CHARACTERISTICS $T_A = 25^\circ\text{C}$, unless otherwise noted.

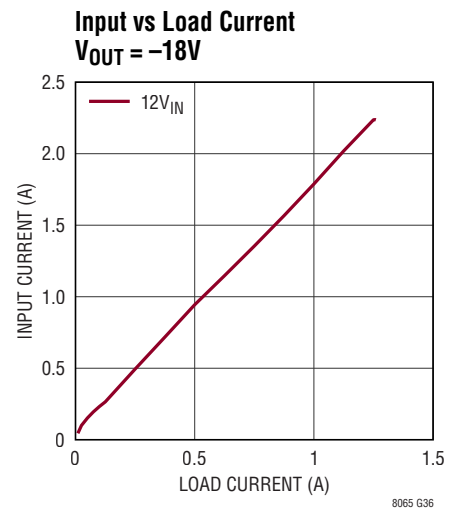
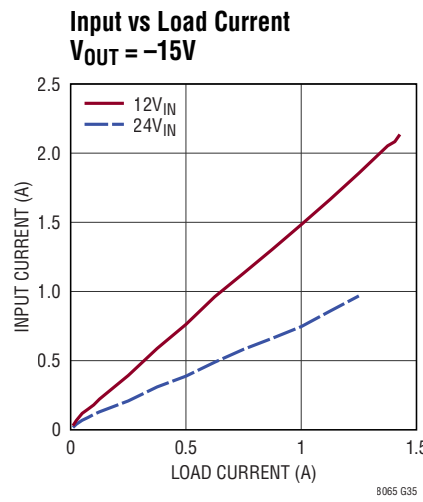
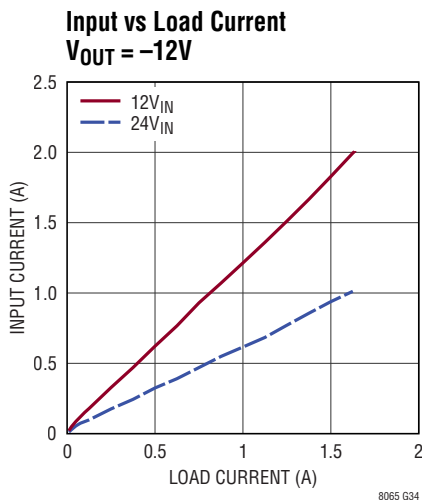
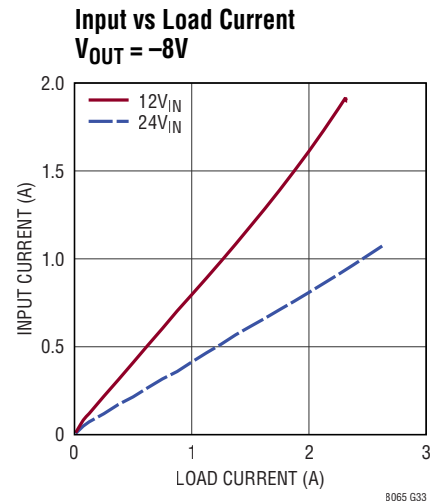
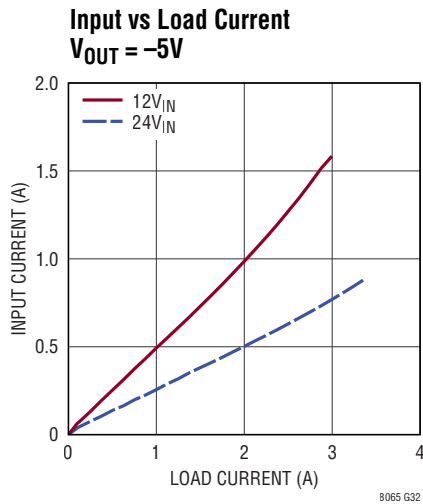
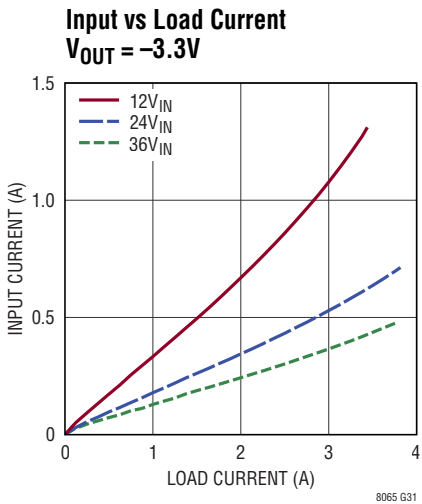
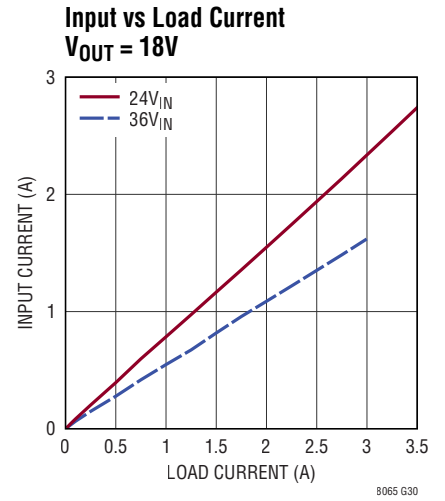
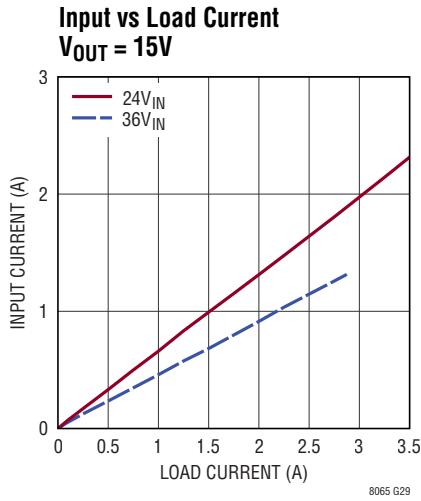
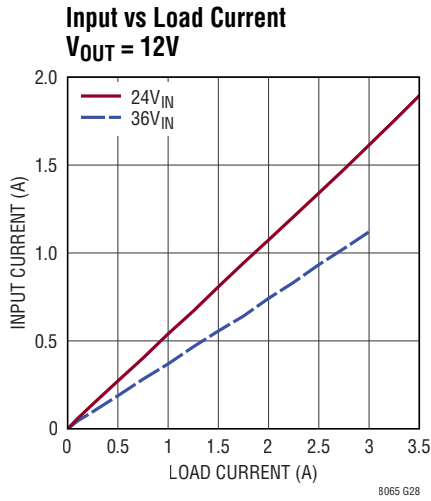

TYPICAL PERFORMANCE CHARACTERISTICS $T_A = 25^\circ\text{C}$, unless otherwise noted.

**Maximum Load Current vs V_{IN}
BIAS tied to LTM8065 GND**

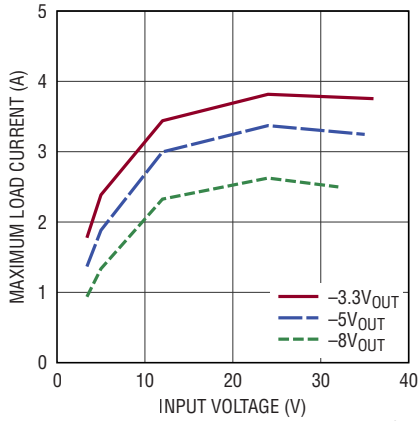

8065 G37

**Maximum Load Current vs V_{IN}
BIAS tied to LTM8065 GND**

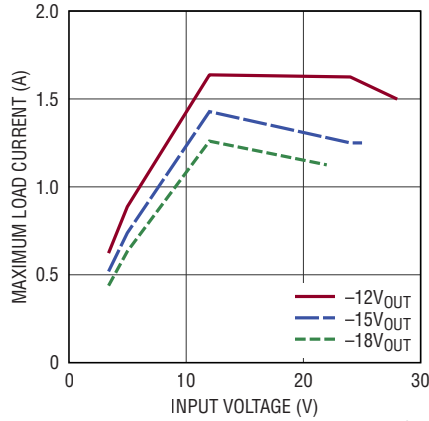

8065 G38

**Derating, $V_{OUT} = 0.97\text{V}$ BIAS = 5V,
DC2251A Demo Board**

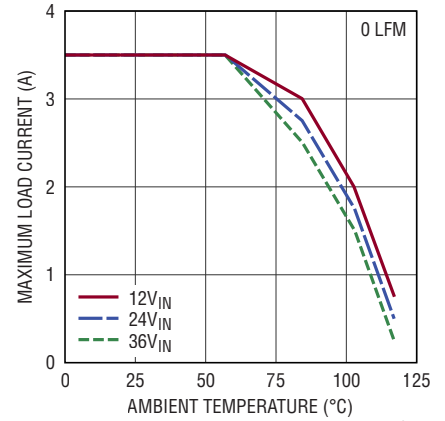

8065 G39

**Derating, $V_{OUT} = 1.2\text{V}$, BIAS = 5V,
DC2251A Demo Board**

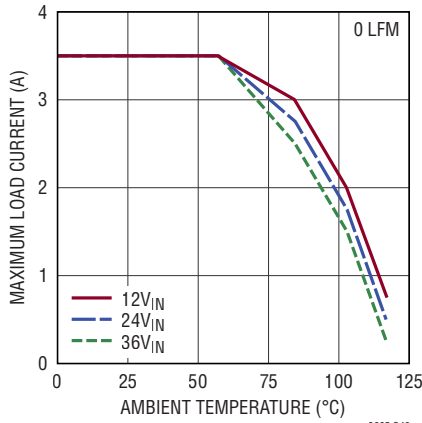

8065 G40

**Derating, $V_{OUT} = 1.5\text{V}$, BIAS = 5V,
DC2251A Demo Board**

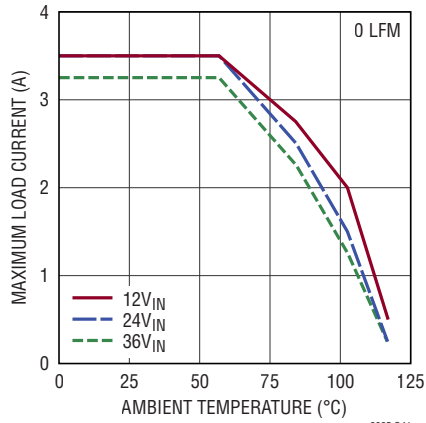

8065 G41

**Derating, $V_{OUT} = 1.8\text{V}$, BIAS = 5V,
DC2251A Demo Board**

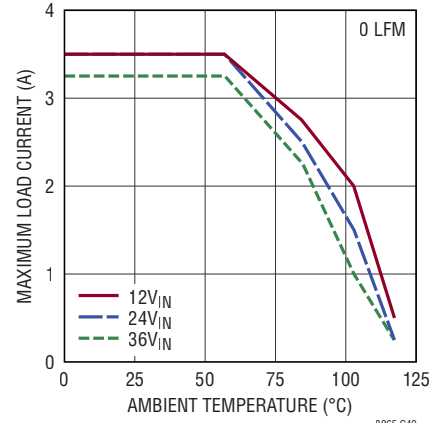

8065 G42

**Derating, $V_{OUT} = 2\text{V}$, BIAS = 5V,
DC2251A Demo Board**

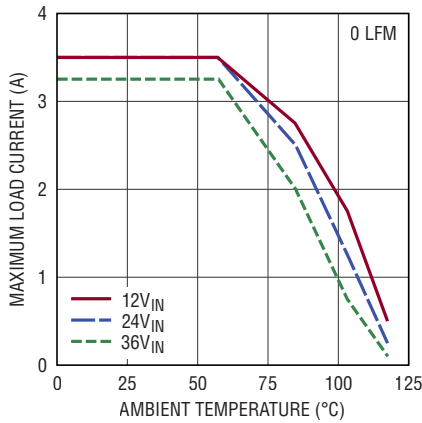

8065 G43

**Derating, $V_{OUT} = 2.5\text{V}$, BIAS = 5V,
DC2251A Demo Board**

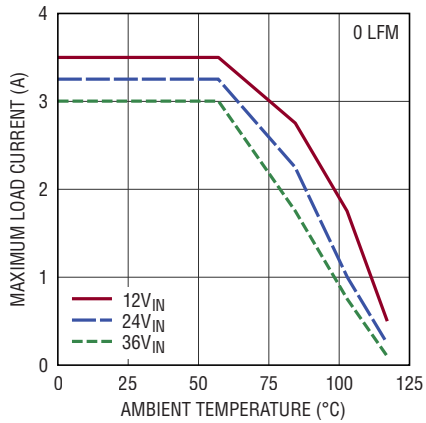

8065 G44

**Derating, $V_{OUT} = 3.3\text{V}$, BIAS = 5V,
DC2251A Demo Board**

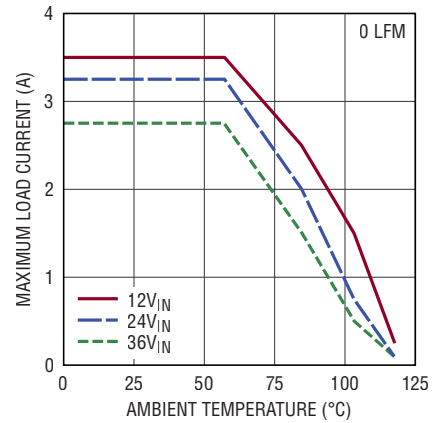

8065 G45

TYPICAL PERFORMANCE CHARACTERISTICS $T_A = 25^\circ\text{C}$, unless otherwise noted.

Derating, $V_{OUT} = 3.3\text{V}$, BIAS = 5V, DC2251A Demo Board

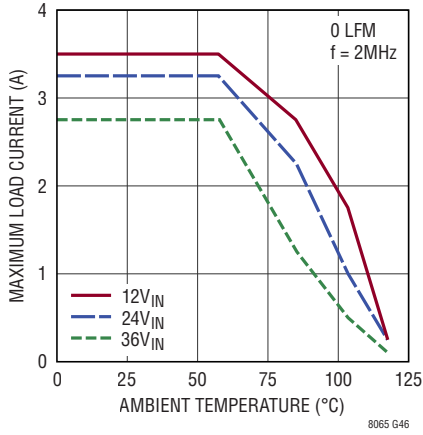

Derating, $V_{OUT} = 5\text{V}$, BIAS = 5V, DC2251A Demo Board

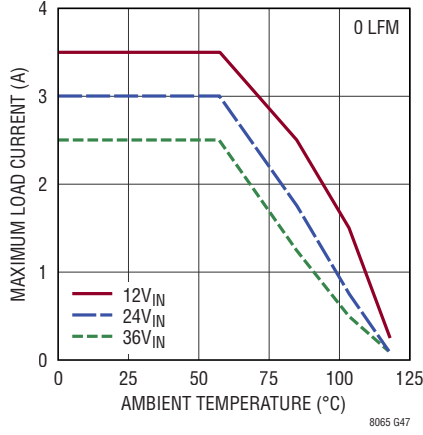

Derating, $V_{OUT} = 5\text{V}$, BIAS = 5V, DC2251A Demo Board

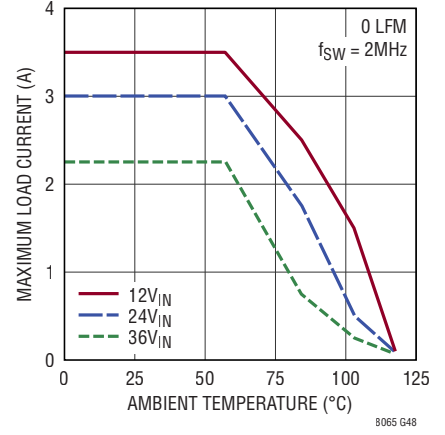

Derating, $V_{OUT} = 8\text{V}$, BIAS = 5V, DC2251A Demo Board

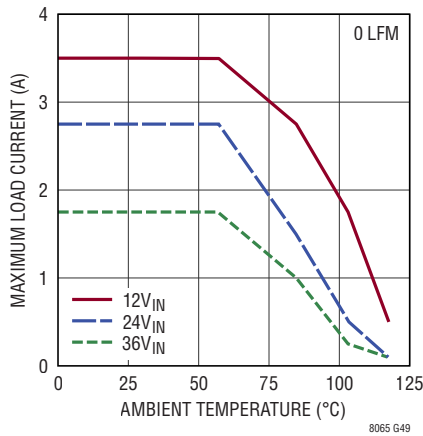

Derating, $V_{OUT} = 12\text{V}$, BIAS = 5V, DC2251A Demo Board

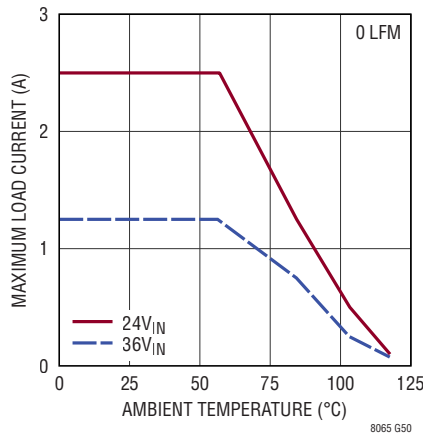

Derating, $V_{OUT} = 15\text{V}$, BIAS = 5V, DC2251A Demo Board

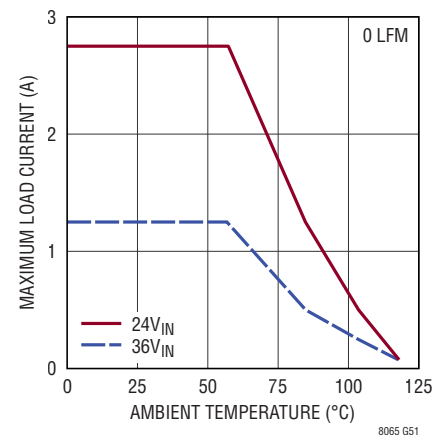

Derating, $V_{OUT} = 18\text{V}$, BIAS = 5V, DC2251A Demo Board

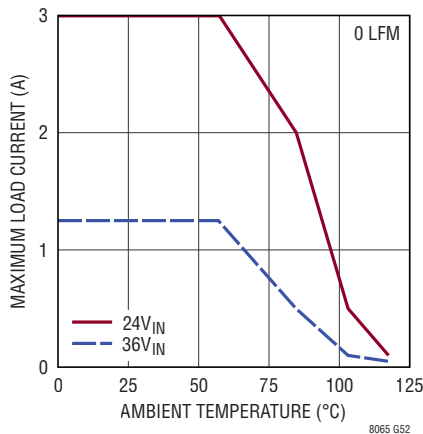

Derating, $V_{OUT} = -3.3\text{V}$, BIAS tied to LTM8065 GND, DC2251A Demo Board

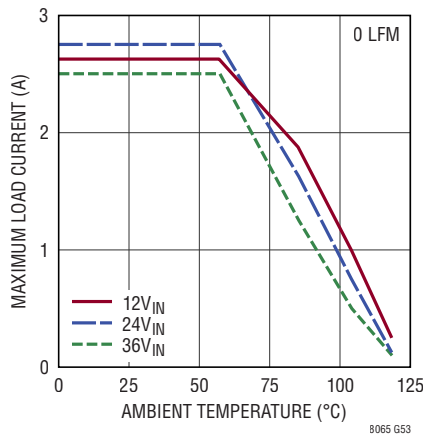

Derating, $V_{OUT} = -5\text{V}$, BIAS tied to LTM8065 GND, DC2251A Demo Board

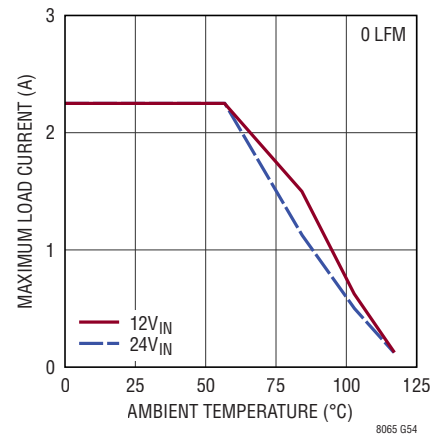

TYPICAL PERFORMANCE CHARACTERISTICS $T_A = 25^\circ\text{C}$, unless otherwise noted.

Derating, $V_{OUT} = -8\text{V}$, BIAS tied to LTM8065 GND, DC2251A Demo Board

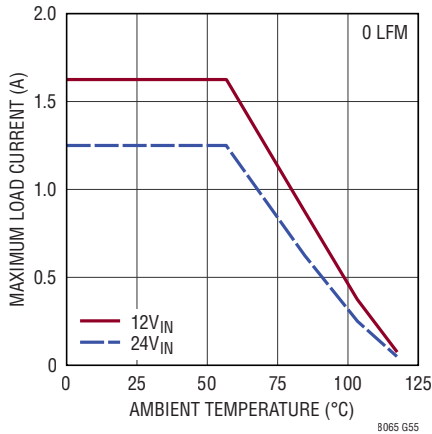

Derating, $V_{OUT} = -12\text{V}$, BIAS tied to LTM8065 GND, DC2251A Demo Board

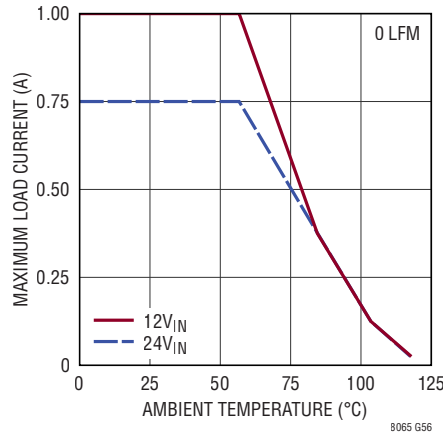

Derating, $V_{OUT} = -15\text{V}$, BIAS tied to LTM8065 GND, DC2251A Demo Board

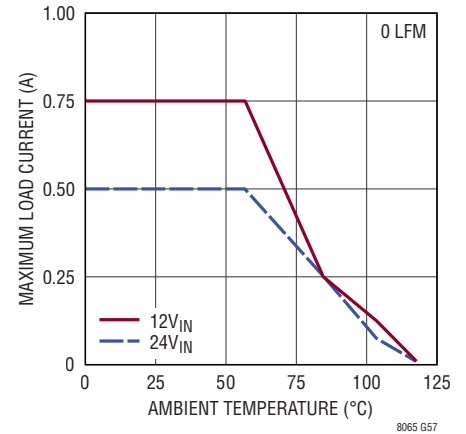

Derating, $V_{OUT} = -18\text{V}$, BIAS tied to LTM8065 GND, DC2251A Demo Board

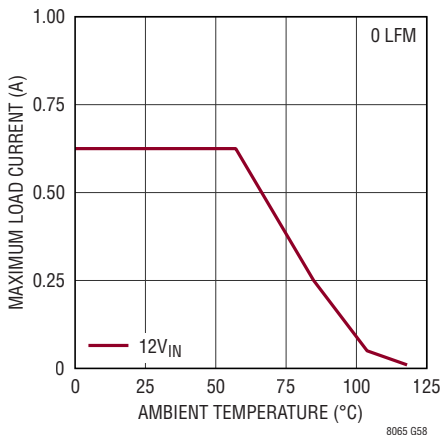

Dropout Voltage vs Load Current, $V_{OUT} = 5\text{V}$, BIAS = 5V

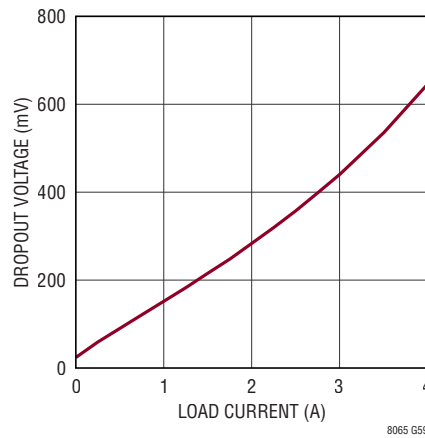

CISPR22 Class B Radiated DC2251A Demo Board, $V_{OUT} = 5\text{V}$ No Filter (FB1, L1 short, C6, C7 open)

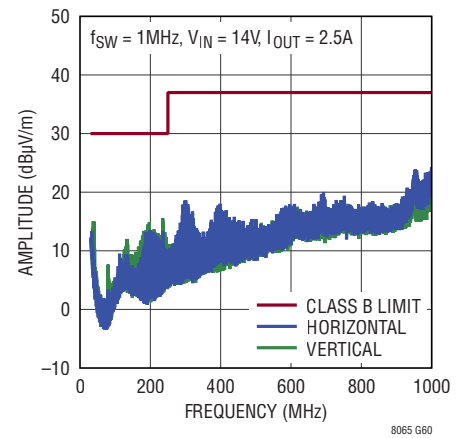

PIN FUNCTIONS

GND (Bank 1, A1, A4, A6): Tie these GND pins to a local ground plane below the LTM8065 and the circuit components. In most applications, the bulk of the heat flow out of the LTM8065 is through these pads, so the printed circuit design has a large impact on the thermal performance of the part. See the PCB Layout and Thermal Considerations sections for more details.

V_{IN} (Bank 2): V_{IN} supplies current to the LTM8065's internal regulator and to the internal power switches. These pins must be locally bypassed with an external, low ESR capacitor; see Table 1 for recommended values.

V_{OUT} (Bank 3): Power Output Pins. Apply the output filter capacitor and the output load between these pins and GND pins.

BIAS (Pin A2): The BIAS pin connects to the internal power bus. Connect to a power source greater than 3.2V. If V_{OUT} is greater than 3.2V, connect this pin to AUX. If the output voltage is less, connect this to a voltage source greater than 3.2V. Decouple this pin with at least 1 μF if the voltage source for BIAS is remote. If unused, tie this pin to GND.

PG (Pin A3): The PG pin is the open-collector output of an internal comparator. PG remains low until the FB pin voltage is within about 10% of the final regulation voltage. The PG signal is valid when V_{IN} is above 3.4V. If V_{IN} is above 3.4V and RUN is low, PG will drive low. If this function is not used, leave this pin floating.

RT (Pin A5): The RT pin is used to program the switching frequency of the LTM8065 by connecting a resistor from this pin to ground. The Applications Information section of the data sheet includes a table to determine the resistance value based on the desired switching frequency. Minimize capacitance at this pin. Do not drive this pin.

FB (Pin B1): The LTM8065 regulates its FB pin to 0.97V. Connect the adjust resistor from this pin to ground. The value of R_{FB} is given by the equation $R_{FB} = 241.53 / (V_{OUT} - 0.97)$, where R_{FB} is in kΩ.

AUX (Pin B2): Low Current Voltage Source for BIAS. In many designs, the BIAS pin is simply connected to V_{OUT}. The AUX pin is internally connected to V_{OUT} and is placed adjacent to the BIAS pin to ease printed circuit board routing. Also, some applications require a feedforward capacitor; it can be connected from AUX to FB for convenient PCB routing. Although this pin is internally connected to V_{OUT}, it is not intended to deliver a high current, so do not draw current from this pin to the load.

SYNC (Pin B4): External clock synchronization input and operational mode. This pin programs four different operating modes:

1. Burst Mode® Operation. Tie this pin to ground for Burst Mode operation at low output loads—this will result in ultralow quiescent current.
2. Pulse-skipping mode. Float this pin for pulse-skipping mode. This mode offers full frequency operation down to low output loads before pulse skipping occurs.
3. Spread spectrum mode. Tie this pin high (between 2.9V and 4.2V) for pulse-skipping mode with spread spectrum modulation.
4. Synchronization mode. Drive this pin with a clock source to synchronize to an external frequency. During synchronization the part will operate in pulse-skipping mode.

TR/SS (Pin B5): The TR/SS pin is used to provide a soft-start or tracking function. The internal 2 μA pull-up current in combination with an external capacitor tied to this pin creates a voltage ramp. If TR/SS is less than 0.97V, the FB voltage tracks to this value. The soft-start ramp time is approximated by the equation $t = 0.485 \cdot C$ where C is in μF. For tracking, tie a resistor divider to this pin from the tracked output. This pin is pulled to ground with an internal MOSFET during shutdown and fault conditions; use a series resistor if driving from a low impedance output. This pin may be left floating if the tracking function is not needed.

RUN (Pin B6): Pull the RUN pin below 0.9V to shut down the LTM8065. Tie to 1.06V or more for normal operation. If the shutdown feature is not used, tie this pin to the V_{IN} pin.

BLOCK DIAGRAM

LTM8065 Block Diagram

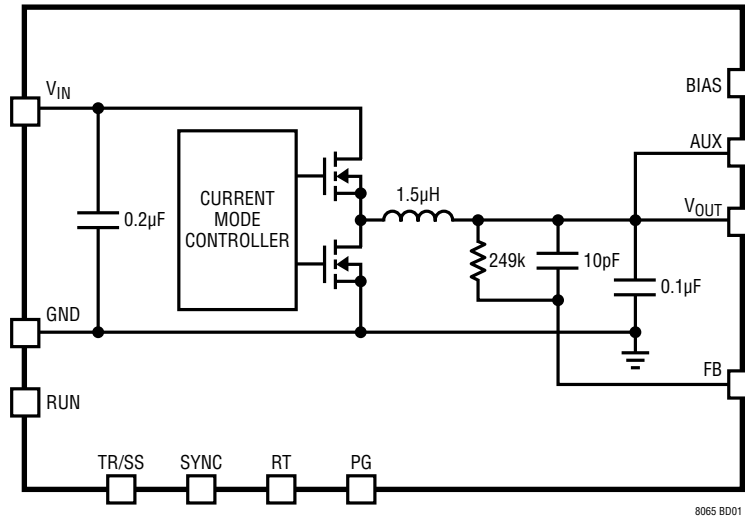

OPERATION

The LTM8065 is a stand-alone non-isolated step-down switching DC/DC power supply that can deliver up to 3.5A. The continuous current is determined by the internal operating temperature. It provides a precisely regulated output voltage programmable via one external resistor from 0.97V to 18V. The input voltage range is 3.4V to 40V. Given that the LTM8065 is a step-down converter, make sure that the input voltage is high enough to support the desired output voltage and load current. A simplified Block Diagram is given on the previous page.

The LTM8065 contains a current mode controller, power switching elements, power inductor and a modest amount of input and output capacitance. The LTM8065 is a fixed frequency PWM regulator. The switching frequency is set by simply connecting the appropriate resistor value from the RT pin to GND.

An internal regulator provides power to the control circuitry. This bias regulator normally draws power from the V_{IN} pin, but if the BIAS pin is connected to an external voltage higher than 3.2V, bias power is drawn from the external source (typically the regulated output voltage). This improves efficiency. If BIAS is unused, tie this pin to GND. The RUN pin is used to place the LTM8065 in shutdown, disconnecting the output and reducing the input current to a few μ A.

To enhance efficiency, the LTM8065 automatically switches to Burst Mode operation in light or no load situations. Between bursts, all circuitry associated with controlling the output switch is shut down reducing the input supply current to just a few μ A.

The oscillator reduces the LTM8065's operating frequency when the voltage at the FB pin is low. This frequency fold-back helps to control the output current during start-up and overload.

The TR/SS node acts as an auxiliary input to the error amplifier. The voltage at FB servos to the TR/SS voltage until TR/SS goes above 0.97V. Soft-start is implemented by generating a voltage ramp at the TR/SS pin using an external capacitor which is charged by an internal constant current. Alternatively, driving the TR/SS pin with a signal source or resistive network provides a tracking function. Do not drive the TR/SS pin with a low impedance voltage source. See the Applications Information section for more details.

The LTM8065 contains a power good comparator which trips when the FB pin is at about 90% to 110% of its regulated value. The PG output is an open-drain transistor that is off when the output is in regulation, allowing an external resistor to pull the PG pin high. The PG signal is valid when V_{IN} is above 3.4V. If V_{IN} is above 3.4V and RUN is low, PG will drive low.

The LTM8065 is equipped with a thermal shutdown that inhibits power switching at high junction temperatures. The activation threshold of this function is above the maximum temperature rating to avoid interfering with normal operation, so prolonged or repetitive operation under a condition in which the thermal shutdown activates may damage or impair the reliability of the device.

APPLICATIONS INFORMATION

For most applications, the design process is straightforward, summarized as follows:

1. Look at Table 1 and find the row that has the desired input range and output voltage.
2. Apply the recommended, C_{IN} , C_{OUT} , R_{FB} and R_T values.
3. Apply the C_{FF} (from AUX to F_B) as required.
4. Connect BIAS as indicated.

While these component combinations have been tested for proper operation, it is incumbent upon the user to verify proper operation over the intended system's line, load and environmental conditions. Bear in mind that the maximum output current is limited by junction temperature, the relationship between the input and output voltage magnitude and polarity and other factors. Please refer to the graphs in the Typical Performance Characteristics section for guidance.

The maximum frequency (and attendant R_T value) at which the LTM8065 should be allowed to switch is given in Table 1 in the Maximum f_{SW} column, while the recommended frequency (and R_T value) for optimal efficiency over the given input condition is given in the f_{SW} column. There are additional conditions that must be satisfied if the synchronization function is used. Please refer to the Synchronization section for details.

Capacitor Selection Considerations

The C_{IN} and C_{OUT} capacitor values in Table 1 are the minimum recommended values for the associated operating conditions. Applying capacitor values below those indicated in Table 1 is not recommended and may result in undesirable operation. Using larger values is generally acceptable, and can yield improved dynamic response, if it is necessary. Again, it is incumbent upon the user to

Table 1. Recommended Component Values and Configuration ($T_A = 25^\circ\text{C}$)

V_{IN}	V_{OUT}	R_{FB}	C_{IN}^2	C_{OUT}	C_{FF}	BIAS	f_{SW}	R_T	MAX f_{SW}	MIN R_T
3.4V to 40V	0.97V	open	2.2 μ F 50V 0805	100 μ F 4V 0805	47pF	3.2-19V	450kHz	100k	660kHz	63.4k
3.4V to 40V	1.2V	1.05M	2.2 μ F 50V 0805	100 μ F 4V 0805	47pF	3.2-19V	550kHz	78.7k	900kHz	45.3k
3.4V to 40V	1.5V	464k	2.2 μ F 50V 0805	100 μ F 4V 0805	27pF	3.2-19V	650kHz	64.9k	1MHz	41.2k
3.4V to 40V	1.8V	294k	2.2 μ F 50V 0805	100 μ F 4V 0805	10pF	3.2-19V	700kHz	60.4k	1.3MHz	28.7k
3.4V to 40V	2V	237k	2.2 μ F 50V 0805	100 μ F 4V 0805		3.2-19V	850kHz	51.5k	1.4MHz	28.0k
3.5V to 40V ¹	2.5V	158k	2.2 μ F 50V 0805	47 μ F 4V 0805		3.2-19V	900kHz	45.3k	1.7MHz	21.5k
4.5V to 40V ¹	3.3V	102k	2.2 μ F 50V 0805	47 μ F 4V 0805		3.2-19V	900kHz	45.3k	2.2MHz	15.8k
6.5V to 40V ¹	5V	60.4k	2.2 μ F 50V 0805	22 μ F 6.3V 0805		3.2-19V	1MHz	41.2k	3MHz	10.7k
10V to 40V ¹	8V	34k	2.2 μ F 50V 0805	22 μ F 10V 1206		3.2-19V	1.3MHz	28.7k	3MHz	10.7k
14.5V to 40V ¹	12V	21.5k	4.7 μ F 50V 0805	10 μ F 16V 0805		3.2-19V	1.3MHz	28.7k	3MHz	10.7k
19.5V to 40V ¹	15V	16.9k	4.7 μ F 50V 0805	10 μ F 16V 0805		3.2-19V	1.5MHz	25.5k	3MHz	10.7k
23V to 40V ¹	18V	14k	4.7 μ F 50V 0805	10 μ F 25V 1206		3.2-19V	1.8MHz	20.5k	3MHz	10.7k
3.4V to 36V ¹	-3.3V	102k	2.2 μ F 50V 0805	47 μ F 4V 0805		LTM8065 GND	900kHz	45.3k	2.2MHz	15.8k
3.4V to 35V ¹	-5V	59k	2.2 μ F 50V 0805	22 μ F 6.3V 0805		LTM8065 GND	1MHz	41.2k	3MHz	10.7k
3.4V to 32V ¹	-8V	34k	2.2 μ F 50V 0805	22 μ F 10V 1206		LTM8065 GND	1.3MHz	28.7k	3MHz	10.7k
3.4V to 28V ¹	-12V	21.5k	4.7 μ F 50V 0805	10 μ F 16V 0805		LTM8065 GND	1.3MHz	28.7k	3MHz	10.7k
3.4V to 25V ¹	-15V	16.9k	4.7 μ F 50V 0805	10 μ F 16V 0805		LTM8065 GND	1.5MHz	25.5k	3MHz	10.7k
3.4V to 22V ¹	-18V	14k	4.7 μ F 50V 0805	10 μ F 25V 1206		LTM8065 GND	1.8MHz	20.5k	3MHz	10.7k

1. The LTM8065 may be capable of lower input voltages but may skip off cycles.
2. An input bulk capacitor is required

APPLICATIONS INFORMATION

verify proper operation over the intended system's line, load and environmental conditions.

Ceramic capacitors are small, robust and have very low ESR. However, not all ceramic capacitors are suitable. X5R and X7R types are stable over temperature and applied voltage and give dependable service. Other types, including Y5V and Z5U have very large temperature and voltage coefficients of capacitance. In an application circuit they may have only a small fraction of their nominal capacitance resulting in much higher output voltage ripple than expected.

Ceramic capacitors are also piezoelectric. In Burst Mode operation, the LTM8065's switching frequency depends on the load current, and can excite a ceramic capacitor at audio frequencies, generating audible noise. Since the LTM8065 operates at a lower current limit during Burst Mode operation, the noise is typically very quiet to a casual ear.

If this audible noise is unacceptable, use a high performance electrolytic capacitor at the output. It may also be a parallel combination of a ceramic capacitor and a low cost electrolytic capacitor.

A final precaution regarding ceramic capacitors concerns the maximum input voltage rating of the LTM8065. A ceramic input capacitor combined with trace or cable inductance forms a high-Q (underdamped) tank circuit. If the LTM8065 circuit is plugged into a live supply, the input voltage can ring to twice its nominal value, possibly exceeding the device's rating. This situation is easily avoided; see the Hot-Plugging Safely section.

Frequency Selection

The LTM8065 uses a constant frequency PWM architecture that can be programmed to switch from 200kHz to 3MHz by using a resistor tied from the RT pin to ground. Table 2 provides a list of R_T resistor values and their resultant frequencies.

Table 2. SW Frequency vs R_T Value

f_{sw} (MHz)	R_T (k Ω)
0.2	232
0.3	150
0.4	110
0.5	88.7
0.6	73.2
0.7	60.4
0.8	52.3
1.0	41.2
1.2	33.2
1.4	28.0
1.6	23.7
1.8	20.5
2.0	18.2
2.2	15.8
3.0	10.7

Operating Frequency Trade-Offs

It is recommended that the user apply the optimal R_T value given in Table 1 for the input and output operating condition. System level or other considerations, however, may necessitate another operating frequency. While the LTM8065 is flexible enough to accommodate a wide range of operating frequencies, a haphazardly chosen one may result in undesirable operation under certain operating or fault conditions. A frequency that is too high can reduce efficiency, generate excessive heat or even damage the LTM8065 if the output is overloaded or short-circuited. A frequency that is too low can result in a final design that has too much output ripple or too large of an output capacitor.

BIAS Pin Considerations

The BIAS pin is used to provide drive power for the internal power switching stage and operate other internal circuitry. For proper operation, it must be powered by at least 3.2V. If the output voltage is programmed to 3.2V or higher, BIAS may be simply tied to V_{OUT} . If V_{OUT} is less than 3.2V, BIAS can be tied to V_{IN} or some other voltage source. If the BIAS pin voltage is too high, the efficiency of the LTM8065 may suffer. The optimum BIAS voltage is dependent upon many factors, such as load current, input voltage, output voltage and switching frequency. In all cases, ensure that the

APPLICATIONS INFORMATION

maximum voltage at the BIAS pin is less than 19V. If BIAS power is applied from a remote or noisy voltage source, it may be necessary to apply a decoupling capacitor locally to the pin. A 1 μ F ceramic capacitor works well. If BIAS is unused, tie this pin to GND.

Maximum Load

The maximum practical continuous load that the LTM8065 can drive, while rated at 2.5A, actually depends upon both the internal current limit and the internal temperature. The internal current limit is designed to prevent damage to the LTM8065 in the case of overload or short-circuit. The internal temperature of the LTM8065 depends upon operating conditions such as the ambient temperature, the power delivered, and the heat sinking capability of the system. For example, if the LTM8065 is configured to regulate at 1.2V, it may continuously deliver 3.5A from 12V_{IN} if the ambient temperature is controlled to less than 55°C. This is quite a bit higher than the 2.5A continuous rating. Please see the “Derating, V_{OUT} = 1.2V” curve in the Typical Performance Characteristics section. Similarly, if the output voltage is 18V and the ambient temperature is 100°C, the LTM8065 will deliver at most 0.15A from 36V_{IN}, which is less than the 2.5A continuous rating.

Load Sharing

The LTM8065 is not designed to load share.

Burst Mode Operation

To enhance efficiency at light loads, the LTM8065 automatically switches to Burst Mode operation which keeps the output capacitor charged to the proper voltage while minimizing the input quiescent current. During Burst Mode operation, the LTM8065 delivers single cycle bursts of current to the output capacitor followed by sleep periods where most of the internal circuitry is powered off and energy is delivered to the load by the output capacitor. During the sleep time, V_{IN} and BIAS quiescent currents are greatly reduced, so, as the load current decreases towards a no load condition, the percentage of time that the LTM8065 operates in sleep mode increases and the average input current is greatly reduced, resulting in higher light load efficiency.

Burst Mode operation is enabled by tying SYNC to GND.

Minimum Input Voltage

The LTM8065 is a step-down converter, so a minimum amount of headroom is required to keep the output in regulation. Keep the input above 3.4V to ensure proper operation. Voltage transients or ripple valleys that cause the input to fall below 3.4V may turn off the LTM8065.

Output Voltage Tracking and Soft-Start

The LTM8065 allows the user to adjust its output voltage ramp rate by means of the TR/SS pin. An internal 2 μ A pulls up the TR/SS pin to about 2.4V. Putting an external capacitor on TR/SS enables soft starting the output to reduce current surges on the input supply. During the soft-start ramp the output voltage will proportionally track the TR/SS pin voltage. For output tracking applications, TR/SS can be externally driven by another voltage source. From 0V to 0.97V, the TR/SS voltage will override the internal 0.97V reference input to the error amplifier, thus regulating the FB pin voltage to that of the TR/SS pin. When TR/SS is above 0.97V, tracking is disabled and the feedback voltage will regulate to the internal reference voltage. The TR/SS pin may be left floating if the function is not needed.

An active pull-down circuit is connected to the TR/SS pin which will discharge the external soft-start capacitor in the case of fault conditions and restart the ramp when the faults are cleared. Fault conditions that clear the soft-start capacitor are the RUN pin transitioning low, V_{IN} voltage falling too low, or thermal shutdown.

Pre-Biased Output

As discussed in the Output Voltage Tracking and Soft-Start section, the LTM8065 regulates the output to the FB voltage determined by the TR/SS pin whenever TR/SS is less than 0.97V. If the LTM8065 output is higher than the target output voltage, the LTM8065 will attempt to regulate the output to the target voltage by returning a small amount of energy back to the input supply. If there is nothing loading the input supply, its voltage may rise. Take care that it does not rise so high that the input voltage exceeds the absolute maximum rating of the LTM8065.

APPLICATIONS INFORMATION

Frequency Foldback

The LTM8065 is equipped with frequency foldback which acts to reduce the thermal and energy stress on the internal power elements during a short circuit or output overload condition. If the LTM8065 detects that the output has fallen out of regulation, the switching frequency is reduced as a function of how far the output is below the target voltage. This in turn limits the amount of energy that can be delivered to the load under fault. During the start-up time, frequency foldback is also active to limit the energy delivered to the potentially large output capacitance of the load. When a clock is applied to the SYNC pin, the SYNC pin is floated or held high, the frequency foldback is disabled, and the switching frequency will slow down only during overcurrent conditions.

Synchronization

To select low ripple Burst Mode operation, tie the SYNC pin below about 0.4V (this can be ground or a logic low output). To synchronize the LTM8065 oscillator to an external frequency, connect a square wave (with about 20% to 80% duty cycle) to the SYNC pin. The square wave amplitude should have valleys that are below 0.4V and peaks above 1.5V.

The LTM8065 will not enter Burst Mode operation at low output loads while synchronized to an external clock, but instead will pulse skip to maintain regulation. The LTM8065 may be synchronized over a 200kHz to 3MHz range. The R_T resistor should be chosen to set the switching frequency equal to or below the lowest synchronization input. For example, if the synchronization signal will be 500kHz and higher, the R_T should be selected for 500kHz.

For some applications it is desirable for the LTM8065 to operate in pulse-skipping mode, offering two major differences from Burst Mode operation. The first is that the clock stays awake at all times and all switching cycles are aligned to the clock. The second is that full switching frequency is reached at lower output load than in Burst Mode operation. These two differences come at the expense of increased quiescent current. To enable pulse-skipping mode, the SYNC pin is floated.

The LTM8065 features spread spectrum operation to further reduce EMI/EMC emissions. To enable spread

spectrum operation, apply between 2.9V and 4.2V to the SYNC pin. In this mode, triangular frequency modulation is used to vary the switching frequency between the value programmed by R_T to about 20% higher than that value. The modulation frequency is about 3kHz. For example, when the LTM8065 is programmed to 2MHz, the frequency will vary from 2MHz to 2.4MHz at a 3kHz rate. When spread spectrum operation is selected, Burst Mode operation is disabled, and the part will run in pulse-skipping mode.

The LTM8065 does not operate in forced continuous mode regardless of SYNC signal.

Negative Output

The LTM8065 is capable of generating a negative output voltage by connecting its V_{OUT} to system GND and the LTM8065 GND to the negative voltage rail. An example of this is shown in the Typical Applications section. The most versatile way to generate a negative output is to use a dedicated regulator that was designed to generate a negative voltage, but using a buck regulator like the LTM8065 to generate a negative voltage is a simple and cost effective solution, as long as certain restrictions are kept in mind.

Figure 1 shows a typical negative output voltage application. Note that LTM8065 V_{OUT} is tied to system GND and input power is applied from V_{IN} to LTM8065 V_{OUT} . As a result, the LTM8065 is not behaving as a true buck regulator, and the maximum output current depends upon the input voltage. In the example shown in the Typical Applications section, there is an attending graph that shows how much current the LTM8065 can deliver for given input voltages.

Note that this configuration requires that any load current transient will directly impress the transient voltage onto

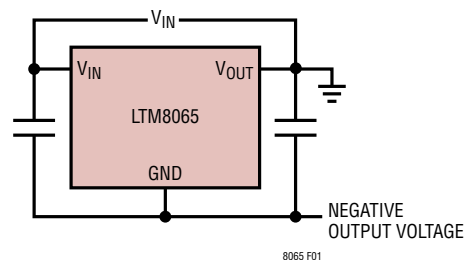

Figure 1. The LTM8065 Can Be Used to Generate a Negative Voltage

APPLICATIONS INFORMATION

the LTM8065 GND, as shown in Figure 2, so fast load transients can disrupt the LTM8065's operation or even cause damage.

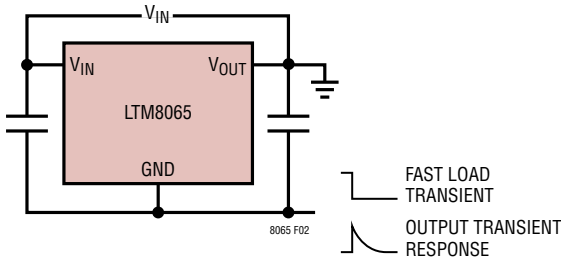

Figure 2. Any Output Voltage Transient Appears on LTM8065 GND

The C_{IN} and C_{OUT} capacitors in Figure 3 form an AC divider at the negative output voltage node. If V_{IN} is hot-plugged or rises quickly, the resultant V_{OUT} will be a positive transient, which may be unhealthy for the application load. An anti-parallel Schottky diode may be able to prevent this positive transient from damaging the load. The location of this Schottky diode is important. For example, in a system where the LTM8065 is far away from the load, placing the Schottky diode closest to the most sensitive load component may be the best design choice. Carefully evaluate whether the negative buck configuration is suitable for the application. For negative outputs, connect BIAS to LTM8065 GND.

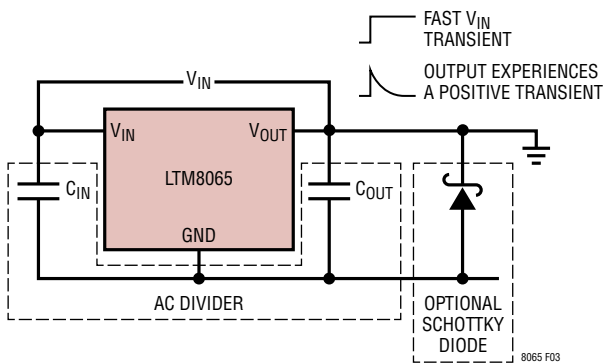

Figure 3. A Schottky Diode Can Limit the Transient Caused by a Fast Rising V_{IN} to Safe Levels

Shorted Input Protection

Care needs to be taken in systems where the output is held high when the input to the LTM8065 is absent. This may

occur in battery charging applications or in battery backup systems where a battery or some other supply is diode ORed with the LTM8065's output. If the V_{IN} pin is allowed to float and the RUN pin is held high (either by a logic signal or because it is tied to V_{IN}), then the LTM8065's internal circuitry pulls its quiescent current through its internal power switch. This is fine if your system can tolerate a few milliamps in this state. If you ground the RUN pin, the internal current drops to essentially zero. However, if the V_{IN} pin is grounded while the output is held high, parasitic diodes inside the LTM8065 can pull large currents from the output through the V_{IN} pin. Figure 4 shows a circuit that runs only when the input voltage is present and that protects against a shorted or reversed input.

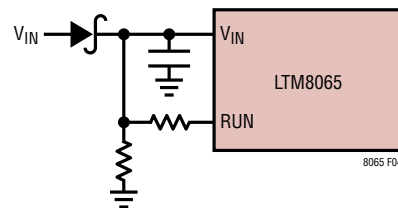

Figure 4. The Input Diode Prevents a Shorted Input from Discharging a Backup Battery Tied to the Output. It Also Protects the Circuit from a Reversed Input. The LTM8065 Runs Only When the Input Is Present

PCB Layout

Most of the headaches associated with PCB layout have been alleviated or even eliminated by the high level of integration of the LTM8065. The LTM8065 is nevertheless a switching power supply, and care must be taken to minimize EMI and ensure proper operation. Even with the high level of integration, you may fail to achieve specified operation with a haphazard or poor layout. See Figure 5 for a suggested layout. Ensure that the grounding and heat sinking are acceptable.

A few rules to keep in mind are:

1. Place C_{FF} , R_{FB} and R_T as close as possible to their respective pins.
2. Place the C_{IN} capacitor as close as possible to the V_{IN} and GND connection of the LTM8065.
3. Place the C_{OUT} capacitor as close as possible to the V_{OUT} and GND connection of the LTM8065.

APPLICATIONS INFORMATION

- Place the C_{IN} and C_{OUT} capacitors such that their ground current flow directly adjacent to or underneath the LTM8065.
- Connect all of the GND connections to as large a copper pour or plane area as possible on the top layer. Avoid breaking the ground connection between the external components and the LTM8065.
- Use vias to connect the GND copper area to the board's internal ground planes. Liberally distribute these GND vias to provide both a good ground connection and thermal path to the internal planes of the printed circuit board. Pay attention to the location and density of the thermal vias in Figure 5. The LTM8065 can benefit from the heat-sinking afforded by vias that connect to internal GND planes at these locations, due to their proximity to internal power handling components. The optimum number of thermal vias depends upon the printed circuit board design. For example, a board might use very small via holes. It should employ more thermal vias than a board that uses larger holes.

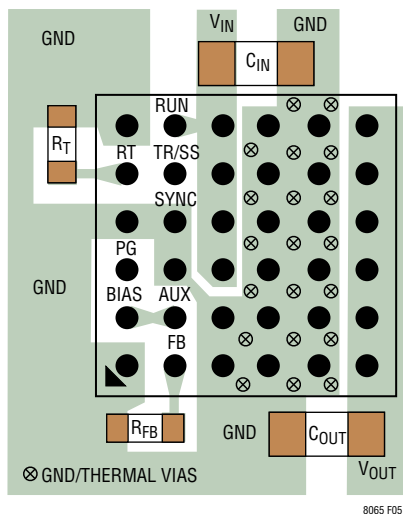

Figure 5. Layout Showing Suggested External Components, GND Plane and Thermal Vias

Hot-Plugging Safely

The small size, robustness and low impedance of ceramic capacitors make them an attractive option for the input bypass capacitor of LTM8065. However, these capacitors can cause problems if the LTM8065 is plugged into a live supply (see Linear Technology Application Note 88 for a complete discussion). The low loss ceramic capacitor combined with stray inductance in series with the power source forms an underdamped tank circuit, and the voltage at the V_{IN} pin of the LTM8065 can ring to more than twice the nominal input voltage, possibly exceeding the LTM8065's rating and damaging the part. If the input supply is poorly controlled or the LTM8065 is hot-plugged into an energized supply, the input network should be designed to prevent this overshoot. This can be accomplished by installing a small resistor in series to V_{IN} , but the most popular method of controlling input voltage overshoot is add an electrolytic bulk cap to the V_{IN} net. This capacitor's relatively high equivalent series resistance damps the circuit and eliminates the voltage overshoot. The extra capacitor improves low frequency ripple filtering and can slightly improve the efficiency of the circuit, though it is likely to be the largest component in the circuit.

Thermal Considerations

The LTM8065 output current may need to be derated if it is required to operate in a high ambient temperature. The amount of current derating is dependent upon the input voltage, output power and ambient temperature. The derating curves given in the Typical Performance Characteristics section can be used as a guide. These curves were generated by the LTM8065 mounted to a 58cm² 4-layer FR4 printed circuit board. Boards of other sizes and layer count can exhibit different thermal behavior, so it is incumbent upon the user to verify proper operation over the intended system's line, load and environmental operating conditions.

APPLICATIONS INFORMATION

For increased accuracy and fidelity to the actual application, many designers use FEA (Finite Element Analysis) to predict thermal performance. To that end, Page 2 of the data sheet typically gives four thermal coefficients:

θ_{JA} – Thermal resistance from junction to ambient

$\theta_{JCbottom}$ – Thermal resistance from junction to the bottom of the product case

θ_{JCTop} – Thermal resistance from junction to top of the product case

θ_{JB} – Thermal resistance from junction to the printed circuit board.

While the meaning of each of these coefficients may seem to be intuitive, JEDEC has defined each to avoid confusion and inconsistency. These definitions are given in JESD 51-12, and are quoted or paraphrased below:

θ_{JA} is the natural convection junction-to-ambient air thermal resistance measured in a one cubic foot sealed enclosure. This environment is sometimes referred to as “still air” although natural convection causes the air to move. This value is determined with the part mounted to a JESD 51-9 defined test board, which does not reflect an actual application or viable operating condition.

$\theta_{JCbottom}$ is the junction-to-board thermal resistance with all of the component power dissipation flowing through the bottom of the package. In the typical μ Module regulator, the bulk of the heat flows out the bottom of the package, but there is always heat flow out into the ambient environment. As a result, this thermal resistance value may be useful for comparing packages but the test conditions don't generally match the user's application.

θ_{JCTop} is determined with nearly all of the component power dissipation flowing through the top of the package. As the electrical connections of the typical μ Module regulator are on the bottom of the package, it is rare for an application

to operate such that most of the heat flows from the junction to the top of the part. As in the case of $\theta_{JCbottom}$, this value may be useful for comparing packages but the test conditions don't generally match the user's application.

θ_{JB} is the junction-to-board thermal resistance where almost all of the heat flows through the bottom of the μ Module regulator and into the board, and is really the sum of the $\theta_{JCbottom}$ and the thermal resistance of the bottom of the part through the solder joints and through a portion of the board. The board temperature is measured a specified distance from the package, using a two sided, two layer board. This board is described in JESD 51-9.

Given these definitions, it should now be apparent that none of these thermal coefficients reflects an actual physical operating condition of a μ Module regulator. Thus, none of them can be individually used to accurately predict the thermal performance of the product. Likewise, it would be inappropriate to attempt to use any one coefficient to correlate to the junction temperature vs load graphs given in the product's data sheet. The only appropriate way to use the coefficients is when running a detailed thermal analysis, such as FEA, which considers all of the thermal resistances simultaneously.

A simplified graphical representation of these thermal resistances is given in Figure 6. The blue resistances are contained within the μ Module regulator, and the green are outside.

The die temperature of the LTM8065 must be lower than the maximum rating, so care should be taken in the layout of the circuit to ensure good heat sinking of the LTM8065. The bulk of the heat flow out of the LTM8065 is through the bottom of the package and the pads into the printed circuit board. Consequently a poor printed circuit board design can cause excessive heating, resulting in impaired performance or reliability. Please refer to the PCB Layout section for printed circuit board design suggestions.

APPLICATIONS INFORMATION

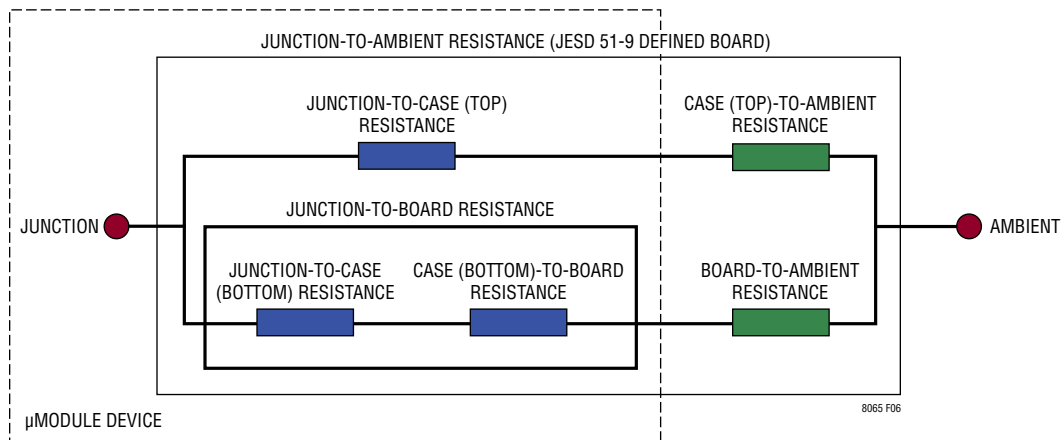
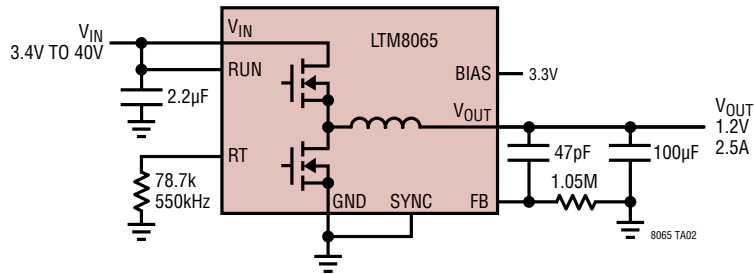

Figure 6. Simplified Graphical Representation of the Thermal Resistance Between the Device Junction and Ambient

TYPICAL APPLICATIONS

1.2V_{OUT} from 3.4V_{IN} to 40V_{IN} Step-Down Converter. BIAS Is Tied to an External 3.3V Source



PINS NOT USED IN THIS CIRCUIT: TR/SS, PG

2.5V_{OUT} from 5.5V_{IN} to 15V_{IN} Step-Down Converter. BIAS Is Tied to V_{IN}

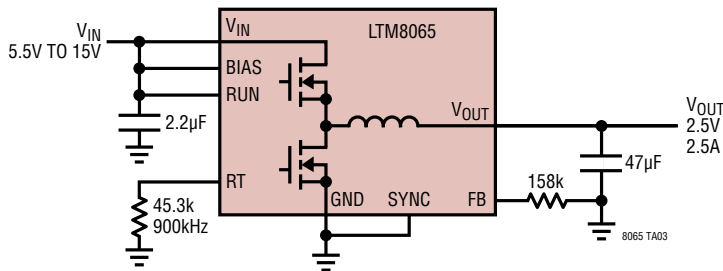

PINS NOT USED IN THIS CIRCUIT: TR/SS, PG

-5V_{OUT} from 3.4V_{IN} to 35V_{IN} Positive to Negative Converter

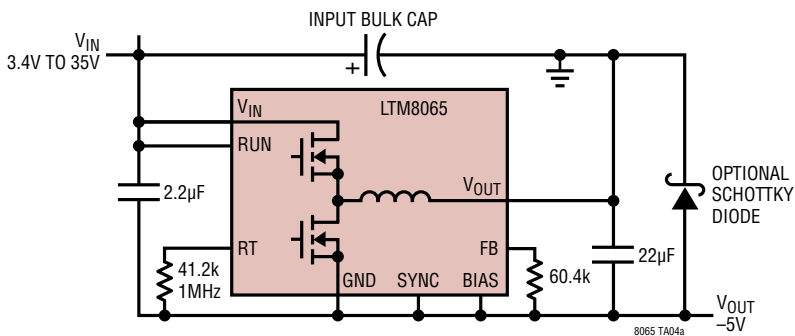

PINS NOT USED IN THIS CIRCUIT:
TR/SS, PG, AUX

INPUT BULK CAP: PLACE THE INPUT BULK CAP BETWEEN V_{IN} AND V_{OUT} (SYSTEM GROUND) TO MITIGATE THE OUTPUT POSITIVE TRANSIENT WHEN V_{IN} RISES QUICKLY.

Maximum Load Current vs V_{IN},
BIAS tied to LTM8065 GND

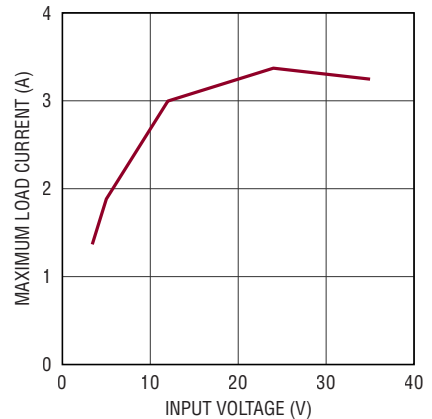

8065 TA04b

PACKAGE PHOTO

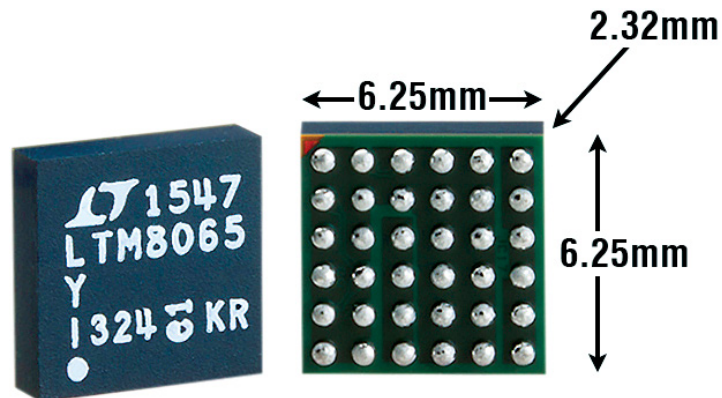

PACKAGE DESCRIPTION

Table 3. LTM8065 Pinout (Sorted by Pin Number)

PIN	PIN NAME	PIN	PIN NAME	PIN	PIN NAME	PIN	PIN NAME	PIN	PIN NAME	PIN	PIN NAME	PIN	PIN NAME
A 1	GND	B 1	FB	C 1	GND	D 1	GND	E 1	GND	F 1	V _{OUT}		
A 2	BIAS	B 2	AUX	C 2	GND	D 2	GND	E 2	GND	F 2	V _{OUT}		
A 3	PG	B 3	GND	C 3	V _{IN}	D 3	GND	E 3	GND	F 3	V _{OUT}		
A 4	GND	B 4	SYNC	C 4	V _{IN}	D 4	GND	E 4	GND	F 4	V _{OUT}		
A 5	RT	B 5	TR/SS	C 5	V _{IN}	D 5	GND	E 5	GND	F 5	V _{OUT}		
A 6	GND	B 6	RUN	C 6	V _{IN}	D 6	GND	E 6	GND	F 6	V _{OUT}		

PACKAGE DESCRIPTION

BGA Package
36-Lead (6.25mm × 6.25mm × 2.32mm)
 (Reference LTC DWG # 05-08-1998 Rev A)

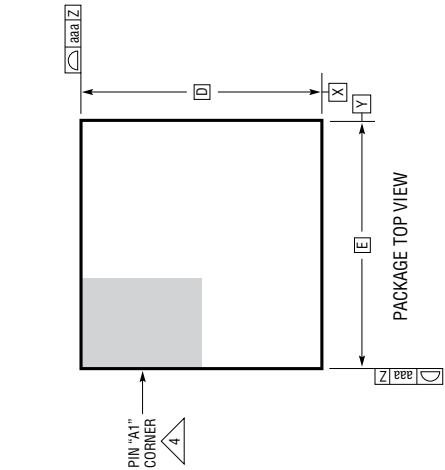
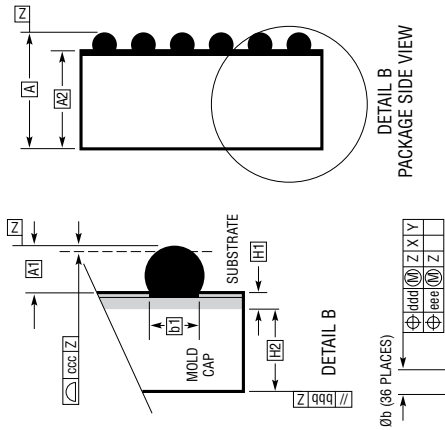
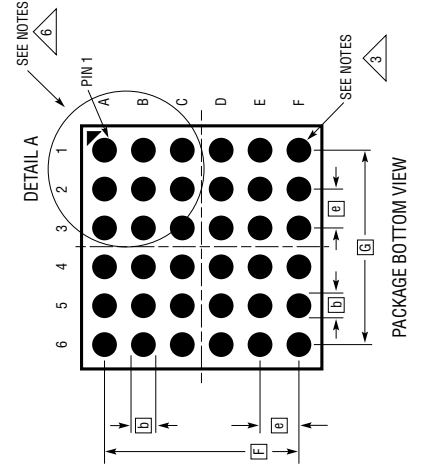

- NOTES:**
1. DIMENSIONING AND TOLERANCING PER ASME Y14.5M-1994
 2. ALL DIMENSIONS ARE IN MILLIMETERS
 3. BALL DESIGNATION PER JEP95
 4. DETAILS OF PIN #1 IDENTIFIER ARE OPTIONAL BUT MUST BE LOCATED WITHIN THE ZONE INDICATED. THE PIN #1 IDENTIFIER MAY BE EITHER A MOLD OR MARKED FEATURE
 5. PRIMARY DATUM - Z - IS SEATING PLANE
 6. PACKAGE ROW AND COLUMN LABELING MAY VARY AMONG μ Module PRODUCTS. REVIEW EACH PACKAGE LAYOUT CAREFULLY

DIMENSIONS				
SYMBOL	MIN	NOM	MAX	NOTES
A	2.12	2.32	2.52	
A1	0.40	0.50	0.60	BALL HT
A2	1.72	1.82	1.92	
b	0.50	0.60	0.70	BALL DIMENSION
b1	0.47	0.50	0.53	PAD DIMENSION
D	6.25			
E	6.25			
e	1.00			
F	5.00			
G	5.00			
H1	0.27	0.32	0.37	SUBSTRATE THK
H2	1.45	1.50	1.55	MOLD CAP HT
aaa	0.15			
bbb	0.10			
ccc	0.20			
ddd	0.25			
eee	0.10			
TOTAL NUMBER OF BALLS: 36				

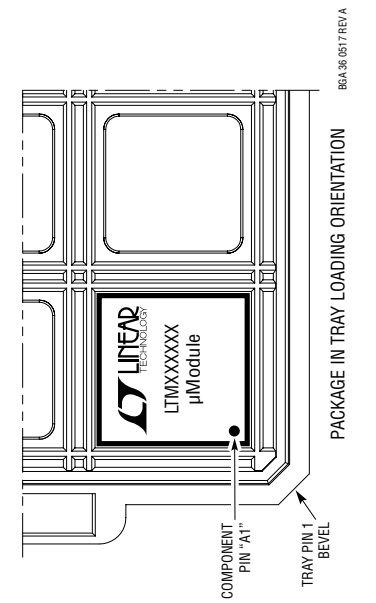
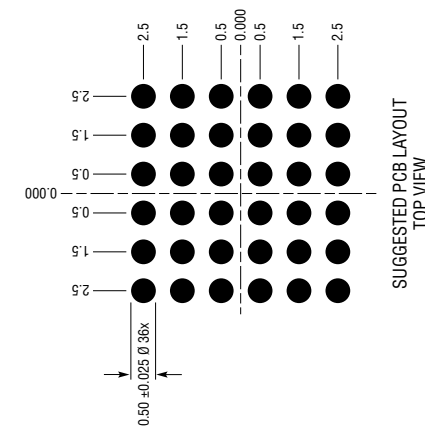

REVISION HISTORY

REV	DATE	DESCRIPTION	PAGE NUMBER
A	01/18	Added note on Positive to Negative Converter Application Circuit	22
B	09/18	Updated package thermal resistance $\theta_{JA} = 20^{\circ}\text{C/W}$ to 21°C/W , $\theta_{JCbottom} = 5.3^{\circ}\text{C/W}$ to 5.9°C/W $\theta_{JCtop} = 24.5^{\circ}\text{C/W}$ to 36.5°C/W , $\theta_{JB} = 5.0^{\circ}\text{C/W}$ to 6.3°C/W Added clarification of BIAS Pin: If unused, tie BIAS Pin to GND Updated BIAS Pin condition = 5V to (3.2V to 19V) (Table 1)	2 11,13,16 14

TYPICAL APPLICATION

0.97V_{OUT} from 3.4V_{IN} to 40V_{IN} Step Down Converter with Spread Spectrum. BIAS is Tied to an External 3.3V Source

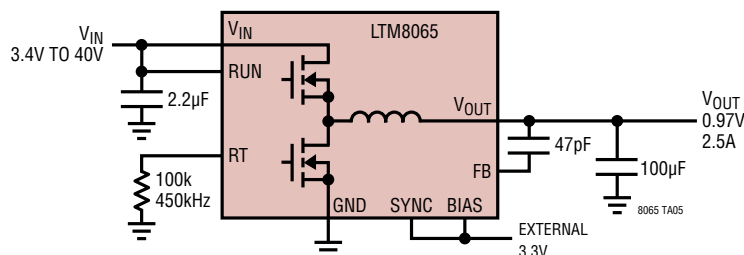

PINS NOT USED IN THIS CIRCUIT: TR/SS, PG, AUX

DESIGN RESOURCES

SUBJECT	DESCRIPTION
µModule Design and Manufacturing Resources	<p>Design:</p> <ul style="list-style-type: none"> • Selector Guides • Demo Boards and Gerber Files • Free Simulation Tools <p>Manufacturing:</p> <ul style="list-style-type: none"> • Quick Start Guide • PCB Design, Assembly and Manufacturing Guidelines • Package and Board Level Reliability
µModule Regulator Products Search	<ol style="list-style-type: none"> 1. Sort table of products by parameters and download the result as a spread sheet. 2. Search using the Quick Power Search parametric table. <div style="border: 1px solid #ccc; padding: 5px; margin: 5px 0;"> <p>Quick Power Search</p> <p>Input V_{in} (Min) <input type="text"/> V V_{in} (Max) <input type="text"/> V</p> <p>Output V_{out} <input type="text"/> V I_{out} <input type="text"/> A</p> <p style="text-align: right;"><input type="button" value="Search"/></p> </div>
TechClip Videos	Quick videos detailing how to bench test electrical and thermal performance of µModule products.
Digital Power System Management	Linear Technology's family of digital power supply management ICs are highly integrated solutions that offer essential functions, including power supply monitoring, supervision, margining and sequencing, and feature EEPROM for storing user configurations and fault logging.

RELATED PARTS

PART NUMBER	DESCRIPTION	COMMENTS
LTM8053	40V, 3.5A Step-Down µModule Regulator	$3.4V \leq V_{IN} \leq 40V$. $0.97V \leq V_{OUT} \leq 15V$. 6.25mm x 9mm x 3.32mm BGA Package.
LTM8032	36V, 2A Low EMI Step-Down µModule Regulator	$3.6V \leq V_{IN} \leq 36V$, $0.8V \leq V_{OUT} \leq 10V$. EN55022B Compliant.
LTM8033	36V, 3A Low EMI Step-Down µModule Regulator	$3.6V \leq V_{IN} \leq 36V$. $0.8V \leq V_{OUT} \leq 24V$. EN55022B Compliant.
LTM8026	36V, 5A CVCC Step-Down µModule Regulator	$6V \leq V_{IN} \leq 36V$. $1.2V \leq V_{OUT} \leq 24V$. Constant Voltage Constant Current Operation.
LTM4613	36V, 8A Low EMI Step-Down µModule Regulator	$5V \leq V_{IN} \leq 36V$. $3.3V \leq V_{OUT} \leq 15V$. EN55022B Compliant.
LTM8027	60V, 4A Step-Down µModule Regulator	$4.5V \leq V_{IN} \leq 60V$, $2.5V \leq V_{OUT} \leq 24V$.
LTM8050	58V, 2A Step-Down µModule Regulator	$3.6V \leq V_{IN} \leq 58V$, $0.8V \leq V_{OUT} \leq 24V$.
LTM8003	3.5A Version of LTM8002, 40V, 3.5A, $I_Q = 25\mu A$ FMEA Compliant	$3.4V \leq V_{IN} \leq 40V$, $0.97V \leq V_{OUT} \leq 18V$, 6.25mm x 9mm x 3.32 BGA Package.
LTM8002	FMEA Compliant Pinout, 40A, 2.5A Step-Down µModule Regulator	$3.4V \leq V_{IN} \leq 40V$, $0.97V \leq V_{OUT} \leq 18V$, 6.25mm x 6.25mm x 2.32mm BGA Package.

Компания «Океан Электроники» предлагает заключение долгосрочных отношений при поставках импортных электронных компонентов на взаимовыгодных условиях!

Наши преимущества:

- Поставка оригинальных импортных электронных компонентов напрямую с производств Америки, Европы и Азии, а так же с крупнейших складов мира;
- Широкая линейка поставок активных и пассивных импортных электронных компонентов (более 30 млн. наименований);
- Поставка сложных, дефицитных, либо снятых с производства позиций;
- Оперативные сроки поставки под заказ (от 5 рабочих дней);
- Экспресс доставка в любую точку России;
- Помощь Конструкторского Отдела и консультации квалифицированных инженеров;
- Техническая поддержка проекта, помощь в подборе аналогов, поставка прототипов;
- Поставка электронных компонентов под контролем ВП;
- Система менеджмента качества сертифицирована по Международному стандарту ISO 9001;
- При необходимости вся продукция военного и аэрокосмического назначения проходит испытания и сертификацию в лаборатории (по согласованию с заказчиком);
- Поставка специализированных компонентов военного и аэрокосмического уровня качества (Xilinx, Altera, Analog Devices, Intersil, Interpoint, Microsemi, Actel, Aeroflex, Peregrine, VPT, Syfer, Eurofarad, Texas Instruments, MS Kennedy, Miteq, Cobham, E2V, MA-COM, Hittite, Mini-Circuits, General Dynamics и др.);

Компания «Океан Электроники» является официальным дистрибьютором и эксклюзивным представителем в России одного из крупнейших производителей разъемов военного и аэрокосмического назначения «JONHON», а так же официальным дистрибьютором и эксклюзивным представителем в России производителя высокотехнологичных и надежных решений для передачи СВЧ сигналов «FORSTAR».



JONHON

«JONHON» (основан в 1970 г.)

Разъемы специального, военного и аэрокосмического назначения:

(Применяются в военной, авиационной, аэрокосмической, морской, железнодорожной, горно- и нефтедобывающей отраслях промышленности)

«FORSTAR» (основан в 1998 г.)

ВЧ соединители, коаксиальные кабели, кабельные сборки и микроволновые компоненты:

(Применяются в телекоммуникациях гражданского и специального назначения, в средствах связи, РЛС, а так же военной, авиационной и аэрокосмической отраслях промышленности).



Телефон: 8 (812) 309-75-97 (многоканальный)

Факс: 8 (812) 320-03-32

Электронная почта: ocean@oceanchips.ru

Web: <http://oceanchips.ru/>

Адрес: 198099, г. Санкт-Петербург, ул. Калинина, д. 2, корп. 4, лит. А