

Analog Devices Welcomes Hittite Microwave Corporation

NO CONTENT ON THE ATTACHED DOCUMENT HAS CHANGED



THIS PAGE INTENTIONALLY LEFT BLANK

GaAs MMIC SUB-HARMONICALLY PUMPED MIXER, 20 - 32 GHz

Typical Applications

The HMC264 is ideal for:

- Microwave Point-to-Point Radios
- LMDS
- SATCOM

Features

- Integrated LO Amplifier: -4 dBm Input
- Sub-Harmonically Pumped (x2) LO
- High 2LO/RF Isolation: 40 dB
- Small Size: 1.32 x 0.97 x 0.1 mm

Functional Diagram

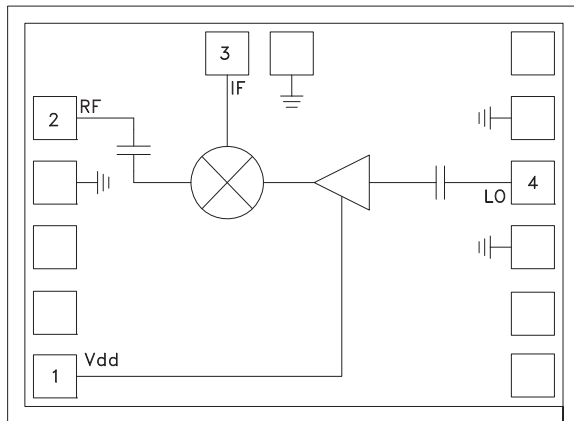

General Description

The HMC264 chip is a sub-harmonically pumped (x2) MMIC mixer with an integrated LO amplifier which can be used as an upconverter or downconverter. The chip utilizes a GaAs PHEMT technology that results in a small overall chip area of 1.28mm². The 2LO to RF isolation is excellent eliminating the need for additional filtering. The LO amplifier is a single bias (+3V to +4V) two stage design with only -4 dBm nominal drive requirement. All data is measured with the chip in a 50 ohm test fixture connected via 0.025 mm (1 mil) diameter wire bonds of minimal length <0.31 mm (<12 mils).

Electrical Specifications, $T_A = +25^\circ \text{C}$, As a Function of LO Drive & Vdd

Parameter	IF = 1 GHz LO = 0 dBm & Vdd = +4V			IF = 1 GHz LO = -4 dBm & Vdd = +4V			IF = 1 GHz LO = -4 dBm & Vdd = +3V			Units
	Min.	Typ.	Max.	Min.	Typ.	Max.	Min.	Typ.	Max.	
Frequency Range, RF	24 - 32			20 - 30			22 - 29			GHz
Frequency Range, LO	12 - 16			10 - 15			10.5 - 14.5			GHz
Frequency Range, IF	DC - 6			DC - 6			DC - 4			GHz
Conversion Loss		10	13		10	12		9	11	dB
Noise Figure (SSB)		10	13		10	12		9	11	dB
2LO to RF Isolation	29	35		29	40		18	22 - 30		dB
2LO to IF Isolation	32	40		29	40 ~ 50		25	30		dB
IP3 (Input)	5	13		5	13		3	10		dBm
1 dB Gain Compression (Input)	+3	+6		-3	0 ~ +4		-5	0 ~ +3		dBm
Supply Current (Idd)		28	50		28	50		25	50	mA

GaAs MMIC SUB-HARMONICALLY PUMPED MIXER, 20 - 32 GHz

Conversion Gain vs. Temperature @ LO = -4 dBm, Vdd = +4V

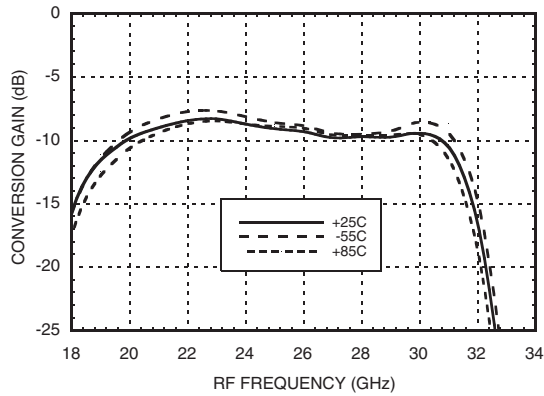

Conversion Gain vs. Temperature @ LO = -4 dBm, Vdd = +3V

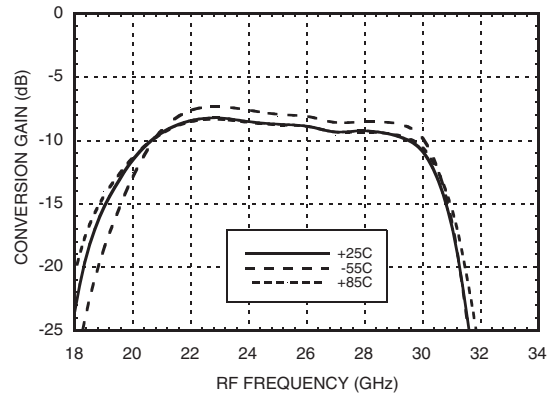

Conversion Gain vs. LO Drive @ Vdd = +4V

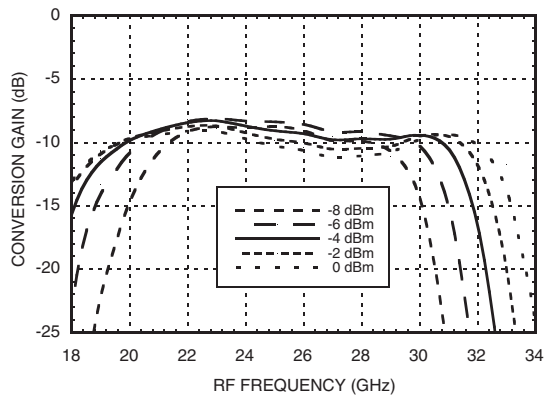

Conversion Gain vs. LO Drive @ Vdd = +3V

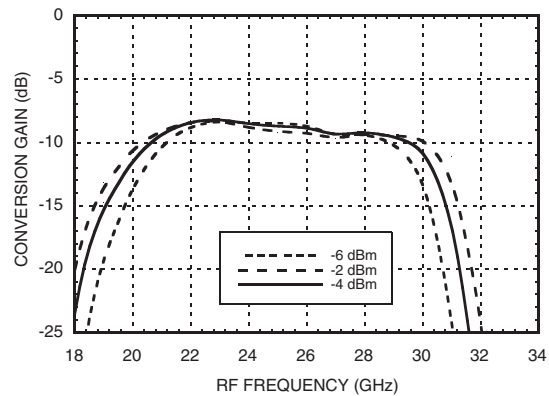

Isolation @ LO = -4 dBm, Vdd = +4V

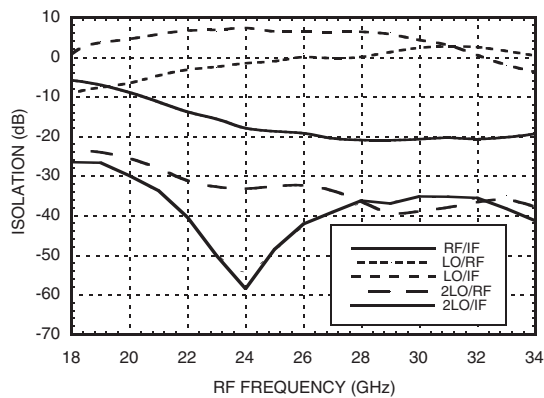

Isolation @ LO = -4 dBm, Vdd = +3V

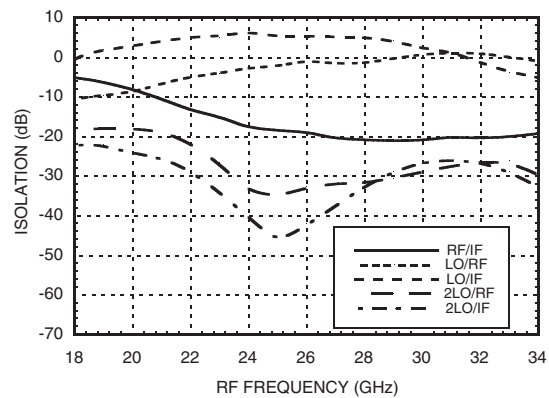

GaAs MMIC SUB-HARMONICALLY PUMPED MIXER, 20 - 32 GHz

Input IP3 vs. LO Drive @ Vdd = +4V

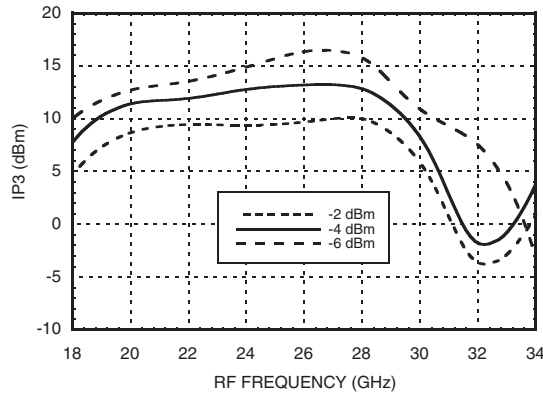

Input IP3 vs. LO Drive @ Vdd = +3V

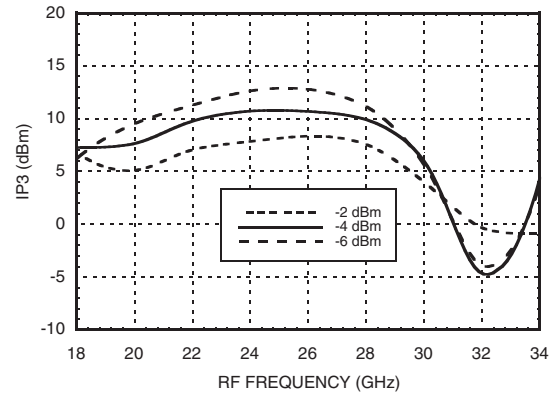

Input IP3 vs. Temperature @ LO = -4 dBm, Vdd = +4V

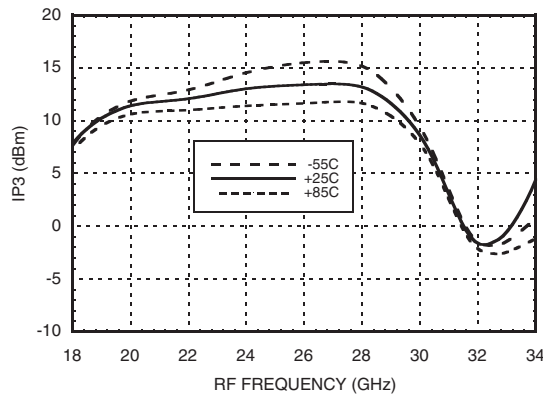

Input IP3 vs. Temperature @ LO = -4 dBm, Vdd = +3V

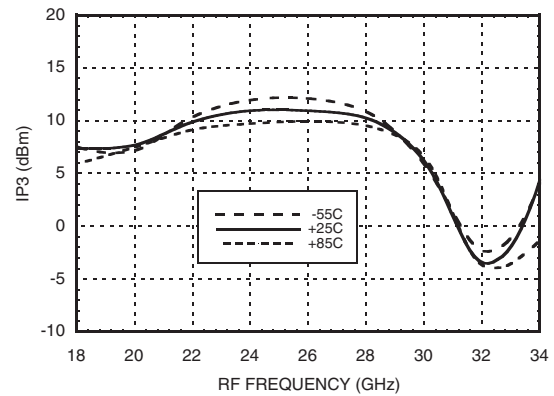

Input IP2 vs. LO Drive @ Vdd = +4V

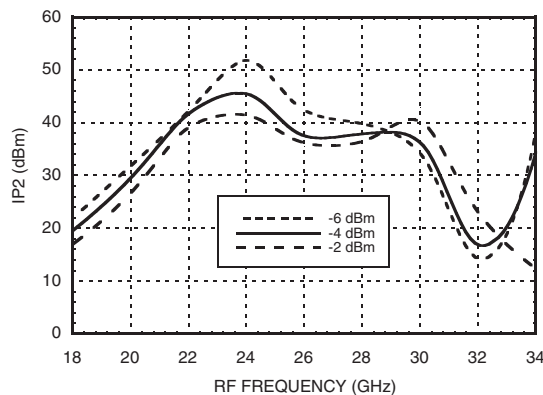

Input IP2 vs. LO Drive @ Vdd = +3V

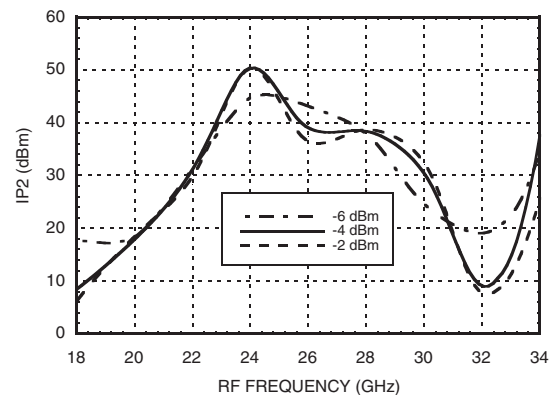

GaAs MMIC SUB-HARMONICALLY PUMPED MIXER, 20 - 32 GHz

Input IP2 vs. Temperature @ LO = -4 dBm, Vdd = +4V

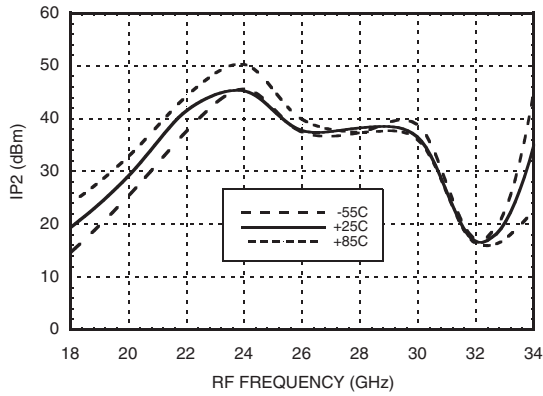

Input IP2 vs. Temperature @ LO = -4 dBm, Vdd = +3V

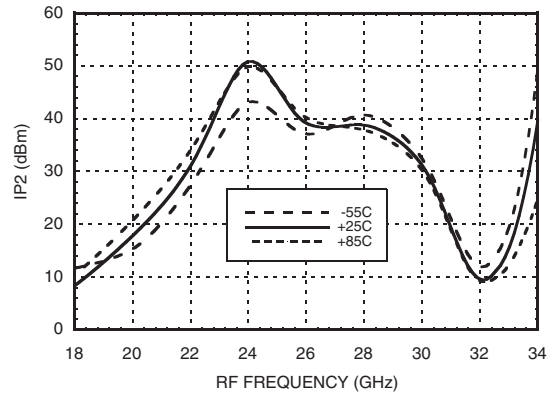

Input P1dB vs. Temperature @ LO = -4 dBm, Vdd = +4V

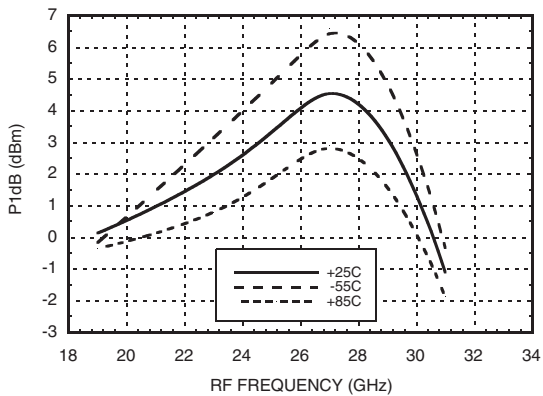

Input P1dB vs. Temperature @ LO = -4 dBm, Vdd = +3V

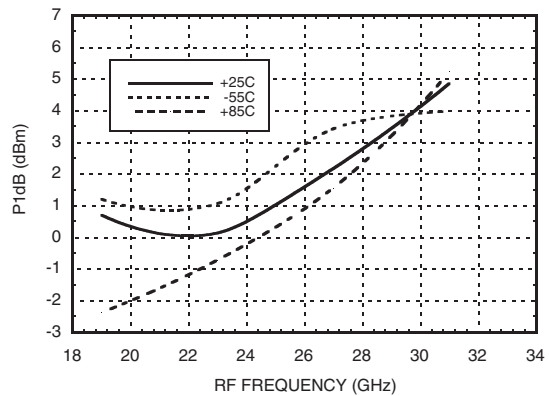

GaAs MMIC SUB-HARMONICALLY PUMPED MIXER, 20 - 32 GHz

Upconverter Performance
Conversion Gain, LO = -4 dBm

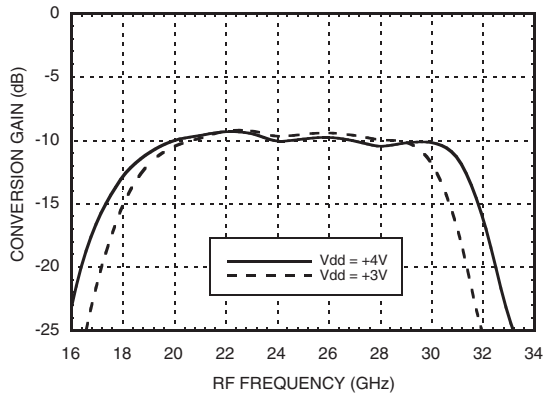

Return Loss @ LO = -4 dBm, Vdd = +4V

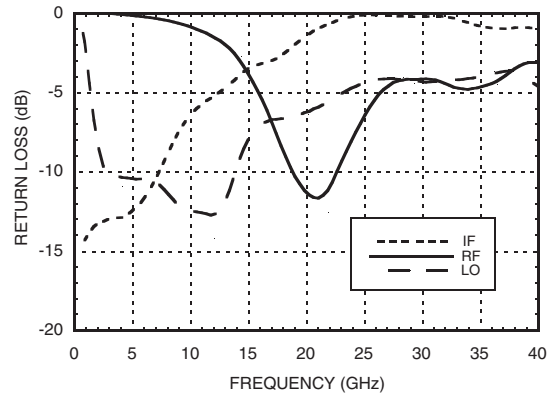

IF Bandwidth @ LO = -4 dBm, Vdd = +4V

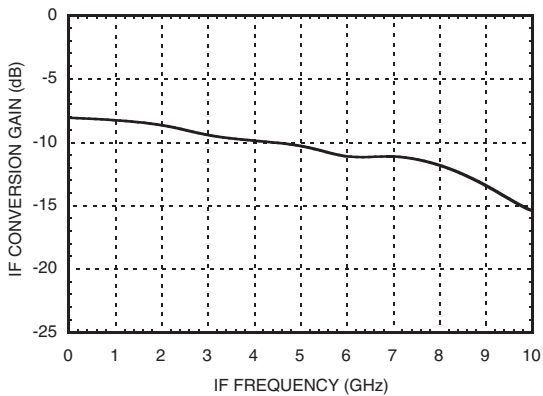

MxN Spurious Outputs
@ LO Drive = -4 dBm, Vdd = +4V

mRF	nLO					
	±5	±4	±3	±2	±1	0
-3						
-2	-36					
-1	-54	-22	-34			
0				-15	+26	
1				x	-30	-10
2		-54	-38	-66		
3	-74	-67				

RF = 30 GHz @ -10 dBm
LO = 13.5 GHz @ -4 dBm
All values in dBc below the IF power level

**GaAs MMIC SUB-HARMONICALLY
PUMPED MIXER, 20 - 32 GHz**

Absolute Maximum Ratings

RF / IF Input (Vdd = +4V)	+13 dBm
LO Drive (Vdd = +4V)	+13 dBm
Vdd	+5.5 Vdc
Storage Temperature	-65 to +150 °C
Operating Temperature	-55 to +85 °C



**ELECTROSTATIC SENSITIVE DEVICE
OBSERVE HANDLING PRECAUTIONS**

Pad Descriptions

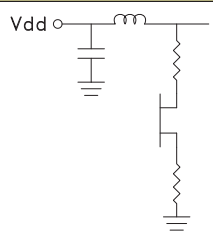
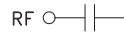
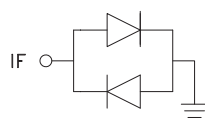
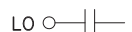
Pad Number	Function	Description	Interface Schematic
1	Vdd	Power supply for the LO Amplifier. An external RF bypass capacitor of 100 - 330 pF is required. A MIM border capacitor is recommended. The bond length to the capacitor should be as short as possible. The ground side of the capacitor should be connected to the housing ground.	
2	RF	This pad is AC coupled and matched to 50 Ohm.	
3	IF	This pad is DC coupled and should be DC blocked externally using a series capacitor whose value has been chosen to pass the necessary IF frequency range. Any applied DC voltage to this pin will result in die non-function and possible die failure.	
4	LO	This pad is AC coupled and matched to 50 Ohm.	

**GaAs MMIC SUB-HARMONICALLY
PUMPED MIXER, 20 - 32 GHz**

Outline Drawing

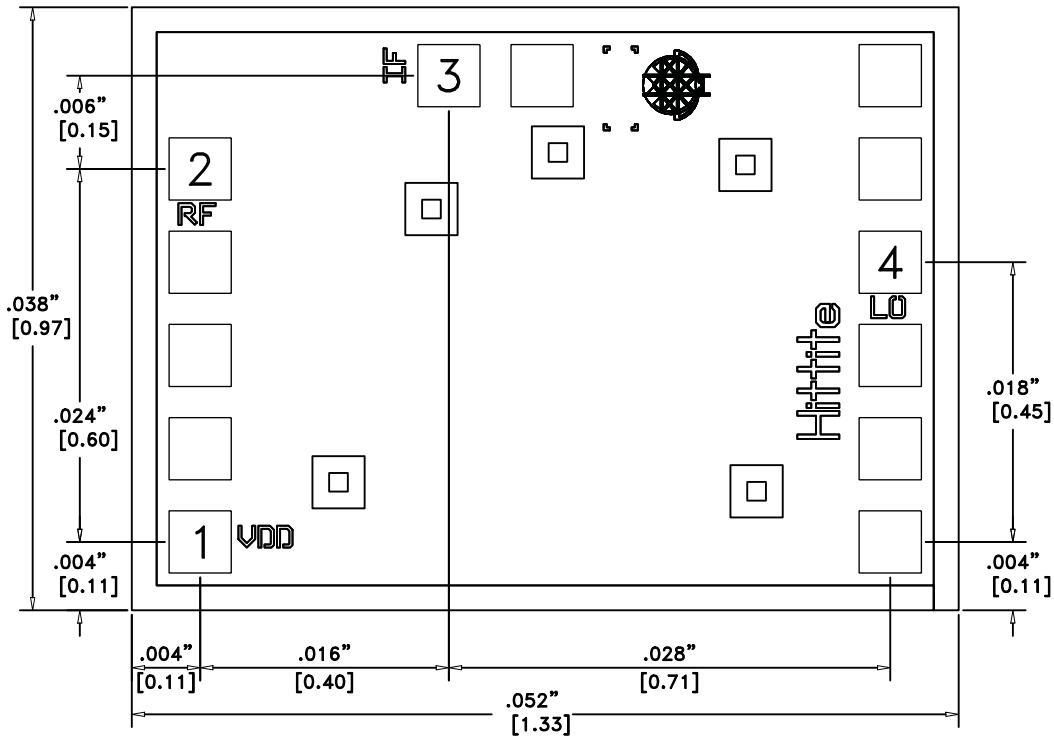

Die Packaging Information ^[1]

Standard	Alternate
GP-2 (Gel Pack)	[2]

[1] Refer to the "Packaging Information" section for die packaging dimensions.

[2] For alternate packaging information contact Hittite Microwave Corporation.

NOTES:

1. ALL DIMENSIONS ARE IN INCHES [MM].
2. DIE THICKNESS IS .004".
3. TYPICAL BOND PAD IS .004" SQUARE.
4. BOND PAD SPACING CENTER TO CENTER IS .006".
5. BACKSIDE METALLIZATION: GOLD.
6. BOND PAD METALLIZATION: GOLD.
7. BACKSIDE METAL IS GROUND.
8. CONNECTION NOT REQUIRED FOR UNLABELED BOND PADS.

**GaAs MMIC SUB-HARMONICALLY
PUMPED MIXER, 20 - 32 GHz**

Mounting & Bonding Techniques for Millimeterwave GaAs MMICs

The die should be attached directly to the ground plane eutectically or with conductive epoxy (see HMC general Handling, Mounting, Bonding Note).

50 Ohm Microstrip transmission lines on 0.127mm (5 mil) thick alumina thin film substrates are recommended for bringing RF to and from the chip (Figure 1). If 0.254mm (10 mil) thick alumina thin film substrates must be used, the die should be raised 0.150mm (6 mils) so that the surface of the die is coplanar with the surface of the substrate. One way to accomplish this is to attach the 0.102mm (4 mil) thick die to a 0.150mm (6 mil) thick molybdenum heat spreader (moly-tab) which is then attached to the ground plane (Figure 2).

Microstrip substrates should be brought as close to the die as possible in order to minimize bond wire length. Typical die-to-substrate spacing is 0.076mm (3 mils).

An RF bypass capacitor should be used on the Vdd input. A 100 pF single layer capacitor (mounted eutectically or by conductive epoxy) placed no further than 0.762mm (30 Mils) from the chip is recommended. The photo in figure 3 shows a typical assembly for the HMC264 MMIC chip.

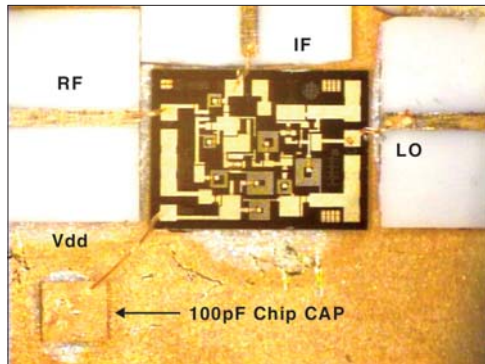
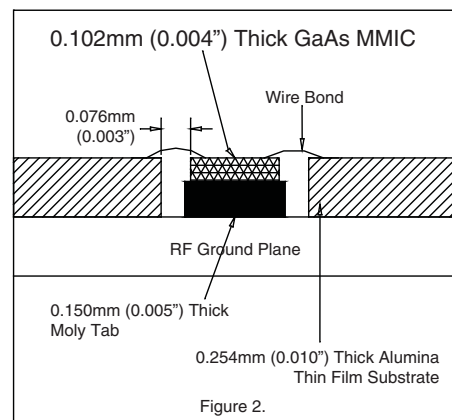
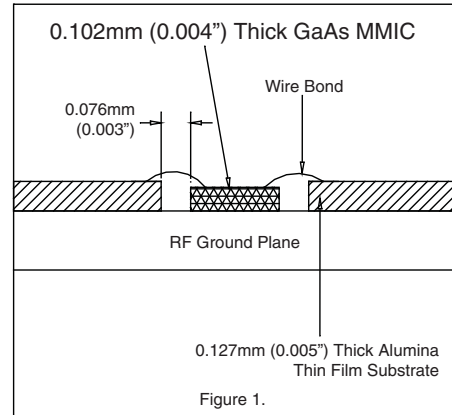

Figure 3: Typical HMC264 Assembly



Handling Precautions

Follow these precautions to avoid permanent damage.

Storage: All bare die are placed in either Waffle or Gel based ESD protective containers, and then sealed in an ESD protective bag for shipment. Once the sealed ESD protective bag has been opened, all die should be stored in a dry nitrogen environment.

Cleanliness: Handle the chips in a clean environment. DO NOT attempt to clean the chip using liquid cleaning systems.

Static Sensitivity: Follow ESD precautions to protect against ESD strikes.

Transients: Suppress instrument and bias supply transients while bias is applied. Use shielded signal and bias cables to minimize inductive pick-up.

General Handling: Handle the chip along the edges with a vacuum collet or with a sharp pair of bent tweezers. The surface of the chip has fragile air bridges and should not be touched with vacuum collet, tweezers, or fingers.

Mounting

The chip is back-metallized and can be die mounted with AuSn eutectic preforms or with electrically conductive epoxy. The mounting surface should be clean and flat.

Eutectic Die Attach: A 80/20 gold tin preform is recommended with a work surface temperature of 255 °C and a tool temperature of 265 °C. When hot 90/10 nitrogen/hydrogen gas is applied, tool tip temperature should be 290 °C. DO NOT expose the chip to a temperature greater than 320 °C for more than 20 seconds. No more than 3 seconds of scrubbing should be required for attachment.

Epoxy Die Attach: Apply a minimum amount of epoxy to the mounting surface so that a thin epoxy fillet is observed around the perimeter of the chip once it is placed into position. Cure epoxy per the manufacturer's schedule.

Wire Bonding

Ball or wedge bond with 0.025 mm (1 mil) diameter pure gold wire. Thermosonic wirebonding with a nominal stage temperature of 150 °C and a ball bonding force of 40 to 50 grams or wedge bonding force of 18 to 22 grams is recommended. Use the minimum level of ultrasonic energy to achieve reliable wirebonds. Wirebonds should be started on the chip and terminated on the package or substrate. All bonds should be as short as possible <0.31 mm (12 mils).

For price, delivery, and to place orders, please contact Hittite Microwave Corporation:
20 Alpha Road, Chelmsford, MA 01824 Phone: 978-250-3343 Fax: 978-250-3373
Order On-line at www.hittite.com

Компания «Океан Электроники» предлагает заключение долгосрочных отношений при поставках импортных электронных компонентов на взаимовыгодных условиях!

Наши преимущества:

- Поставка оригинальных импортных электронных компонентов напрямую с производств Америки, Европы и Азии, а так же с крупнейших складов мира;
- Широкая линейка поставок активных и пассивных импортных электронных компонентов (более 30 млн. наименований);
- Поставка сложных, дефицитных, либо снятых с производства позиций;
- Оперативные сроки поставки под заказ (от 5 рабочих дней);
- Экспресс доставка в любую точку России;
- Помощь Конструкторского Отдела и консультации квалифицированных инженеров;
- Техническая поддержка проекта, помощь в подборе аналогов, поставка прототипов;
- Поставка электронных компонентов под контролем ВП;
- Система менеджмента качества сертифицирована по Международному стандарту ISO 9001;
- При необходимости вся продукция военного и аэрокосмического назначения проходит испытания и сертификацию в лаборатории (по согласованию с заказчиком);
- Поставка специализированных компонентов военного и аэрокосмического уровня качества (Xilinx, Altera, Analog Devices, Intersil, Interpoint, Microsemi, Actel, Aeroflex, Peregrine, VPT, Syfer, Eurofarad, Texas Instruments, MS Kennedy, Miteq, Cobham, E2V, MA-COM, Hittite, Mini-Circuits, General Dynamics и др.);

Компания «Океан Электроники» является официальным дистрибьютором и эксклюзивным представителем в России одного из крупнейших производителей разъемов военного и аэрокосмического назначения «JONHON», а так же официальным дистрибьютором и эксклюзивным представителем в России производителя высокотехнологичных и надежных решений для передачи СВЧ сигналов «FORSTAR».



JONHON

«JONHON» (основан в 1970 г.)

Разъемы специального, военного и аэрокосмического назначения:

(Применяются в военной, авиационной, аэрокосмической, морской, железнодорожной, горно- и нефтедобывающей отраслях промышленности)

«FORSTAR» (основан в 1998 г.)

ВЧ соединители, коаксиальные кабели, кабельные сборки и микроволновые компоненты:

(Применяются в телекоммуникациях гражданского и специального назначения, в средствах связи, РЛС, а так же военной, авиационной и аэрокосмической отраслях промышленности).



Телефон: 8 (812) 309-75-97 (многоканальный)

Факс: 8 (812) 320-03-32

Электронная почта: ocean@oceanchips.ru

Web: <http://oceanchips.ru/>

Адрес: 198099, г. Санкт-Петербург, ул. Калинина, д. 2, корп. 4, лит. А