



Is Now Part of



**ON Semiconductor®**

To learn more about ON Semiconductor, please visit our website at  
[www.onsemi.com](http://www.onsemi.com)

Please note: As part of the Fairchild Semiconductor integration, some of the Fairchild orderable part numbers will need to change in order to meet ON Semiconductor's system requirements. Since the ON Semiconductor product management systems do not have the ability to manage part nomenclature that utilizes an underscore (\_), the underscore (\_) in the Fairchild part numbers will be changed to a dash (-). This document may contain device numbers with an underscore (\_). Please check the ON Semiconductor website to verify the updated device numbers. The most current and up-to-date ordering information can be found at [www.onsemi.com](http://www.onsemi.com). Please email any questions regarding the system integration to [Fairchild\\_questions@onsemi.com](mailto:Fairchild_questions@onsemi.com).

ON Semiconductor and the ON Semiconductor logo are trademarks of Semiconductor Components Industries, LLC dba ON Semiconductor or its subsidiaries in the United States and/or other countries. ON Semiconductor owns the rights to a number of patents, trademarks, copyrights, trade secrets, and other intellectual property. A listing of ON Semiconductor's product/patent coverage may be accessed at [www.onsemi.com/site/pdf/Patent-Marking.pdf](http://www.onsemi.com/site/pdf/Patent-Marking.pdf). ON Semiconductor reserves the right to make changes without further notice to any products herein. ON Semiconductor makes no warranty, representation or guarantee regarding the suitability of its products for any particular purpose, nor does ON Semiconductor assume any liability arising out of the application or use of any product or circuit, and specifically disclaims any and all liability, including without limitation special, consequential or incidental damages. Buyer is responsible for its products and applications using ON Semiconductor products, including compliance with all laws, regulations and safety requirements or standards, regardless of any support or applications information provided by ON Semiconductor. "Typical" parameters which may be provided in ON Semiconductor data sheets and/or specifications can and do vary in different applications and actual performance may vary over time. All operating parameters, including "Typicals" must be validated for each customer application by customer's technical experts. ON Semiconductor does not convey any license under its patent rights nor the rights of others. ON Semiconductor products are not designed, intended, or authorized for use as a critical component in life support systems or any FDA Class 3 medical devices or medical devices with a same or similar classification in a foreign jurisdiction or any devices intended for implantation in the human body. Should Buyer purchase or use ON Semiconductor products for any such unintended or unauthorized application, Buyer shall indemnify and hold ON Semiconductor and its officers, employees, subsidiaries, affiliates, and distributors harmless against all claims, costs, damages, and expenses, and reasonable attorney fees arising out of, directly or indirectly, any claim of personal injury or death associated with such unintended or unauthorized use, even if such claim alleges that ON Semiconductor was negligent regarding the design or manufacture of the part. ON Semiconductor is an Equal Opportunity/Affirmative Action Employer. This literature is subject to all applicable copyright laws and is not for resale in any manner.



# FAN6604 Highly Integrated Green-Mode PWM Controller

## Features

- High-Voltage Startup
- AC Input Brownout Protection with Hysteresis
- Line Compensation by Current Limit
- Low Operating Current: 1.5 mA
- Linearly Decreasing PWM Frequency to 22 kHz with Cycle Skipping
- Frequency Hopping to Reduce EMI Emission
- Fixed PWM Frequency: 65 kHz
- Peak-Current-Mode Control
- Cycle-by-Cycle Current Limiting
- Leading-Edge Blanking (LEB)
- Internal Open-Loop Protection
- GATE Output Maximum Voltage Clamp: 13 V
- V<sub>DD</sub> Under-Voltage Lockout (UVLO)
- V<sub>DD</sub> Over-Voltage Protection (OVP)
- Programmable Over-Temperature Protection (OTP)
- Internal Latch Circuit (OVP, OTP)
- Open-Loop Protection (OLP); Restart for FAN6604MRMX, Latch for FAN6604MLMX
- SENSE Short-Circuit Protection (SSCP)
- Built-in 8 ms Soft-Start Function

## Applications

General-purpose switch-mode power supplies (SMPS) and flyback power converters, including:

- Power Adapters

## Description

The highly integrated FAN6604 PWM controller provides several features to enhance the performance of flyback converters. To minimize standby power consumption, a proprietary Green-Mode function provides off-time modulation to continuously decrease the switching frequency under light-load conditions.

Under zero-load and very light-load conditions, FAN6604 saves PWM pulses by entering "deep" Burst Mode. Burst Mode enables the power supply to meet international power conservation requirements.

FAN6604 also integrates a frequency-hopping function that helps reduce EMI emission of a power supply with minimum line filters. The built-in synchronized slope compensation helps achieve stable peak-current control. Add in current limit to keep constant output power over universal AC input range. The gate output is clamped at 13 V to protect the external MOSFET from over-voltage damage.

Other protection functions include AC input brownout protection with hysteresis, sense pin short-circuit protection, and V<sub>DD</sub> over-voltage protection. For over-temperature protection, an external NTC thermistor can be applied to sense the external switcher's temperature. When V<sub>DD</sub> OVP or OTP are activated, an internal latch circuit is used to latch-off the controller. The Latch Mode is reset when the V<sub>DD</sub> supply is removed.

FAN6604 is available in an 8-pin SOP package.

## Ordering Information

Part Number	Operating Temperature Range	Package	Packing Method
FAN6604MRMX	-40 to +105°C	8-Pin, Small Outline Package (SOP)	Tape & Reel
FAN6604MLMX			

### Application Diagram

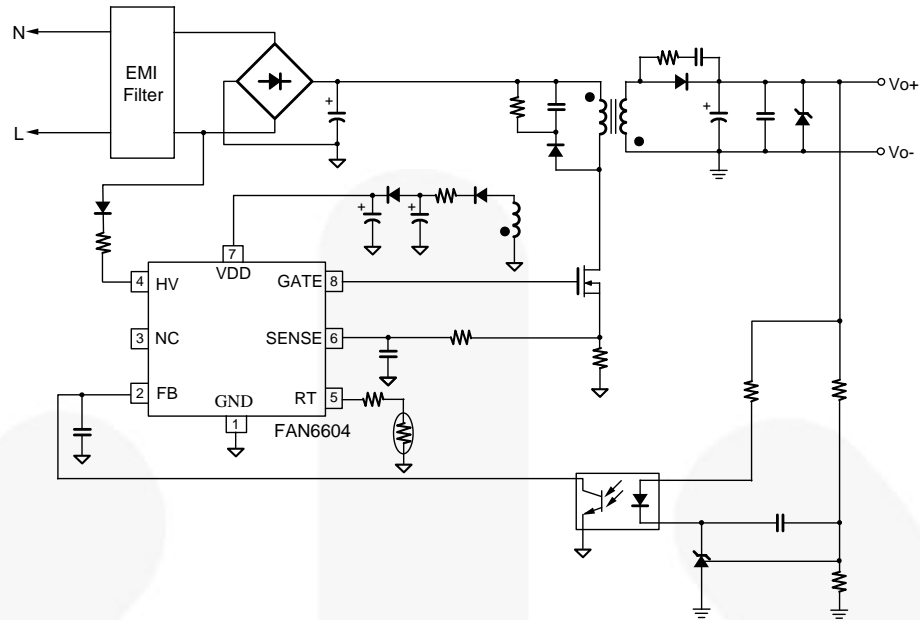

Figure 1. Typical Application

### Internal Block Diagram

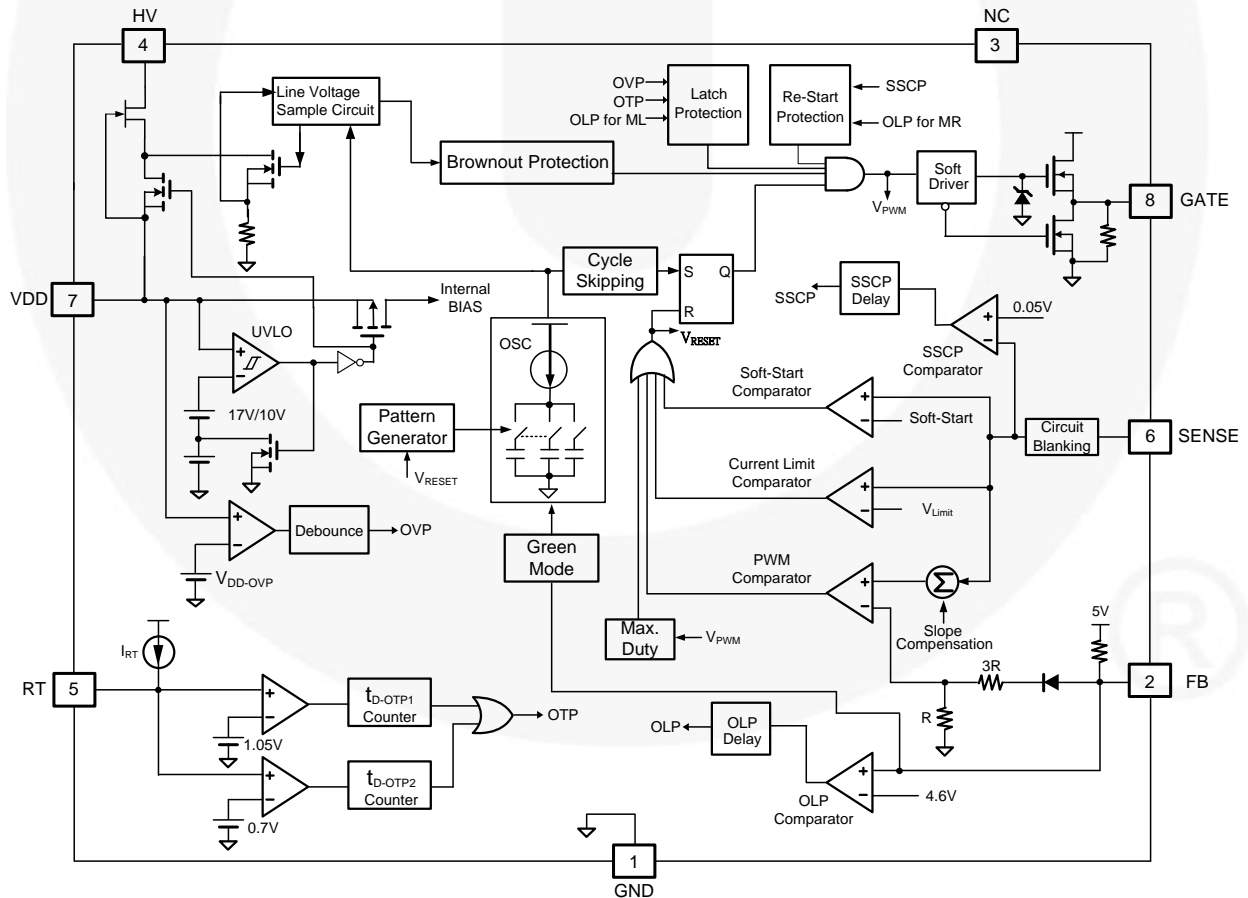

Figure 2. Functional Block Diagram

## Marking Information

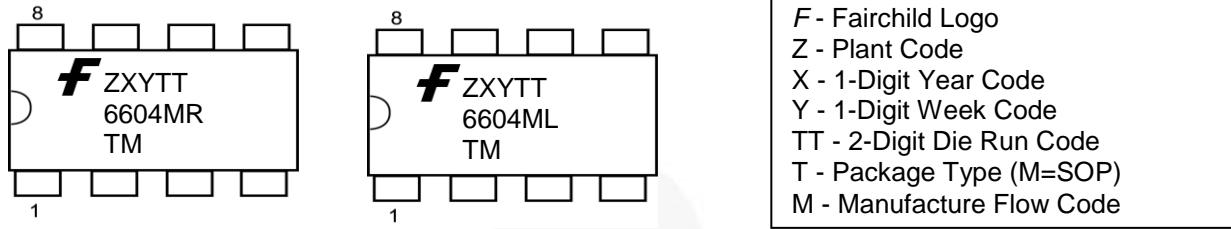

Figure 3. Top Mark

## Pin Configuration

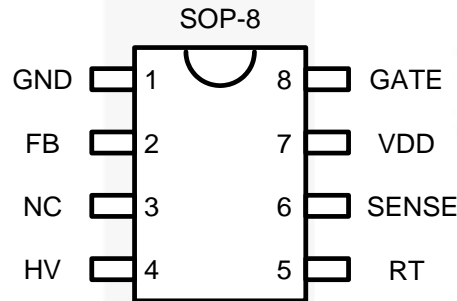

Figure 4. Pin Configuration (Top View)

## Pin Definitions

Pin #	Name	Description
1	GND	<b>Ground.</b> This pin is used for the ground potential of all the pins. A 0.1 $\mu$ F decoupling capacitor placed between VDD and GND is recommended.
2	FB	<b>Feedback.</b> The output voltage feedback information from the external compensation circuit is fed into this pin. The PWM duty cycle is determined by this pin and the current-sense signal from Pin 6. FAN6604 performs open-loop protection (OLP); if the FB voltage is higher than a threshold voltage (around 4.6 V) for more than 56 ms, the controller latches off the PWM.
3	NC	<b>No Connection</b>
4	HV	<b>High-Voltage Startup.</b> This pin is connected to the line input via a 1N4007 and 200 k $\Omega$ resistor to achieve brownout. Once the voltage on the HV pin is lower than the brownout voltage, PWM output turns off.
5	RT	<b>Over-Temperature Protection.</b> An external NTC thermistor is connected from this pin to GND. The impedance of the NTC decreases at high temperatures. Once the voltage on the RT pin drops below the threshold voltage, the controller latches off the PWM. If RT pin is not connected to an NTC resistor for Over-Temperature Protection, a 100 k $\Omega$ resistor is recommend to connect the RT pin to the GND pin. This pin is limited by an internal clamping circuit.
6	SENSE	<b>Current Sense.</b> This pin is used to sense the MOSFET current for the current-mode PWM and current limiting. To achieve high/low line compensation, current limit is built-in.
7	VDD	<b>Supply Voltage.</b> IC operating current and MOSFET driving current are supplied using this pin. This pin is connected to an external bulk capacitor of typically 47 $\mu$ F. The threshold voltages for turn-on and turn-off are 17 V and 10 V, respectively. The operating current is lower than 2 mA.
8	GATE	<b>Gate Drive Output.</b> The totem-pole output driver for the power MOSFET. It is internally clamped below 13 V.

## Absolute Maximum Ratings

Stresses exceeding the absolute maximum ratings may damage the device. The device may not function or be operable above the recommended operating conditions and stressing the parts to these levels is not recommended. In addition, extended exposure to stresses above the recommended operating conditions may affect device reliability. The absolute maximum ratings are stress ratings only.

Symbol	Parameter		Min.	Max.	Unit
V <sub>VDD</sub>	DC Supply Voltage <sup>(1,2)</sup>			30	V
V <sub>FB</sub>	FB Pin Input Voltage		-0.3	6.0	V
V <sub>SENSE</sub>	SENSE Pin Input Voltage		-0.3	6.0	V
V <sub>RT</sub>	RT Pin Input Voltage		-0.3	6.0	V
V <sub>HV</sub>	HV Pin Input Voltage			500	V
P <sub>D</sub>	Power Dissipation (T <sub>A</sub> < 50°C)			400	mW
Θ <sub>JA</sub>	Thermal Resistance (Junction-to-Air)			150	°C/W
T <sub>J</sub>	Operating Junction Temperature		-40	+125	°C
T <sub>STG</sub>	Storage Temperature Range		-55	+150	°C
T <sub>L</sub>	Lead Temperature (Wave Soldering or IR, 10 Seconds)			+260	°C
ESD	Electrostatic Discharge Capability, All Pins Except HV Pin	Human Body Model; JESD22-A114		5000	V
		Charged Device Model; JESD22-C101		2000	

### Notes:

- All voltage values, except differential voltages, are given with respect to the network ground terminal.
- Stresses beyond those listed under Absolute Maximum Ratings may cause permanent damage to the device.
- ESD with HV pin: CDM=1000 V and HBM=1000 V.

## Recommended Operating Conditions

The Recommended Operating Conditions table defines the conditions for actual device operation. Recommended operating conditions are specified to ensure optimal performance to the datasheet specifications. Fairchild does not recommend exceeding them or designing to Absolute Maximum Ratings.

Symbol	Parameter	Min.	Typ.	Max.	Unit
R <sub>HV</sub>	HV Startup Resistor	150	200	250	kΩ

## Electrical Characteristics

$V_{DD}=11\sim 24\text{ V}$  and  $T_A=-40\sim 105^\circ\text{C}$  unless otherwise noted.

Symbol	Parameter	Condition	Min.	Typ.	Max.	Unit
<b>V<sub>DD</sub> Section</b>						
$V_{OP}$	Continuously Operating Voltage				24	V
$V_{DD-ON}$	Start Threshold Voltage		16	17	18	V
$V_{DD-OFF}$	Minimum Operating Voltage		9	10	11	V
$V_{DD-OLP}$	$I_{DD-OLP}$ Off Voltage		5	6.5	8	V
$V_{DD-LH}$	Threshold Voltage on VDD Pin for Latch-Off Release Voltage		3.5	4.0	4.5	V
$V_{DD-AC}$	Threshold Voltage on VDD Pin for Disable AC Recovery to Avoid Startup Failed		$V_{DD-OFF}+2.8$	$V_{DD-OFF}+3.3$	$V_{DD-OFF}+3.8$	V
$I_{DD-ST}$	Startup Current	$V_{DD-ON} - 0.16\text{ V}$			30	$\mu\text{A}$
$I_{DD-OP1}$	Operating Supply Current, PWM Operation	$V_{DD}=20\text{ V}$ , $\text{FB}=3\text{ V}$ Gate Open		1.5	2.0	mA
$I_{DD-OP2}$	Operating Supply Current, Gate Stop	$V_{DD}=20\text{ V}$ , $\text{FB}=3\text{ V}$		1.0	1.5	mA
$I_{LH}$	Operating Current at PWM-Off Phase Under Latch-Off Conduction	$V_{DD}=5\text{ V}$	30	60	90	$\mu\text{A}$
$I_{DD-OLP}$	Internal Sink Current Under Latch-Off Conduction	$V_{DD-OLP}+0.1\text{ V}$ , $T_A=25^\circ\text{C}$	150	180	210	$\mu\text{A}$
$V_{DD-OVP}$	$V_{DD}$ Over-Voltage Protection		24	25	26	V
$t_{D-VDDOVP}$	$V_{DD}$ Over-Voltage Protection Debounce Time		90	180	270	$\mu\text{s}$
<b>HV Section</b>						
$I_{HV}$	Supply Current from HV Pin	$V_{AC}=90\text{ V}$ ( $V_{DC}=120\text{ V}$ ), $V_{DD}=0\text{ V}$ , $T_A=25^\circ\text{C}$	2.0	3.5	5.0	mA
$I_{HV-LC}$	Leakage Current after Startup	$\text{HV}=500\text{ V}$ , $V_{DD}=V_{DD-OFF}+1\text{ V}$		1	20	$\mu\text{A}$
$V_{AC-OFF}$	Brownout Threshold	DC Source Series $R=200\text{ k}\Omega$ to HV Pin See Equation (1)	92	102	112	V
$V_{AC-ON}$	Brown-In Threshold	DC Source Series $R=200\text{ k}\Omega$ to HV Pin See Equation (2)	104	114	124	V
$\Delta V_{AC}$	$V_{AC-ON} - V_{AC-OFF}$	DC Source Series $R=200\text{ k}\Omega$ to HV Pin	6	12	18	V
$t_{S-CYCLE}$	Line Voltage Sample Cycle <sup>(4)</sup>	$\text{FB} > V_{\text{FB-N}}$		220		$\mu\text{s}$
		$\text{FB} < V_{\text{FB-G}}$		650		
$t_{H-TIME}$	Line Voltage Hold Period <sup>(4)</sup>			20		$\mu\text{s}$
$t_{D-AC-OFF}$	PWM Turn-off Debounce Time	$\text{FB} > V_{\text{FB-N}}$	58	70	82	ms
		$\text{FB} < V_{\text{FB-G}}$	150	200	250	ms

**Note:**

4. Guaranteed by design.

Continued on the following page...

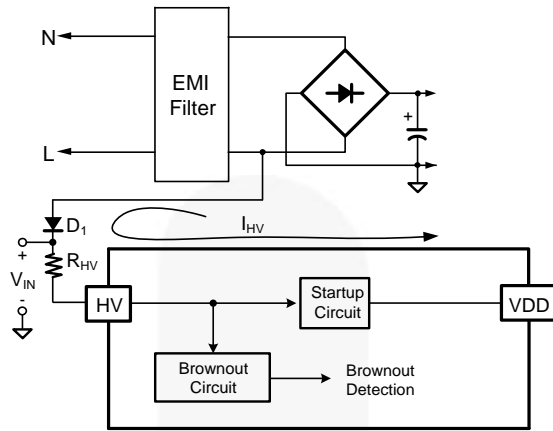

Figure 5. Brownout Circuit

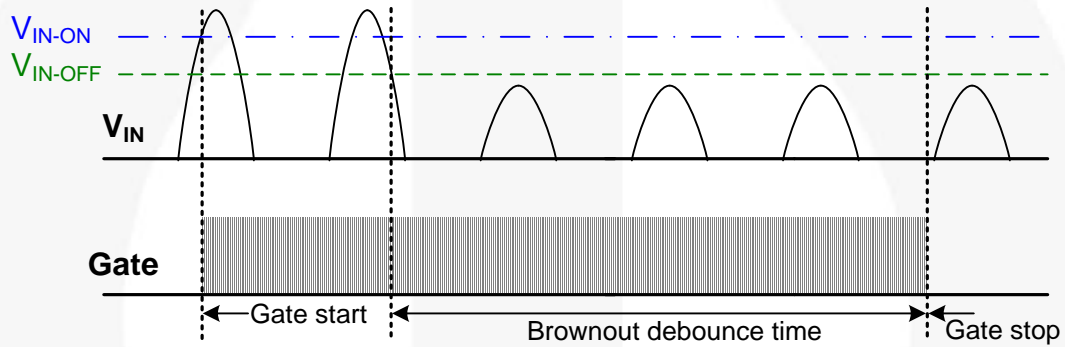

Figure 6. Brownout Behavior

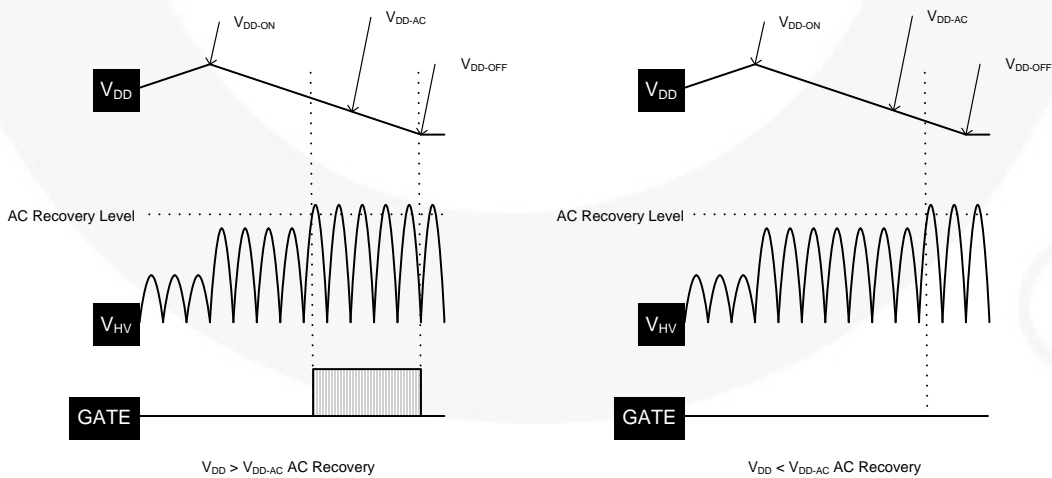

Figure 7.  $V_{DD-AC}$  and AC Recovery

### Electrical Characteristics (Continued)

$V_{DD}=11\sim 24\text{ V}$  and  $T_A=-40\sim 105^\circ\text{C}$  unless otherwise noted.

Symbol	Parameter	Conditions	Min.	Typ.	Max.	Unit
<b>Oscillator Section</b>						
$f_{OSC}$	Frequency in Normal Mode	Center Frequency, $T_A=25^\circ\text{C}$	61	65	69	kHz
		Hopping Range	$\pm 3.7$	$\pm 4.2$	$\pm 4.7$	
$t_{HOP}$	Hopping Period		12.0	13.5	15.0	ms
$f_{OSC-G}$	Green-Mode Frequency		19	22	25	kHz
$f_{DV}$	Frequency Variation vs. $V_{DD}$ Deviation	$V_{DD}=11\text{ V to }22\text{ V}$			5	%
$f_{DT}$	Frequency Variation vs. Temperature Deviation	$T_A=-40\text{ to }+105^\circ\text{C}$			5	%
<b>Feedback Input Section</b>						
$A_V$	Input Voltage to Current-Sense Attenuation		1/4.5	1/4.0	1/3.5	V/V
$Z_{FB}$	Input Impedance		13	15	17	k $\Omega$
$V_{FB-OPEN}$	Output High Voltage	FB Pin Open	4.8	5.0	5.2	V
$V_{FB-OLP}$	FB Open-Loop Trigger Level		4.3	4.6	4.9	V
$t_{D-OLP}$	Delay Time of FB Pin Open-Loop Protection		50	57	64	ms
$V_{FB-N}$	Green-Mode Entry FB Voltage	Pin, FB Voltage ( $FB=V_{FB-N}$ ), $T_A=25^\circ\text{C}$	2.6	2.8	3.0	V
		Hopping Range	$\pm 3.7$	$\pm 4.2$	$\pm 4.7$	kHz
$V_{FB-G}$	Green-Mode Ending FB Voltage	Pin, FB Voltage ( $FB=V_{FB-G}$ )	2.1	2.3	2.5	V
		Hopping Range <sup>(5)</sup>	$\pm 1.27$	$\pm 1.45$	$\pm 1.62$	kHz
$V_{FB-SKIP}$	FB Threshold Voltage for Cycle Skipping Period Divide <sup>(5)</sup>	$(V_{FB-N}+V_{FB-G})/2$	2.35	2.55	2.75	V
$t_{SKIP-N}$	Cycle Skipping Period <sup>(5)</sup>	$V_{FB-SKIP} < V_{FB} < V_{FB-N}$	180	200	220	ms
$t_{SKIP-G}$	Cycle Skipping Period <sup>(5)</sup>	$V_{FB-G} < V_{FB} < V_{FB-SKIP}$	90	100	110	ms
$V_{FB-ZDCR}$	FB Threshold Voltage for Zero-Duty Recovery		1.9	2.1	2.3	V
$V_{FB-ZDC}$	FB Threshold Voltage for Zero-Duty		1.8	2.0	2.2	V

**Note:**

- Guaranteed by design.

Continued on the following page...

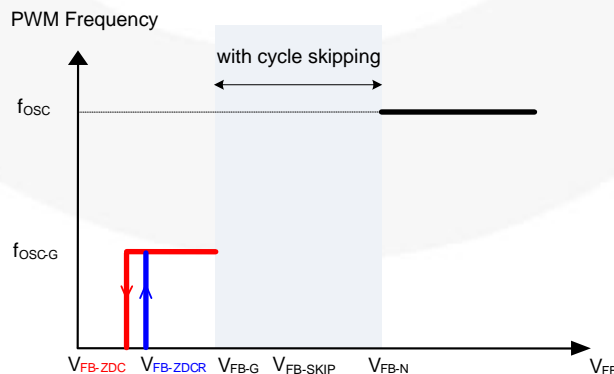

**Figure 8.  $V_{FB}$  vs. PWM Frequency**



**Electrical Characteristics** (Continued)V<sub>DD</sub>=11~24 V and T<sub>A</sub>=-40~105°C unless otherwise noted.

Symbol	Parameter	Conditions	Min.	Typ.	Max.	Unit
<b>Current-Sense Section</b>						
t <sub>PD</sub>	Delay to Output			100	250	ns
t <sub>LEB</sub>	Leading-Edge Blanking Time		210	260	310	ns
V <sub>STHFL</sub>	Flat Threshold Voltage for Current Limit	Duty>62%, FB > V <sub>FB-N</sub>	0.46	0.50	0.54	V
V <sub>STHVA</sub>	Valley Threshold Voltage for Current Limit	Duty=0%	0.31	0.34	0.37	V
V <sub>SSCP</sub>	Threshold Voltage for Sense Short-Circuit Protection		0.03	0.05	0.07	V
t <sub>ON-SSCP</sub>	On Time for V <sub>SSCP</sub> Checking		3.85	4.40	4.95	μs
t <sub>D-SSCP</sub>	Delay for Sense Short-Circuit Protection	V <sub>SENSE</sub> <0.05 V	60	120	180	μs
t <sub>SS</sub>	Soft-Start Time	Startup Time	5.5	7.5	9.5	ms
<b>GATE Section</b>						
DCY <sub>MAX</sub>	Maximum Duty Cycle		75.0	82.5	90.0	%
V <sub>GATE-L</sub>	Gate Low Voltage	V <sub>DD</sub> =15 V, I <sub>O</sub> =50 mA			1.5	V
V <sub>GATE-H</sub>	Gate High Voltage	V <sub>DD</sub> =12 V, I <sub>O</sub> =50 mA	8			V
I <sub>GATE-SINK</sub>	Gate Sink Current <sup>(5)</sup>	V <sub>DD</sub> =15 V	300			mA
I <sub>GATE-SOURCE</sub>	Gate Source Current <sup>(5)</sup>	V <sub>DD</sub> =15 V, GATE=6 V	250			mA
t <sub>r</sub>	Gate Rising Time	V <sub>DD</sub> =15 V, C <sub>L</sub> =1 nF		100		ns
t <sub>f</sub>	Gate Falling Time	V <sub>DD</sub> =15 V, C <sub>L</sub> =1 nF		50		ns
V <sub>GATE-CLAMP</sub>	Gate Output Clamping Voltage	V <sub>DD</sub> =22 V	9	13	17	V
<b>RT Section</b>						
I <sub>RT</sub>	Output Current from RT Pin		92	100	108	μA
V <sub>RTTH1</sub>	Over-Temperature Protection Threshold Voltage	0.7 V < V <sub>RT</sub> < 1.05 V, after 12 ms Latch Off	1.000	1.035	1.070	V
V <sub>RTTH2</sub>		V <sub>RT</sub> < 0.7 V, After 100 μs Latch Off	0.65	0.70	0.75	
t <sub>D-OTP1</sub>	Over-Temperature Latch-Off Debounce	V <sub>RTTH2</sub> < V <sub>RT</sub> < V <sub>RTTH1</sub> FB > V <sub>FB-N</sub>	12	16	20	ms
		V <sub>RTTH2</sub> < V <sub>RT</sub> < V <sub>RTTH1</sub> FB < V <sub>FB-G</sub>	35.5	46.5	57.5	
t <sub>D-OTP2</sub>		V <sub>RT</sub> < V <sub>RTTH2</sub> , FB > V <sub>FB-N</sub>	110	185	260	μs
		V <sub>RT</sub> < V <sub>RTTH2</sub> , FB < V <sub>FB-G</sub>	215	500	785	

**Note:**

6. Guaranteed by design.

## Typical Performance Characteristics

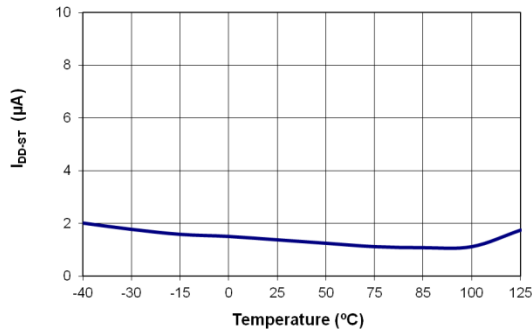

Figure 9. Startup Current ( $I_{DD-ST}$ ) vs. Temperature

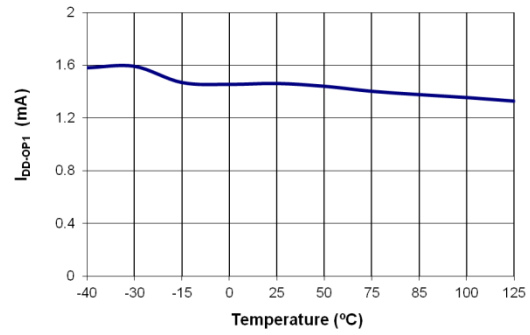

Figure 10. Operation Supply Current ( $I_{DD-OP1}$ ) vs. Temperature

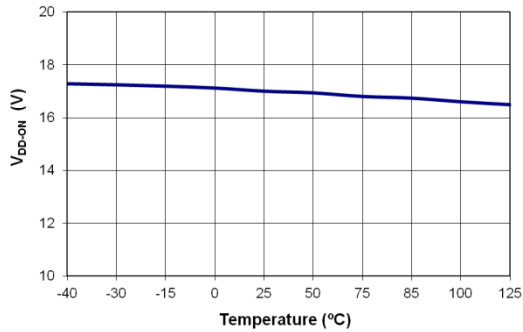

Figure 11. Start Threshold Voltage ( $V_{DD-ON}$ ) vs. Temperature

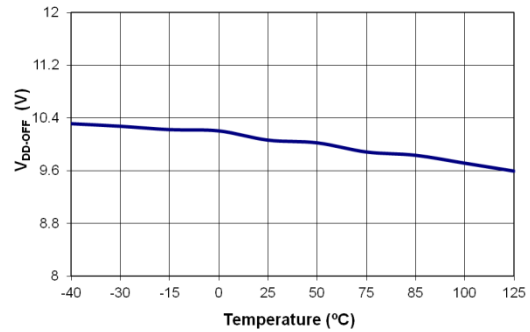

Figure 12. Minimum Operating Voltage ( $V_{DD-OFF}$ ) vs. Temperature

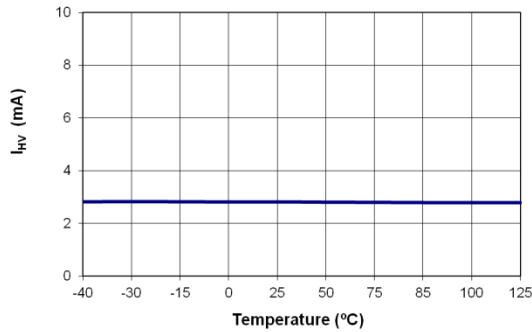

Figure 13. Supply Current Drawn from HV Pin ( $I_{HV}$ ) vs. Temperature

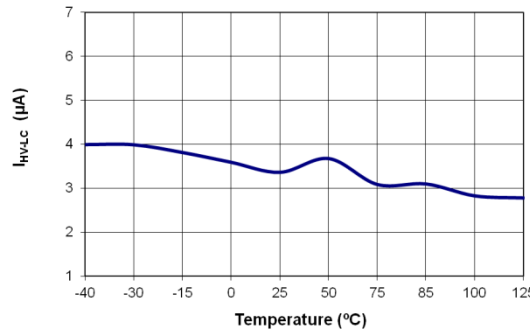

Figure 14. HV Pin Leakage Current After Startup ( $I_{HV-LC}$ ) vs. Temperature

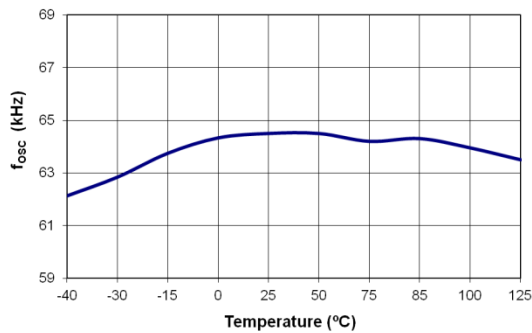

Figure 15. Frequency in Normal Mode ( $f_{osc}$ ) vs. Temperature

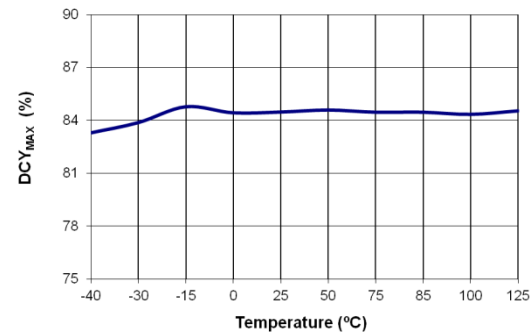
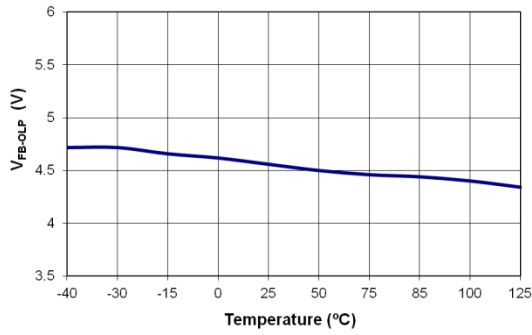
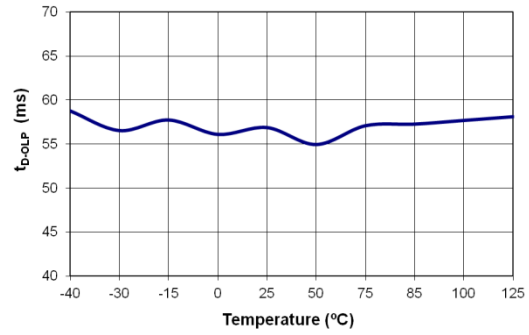

Figure 16. Maximum Duty Cycle ( $DCY_{MAX}$ ) vs. Temperature

**Typical Performance Characteristics (Continued)**



**Figure 17. FB Open-Loop Trigger Level (V<sub>FB-OLP</sub>) vs. Temperature**



**Figure 18. Delay Time of FB Pin Open-Loop Protection (t<sub>D-OLP</sub>) vs. Temperature**

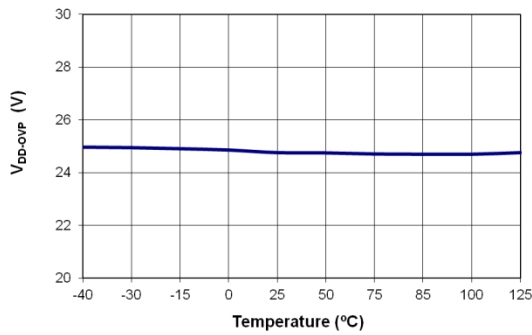

**Figure 19. V<sub>DD</sub> Over-Voltage Protection (V<sub>DD-OVP</sub>) vs. Temperature**

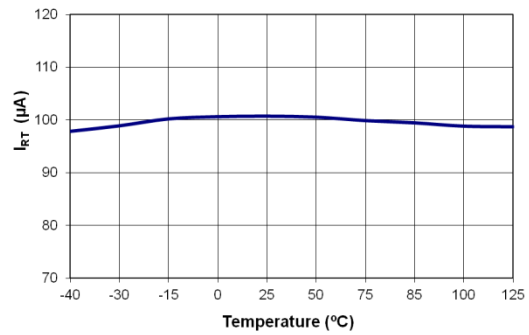

**Figure 20. Output Current from RT Pin (I<sub>RT</sub>) vs. Temperature**

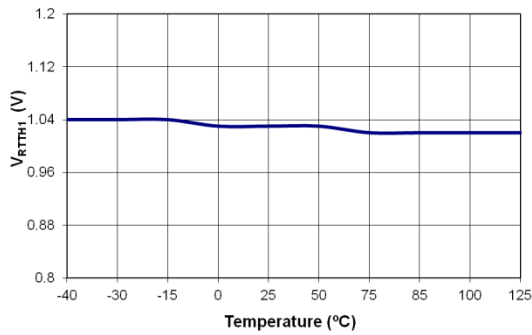

**Figure 21. Over-Temperature Protection Threshold Voltage (V<sub>RTTH1</sub>) vs. Temperature**

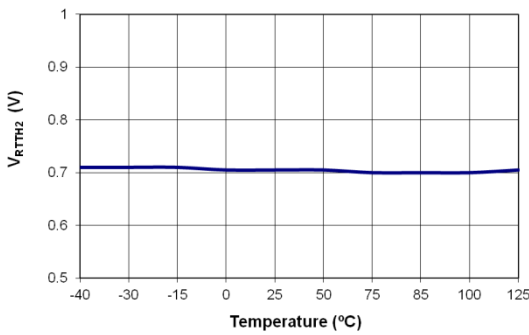

**Figure 22. Over-Temperature Protection Threshold Voltage (V<sub>RTTH2</sub>) vs. Temperature**

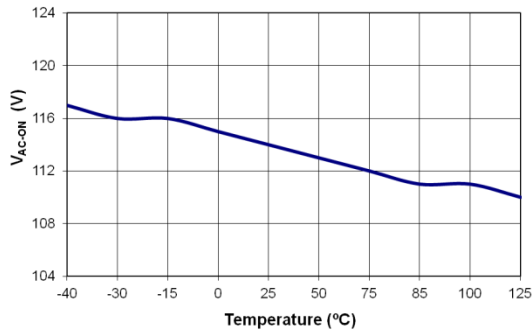

**Figure 23. Brown-In (V<sub>AC-ON</sub>) vs. Temperature**

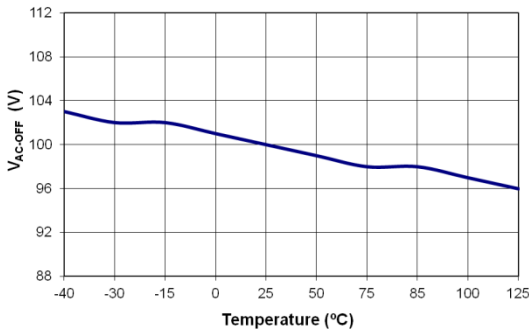

**Figure 24. Brownout (V<sub>AC-OFF</sub>) vs. Temperature**

## Functional Description

### Startup Current

For startup, the HV pin is connected to the line input through an external diode and resistor;  $R_{HV}$ , (1N4007 / 200 k $\Omega$  recommended). Peak startup current drawn from the HV pin is  $(V_{AC} \times \sqrt{2}) / R_{HV}$  and charges the hold-up capacitor through the diode and resistor. When the  $V_{DD}$  capacitor level reaches  $V_{DD-ON}$ , the startup current switches off. At this moment, the  $V_{DD}$  capacitor only supplies the FAN6604 to keep the  $V_{DD}$  until the auxiliary winding of the main transformer provides the operating current.

### Operating Current

Operating current is around 1.5 mA. The low operating current enables better efficiency and reduces the requirement of  $V_{DD}$  hold-up capacitance.

### Green-Mode Operation

The proprietary Green-Mode function provides off-time modulation to reduce the switching frequency in light-load and no-load conditions.  $V_{FB}$ , which is derived from the voltage feedback loop, is taken as the reference. Once  $V_{FB}$  is lower than the threshold voltage ( $V_{FB-N}$ ), the switching frequency is continuously decreased to the minimum Green-Mode frequency of around 22 kHz with cycle skipping.

### Current Sensing / PWM Current Limiting

Peak-current-mode control is utilized to regulate output voltage and provide pulse-by-pulse current limiting. The switch current is detected by a sense resistor into the SENSE pin. The PWM duty cycle is determined by this current-sense signal and  $V_{FB}$ , the feedback voltage. When the voltage on the SENSE pin reaches around  $V_{COMP} = (V_{FB} - 0.6) / 4$ , the switch cycle is terminated immediately.

### Leading-Edge Blanking (LEB)

Each time the power MOSFET is switched on, a turn-on spike occurs on the sense-resistor. To avoid premature termination of the switching pulse, a leading-edge blanking time is built in. During this blanking period, the current-limit comparator is disabled and cannot switch off the gate driver.

### Under-Voltage Lockout (UVLO)

The turn-on and turn-off thresholds are fixed internally at 17 V and 10 V, respectively. During startup, the hold-up capacitor must be charged to 17 V through the startup resistor to enable the IC. The hold-up capacitor continues to supply  $V_{DD}$  until the energy can be delivered from auxiliary winding of the main transformer.  $V_{DD}$  must not drop below 10 V during startup. This UVLO hysteresis window ensures that hold-up capacitor is adequate to supply  $V_{DD}$  during startup.

### Gate Output / Soft Driving

The BiCMOS output stage is a fast totem-pole gate driver. Cross conduction has been avoided to minimize heat dissipation, increase efficiency, and enhance reliability. The output driver is clamped by an internal 13 V Zener diode to protect power MOSFET transistors against undesirable gate over voltage. A soft driving waveform is implemented to minimize EMI.

### Soft-Start

For many applications, it is necessary to minimize the inrush current at startup. The built-in 8 ms soft-start circuit significantly reduces the startup current spike and output voltage overshoot.

### Slope Compensation

The sensed voltage across the current-sense resistor is used for peak-current-mode control and cycle-by-cycle current limiting. Built-in slope compensation improves stability and prevents sub-harmonic oscillation. FAN6604 inserts a synchronized, positive-going, ramp at every switching cycle.

### Constant Output Power Limit

When the SENSE voltage across sense resistor  $R_{SENSE}$  reaches the threshold voltage, the output GATE drive is turned off after a small delay,  $t_{PD}$ . This delay introduces an additional current proportional to  $t_{PD} \cdot V_{IN} / L_P$ . Since the delay is nearly constant, regardless of the input voltage  $V_{IN}$ , higher input voltage results in larger additional power. Therefore, the maximum output power at high line is higher than that of low line. To compensate this variation for a wide AC input range, a current limit uses to solve the unequal power-limit problem. The power limiter is fed to the inverting input of the current limiting comparator. This results in a lower current limit at high-line inputs than at low-line inputs.

### Brownout by the HV Pin

Unlike previous PWM controllers, the FAN6604 HV pin can detect the AC line voltage to perform brownout protection. Using a fast diode and startup resistor to sample the AC line voltage, the peak value refreshes and is stored in a register at each sampling cycle. When internal update time is met, this peak value is used for brownout and current-limit level judgment. Equation (1) and (2) calculate the level of brown-in or brownout converted to RMS value. For power saving, FAN6604 enlarges the sampling cycle to lower the power loss from HV sampling at light-load condition.

$$V_{AC-ON} (RMS) = (0.9V \times \frac{(R_{HV} + 1.6)}{1.6}) / \sqrt{2} \quad (1)$$

$$V_{AC-OFF} (RMS) = (0.81V \times \frac{(R_{HV} + 1.6)}{1.6}) / \sqrt{2} \quad (2)$$

where  $R_{HV}$  is in k $\Omega$ .

### V<sub>DD</sub> Over-Voltage Protection (OVP)

V<sub>DD</sub> over-voltage protection prevents damage due to abnormal conditions. If the V<sub>DD</sub> voltage exceeds the over-voltage protection level (V<sub>DD-OVP</sub>) and lasts for t<sub>D-VDDOVP</sub>, the PWM pulses are disabled and V<sub>DD</sub> begins to drop. As V<sub>DD</sub> drops to V<sub>DD-OLP</sub>, the internal HV startup circuit is activated and V<sub>DD</sub> is charged to V<sub>DD-ON</sub> to restart IC. Over-voltage conditions are usually caused by open feedback loops.

### Sense-Pin Short-Circuit Protection

The FAN6604 provides safety protection for Limited Power Source (LPS) tests. When the sense resistor is shorted by soldering during production, the pulse-by-pulse current limiting loses efficiency for the purpose of providing over-power protection for the unit. The unit may be damaged when the loading is larger than the maximum load. To protect against a short circuit across the current-sense resistor, the controller is designed to immediately shut down if a continuously low voltage (around 0.05 V/120 μs) on the SENSE pin is detected.

### Thermal Protection

An NTC thermistor, R<sub>NTC</sub>, in series with resistor R<sub>A</sub>, can be connected from the RT pin to ground. A constant current, I<sub>RT</sub>, is output from the RT pin. The voltage on the RT pin can be expressed as V<sub>RT</sub>=I<sub>RT</sub> • (R<sub>NTC</sub> + R<sub>PCTC</sub>), where I<sub>RT</sub> is 100 μA. At high ambient temperature, the R<sub>NTC</sub> is smaller and so that V<sub>RT</sub> decreased. When V<sub>RT</sub> is less than 1.035 V (V<sub>RTTH1</sub>), the PWM turns off after 16 ms (t<sub>D-OTP1</sub>). If V<sub>RT</sub> is less than 0.7 V (V<sub>RTTH2</sub>), the PWM turns off after 185 μs (t<sub>D-OTP2</sub>). If the RT pin is not

connected to NTC resistor for over-temperature protection, connecting a series one 100 kΩ resistor to ground to prevent from noise interference is recommended. This pin is limited by an internal clamping circuit.

### Limited Power Control

The FB voltage is pulled HIGH once the power supply cannot sustain the output load, such as during output-short or overload conditions. If the FB voltage remains higher than a built-in threshold for longer than t<sub>D-OLP</sub>, PWM output is turned off. As PWM output is turned off, V<sub>DD</sub> begins decreasing. When V<sub>DD</sub> goes below the turn-off threshold (10 V) the controller is totally shut down and V<sub>DD</sub> is continuously discharged to V<sub>DD-OLP</sub> (6.5 V) by I<sub>DD-OLP</sub> to lower the average input power. This is called two-level UVLO. V<sub>DD</sub> is cycled again. This protection feature continues as long as the overloading condition persists. This prevents the power supply from overheating due to overloading conditions.

### Noise Immunity

Noise on the current sense or control signal may cause significant pulse-width jitter, particularly in continuous-conduction mode. Slope compensation helps alleviate this problem. Good placement and layout practices should be followed. Avoiding long PCB traces and component leads, locating compensation and filter components near the FAN6604, and increasing the power MOS gate resistance improve performance.

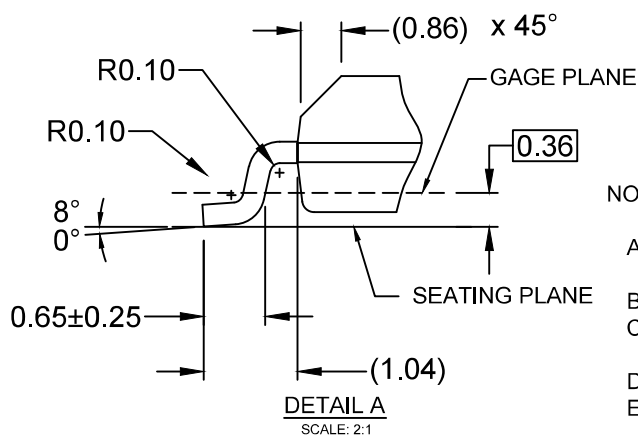
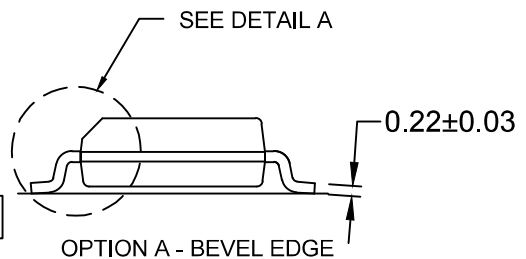
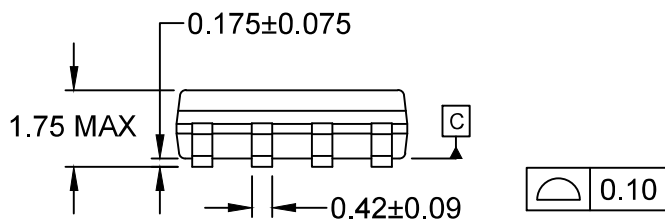
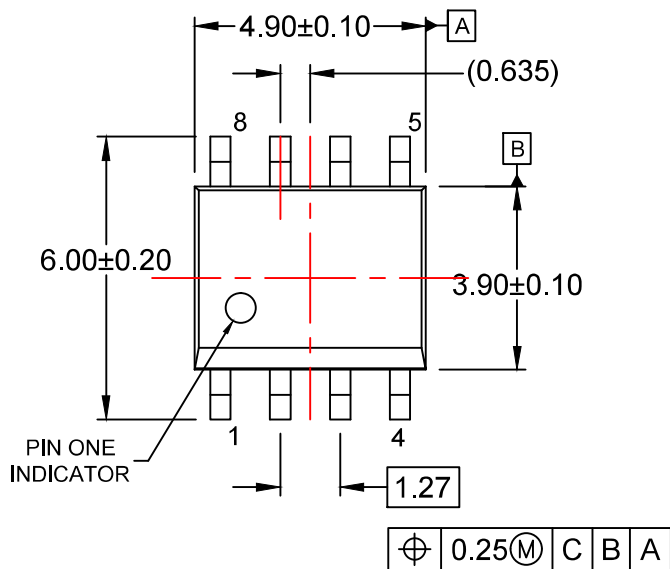

NOTES:

- A) THIS PACKAGE CONFORMS TO JEDEC MS-012, VARIATION AA.
- B) ALL DIMENSIONS ARE IN MILLIMETERS.
- C) DIMENSIONS DO NOT INCLUDE MOLD FLASH OR BURRS.
- D) LANDPATTERN STANDARD: SOIC127P600X175-8M
- E) DRAWING FILENAME: M08Arev16



ON Semiconductor and  are trademarks of Semiconductor Components Industries, LLC dba ON Semiconductor or its subsidiaries in the United States and/or other countries. ON Semiconductor owns the rights to a number of patents, trademarks, copyrights, trade secrets, and other intellectual property. A listing of ON Semiconductor's product/patent coverage may be accessed at [www.onsemi.com/site/pdf/Patent-Marking.pdf](http://www.onsemi.com/site/pdf/Patent-Marking.pdf). ON Semiconductor reserves the right to make changes without further notice to any products herein. ON Semiconductor makes no warranty, representation or guarantee regarding the suitability of its products for any particular purpose, nor does ON Semiconductor assume any liability arising out of the application or use of any product or circuit, and specifically disclaims any and all liability, including without limitation special, consequential or incidental damages. Buyer is responsible for its products and applications using ON Semiconductor products, including compliance with all laws, regulations and safety requirements or standards, regardless of any support or applications information provided by ON Semiconductor. "Typical" parameters which may be provided in ON Semiconductor data sheets and/or specifications can and do vary in different applications and actual performance may vary over time. All operating parameters, including "Typicals" must be validated for each customer application by customer's technical experts. ON Semiconductor does not convey any license under its patent rights nor the rights of others. ON Semiconductor products are not designed, intended, or authorized for use as a critical component in life support systems or any FDA Class 3 medical devices or medical devices with a same or similar classification in a foreign jurisdiction or any devices intended for implantation in the human body. Should Buyer purchase or use ON Semiconductor products for any such unintended or unauthorized application, Buyer shall indemnify and hold ON Semiconductor and its officers, employees, subsidiaries, affiliates, and distributors harmless against all claims, costs, damages, and expenses, and reasonable attorney fees arising out of, directly or indirectly, any claim of personal injury or death associated with such unintended or unauthorized use, even if such claim alleges that ON Semiconductor was negligent regarding the design or manufacture of the part. ON Semiconductor is an Equal Opportunity/Affirmative Action Employer. This literature is subject to all applicable copyright laws and is not for resale in any manner.

## PUBLICATION ORDERING INFORMATION

### LITERATURE FULFILLMENT:

Literature Distribution Center for ON Semiconductor  
19521 E. 32nd Pkwy, Aurora, Colorado 80011 USA  
**Phone:** 303-675-2175 or 800-344-3860 Toll Free USA/Canada  
**Fax:** 303-675-2176 or 800-344-3867 Toll Free USA/Canada  
**Email:** [orderlit@onsemi.com](mailto:orderlit@onsemi.com)

**N. American Technical Support:** 800-282-9855 Toll Free  
USA/Canada  
**Europe, Middle East and Africa Technical Support:**  
Phone: 421 33 790 2910  
**Japan Customer Focus Center**  
Phone: 81-3-5817-1050

**ON Semiconductor Website:** [www.onsemi.com](http://www.onsemi.com)  
**Order Literature:** <http://www.onsemi.com/orderlit>  
For additional information, please contact your local  
Sales Representative

# Mouser Electronics

Authorized Distributor

Click to View Pricing, Inventory, Delivery & Lifecycle Information:

[ON Semiconductor:](#)

[FAN6604MRMX](#) [FAN6604MLMX](#) [FEBFAN6604MR\\_CH11U65A](#) [FEBFAN6604MR-CH11U65A-GEVB](#)



Компания «Океан Электроники» предлагает заключение долгосрочных отношений при поставках импортных электронных компонентов на взаимовыгодных условиях!

Наши преимущества:

- Поставка оригинальных импортных электронных компонентов напрямую с производств Америки, Европы и Азии, а так же с крупнейших складов мира;
- Широкая линейка поставок активных и пассивных импортных электронных компонентов (более 30 млн. наименований);
- Поставка сложных, дефицитных, либо снятых с производства позиций;
- Оперативные сроки поставки под заказ (от 5 рабочих дней);
- Экспресс доставка в любую точку России;
- Помощь Конструкторского Отдела и консультации квалифицированных инженеров;
- Техническая поддержка проекта, помощь в подборе аналогов, поставка прототипов;
- Поставка электронных компонентов под контролем ВП;
- Система менеджмента качества сертифицирована по Международному стандарту ISO 9001;
- При необходимости вся продукция военного и аэрокосмического назначения проходит испытания и сертификацию в лаборатории (по согласованию с заказчиком);
- Поставка специализированных компонентов военного и аэрокосмического уровня качества (Xilinx, Altera, Analog Devices, Intersil, Interpoint, Microsemi, Actel, Aeroflex, Peregrine, VPT, Syfer, Eurofarad, Texas Instruments, MS Kennedy, Miteq, Cobham, E2V, MA-COM, Hittite, Mini-Circuits, General Dynamics и др.);

Компания «Океан Электроники» является официальным дистрибьютором и эксклюзивным представителем в России одного из крупнейших производителей разъемов военного и аэрокосмического назначения «**JONHON**», а так же официальным дистрибьютором и эксклюзивным представителем в России производителя высокотехнологичных и надежных решений для передачи СВЧ сигналов «**FORSTAR**».



## JONHON

«**JONHON**» (основан в 1970 г.)

Разъемы специального, военного и аэрокосмического назначения:

(Применяются в военной, авиационной, аэрокосмической, морской, железнодорожной, горно- и нефтедобывающей отраслях промышленности)

«**FORSTAR**» (основан в 1998 г.)

ВЧ соединители, коаксиальные кабели,  
кабельные сборки и микроволновые компоненты:

(Применяются в телекоммуникациях гражданского и специального назначения, в средствах связи, РЛС, а так же военной, авиационной и аэрокосмической отраслях промышленности).



Телефон: 8 (812) 309-75-97 (многоканальный)

Факс: 8 (812) 320-03-32

Электронная почта: [ocean@oceanchips.ru](mailto:ocean@oceanchips.ru)

Web: <http://oceanchips.ru/>

Адрес: 198099, г. Санкт-Петербург, ул. Калинина, д. 2, корп. 4, лит. А