

Complementary N & P-Channel Power MOSFET

FEATURES

- Low gate charge for fast power switching
- 100% UIS and R_g tested
- Compliant to RoHS directive 2011/65/EU and in accordance to WEEE 2002/96/EC
- Halogen-free according to IEC 61249-2-21

APPLICATIONS

- Building technologies
- DC Fan
- Motor drives

KEY PERFORMANCE PARAMETERS			
PARAMETER	TYPE	VALUE	UNIT
V_{DS}	Q1	60	V
	Q2	-60	
$R_{DS(on)}$ (max)	Q1	$V_{GS} = 10V$	103
		$V_{GS} = 4.5V$	122
	Q2	$V_{GS} = -10V$	180
		$V_{GS} = -4.5V$	220
Q_g	Q1	4.4	nC
	Q2	4.6	

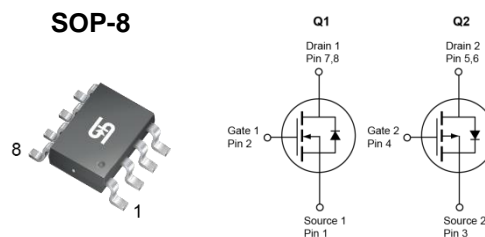

Note: MSL 1 (Moisture Sensitivity Level) per J-STD-020

ABSOLUTE MAXIMUM RATINGS ($T_A = 25^\circ C$ unless otherwise noted)				
PARAMETER	SYMBOL	Q1	Q2	UNIT
Drain-Source Voltage	V_{DS}	60	-60	V
Gate-Source Voltage	V_{GS}	± 20	± 20	V
Continuous Drain Current	I_D	$T_C = 25^\circ C$	5	-4
		$T_A = 25^\circ C$	2.5	-2
Pulsed Drain Current (Note 1)	I_{DM}	20	-16	A
Single Pulse Avalanche Current (Note 2)	I_{AS}	6.8	-7	A
Single Pulse Avalanche Energy (Note 2)	E_{AS}	6.9	7.4	mJ
Total Power Dissipation	P_D	$T_C = 25^\circ C$	5.7	5.7
		$T_C = 125^\circ C$	1.1	1.1
Total Power Dissipation	P_D	$T_A = 25^\circ C$	1.4	1.4
		$T_A = 125^\circ C$	0.3	0.3
Operating Junction and Storage Temperature Range	T_J, T_{STG}	- 55 to +150		$^\circ C$

THERMAL PERFORMANCE			
PARAMETER	SYMBOL	MAXIMUM	UNIT
Thermal Resistance – Junction to Case	$R_{\theta JC}$	22	$^\circ C/W$
Thermal Resistance – Junction to Ambient	$R_{\theta JA}$	88	

Thermal Performance Note: $R_{\theta JA}$ is the sum of the junction-to-case and case-to-ambient thermal resistances. The case-thermal reference is defined at the solder mounting surface of the drain pins. $R_{\theta JC}$ is guaranteed by design while $R_{\theta CA}$ is determined by the user's board design. The $R_{\theta JA}$ limit presented here is based on mounting on a 1 in² pad of 2 oz copper.

ELECTRICAL SPECIFICATIONS ($T_A = 25^\circ\text{C}$ unless otherwise noted)

PARAMETER	CONDITIONS	SYMBOL	TYPE	MIN	TYP	MAX	UNIT		
Static									
Drain-Source Breakdown Voltage	$V_{GS} = 0V, I_D = 250\mu A$	BV_{DSS}	Q1	60	--	--	V		
	$V_{GS} = 0V, I_D = -250\mu A$		Q2	-60	--	--			
Gate Threshold Voltage	$V_{GS} = V_{DS}, I_D = 250\mu A$	$V_{GS(TH)}$	Q1	1.2	1.8	2.5	V		
	$V_{GS} = V_{DS}, I_D = -250\mu A$		Q2	-1	-1.5	-2.5			
Gate-Source Leakage Current	$V_{GS} = \pm 20V, V_{DS} = 0V$	I_{GSS}	Q1	--	--	± 100	nA		
	$V_{GS} = \pm 20V, V_{DS} = 0V$		Q2	--	--	± 100	nA		
Drain-Source Leakage Current	$V_{GS} = 0V, V_{DS} = 60V$	I_{DSS}	Q1	--	--	1	μA		
	$V_{GS} = 0V, V_{DS} = -60V$		Q2	--	--	-1			
Drain-Source On-State Resistance <small>(Note 3)</small>	$V_{GS} = 10V, I_D = 2.5A$	$R_{DS(on)}$	Q1	--	74	103	m Ω		
	$V_{GS} = 4.5V, I_D = 2.3A$			--	86	122			
	$V_{GS} = -10V, I_D = -2A$		Q2	--	135	180			
	$V_{GS} = -4.5V, I_D = -1.7A$			--	170	220			
Forward Transconductance <small>(Note 3)</small>	$V_{DS} = 10V, I_D = 2.5A$	g_{fs}	Q1	--	10	--	S		
	$V_{DS} = -10V, I_D = -2A$		Q2	--	5	--			
Dynamic <small>(Note 4)</small>									
Total Gate Charge	Q1 $V_{DS} = 30V, I_D = 2.5A$ Q2 $V_{DS} = -30V, I_D = -2A$	$Q_{g(VGS=10V)}$	Q1	--	9.4	--	nC		
Total Gate Charge			Q2	--	9	--			
		Gate-Source Charge	$Q_{g(VGS=4.5V)}$	Q1	--	4.4		--	
Q2				--	4.6	--			
Gate-Drain Charge		Q_{gs}	Q1	--	1.8	--			
			Q2	--	1.2	--			
Input Capacitance		Q1 $V_{GS} = 0V, V_{DS} = 30V$	Q_{gd}	Q1	--	2.3		--	pF
				Q2	--	2.4		--	
Output Capacitance	f = 1.0MHz Q2	C_{iss}	Q1	--	527	--			
			Q2	--	436	--			
Reverse Transfer Capacitance	f = 1.0MHz Q1	C_{oss}	Q1	--	31	--			
			Q2	--	32	--			
Gate Resistance	f = 1.0MHz Q1	C_{rss}	Q1	--	4	--			
			Q2	--	11	--			
Turn-On Delay Time	Q1 $V_{GS} = 10V, V_{DS} = 30V,$ $I_D = 2.5A, R_G = 2\Omega$	R_g	Q1	0.5	1.8	3.6	Ω		
			Q2	5	17	34			
Switching <small>(Note 4)</small>									
Turn-On Delay Time	Q1 $V_{GS} = 10V, V_{DS} = 30V,$ $I_D = 2.5A, R_G = 2\Omega$	$t_{d(on)}$	Q1	--	5	--	ns		
			Q2	--	3.4	--			
Turn-On Rise Time	Q2 $V_{GS} = -10V, V_{DS} = -30V,$ $I_D = -2A, R_G = 2\Omega$	t_r	Q1	--	21	--			
			Q2	--	21	--			
Turn-Off Delay Time	Q1 $V_{GS} = 10V, V_{DS} = 30V,$ $I_D = 2.5A, R_G = 2\Omega$	$t_{d(off)}$	Q1	--	10	--			
			Q2	--	21	--			
Turn-Off Fall Time	Q2 $V_{GS} = -10V, V_{DS} = -30V,$ $I_D = -2A, R_G = 2\Omega$	t_f	Q1	--	17	--			
			Q2	--	26	--			

ELECTRICAL SPECIFICATIONS ($T_A = 25^\circ\text{C}$ unless otherwise noted)							
PARAMETER	CONDITIONS	SYMBOL	TYPE	MIN	TYP	MAX	UNIT
Source-Drain Diode							
Forward Voltage (Note 3)	$V_{GS} = 0V, I_S = 2.5A$	V_{SD}	Q1	--	--	1	V
	$V_{GS} = 0V, I_S = -2A$		Q2	--	--	-1	
Reverse Recovery Time	Q1 $I_S = 2.5A, di/dt = 100A/\mu s$	t_{rr}	Q1	--	14	--	ns
			Q2	--	11	--	
Reverse Recovery Charge	Q2 $I_S = -2A, di/dt = 100A/\mu s$	Q_{rr}	Q1	--	10	--	nC
			Q2	--	6	--	

Notes:

1. Current limited by package.
2. Q1 : $L = 0.3mH, V_{GS} = 10V, V_{DD} = 30V, R_G = 25\Omega, I_{AS} = 6.8A$, Starting $T_J = 25^\circ\text{C}$
 Q2 : $L = 0.3mH, V_{GS} = -10V, V_{DD} = -30V, R_G = 25\Omega, I_{AS} = -7A$, Starting $T_J = 25^\circ\text{C}$
3. Pulse test: Pulse Width $\leq 300\mu s$, duty cycle $\leq 2\%$.
4. Switching time is essentially independent of operating temperature.

ORDERING INFORMATION

ORDERING CODE	PACKAGE	PACKING
TSM8588CS RLG	SOP-8	2,500pcs / 13" Reel

CHARACTERISTICS CURVES (Q1 N-Channel)

($T_A = 25^\circ\text{C}$ unless otherwise noted)

Output Characteristics

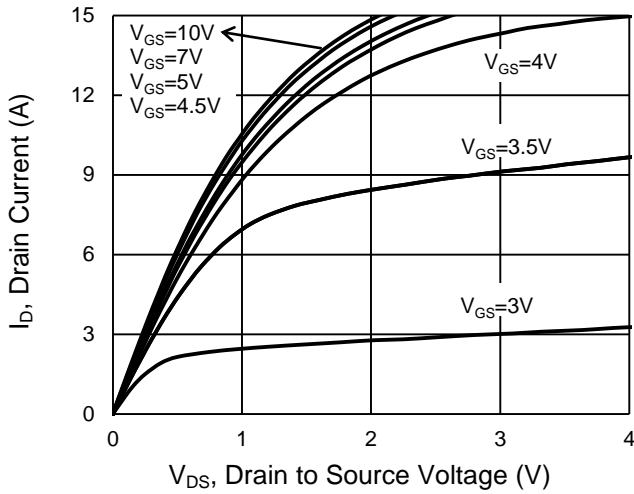

Transfer Characteristics

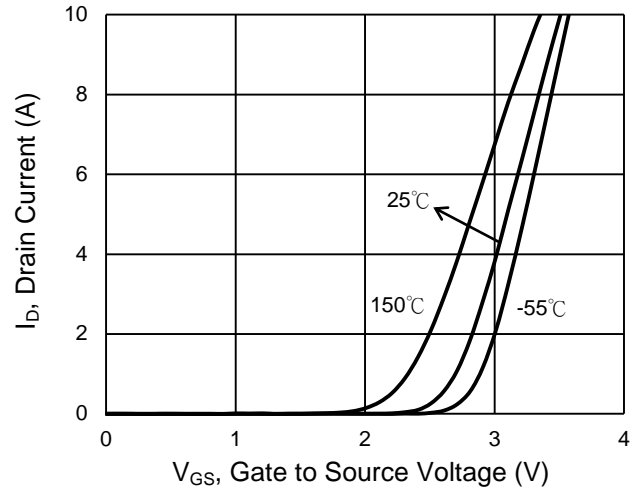

On-Resistance vs. Drain Current

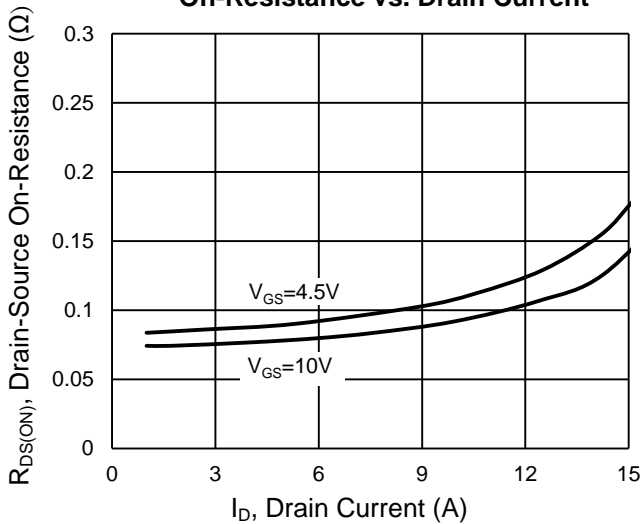

Gate-Source Voltage vs. Gate Charge

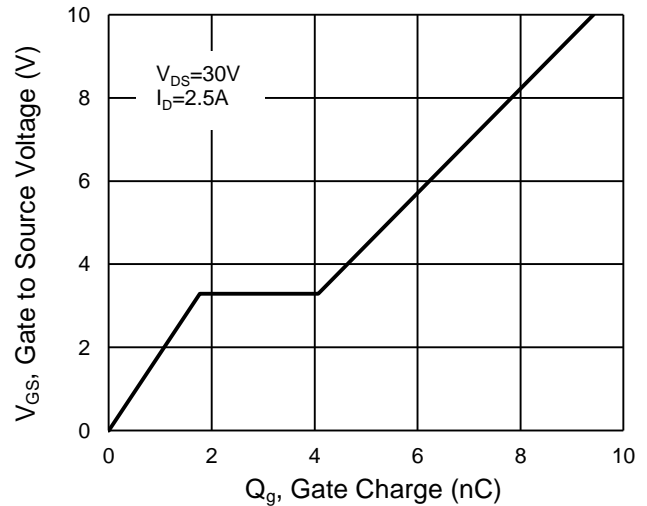

On-Resistance vs. Junction Temperature

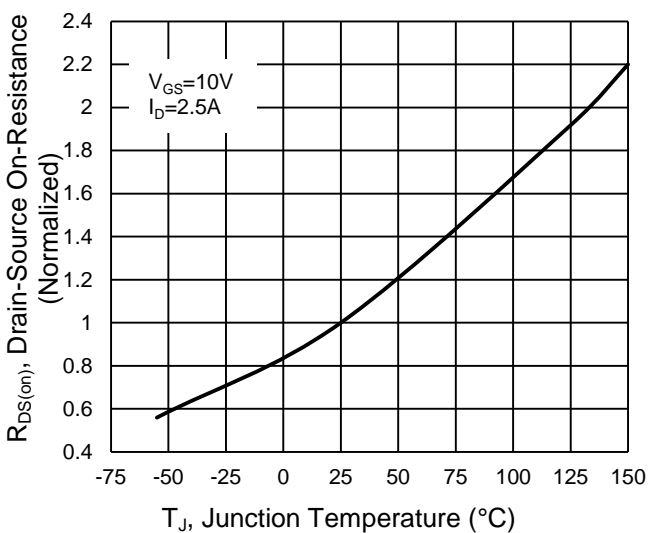

On-Resistance vs. Gate-Source Voltage

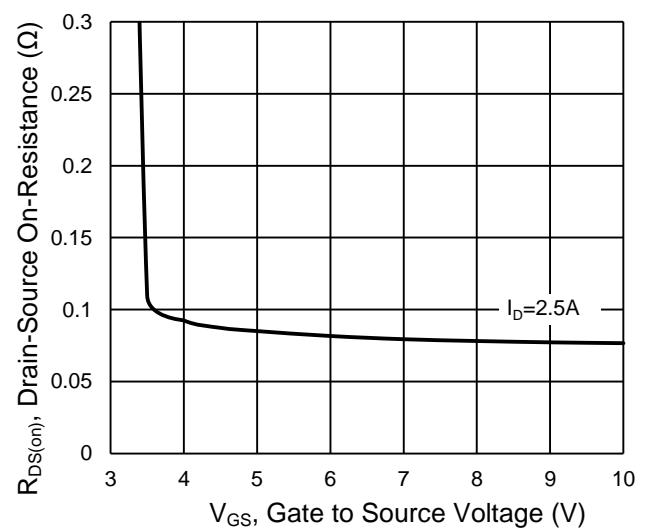

CHARACTERISTICS CURVES

($T_A = 25^\circ\text{C}$ unless otherwise noted)

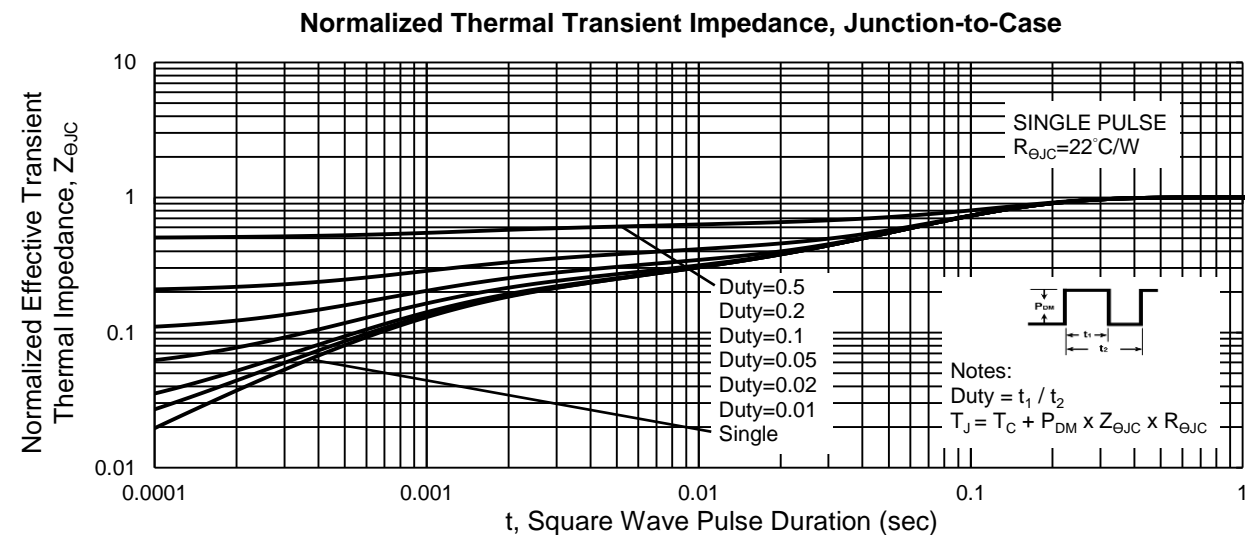
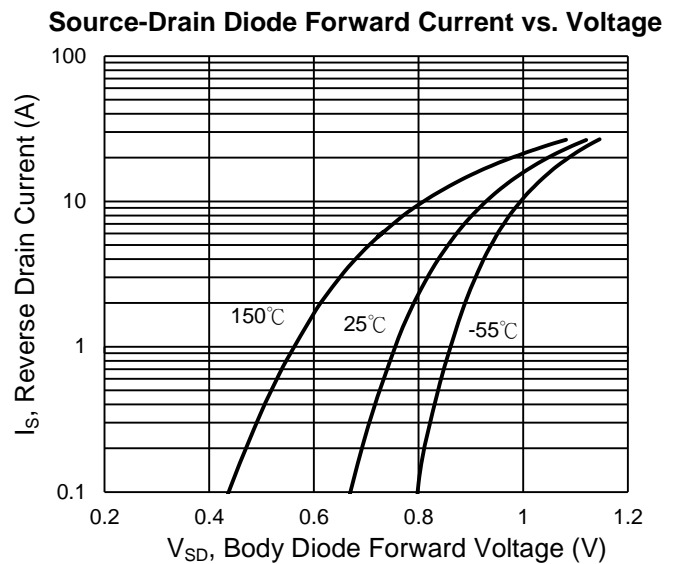
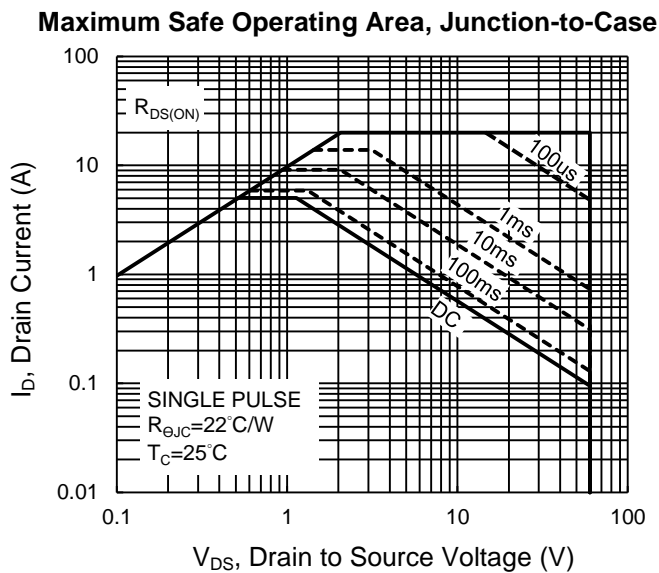
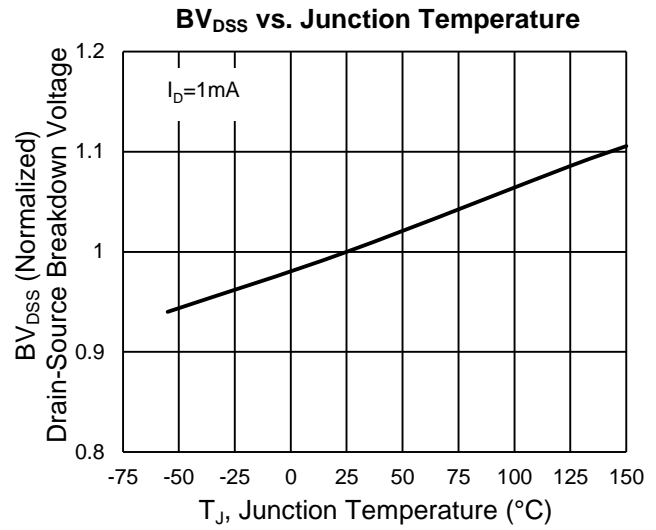
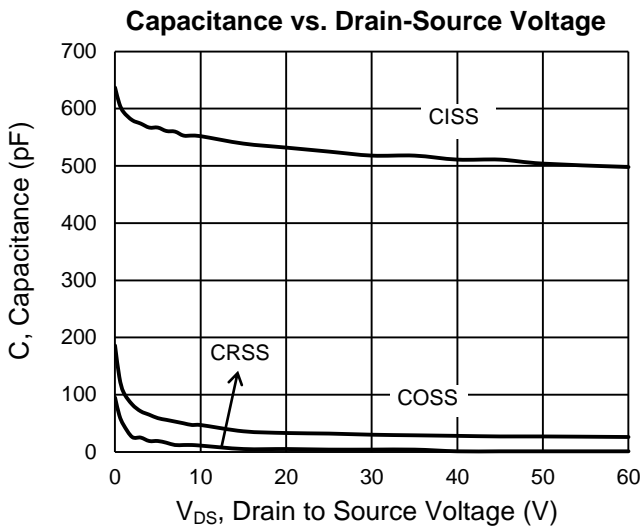

CHARACTERISTICS CURVES (Q2 P-Channel)

($T_A = 25^\circ\text{C}$ unless otherwise noted)

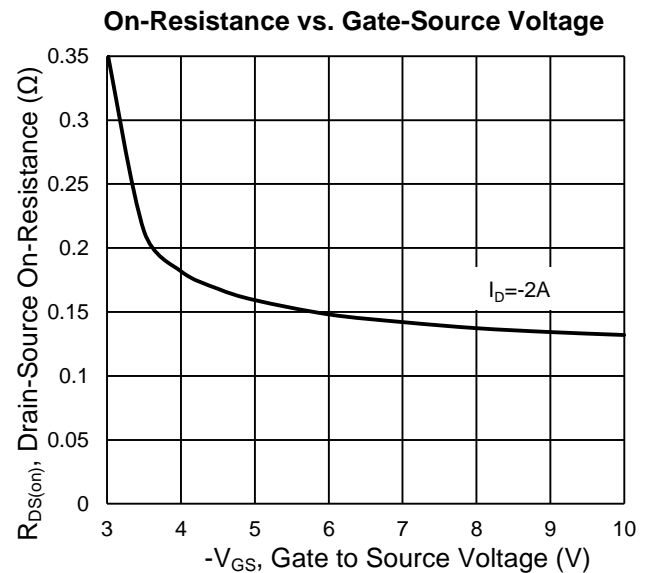
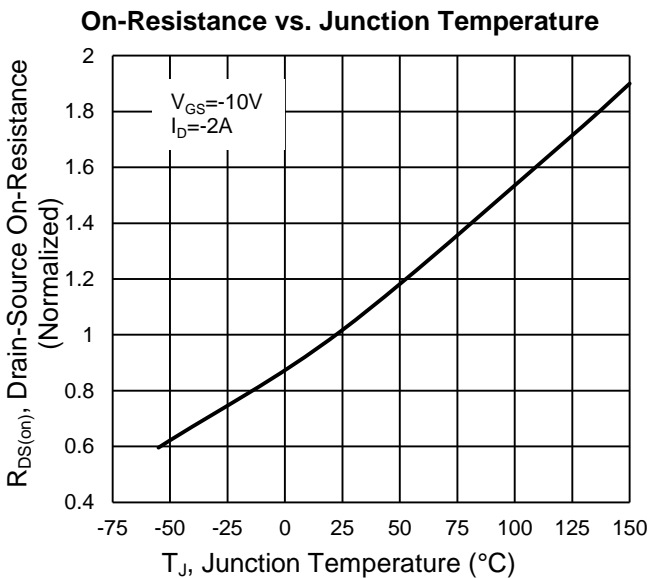
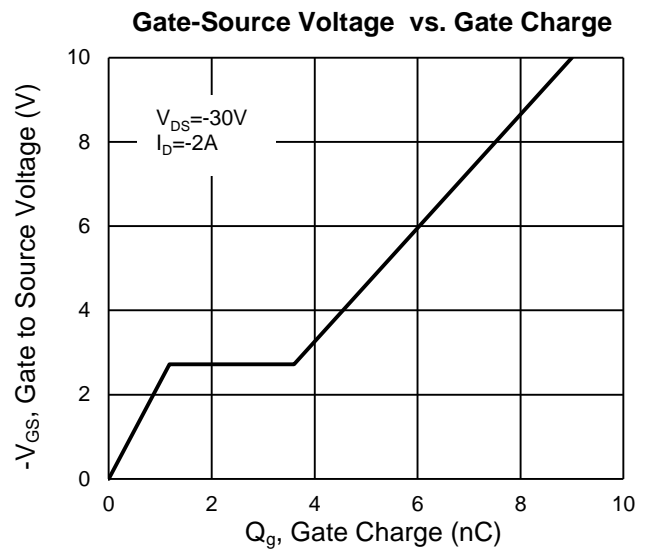
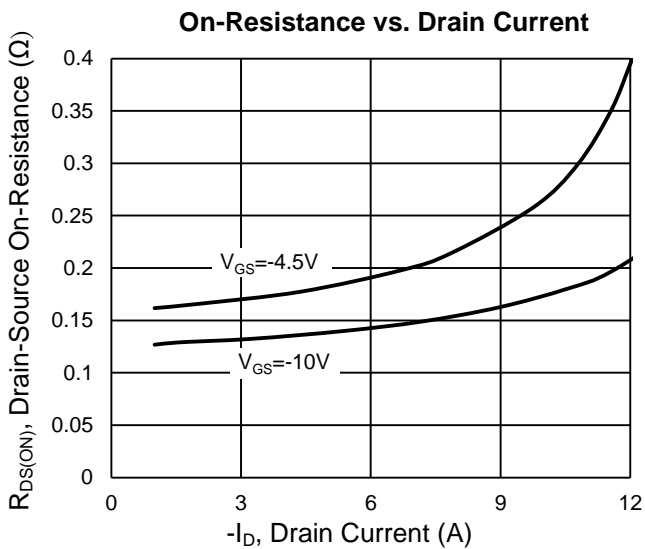
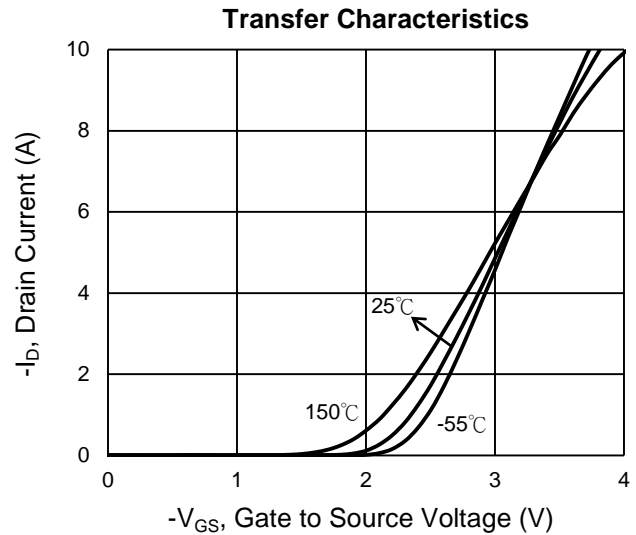
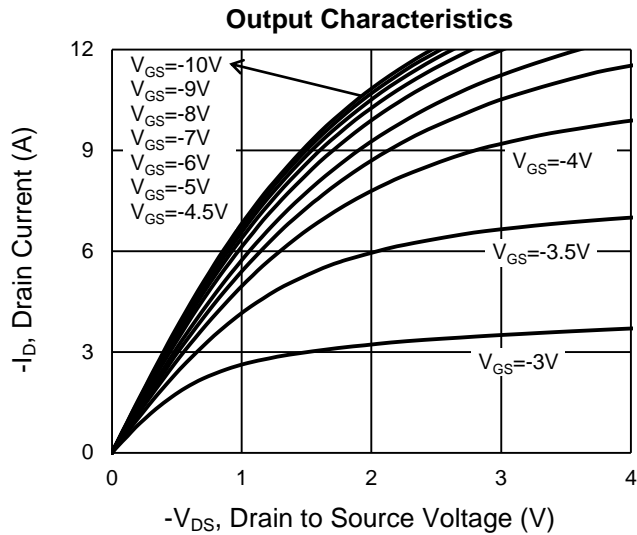

CHARACTERISTICS CURVES

($T_A = 25^\circ\text{C}$ unless otherwise noted)

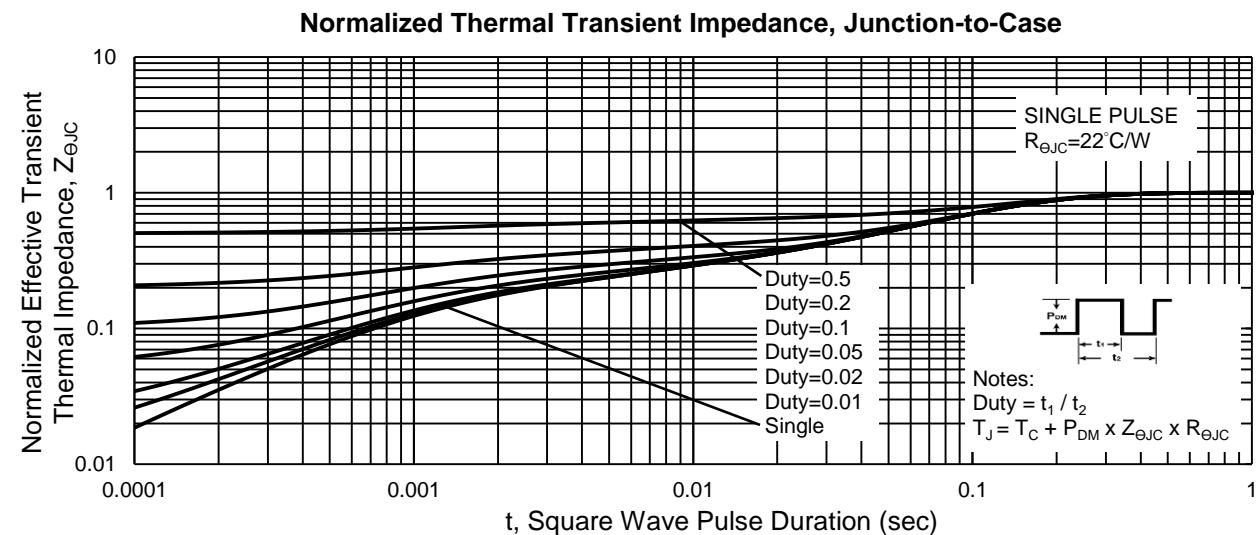
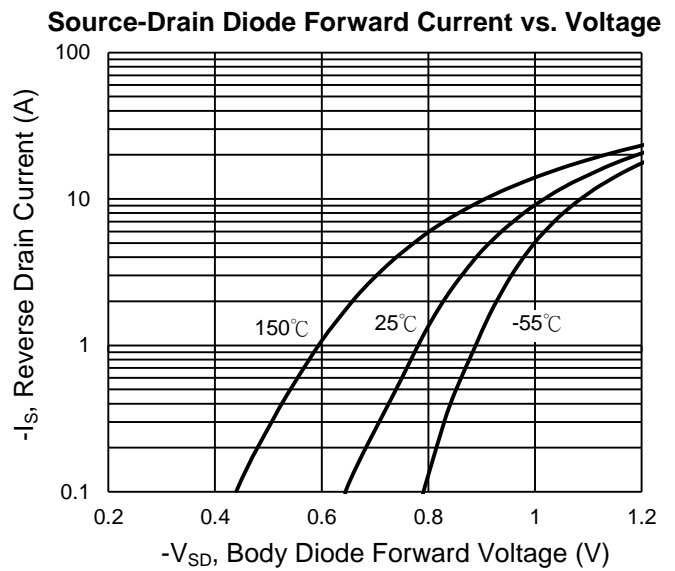
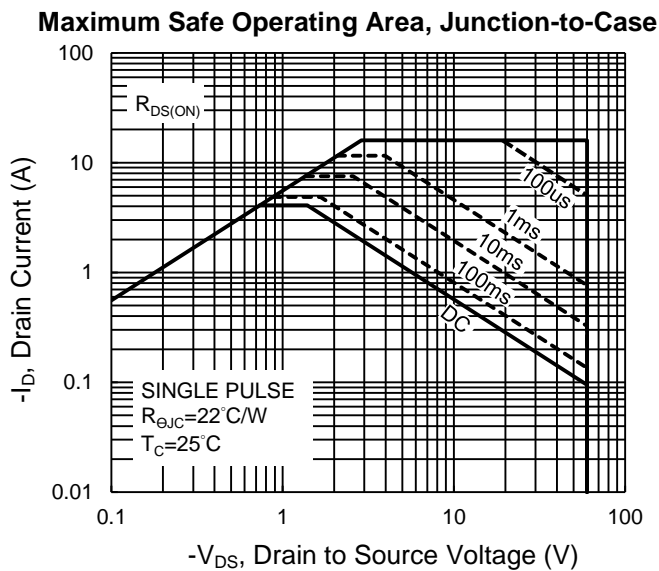
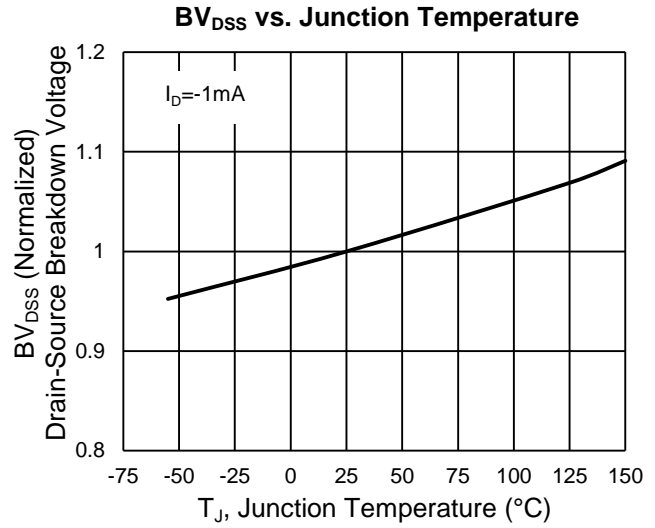
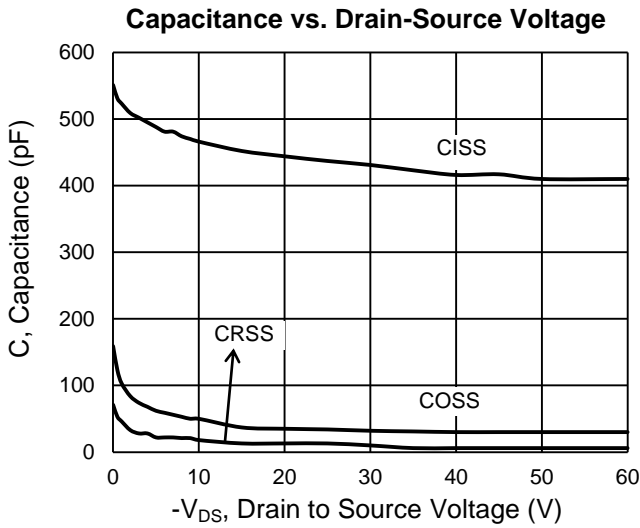

PACKAGE OUTLINE DIMENSIONS (Unit: Millimeters)

SOP-8

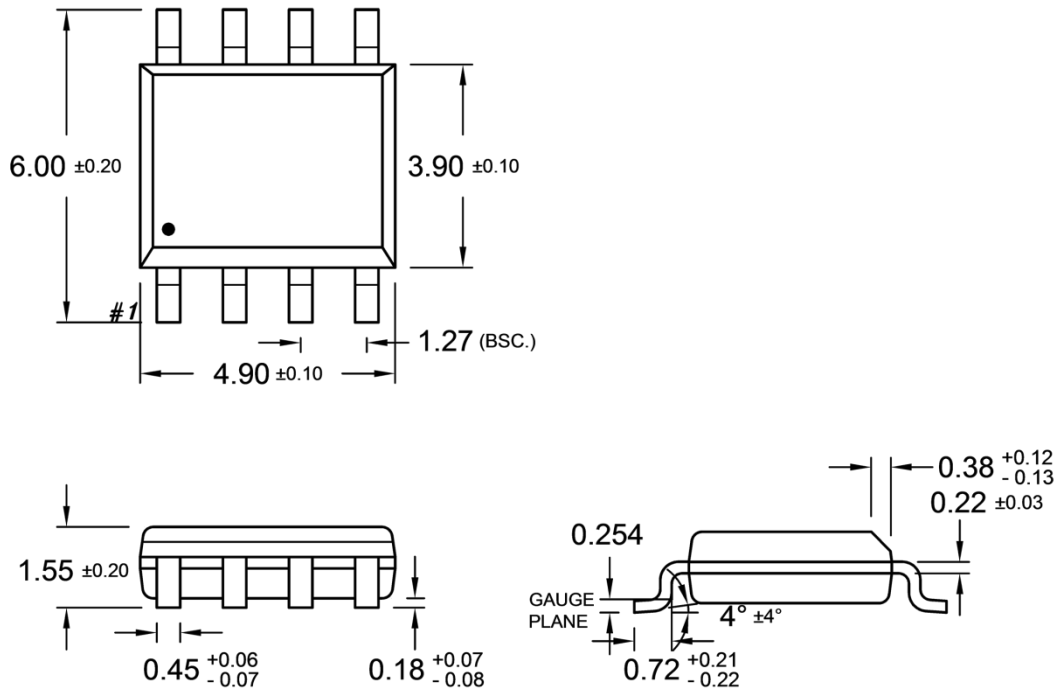

SUGGESTED PAD LAYOUT (Unit: Millimeters)

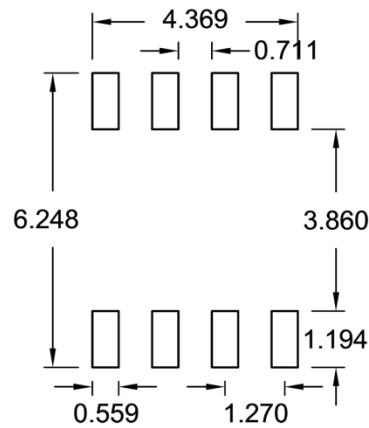

MARKING DIAGRAM

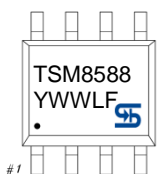

- Y** = Year Code
- WW** = Week Code (01~52)
- L** = Lot Code (1~9,A~Z)
- F** = Factory Code

Notice

Specifications of the products displayed herein are subject to change without notice. TSC or anyone on its behalf, assumes no responsibility or liability for any errors or inaccuracies.

Information contained herein is intended to provide a product description only. No license, express or implied, to any intellectual property rights is granted by this document. Except as provided in TSC's terms and conditions of sale for such products, TSC assumes no liability whatsoever, and disclaims any express or implied warranty, relating to sale and/or use of TSC products including liability or warranties relating to fitness for a particular purpose, merchantability, or infringement of any patent, copyright, or other intellectual property right.

The products shown herein are not designed for use in medical, life-saving, or life-sustaining applications. Customers using or selling these products for use in such applications do so at their own risk and agree to fully indemnify TSC for any damages resulting from such improper use or sale.

Компания «Океан Электроники» предлагает заключение долгосрочных отношений при поставках импортных электронных компонентов на взаимовыгодных условиях!

Наши преимущества:

- Поставка оригинальных импортных электронных компонентов напрямую с производств Америки, Европы и Азии, а так же с крупнейших складов мира;
- Широкая линейка поставок активных и пассивных импортных электронных компонентов (более 30 млн. наименований);
- Поставка сложных, дефицитных, либо снятых с производства позиций;
- Оперативные сроки поставки под заказ (от 5 рабочих дней);
- Экспресс доставка в любую точку России;
- Помощь Конструкторского Отдела и консультации квалифицированных инженеров;
- Техническая поддержка проекта, помощь в подборе аналогов, поставка прототипов;
- Поставка электронных компонентов под контролем ВП;
- Система менеджмента качества сертифицирована по Международному стандарту ISO 9001;
- При необходимости вся продукция военного и аэрокосмического назначения проходит испытания и сертификацию в лаборатории (по согласованию с заказчиком);
- Поставка специализированных компонентов военного и аэрокосмического уровня качества (Xilinx, Altera, Analog Devices, Intersil, Interpoint, Microsemi, Actel, Aeroflex, Peregrine, VPT, Syfer, Eurofarad, Texas Instruments, MS Kennedy, Miteq, Cobham, E2V, MA-COM, Hittite, Mini-Circuits, General Dynamics и др.);

Компания «Океан Электроники» является официальным дистрибьютором и эксклюзивным представителем в России одного из крупнейших производителей разъемов военного и аэрокосмического назначения «JONHON», а так же официальным дистрибьютором и эксклюзивным представителем в России производителя высокотехнологичных и надежных решений для передачи СВЧ сигналов «FORSTAR».



JONHON

«JONHON» (основан в 1970 г.)

Разъемы специального, военного и аэрокосмического назначения:

(Применяются в военной, авиационной, аэрокосмической, морской, железнодорожной, горно- и нефтедобывающей отраслях промышленности)

«FORSTAR» (основан в 1998 г.)

ВЧ соединители, коаксиальные кабели, кабельные сборки и микроволновые компоненты:

(Применяются в телекоммуникациях гражданского и специального назначения, в средствах связи, РЛС, а так же военной, авиационной и аэрокосмической отраслях промышленности).



Телефон: 8 (812) 309-75-97 (многоканальный)

Факс: 8 (812) 320-03-32

Электронная почта: ocean@oceanchips.ru

Web: <http://oceanchips.ru/>

Адрес: 198099, г. Санкт-Петербург, ул. Калинина, д. 2, корп. 4, лит. А