

Ultra low power video buffer/filter with power-down

Features

- Very low consumption: 1.7 mA
- Ultra low power-down mode: 4 nA typ., 500 nA max.
- Internal 6th order reconstruction filter
- Internal gain of 6 dB
- Rail-to-rail output buffer for 75 Ω video line
- Excellent video performance
 - Differential gain 0.5%
 - Differential phase 0.10°
 - Group delay of 10 ns
- SAG correction
- Bottom of video signal close to 0 V
- Tested with 2.5 V and 3.3 V single supply
- Data min. and max. are physically tested and guaranteed during production (consumption, gain, filtering, and other parameters are guaranteed)

Applications

- Mobile phones
- Digital still camera
- Digital video camera
- Portable DVD players

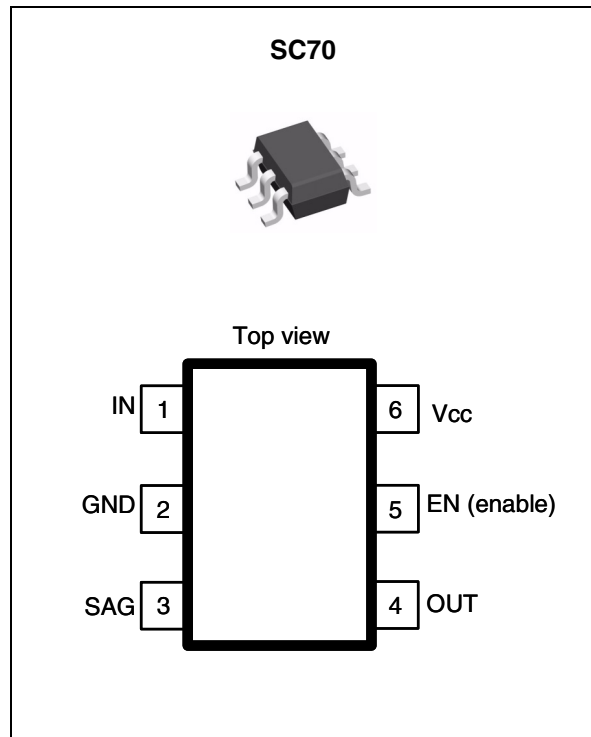

Description

The TSH122 is a video buffer that uses a voltage feedback amplifier, with an internal gain of 6 dB, an output rail-to-rail, an internal input DC-shift and a SAG correction. A power-down function allows switching to a sleep mode with an ultra-low consumption.

The TSH122 features a 6th-order internal reconstruction filter to attenuate the parasitic frequency of 27 MHz from the clock of the video DAC.

The TSH122 operates from 2.25 to 5 V single power supplies and is tested at 2.5 V and 3.3 V.

The TSH122 is a single operator available in a tiny SC70 plastic package for space saving.

1 Absolute maximum ratings and operating conditions

Table 1. Absolute maximum ratings

Symbol	Parameter	Value	Unit
V _{CC}	Supply voltage ⁽¹⁾	5.5	V
V _{in}	Maximum input amplitude	0 to V _{CC}	V
T _{stg}	Storage temperature	-65 to +150	°C
T _j	Maximum junction temperature	150	°C
R _{thja}	SC70 thermal resistance junction to ambient area	205	°C/W
R _{thjc}	SC70 thermal resistance junction to case	172	°C/W
P _{max}	Maximum power dissipation for T _j =150°C		
	T _{amb} = +25°C T _{amb} = +85°C	609 317	mW
ESD	CDM: charged device model ⁽²⁾	1.5	kV
	HBM: human body model ⁽³⁾	1.5	kV
	MM: machine model ⁽⁴⁾	300	V
	Output short-circuit	(5)	

1. All voltage values, except differential voltage, are with respect to network terminal.
2. Charged device model: all pins and the package are charged together to the specified voltage and then discharged directly to the ground through only one pin. This is done for all pins.
3. Human body model: a 100 pF capacitor is charged to the specified voltage, then discharged through a 1.5 kΩ resistor between two pins of the device. This is done for all couples of connected pin combinations while the other pins are floating.
4. Machine model: a 200 pF capacitor is charged to the specified voltage, then discharged directly between two pins of the device with no external series resistor (internal resistor < 5 Ω). This is done for all couples of connected pin combinations while the other pins are floating.
5. An output current limitation protects the circuit from transient currents. Short-circuits can cause excessive heating. Destructive dissipation can result from short-circuits on amplifiers.

Table 2. Operating conditions

Symbol	Parameter	Value	Unit
V _{CC}	Power supply voltage	2.25 to 5 ⁽¹⁾	V
T _{oper}	Operating free air temperature range	-40 to +85	°C

1. Tested in full production at 0 V/2.5 V and 0 V/3.3 V single power supply.

2 Electrical characteristics

Table 3. $V_{CC} = +2.5V, +3.3V, T_{amb} = 25^{\circ}C$ (unless otherwise specified)

Symbol	Parameter	Test conditions	Min.	Typ.	Max.	Unit
DC performance						
V_{dc}	Output DC level shift	$R_L = 150\Omega$	70	115	168	mV
I_{ib}	Input bias current	$V_{CC} = +3.3V$	-1.5	-0.87		μA
		$V_{CC} = +3.3V,$ $T_{min} \leq T_{amb} \leq T_{max}$		-0.93		
G	Internal voltage gain	$V_{in}=0V$ to 1V DC, $V_{CC}=+2.5V$	5.8	6	6.1	dB
		$V_{in}=0V$ to 1.4V DC, $V_{CC}=+3.3V$	5.8	6	6.1	
		$V_{CC}=3.3V$ $T_{min} \leq T_{amb} \leq T_{max}$		5.96		
PSRR	Power supply rejection ratio $20 \log (\Delta V_{CC}/\Delta V_{out})$	$\Delta V_{CC}=\pm 100mV$ at 1kHz $V_{in}=+0.5V$ DC		55		dB
I_{CC}	Positive supply current DC consumption	$V_{in}=0V$, no load $V_{CC}=+3.3V$ $V_{CC}=+2.5V$		2 1.7	2.4 2.1	mA
		$V_{CC}=+3.3V$ $T_{min} \leq T_{amb} \leq T_{max}$		2.4		
Dynamic performance and output characteristics						
BW	Filter bandwidth	Small signal $V_{CC}=+3.3V, R_L = 150\Omega$ -3dB bandwidth -1dB bandwidth	5.4	9.5 7.2		MHz
		-1dB bandwidth $V_{CC} = +3.3V,$ $T_{min} \leq T_{amb} \leq T_{max}$		6.75		
FR	27 MHz rejection	Small signal $V_{CC}=+3.3V, R_L=150\Omega$	36	47		dB
		$V_{CC} = +3.3V,$ $T_{min} \leq T_{amb} \leq T_{max}$		46		dB
ΔG	Differential gain	$V_{CC}=+3.3V, R_L=150\Omega$		0.5		%
$\Delta\Phi$	Differential phase	$V_{CC}=+3.3V, R_L=150\Omega$		0.1		$^{\circ}$
Gd	Group delay	$V_{CC}=+3.3V, 10kHz-5MHz$		6		ns
V_{OH}	High level output voltage	$V_{CC}=+3.3V, R_L=150\Omega$	3.1	3.2		V
		$V_{CC}=+2.5V, R_L=150\Omega$	2.3	2.4		

Table 3. $V_{CC} = +2.5V, +3.3V, T_{amb} = 25^{\circ}C$ (unless otherwise specified) (continued)

Symbol	Parameter	Test conditions	Min.	Typ.	Max.	Unit
V_{OL}	Low level output voltage	$R_L = 150\Omega$		11	40	mV
I_{out}	Output short circuit current	$V_{CC}=+2.5V$		75		mA
Noise and distortion						
eN	Total output noise	$F = 100kHz, \text{no load}$		51		nV/ \sqrt{Hz}
HD	Harmonic distortion	$V_{CC}=+3.3V, R_L = 150\Omega$ $V_{in}=1V_{p-p}, F=1MHz$ H2 H3		64 61		dBc
Enable/power-down Low level on pin-5: TSH122 in power-down High level on pin-5: TSH122 enabled						
I_{sd}	Consumption in power-down mode	$V_{CC}=+3.3V$		4	500	nA
V_{low}	Low-level threshold		0		+0.3	V
V_{high}	High-level threshold		+0.7		V_{CC}	V
T_{on}	Time from power-down to enable			1		μs
T_{off}	Time from enable to power-down			1		μs

Figure 1. Frequency response

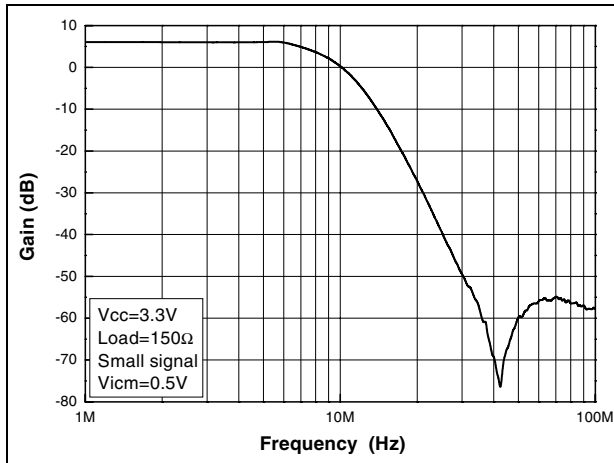

Figure 2. Gain flatness

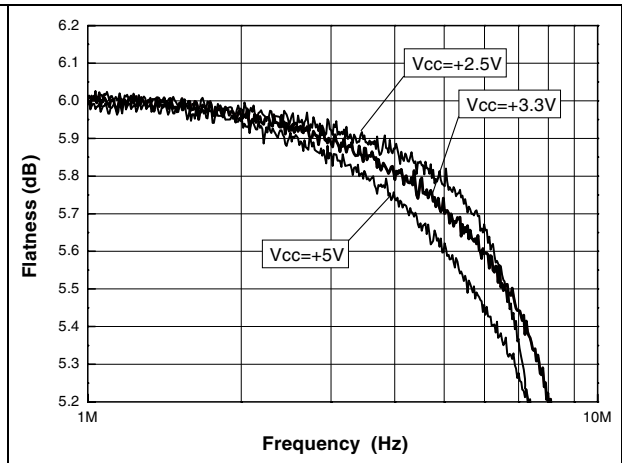

Figure 3. Input noise

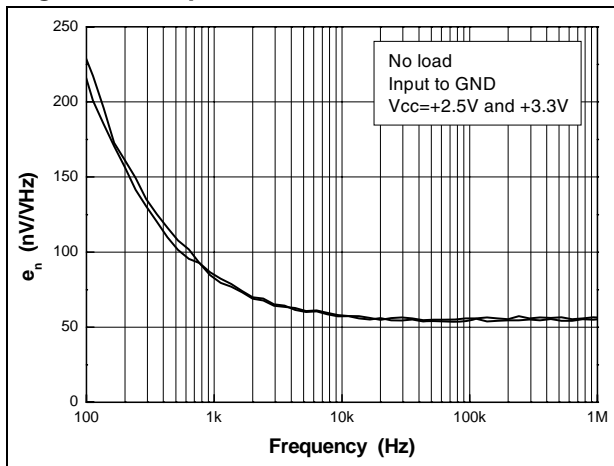

Figure 4. Distortion

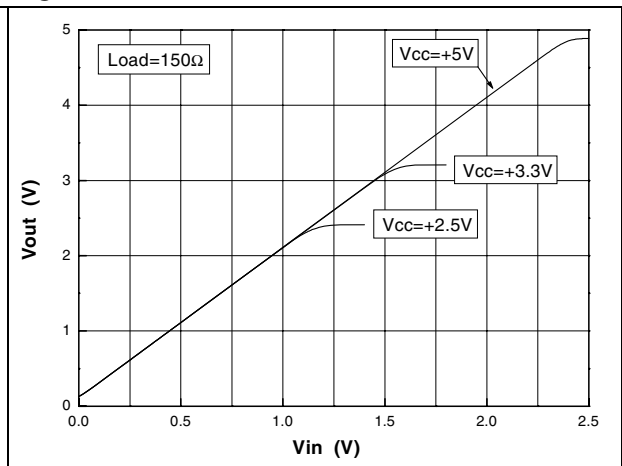

Figure 5. Distortion at Vcc=2.5 V

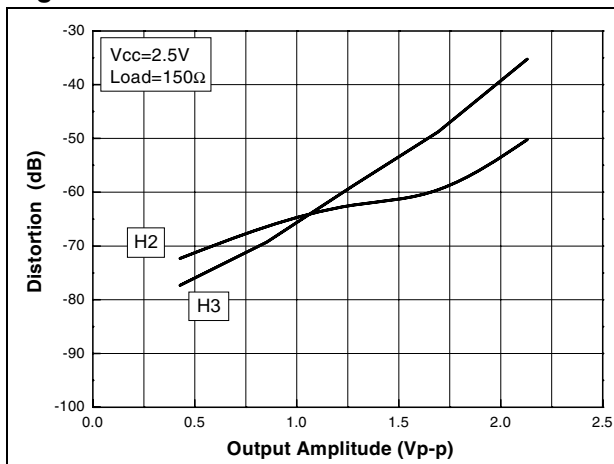

Figure 6. Distortion at Vcc=3.3 V

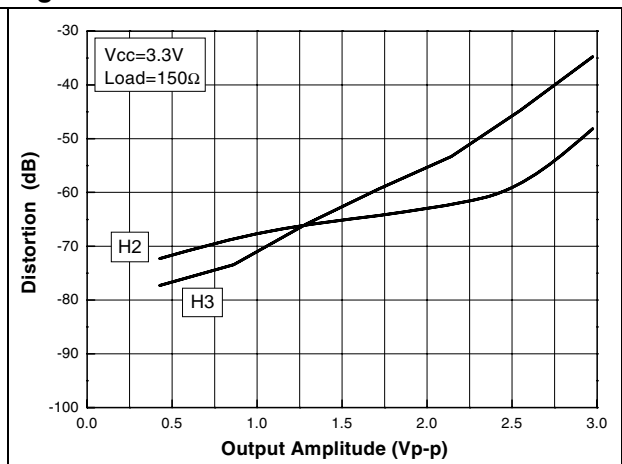

Figure 7. DCshift vs. Vcc

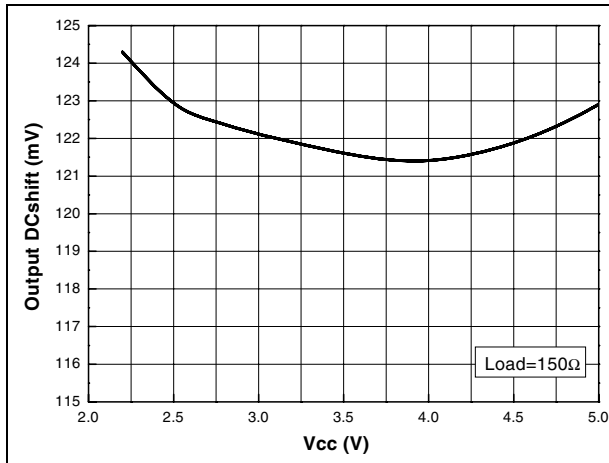

Figure 8. VOL vs. Vcc

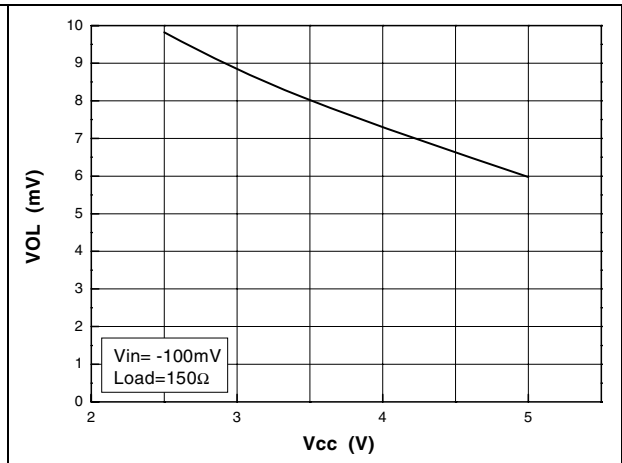

Figure 9. Icc vs. Vcc

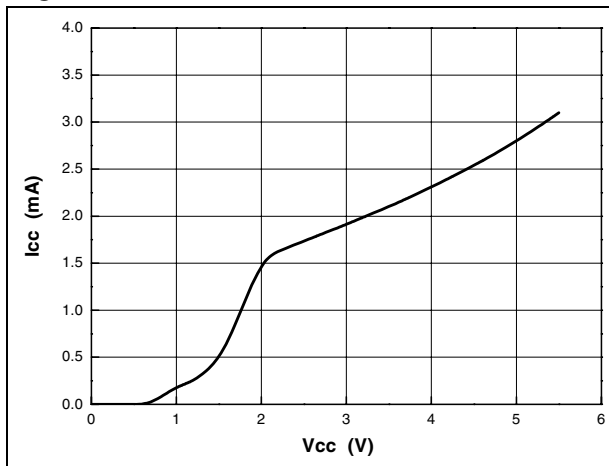

Figure 10. Power down

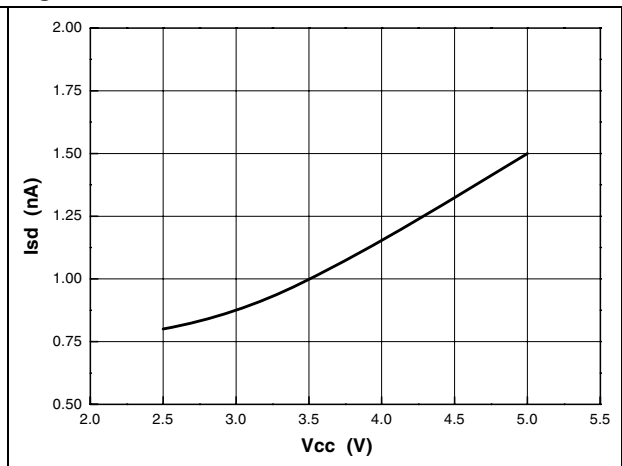

Figure 11. Switch-on output settling

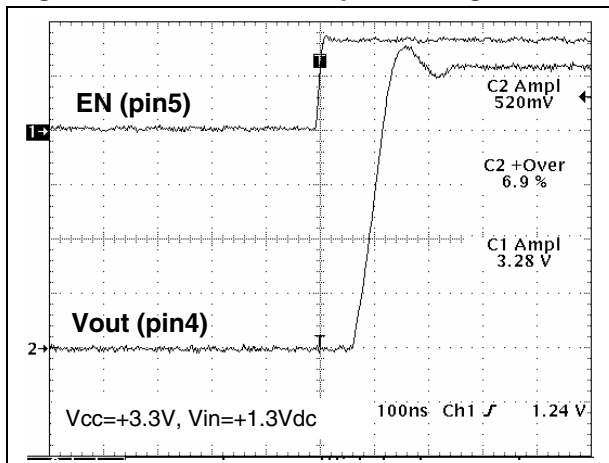

Figure 12. Switch-off output settling

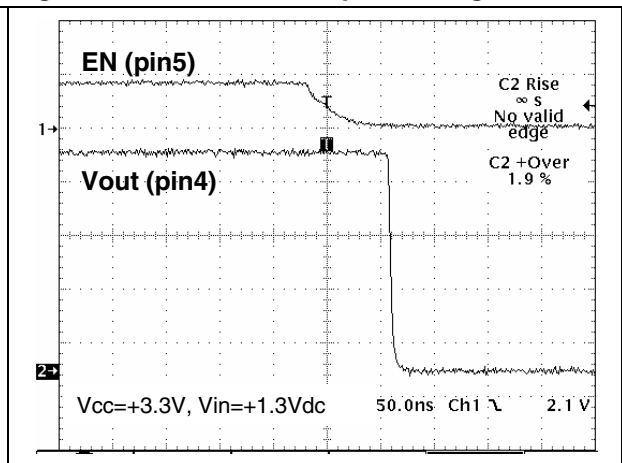

Figure 13. In/Out switch on/off

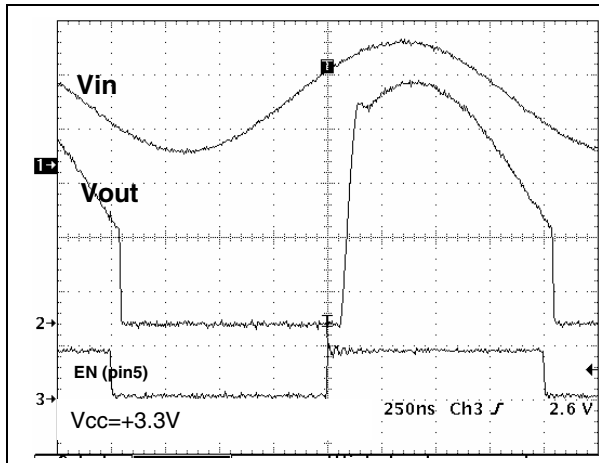

Figure 14. Synchronization tip at 0 V

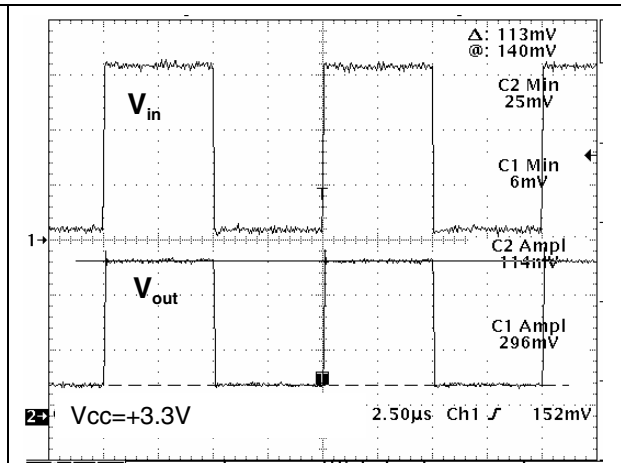

Figure 15. VOL vs. temperature

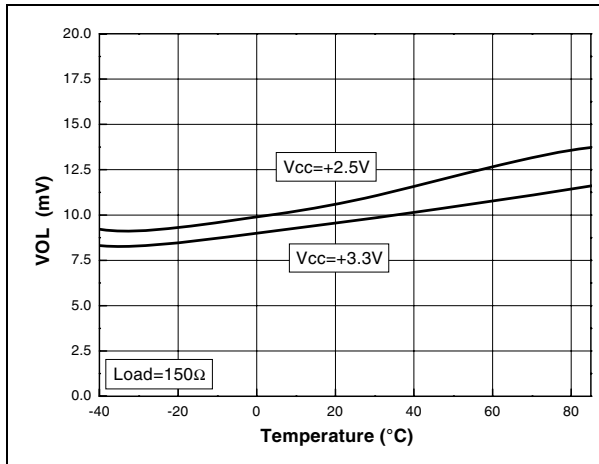

Figure 16. VOH vs. temperature

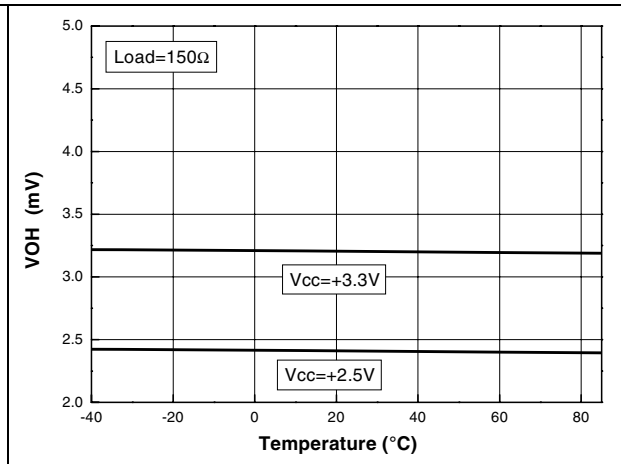

Figure 17. Bandwidth vs. temperature

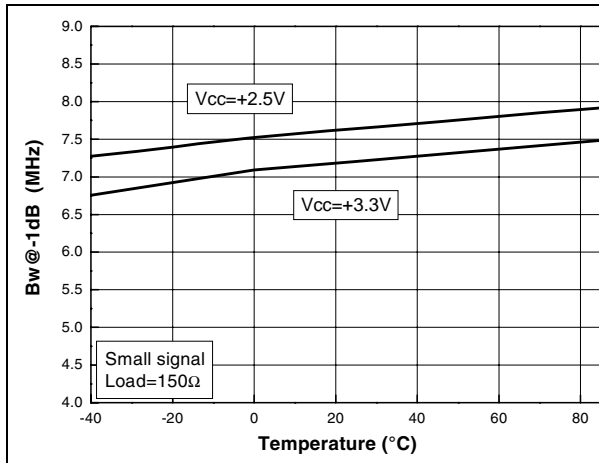

Figure 18. Attenuation vs. temperature

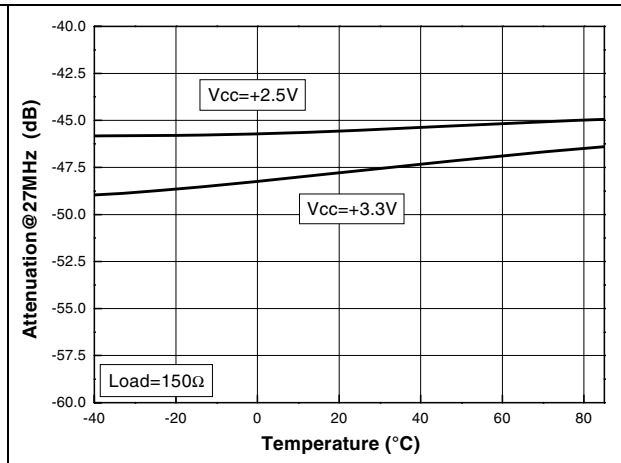

Figure 19. I_{cc} vs. temperature

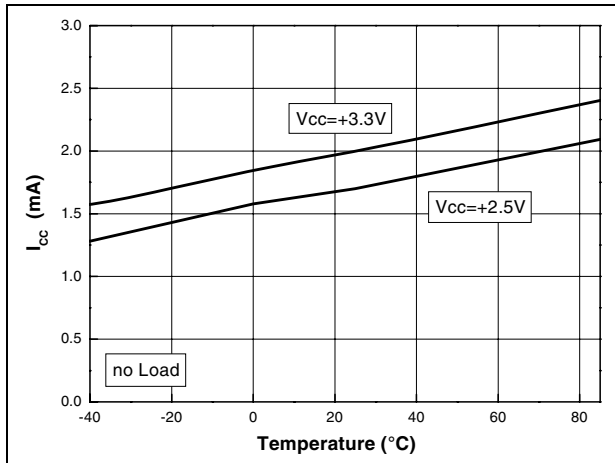

Figure 20. Gain vs. temperature

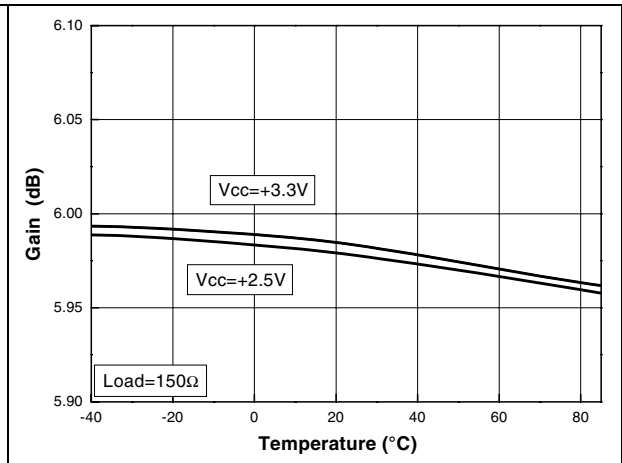

Figure 21. Output DC shift vs. temperature

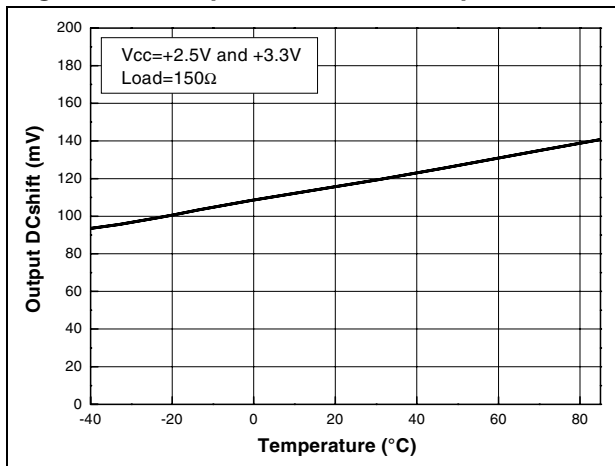
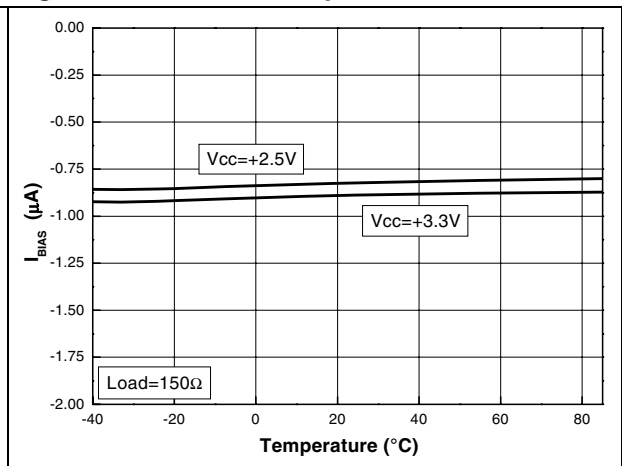

Figure 22. I_{BIAS} vs. temperature



3 Application information

3.1 Power supply considerations

Correct power supply bypassing is very important for optimizing performance in high-frequency ranges. The bypass capacitors should be placed as close as possible to the IC pins to improve high-frequency bypassing. A capacitor greater than $10\ \mu\text{F}$ is necessary to minimize the distortion. For better quality bypassing, we recommend adding a $10\ \text{nF}$ capacitor, also placed as close as possible to the IC pins.

Figure 23. Circuit for power supply bypassing

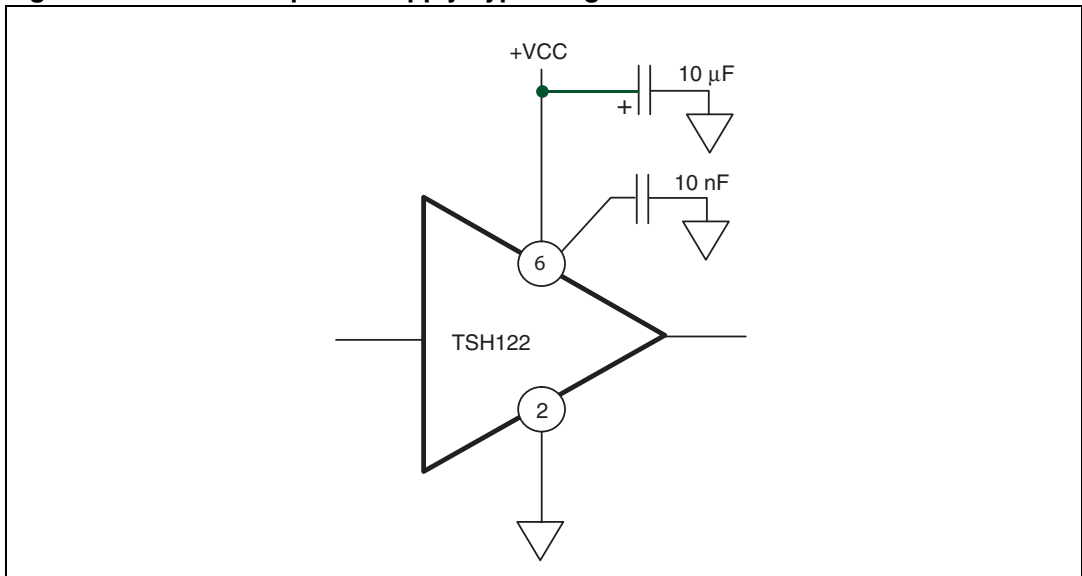
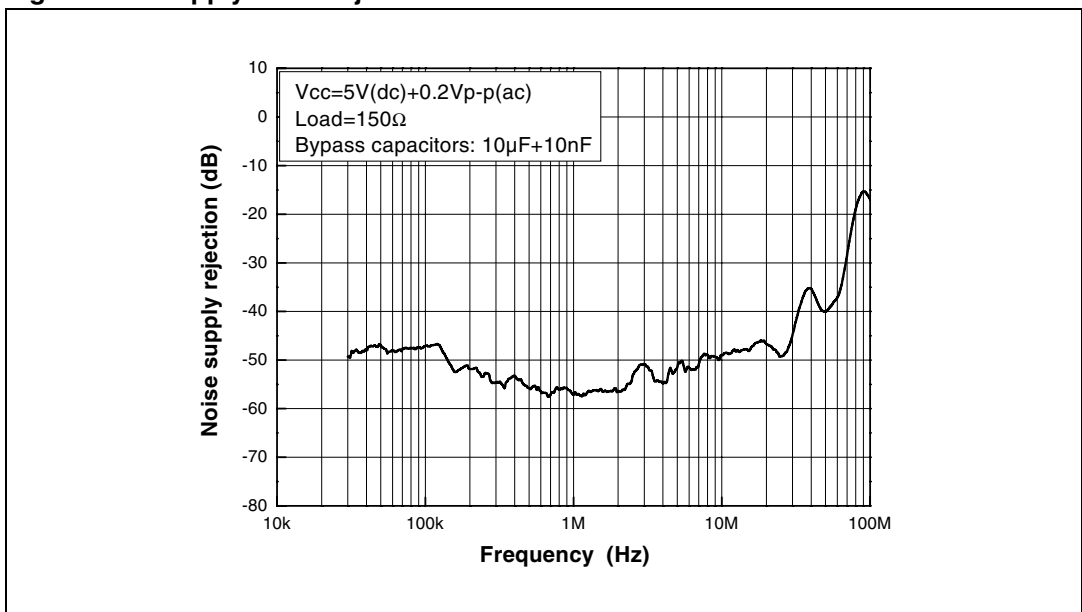

Figure 24. Supply noise rejection



3.2 Implementation considerations

3.2.1 Input

The DC level shifter optimizes the position of the video signal with no clamping on the output rails.

3.2.2 Filter

A reconstruction filter is used to attenuate the DAC's sampling frequency because it generates a parasitic signal in the video spectrum (typically at 27 MHz in the case of standard video). This function is fulfilled while keeping a low group delay and a good gain flatness along the video band.

Figure 25. Internal schematic

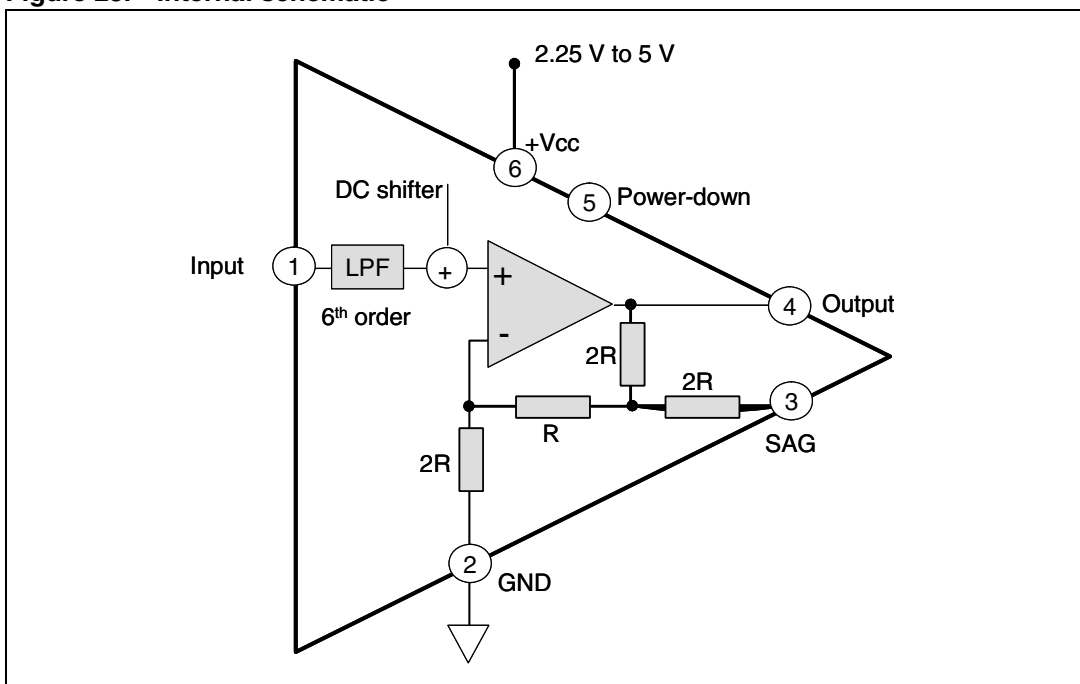

3.2.3 Output

In an AC-coupling configuration, the SAG correction allows use of two small low-cost capacitors in place of one large capacitor (see [Figure 26](#)). The AC-coupling output reduces the power consumption by removing the DC component included in the signal.

Nevertheless, the output can be directly connected to the line without any capacitor. In this case, the OUT and SAG pins are connected together and the equivalent gain of the buffer remains at 6 dB (see [Figure 27](#)).

Figure 26. Schematic diagram with output capacitor

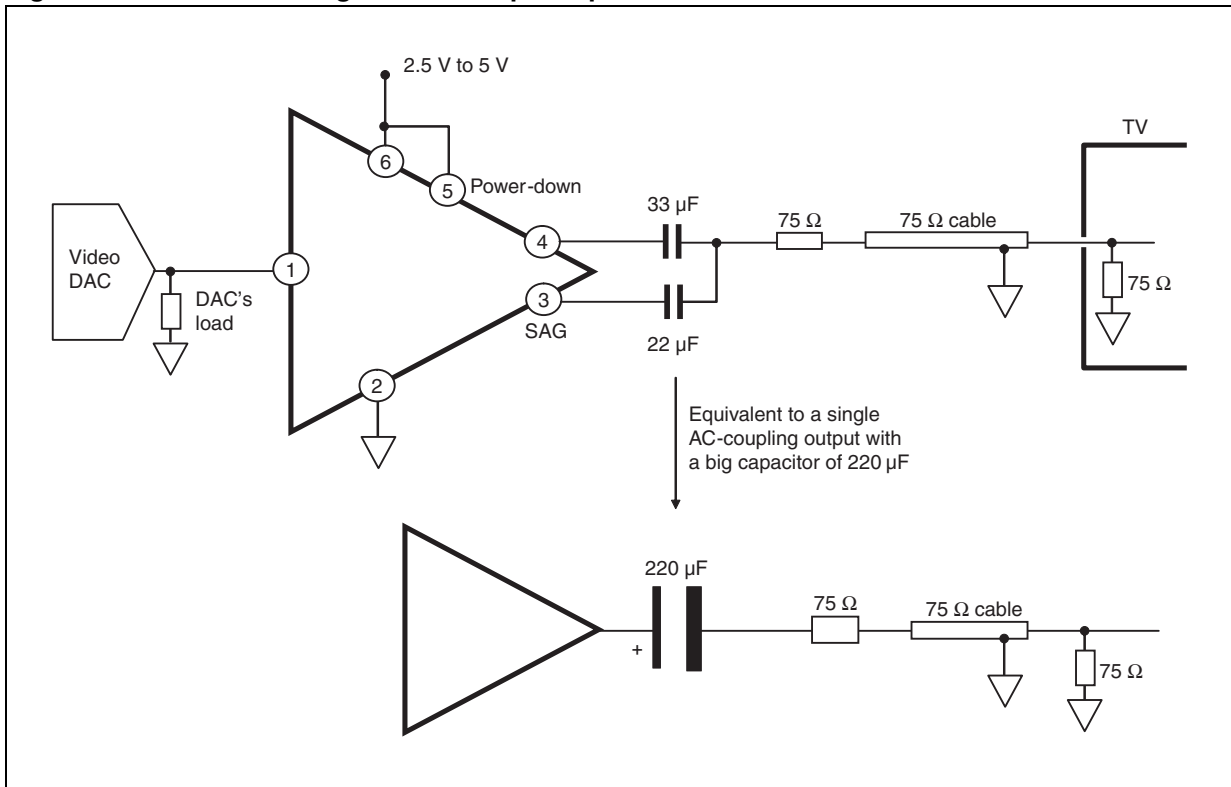
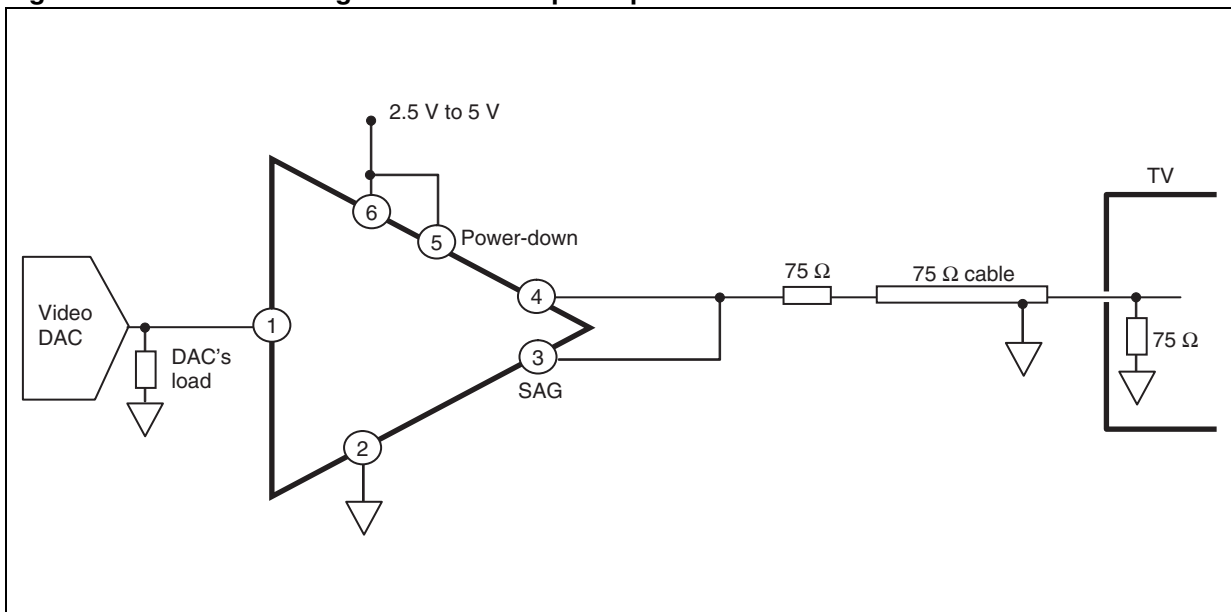
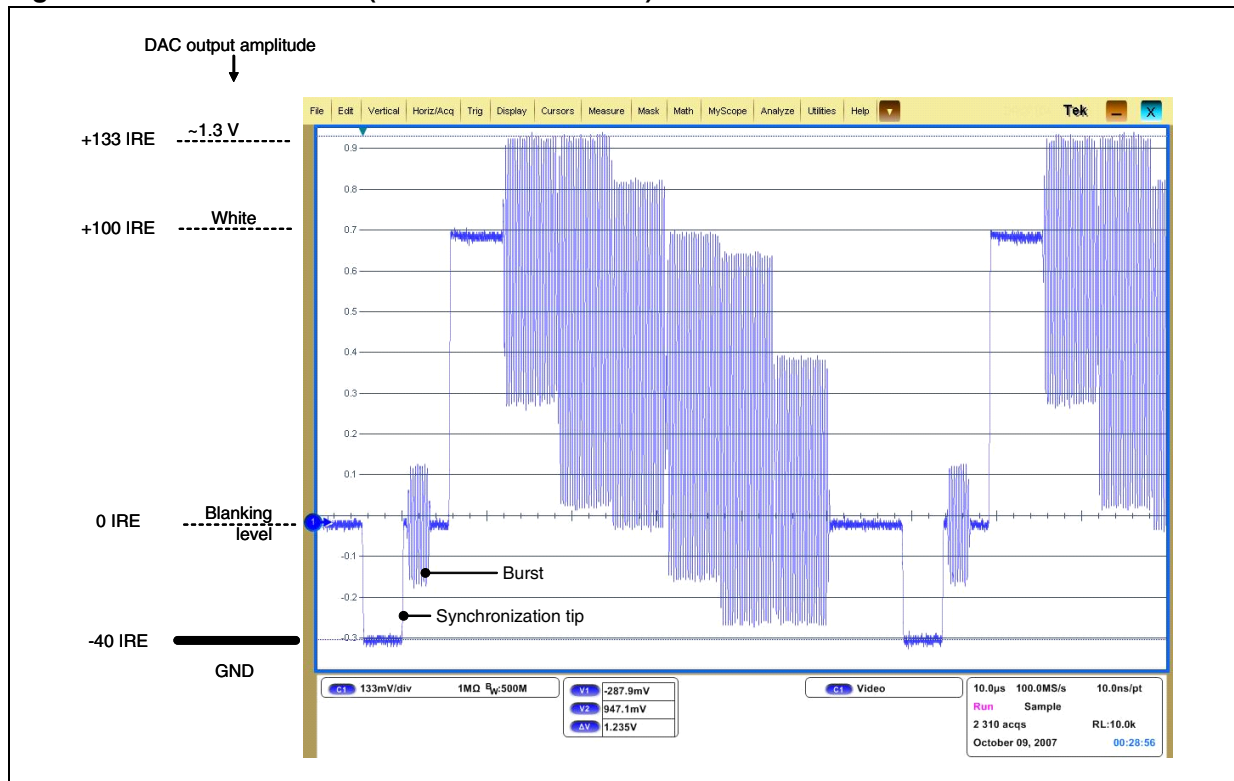

Figure 27. Schematic diagram without output capacitor



3.3 Using the TSH122 to drive a Cvbs signal

Figure 28. Details on Cvbs (NTSC color bar 100%)



With its internal DC shift, the TSH122 can drive a video signal from the DAC output as low as 0 V (bottom of the synchronization tip at 0 V - see [Figure 14](#)).

4 Package information

In order to meet environmental requirements, STMicroelectronics offers these devices in ECOPACK[®] packages. These packages have a lead-free second level interconnect. The category of second level interconnect is marked on the package and on the inner box label, in compliance with JEDEC Standard JESD97. The maximum ratings related to soldering conditions are also marked on the inner box label. ECOPACK is an STMicroelectronics trademark. ECOPACK specifications are available at: www.st.com.

Figure 29. SC70-6 (or SOT323-6) package footprint (in millimeters)

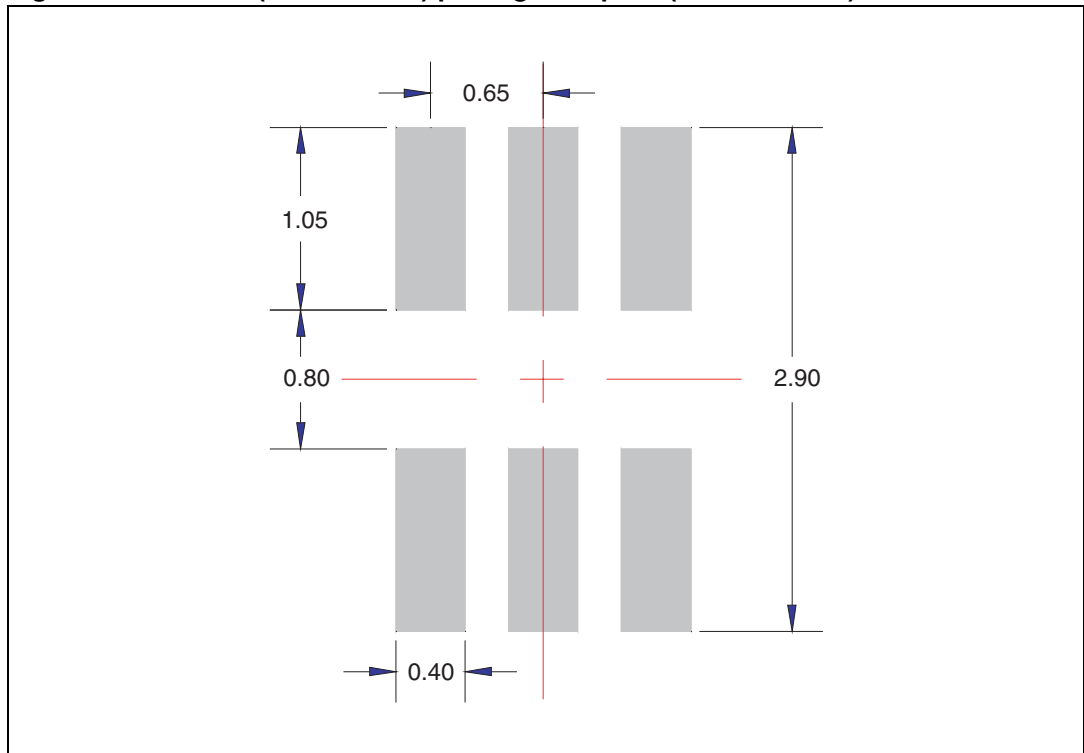
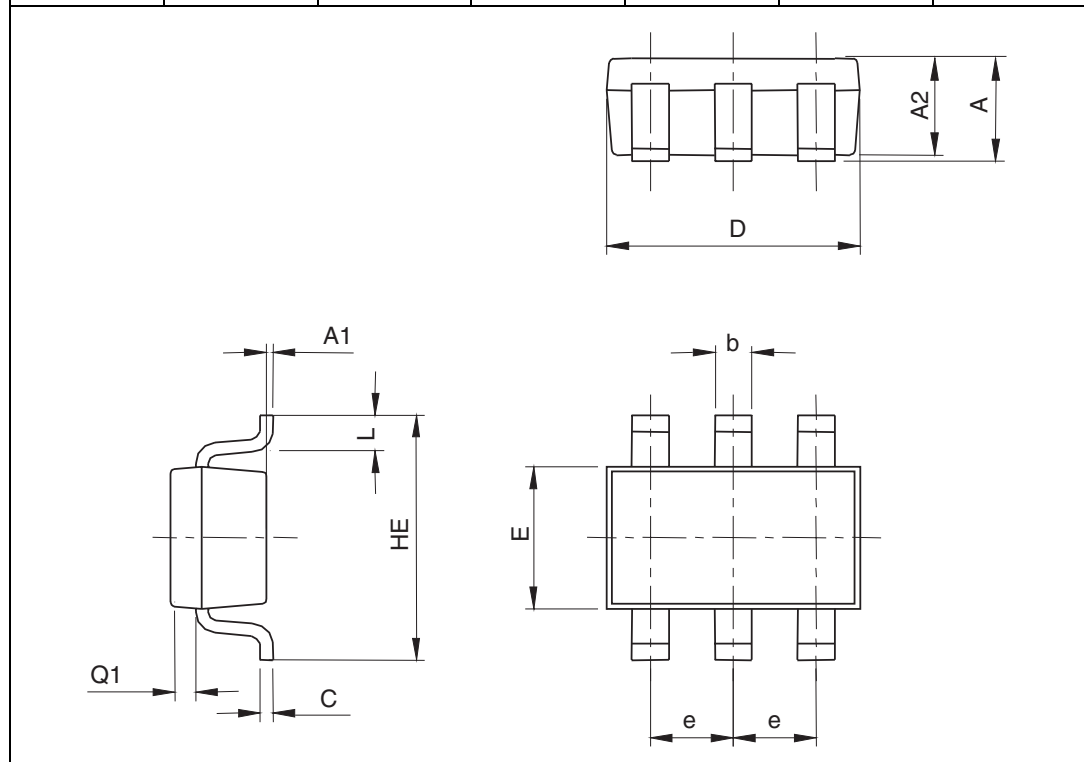

Figure 30. SC70-6 (or SOT323-6) package mechanical data

Ref	Dimensions					
	Millimeters			Mils		
	Min	Typ	Max	Min	Typ	Max
A	0.80		1.10	31.5		43.3
A1	0		0.10	0		3.9
A2	0.80		1.00	31.5		39.3
b	0.15		0.30	5.9		11.8
c	0.10		0.18	3.9		7.0
D	1.80		2.20	70.8		86.6
E	1.15		1.35	45.2		43.1
e		0.65			25.6	
HE	1.8		2.4	70.8		94.5
L	0.10		0.40	3.9		15.7
Q1	0.10		0.40	3.9		15.7



5 Ordering information

Table 4. Order codes

Part number	Temperature range	Package	Packaging	Marking
TSH122ICT	-40°C to +85°C	SC70	Tape & reel	K31

6 Revision history

Table 5. Document revision history

Date	Revision	Changes
04-Aug-2008	1	Initial release.

Please Read Carefully:

Information in this document is provided solely in connection with ST products. STMicroelectronics NV and its subsidiaries ("ST") reserve the right to make changes, corrections, modifications or improvements, to this document, and the products and services described herein at any time, without notice.

All ST products are sold pursuant to ST's terms and conditions of sale.

Purchasers are solely responsible for the choice, selection and use of the ST products and services described herein, and ST assumes no liability whatsoever relating to the choice, selection or use of the ST products and services described herein.

No license, express or implied, by estoppel or otherwise, to any intellectual property rights is granted under this document. If any part of this document refers to any third party products or services it shall not be deemed a license grant by ST for the use of such third party products or services, or any intellectual property contained therein or considered as a warranty covering the use in any manner whatsoever of such third party products or services or any intellectual property contained therein.

UNLESS OTHERWISE SET FORTH IN ST'S TERMS AND CONDITIONS OF SALE ST DISCLAIMS ANY EXPRESS OR IMPLIED WARRANTY WITH RESPECT TO THE USE AND/OR SALE OF ST PRODUCTS INCLUDING WITHOUT LIMITATION IMPLIED WARRANTIES OF MERCHANTABILITY, FITNESS FOR A PARTICULAR PURPOSE (AND THEIR EQUIVALENTS UNDER THE LAWS OF ANY JURISDICTION), OR INFRINGEMENT OF ANY PATENT, COPYRIGHT OR OTHER INTELLECTUAL PROPERTY RIGHT.

UNLESS EXPRESSLY APPROVED IN WRITING BY AN AUTHORIZED ST REPRESENTATIVE, ST PRODUCTS ARE NOT RECOMMENDED, AUTHORIZED OR WARRANTED FOR USE IN MILITARY, AIR CRAFT, SPACE, LIFE SAVING, OR LIFE SUSTAINING APPLICATIONS, NOR IN PRODUCTS OR SYSTEMS WHERE FAILURE OR MALFUNCTION MAY RESULT IN PERSONAL INJURY, DEATH, OR SEVERE PROPERTY OR ENVIRONMENTAL DAMAGE. ST PRODUCTS WHICH ARE NOT SPECIFIED AS "AUTOMOTIVE GRADE" MAY ONLY BE USED IN AUTOMOTIVE APPLICATIONS AT USER'S OWN RISK.

Resale of ST products with provisions different from the statements and/or technical features set forth in this document shall immediately void any warranty granted by ST for the ST product or service described herein and shall not create or extend in any manner whatsoever, any liability of ST.

ST and the ST logo are trademarks or registered trademarks of ST in various countries.

Information in this document supersedes and replaces all information previously supplied.

The ST logo is a registered trademark of STMicroelectronics. All other names are the property of their respective owners.

© 2008 STMicroelectronics - All rights reserved

STMicroelectronics group of companies

Australia - Belgium - Brazil - Canada - China - Czech Republic - Finland - France - Germany - Hong Kong - India - Israel - Italy - Japan - Malaysia - Malta - Morocco - Singapore - Spain - Sweden - Switzerland - United Kingdom - United States of America

www.st.com

Компания «Океан Электроники» предлагает заключение долгосрочных отношений при поставках импортных электронных компонентов на взаимовыгодных условиях!

Наши преимущества:

- Поставка оригинальных импортных электронных компонентов напрямую с производств Америки, Европы и Азии, а так же с крупнейших складов мира;
- Широкая линейка поставок активных и пассивных импортных электронных компонентов (более 30 млн. наименований);
- Поставка сложных, дефицитных, либо снятых с производства позиций;
- Оперативные сроки поставки под заказ (от 5 рабочих дней);
- Экспресс доставка в любую точку России;
- Помощь Конструкторского Отдела и консультации квалифицированных инженеров;
- Техническая поддержка проекта, помощь в подборе аналогов, поставка прототипов;
- Поставка электронных компонентов под контролем ВП;
- Система менеджмента качества сертифицирована по Международному стандарту ISO 9001;
- При необходимости вся продукция военного и аэрокосмического назначения проходит испытания и сертификацию в лаборатории (по согласованию с заказчиком);
- Поставка специализированных компонентов военного и аэрокосмического уровня качества (Xilinx, Altera, Analog Devices, Intersil, Interpoint, Microsemi, Actel, Aeroflex, Peregrine, VPT, Syfer, Eurofarad, Texas Instruments, MS Kennedy, Miteq, Cobham, E2V, MA-COM, Hittite, Mini-Circuits, General Dynamics и др.);

Компания «Океан Электроники» является официальным дистрибьютором и эксклюзивным представителем в России одного из крупнейших производителей разъемов военного и аэрокосмического назначения «JONHON», а так же официальным дистрибьютором и эксклюзивным представителем в России производителя высокотехнологичных и надежных решений для передачи СВЧ сигналов «FORSTAR».



JONHON

«JONHON» (основан в 1970 г.)

Разъемы специального, военного и аэрокосмического назначения:

(Применяются в военной, авиационной, аэрокосмической, морской, железнодорожной, горно- и нефтедобывающей отраслях промышленности)

«FORSTAR» (основан в 1998 г.)

ВЧ соединители, коаксиальные кабели, кабельные сборки и микроволновые компоненты:

(Применяются в телекоммуникациях гражданского и специального назначения, в средствах связи, РЛС, а так же военной, авиационной и аэрокосмической отраслях промышленности).



Телефон: 8 (812) 309-75-97 (многоканальный)

Факс: 8 (812) 320-03-32

Электронная почта: ocean@oceanchips.ru

Web: <http://oceanchips.ru/>

Адрес: 198099, г. Санкт-Петербург, ул. Калинина, д. 2, корп. 4, лит. А