

ABSOLUTE MAXIMUM RATINGS

(Note 1)

Supply Voltage (V_{CC1} , V_{CC2} , $IF+$, $IF-$).....	5.5V
Enable Voltage	-0.3V to $V_{CC} + 0.3V$
LO Input Power (380MHz to 4GHz).....	10dBm
LO Input DC Voltage	-1V to $V_{CC} + 1V$
Continuous RF Input Power (400MHz to 4GHz)	12dBm
RF Input Power (400MHz to 4GHz).....	15dBm
RF Input DC Voltage.....	$\pm 0.1V$
Operating Temperature Range	-40°C to 85°C
Storage Temperature Range.....	-65°C to 125°C
Junction Temperature (T_J)	125°C

PIN CONFIGURATION

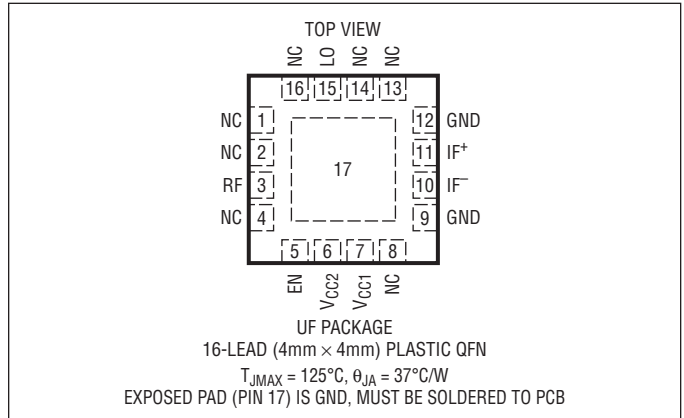

ORDER INFORMATION

LEAD FREE FINISH	TAPE AND REEL	PART MARKING	PACKAGE DESCRIPTION	TEMPERATURE RANGE
LT5527EUF#PBF	LT5527EUF#TRPBF	5527	16-Lead (4mm × 4mm) Plastic QFN	-40°C to 85°C

Consult LTC Marketing for parts specified with wider operating temperature ranges.

Consult LTC Marketing for information on non-standard lead based finish parts.

For more information on lead free part marking, go to: <http://www.linear.com/leadfree/>

For more information on tape and reel specifications, go to: <http://www.linear.com/tapeandreel/>

DC ELECTRICAL CHARACTERISTICS

$V_{CC} = 5V$, $EN = High$, $T_A = 25^{\circ}C$, unless otherwise specified. Test circuit shown in Figure 1. (Note 3)

PARAMETER	CONDITIONS	MIN	TYP	MAX	UNITS
Power Supply Requirements (V_{CC})					
Supply Voltage		4.5	5	5.25	VDC
Supply Current	V_{CC1} (Pin 7)		23.2		mA
	V_{CC2} (Pin 6)		2.8		mA
	$IF+ + IF-$ (Pin 11 + Pin 10)		52	60	mA
	Total Supply Current		78	88	mA
Enable (EN) Low = Off, High = On					
Shutdown Current	$EN = Low$			100	μA
Input High Voltage (On)		3			VDC
Input Low Voltage (Off)				0.3	VDC
EN Pin Input Current	$EN = 5VDC$		50	90	μA
Turn-ON Time			3		μs
Turn-OFF Time			3		μs

AC ELECTRICAL CHARACTERISTICS

Test circuit shown in Figure 1. (Notes 2, 3)

PARAMETER	CONDITIONS	MIN	TYP	MAX	UNITS
RF Input Frequency Range	No External Matching (Midband)		1700 to 3000		MHz
	With External Matching (Low Band or High Band)	400		3700	MHz
LO Input Frequency Range	No External Matching		1200 to 3500		MHz
	With External Matching	380			MHz
IF Output Frequency Range	Requires Appropriate IF Matching		0.1 to 600		MHz

5527fa

AC ELECTRICAL CHARACTERISTICS Test circuit shown in Figure 1. (Notes 2, 3)

PARAMETER	CONDITIONS	MIN	TYP	MAX	UNITS
RF Input Return Loss	$Z_0 = 50\Omega$, 1700MHz to 3000MHz		>10		dB
LO Input Return Loss	$Z_0 = 50\Omega$, 1200MHz to 3400MHz		>12		dB
IF Output Impedance	Differential at 240MHz		407 Ω 2.5pF		R C
LO Input Power	1200MHz to 3500MHz	-8	-3	2	dBm
	380MHz to 1200MHz	-5	0	5	dBm

Standard Downmixer Application: $V_{CC} = 5V$, EN = High, $T_A = 25^\circ C$, $P_{RF} = -5dBm$ (-5dBm/tone for 2-tone IIP3 tests, $\Delta f = 1MHz$), $f_{LO} = f_{RF} - f_{IF}$, $P_{LO} = -3dBm$ (0dBm for 450MHz and 900MHz tests), IF output measured at 240MHz, unless otherwise noted. Test circuit shown in Figure 1. (Notes 2, 3, 4)

PARAMETER	CONDITIONS	MIN	TYP	MAX	UNITS
Conversion Gain	RF = 450MHz, IF = 140MHz, High Side LO		2.5		dB
	RF = 900MHz, IF = 140MHz		3.4		dB
	RF = 1700MHz		2.3		dB
	RF = 1900MHz		2.3		dB
	RF = 2200MHz		2.0		dB
	RF = 2650MHz		1.8		dB
	RF = 3500MHz, IF = 380MHz		0.3		dB
Conversion Gain vs Temperature	$T_A = -40^\circ C$ to $85^\circ C$, RF = 1900MHz		-0.018		dB/ $^\circ C$
Input 3rd Order Intercept	RF = 450MHz, IF = 140MHz, High Side LO		23.2		dBm
	RF = 900MHz, IF = 140MHz		24.5		dBm
	RF = 1700MHz		24.2		dBm
	RF = 1900MHz		23.5		dBm
	RF = 2200MHz		22.7		dBm
	RF = 2650MHz		20.8		dBm
	RF = 3500MHz, IF = 380MHz		18.2		dBm
Single-Sideband Noise Figure	RF = 450MHz, IF = 140MHz, High Side LO		13.3		dB
	RF = 900MHz, IF = 140MHz		11.6		dB
	RF = 1700MHz		12.1		dB
	RF = 1900MHz		12.5		dB
	RF = 2200MHz		13.2		dB
	RF = 2650MHz		13.9		dB
	RF = 3500MHz, IF = 380MHz		16.1		dB
LO to RF Leakage	$f_{LO} = 400MHz$ to 2100MHz		≤ -44		dBm
	$f_{LO} = 2100MHz$ to 3200MHz		≤ -36		dBm
LO to IF Leakage	$f_{LO} = 400MHz$ to 700MHz		≤ -40		dBm
	$f_{LO} = 700MHz$ to 3200MHz		≤ -50		dBm
RF to LO Isolation	$f_{RF} = 400MHz$ to 2200MHz		>43		dB
	$f_{RF} = 2200MHz$ to 3700MHz		>38		dB
RF to IF Isolation	$f_{RF} = 400MHz$ to 800MHz		>42		dB
	$f_{RF} = 800MHz$ to 3700MHz		>54		dB
2RF-2LO Output Spurious Product ($f_{RF} = f_{LO} + f_{IF}/2$)	900MHz: $f_{RF} = 830MHz$ at -5dBm, $f_{IF} = 140MHz$		-60		dBc
	1900MHz: $f_{RF} = 1780MHz$ at -5dBm, $f_{IF} = 240MHz$		-65		dBc
3RF-3LO Output Spurious Product ($f_{RF} = f_{LO} + f_{IF}/3$)	900MHz: $f_{RF} = 806.67MHz$ at -5dBm, $f_{IF} = 140MHz$		-73		dBc
	1900MHz: $f_{RF} = 1740MHz$ at -5dBm, $f_{IF} = 240MHz$		-63		dBc
Input 1dB Compression	RF = 450MHz, IF = 140MHz, High Side		9.5		dBm
	LO RF = 900MHz, IF = 140MHz		8.9		dBm
	RF = 1900MHz		9.0		dBm

Note 1: Stresses beyond those listed under Absolute Maximum Ratings may cause permanent damage to the device. Exposure to any Absolute Maximum Rating condition for extended periods may affect device reliability and lifetime.

Note 2: 450MHz, 900MHz and 3500MHz performance measured with external LO and RF matching. See Figure 1 and Applications Information.

Note 3: Specifications over the $-40^\circ C$ to $85^\circ C$ temperature range are assured by design, characterization and correlation with statistical process controls.

Note 4: SSB Noise Figure measurements performed with a small-signal noise source and bandpass filter on RF input, and no other RF signal applied.

TYPICAL AC PERFORMANCE CHARACTERISTICS Midband (No external RF/LO matching)

$V_{CC} = 5V$, EN = High, $P_{RF} = -5dBm$ ($-5dBm/$ tone for 2-tone IIP3 tests, $\Delta f = 1MHz$), $P_{LO} = -3dBm$, IF output measured at 240MHz, unless otherwise noted. Test circuit shown in Figure 1.

Conversion Gain, IIP3 and NF vs RF Frequency

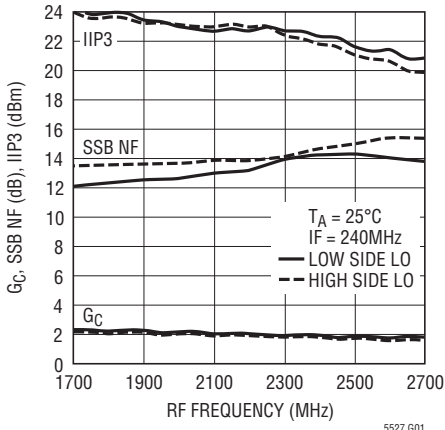

5527 G01

LO Leakage vs LO Frequency

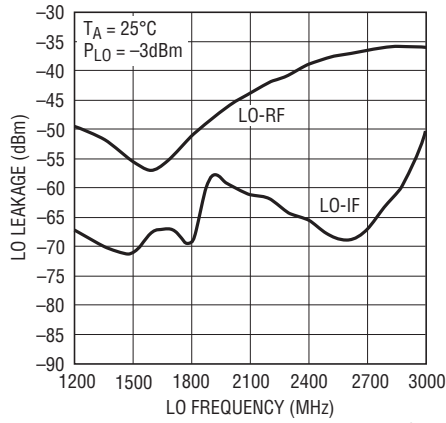

5527 G02

RF Isolation vs RF Frequency

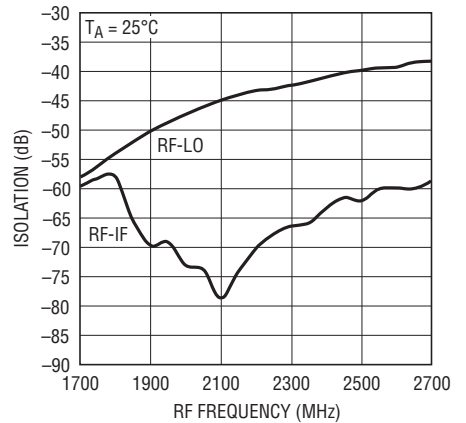

5527 G03

Conversion Gain and IIP3 vs Temperature (Low Side LO)

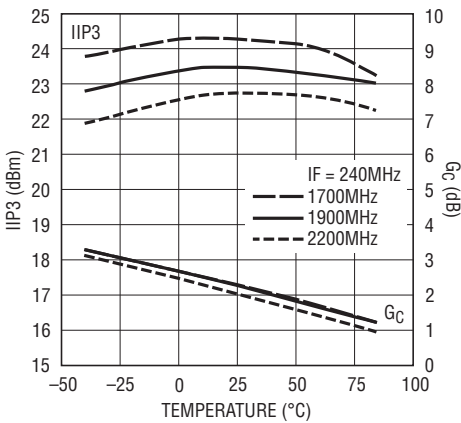

5527 G04

Conversion Gain and IIP3 vs Temperature (High Side LO)

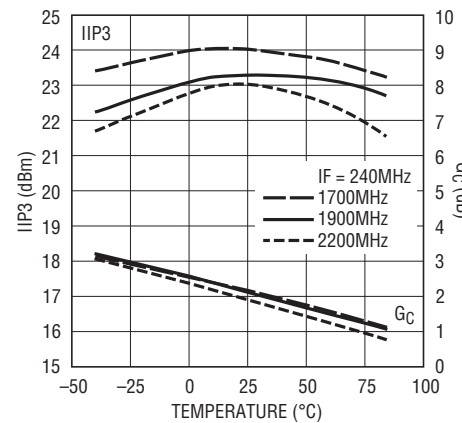

5527 G05

1900MHz Conversion Gain, IIP3 and NF vs Supply Voltage

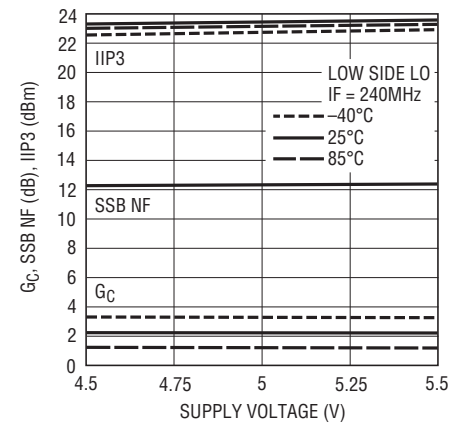

5527 G06

1700MHz Conversion Gain, IIP3 and NF vs LO Power

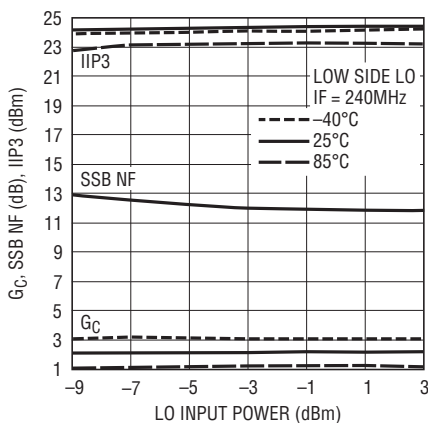

5527 G07

1900MHz Conversion Gain, IIP3 and NF vs LO Power

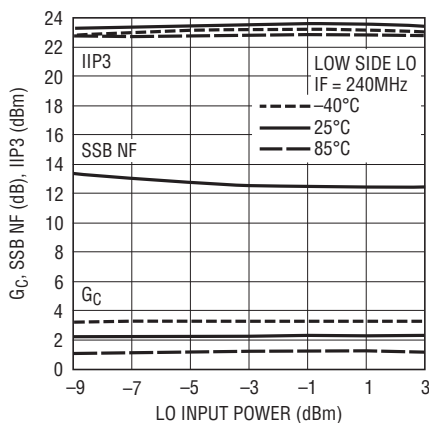

5527 G08

2200MHz Conversion Gain, IIP3 and NF vs LO Power

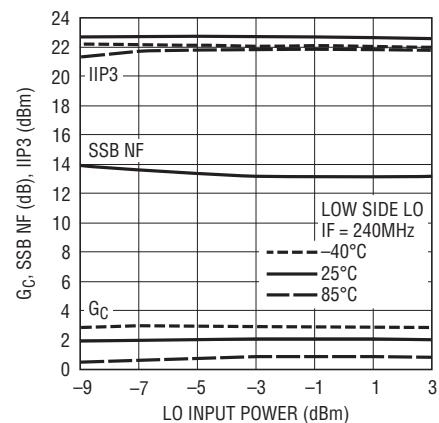

5527 G09

TYPICAL AC PERFORMANCE CHARACTERISTICS

Midband (No external RF/LO matching)

$V_{CC} = 5V$, EN = High, $P_{RF} = -5dBm$ (-5dBm/tone for 2-tone IIP3 tests, $\Delta f = 1MHz$), $P_{LO} = -3dBm$, IF output measured at 240MHz, unless otherwise noted. Test circuit shown in Figure 1.

IF Output Power, IM3 and IM5 vs RF Input Power (2 Input Tones)

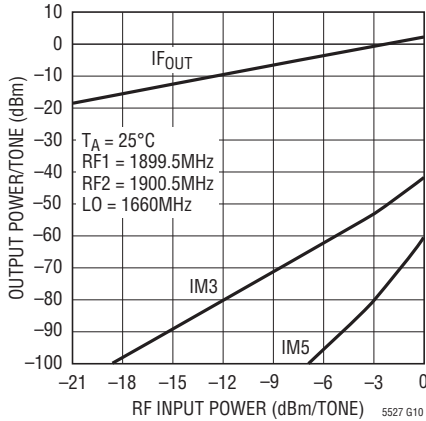

I_{FOUT} , 2 × 2 and 3 × 3 Spurs vs RF Input Power (Single Tone)

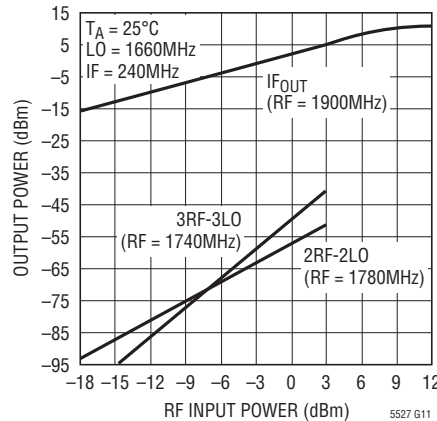

2 × 2 and 3 × 3 Spurs vs LO Power (Single Tone)

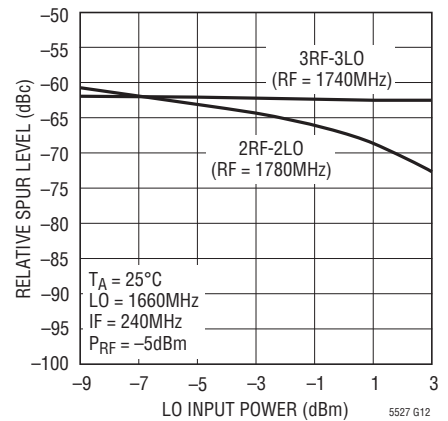

High Band (3500MHz application with external RF matching) $V_{CC} = 5V$, EN = High, $P_{RF} = -5dBm$ (-5dBm/tone for 2-tone IIP3 tests, $\Delta f = 1MHz$), low side LO, $P_{LO} = -3dBm$, IF output measured at 380MHz, unless otherwise noted. Test circuit shown in Figure 1.

Conversion Gain, IIP3 and SSB NF vs RF Frequency

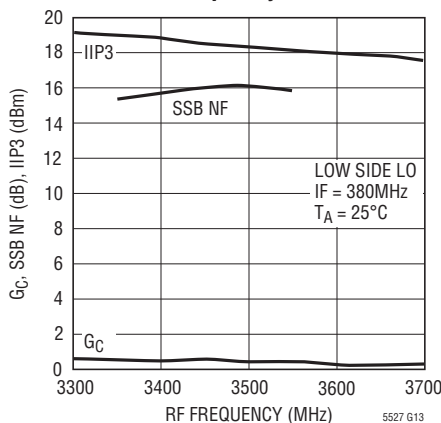

3500MHz Conversion Gain, IIP3 and SSB NF vs LO Power

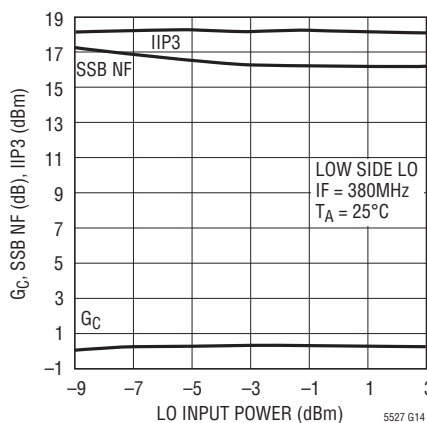

LO Leakage and RF-LO Isolation vs LO and RF Frequency

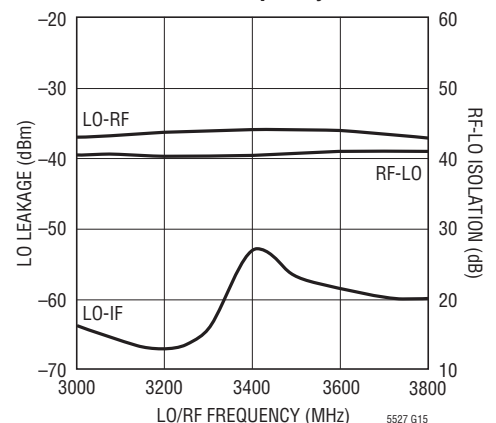

Low Band (450MHz application with external RF/LO matching) $V_{CC} = 5V$, EN = High, $P_{RF} = -5dBm$ (-5dBm/tone for 2-tone IIP3 tests, $\Delta f = 1MHz$), $P_{LO} = 0dBm$, IF output measured at 140MHz, unless otherwise noted. Test circuit shown in Figure 1.

Conversion Gain, IIP3 and NF vs RF Frequency

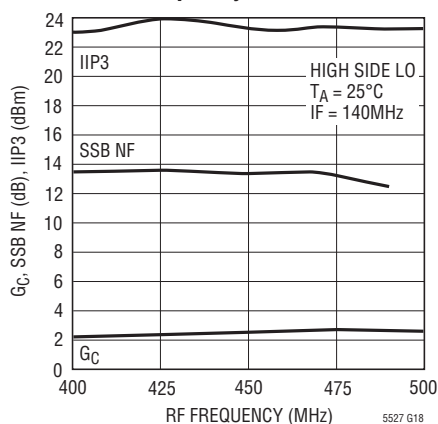

450MHz Conversion Gain, IIP3 and NF vs LO Power

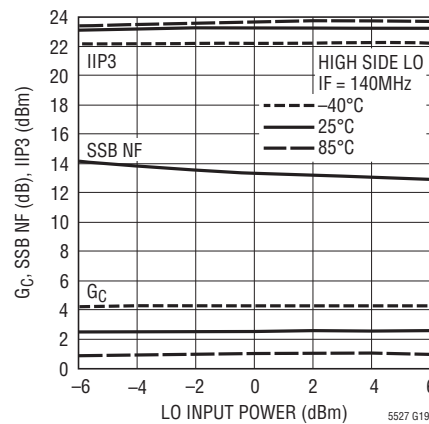

LO Leakage vs LO Frequency

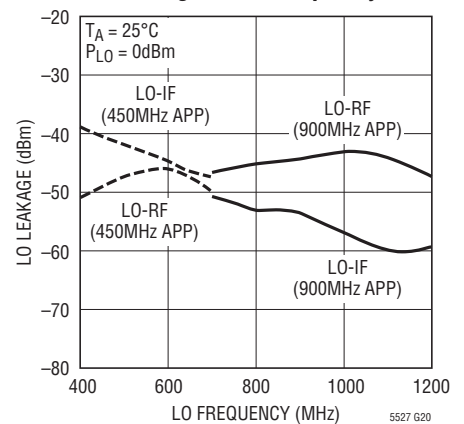

TYPICAL AC PERFORMANCE CHARACTERISTICS Low Band (900MHz application with external RF/LO matching) $V_{CC} = 5V$, EN = High, $P_{RF} = -5dBm$ (-5dBm/tone for 2-tone IIP3 tests, $\Delta f = 1MHz$), $P_{LO} = 0dBm$, IF output measured at 140MHz, unless otherwise noted. Test circuit shown in Figure 1.

Conversion Gain, IIP3 and NF vs RF Frequency (900MHz Low Side Application)

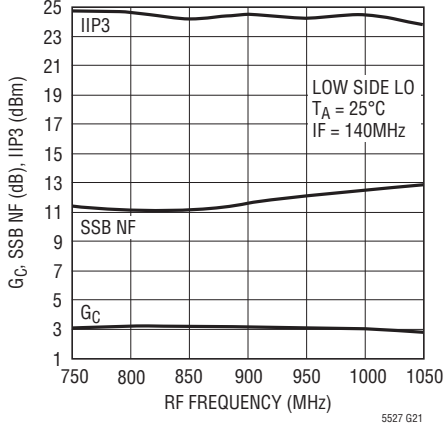

900MHz Conversion Gain, IIP3 and NF vs LO Power (Low Side LO)

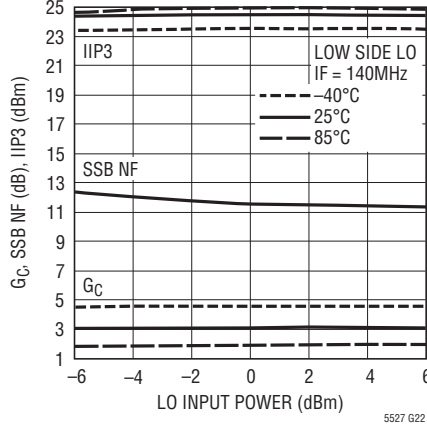

IF_{OUT}, 2 × 2 and 3 × 3 Spurs vs RF Input Power (Single Tone)

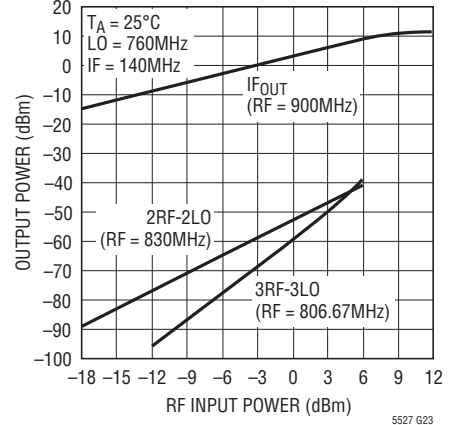

Conversion Gain, IIP3 and NF vs RF Frequency (900MHz High Side Application)

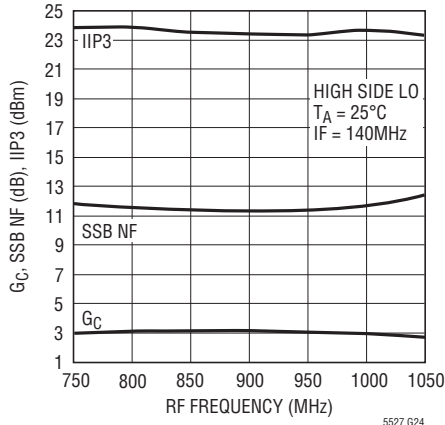

900MHz Conversion Gain, IIP3 and NF vs LO Power (High Side LO)

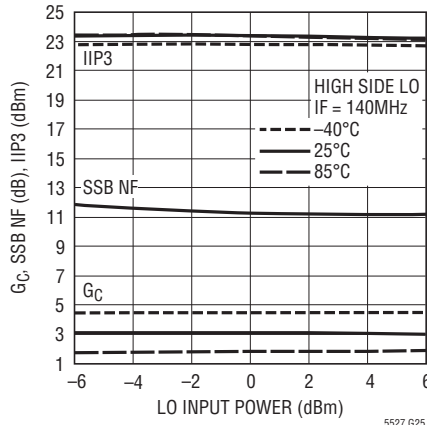

2 × 2 and 3 × 3 Spurs vs LO Power (Single Tone)

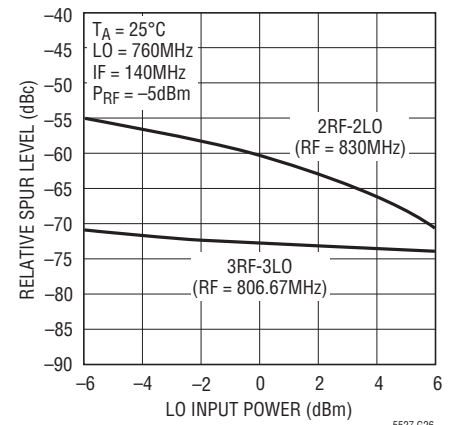

TYPICAL DC PERFORMANCE CHARACTERISTICS Test circuit shown in Figure 1.

Supply Current vs Supply Voltage

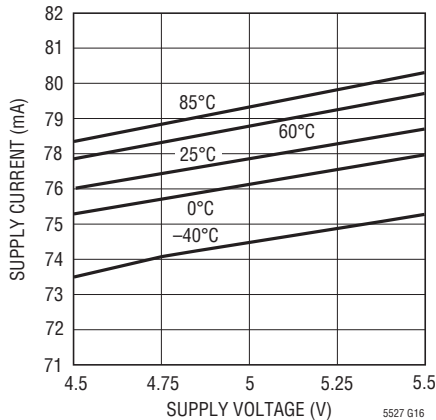

Shutdown Current vs Supply Voltage

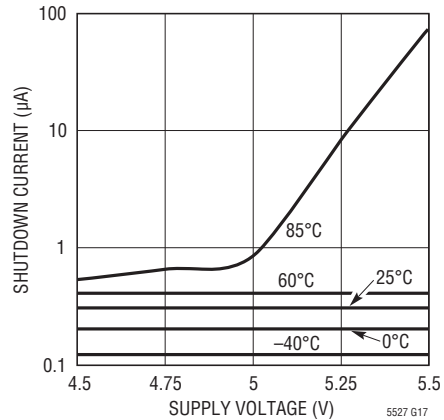

PIN FUNCTIONS

NC (Pins 1, 2, 4, 8, 13, 14, 16): Not Connected Internally. These pins should be grounded on the circuit board for improved LO-to-RF and LO-to-IF isolation.

RF (Pin 3): Single-Ended Input for the RF Signal. This pin is internally connected to the primary side of the RF input transformer, which has low DC resistance to ground. **If the RF source is not DC blocked, then a series blocking capacitor must be used.** The RF input is internally matched from 1.7GHz to 3GHz. Operation down to 400MHz or up to 3700MHz is possible with simple external matching.

EN (Pin 5): Enable Pin. When the input enable voltage is higher than 3V, the mixer circuits supplied through Pins 6, 7, 10 and 11 are enabled. When the input voltage is less than 0.3V, all circuits are disabled. Typical input current is 50μA for EN = 5V and 0μA when EN = 0V. The EN pin should not be left floating. Under no conditions should the EN pin voltage exceed $V_{CC} + 0.3V$, even at start-up.

V_{CC2} (Pin 6): Power Supply Pin for the Bias Circuits. Typical current consumption is 2.8mA. This pin should be externally connected to the V_{CC1} pin and decoupled with 1000pF and 1μF capacitors.

V_{CC1} (Pin 7): Power Supply Pin for the LO Buffer Circuits. Typical current consumption is 23.2mA. This pin should

be externally connected to the V_{CC2} pin and decoupled with 1000pF and 1μF capacitors.

GND (Pins 9, 12): Ground. These pins are internally connected to the backside ground for improved isolation. They should be connected to the RF ground on the circuit board, although they are not intended to replace the primary grounding through the backside contact of the package.

IF⁻, IF⁺ (Pins 10, 11): Differential Outputs for the IF Signal. An impedance transformation may be required to match the outputs. These pins must be connected to V_{CC} through impedance matching inductors, RF chokes or a transformer center tap.

LO (Pin 15): Single-Ended Input for the Local Oscillator Signal. This pin is internally connected to the primary side of the LO transformer, which is internally DC blocked. An external blocking capacitor is not required. The LO input is internally matched from 1.2GHz to 5GHz. Operation down to 380MHz is possible with simple external matching.

Exposed Pad (Pin 17): Circuit Ground Return for the Entire IC. This must be soldered to the printed circuit board ground plane.

BLOCK DIAGRAM

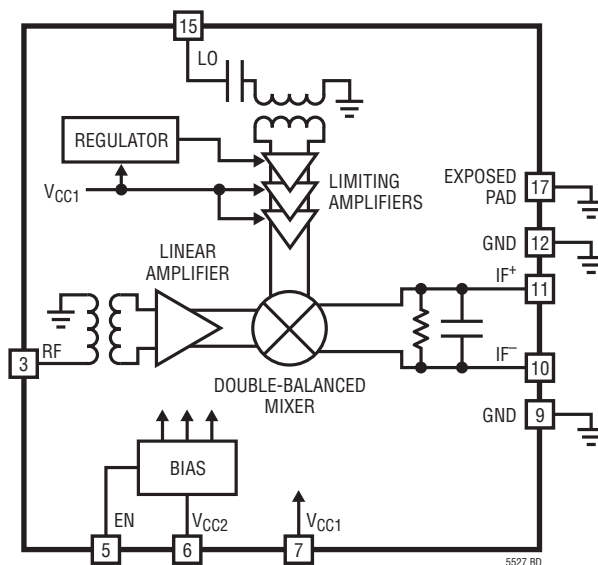

TEST CIRCUITS

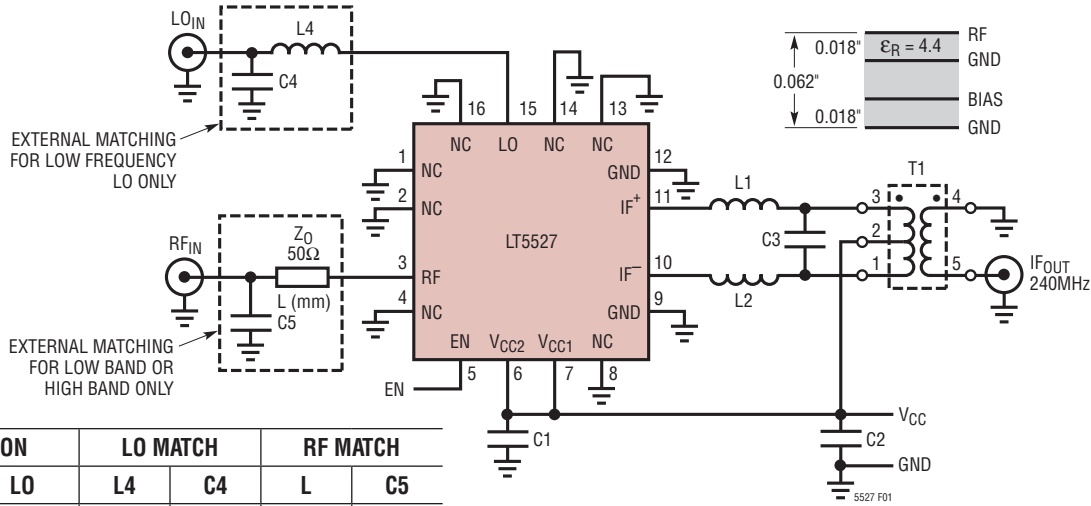

APPLICATION		LO MATCH		RF MATCH	
RF	LO	L4	C4	L	C5
450MHz	High Side	6.8nH	10pF	4.5mm	12pF
900MHz	Low Side	3.9nH	5.6pF	1.3mm	3.9pF
900MHz	High Side	—	2.7pF	1.3mm	3.9pF
3500MHz	Low Side	—	—	4.5mm	0.5pF

REF DES	VALUE	SIZE	PART NUMBER	REF DES	VALUE	SIZE	PART NUMBER
C1	1000pF	0402	AVX 04025C102JAT	L4, C4, C5		0402	See Applications Information
C2	1μF	0603	AVX 0603ZD105KAT	L1, L2	82nH	0603	Toko LLQ1608-A82N
C3	2.7pF	0402	AVX 04025A2R7CAT	T1	4:1		M/A-Com ETC4-1-2 (2MHz to 800MHz)

Figure 1. Downmixer Test Schematic—Standard IF Matching (240MHz IF)

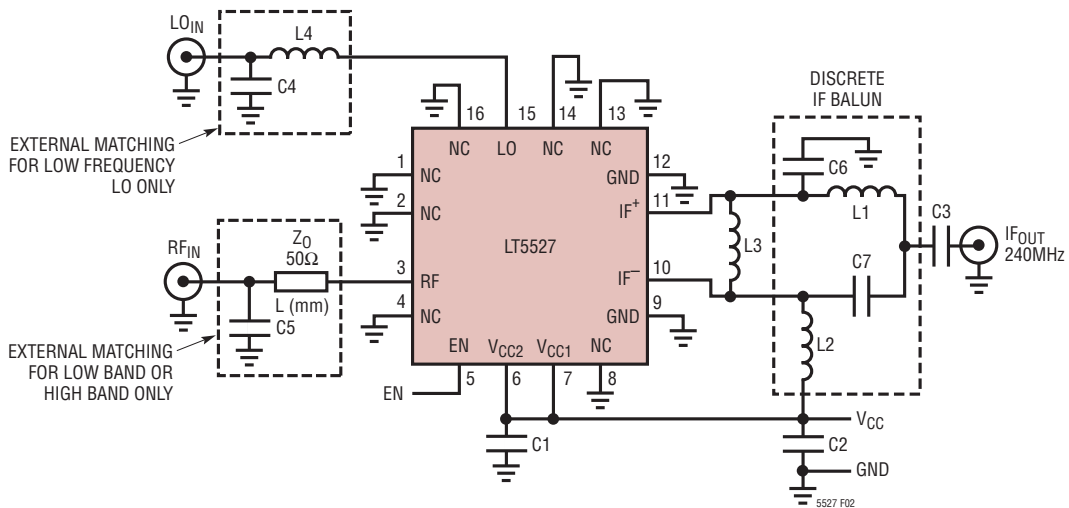

REF DES	VALUE	SIZE	PART NUMBER	REF DES	VALUE	SIZE	PART NUMBER
C1, C3	1000pF	0402	AVX 04025C102JAT	L4, C4, C5		0402	See Applications Information
C2	1μF	0603	AVX 0603ZD105KAT	L1, L2	100nH	0603	Toko LLQ1608-AR10
C6, C7	4.7pF	0402	AVX 04025A4R7CAT	L3	220nH	0603	Toko LLQ1608-AR22

Figure 2. Downmixer Test Schematic—Discrete IF Balun Matching (240MHz IF)

APPLICATIONS INFORMATION

Introduction

The LT5527 consists of a high linearity double-balanced mixer, RF buffer amplifier, high speed limiting LO buffer amplifier and bias/enable circuits. The RF and LO inputs are both single ended. The IF output is differential. Low side or high side LO injection can be used.

Two evaluation circuits are available. The standard evaluation circuit, shown in Figure 1, incorporates transformer-based IF matching and is intended for applications that require the lowest LO-IF leakage levels and the widest IF bandwidth. The second evaluation circuit, shown in Figure 2, replaces the IF transformer with a discrete IF balun for reduced solution cost and size. The discrete IF balun delivers comparable noise figure and linearity, higher conversion gain, but degraded LO-IF leakage and reduced IF bandwidth.

RF Input Port

The mixer's RF input, shown in Figure 3, consists of an integrated transformer and a high linearity differential amplifier. The primary terminals of the transformer are connected to the RF input pin (Pin 3) and ground. The secondary side of the transformer is internally connected to the amplifier's differential inputs.

One terminal of the transformer's primary is internally grounded. If the RF source has DC voltage present, then a coupling capacitor must be used in series with the RF input pin.

The RF input is internally matched from 1.7GHz to 3GHz, requiring no external components over this frequency range. The input return loss, shown in Figure 4a, is typically 10dB at the band edges. The input match at the lower band edge can be optimized with a series 2.7pF capacitor

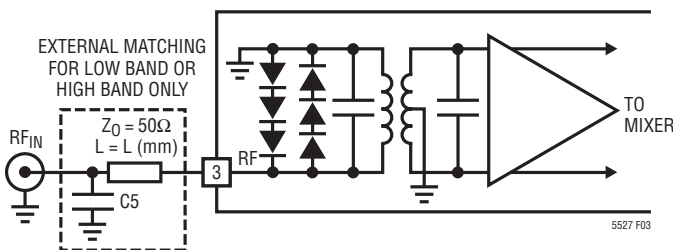
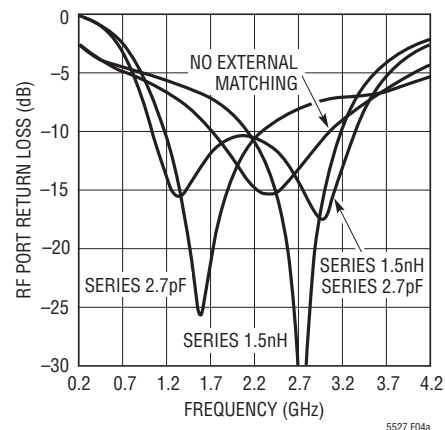

Figure 3. RF Input Schematic

at Pin 3, which improves the 1.7GHz return loss to greater than 20dB. Likewise, the 2.7GHz match can be improved to greater than 30dB with a series 1.5nH inductor. A series 1.5nH/2.7pF network will simultaneously optimize the lower and upper band edges and expand the RF input bandwidth to 1.1GHz-3.3GHz. Measured RF input return losses for these three cases are also plotted in Figure 4a.

Alternatively, the input match can be shifted down, as low as 400MHz or up to 3700MHz, by adding a shunt capacitor (C5) to the RF input. A 450MHz input match is realized with C5 = 12pF, located 4.5mm away from Pin 3 on the evaluation board's 50Ω input transmission line. A 900MHz input match requires C5 = 3.9pF, located at 1.3mm. A 3500MHz input match is realized with C5 = 0.5pF, located at 4.5mm. This



(4a) Series Reactance Matching

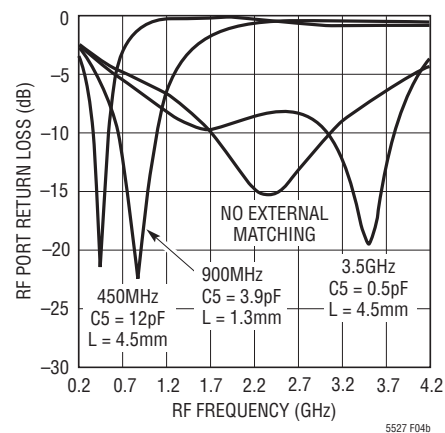

(4b) Series Shunt Matching

Figure 4. RF Input Return Loss With and Without External Matching

APPLICATIONS INFORMATION

series transmission line/shunt capacitor matching topology allows the LT5527 to be used for multiple frequency standards without circuit board layout modifications. The series transmission line can also be replaced with a series chip inductor for a more compact layout.

Input return loss for these three cases (450MHz, 900MHz and 3500MHz) are plotted in Figure 4b. The input return loss with no external matching is repeated in Figure 4b for comparison.

RF input impedance and S11 versus frequency (with no external matching) is listed in Table 1 and referenced to Pin 3. The S11 data can be used with a microwave circuit simulator to design custom matching networks and simulate board-level interfacing to the RF input filter.

Table 1. RF Input Impedance vs Frequency

FREQUENCY (MHz)	INPUT IMPEDANCE	S11	
		MAG	ANGLE
50	4.8 + j2.6	0.825	173.9
300	9.0 + j11.9	0.708	152.5
450	11.9 + j15.3	0.644	144.3
600	14.3 + j18.2	0.600	137.2
900	19.4 + j23.8	0.529	123.2
1200	26.1 + j29.8	0.467	107.4
1500	37.3 + j33.9	0.386	89.3
1850	57.4 + j29.7	0.275	60.6
2150	71.3 + j10.1	0.193	20.6
2450	64.6 - j13.9	0.175	-36.8
2650	53.0 - j21.8	0.209	-70.3
3000	35.0 - j21.2	0.297	-111.2
3500	20.7 - j9.0	0.431	-155.8
4000	14.2 + j6.2	0.564	164.8
5000	10.4 + j31.9	0.745	113.3

LO Input Port

The mixer's LO input, shown in Figure 5, consists of an integrated transformer and high speed limiting differential amplifiers. The amplifiers are designed to precisely drive the mixer for the highest linearity and the lowest noise figure. An internal DC blocking capacitor in series with the transformer's primary eliminates the need for an external blocking capacitor.

The LO input is internally matched from 1.2GHz to 5GHz, although the maximum useful frequency is limited to 3.5GHz by the internal amplifiers. The input match can be shifted down, as low as 750MHz, with a single shunt capacitor (C4) on Pin 15. One example is plotted in Figure 6 where $C4 = 2.7\text{pF}$ produces an 850MHz to 1.2GHz match.

LO input matching below 750MHz requires the series inductor (L4)/shunt capacitor (C4) network shown in Figure 5. Two examples are plotted in Figure 6 where $L4 = 3.9\text{nH}/C4 = 5.6\text{pF}$ produces a 650MHz to 830MHz match and $L4 = 6.8\text{nH}/C4 = 10\text{pF}$ produces a 540MHz to 640MHz match. The evaluation boards do not include pads for L4, so the circuit trace needs to be cut near Pin 15 to insert L4. A low cost multilayer chip inductor is adequate for L4.

The optimum LO drive is -3dBm for LO frequencies above 1.2GHz, although the amplifiers are designed to accommodate several dB of LO input power variation without significant mixer performance variation. Below 1.2GHz,

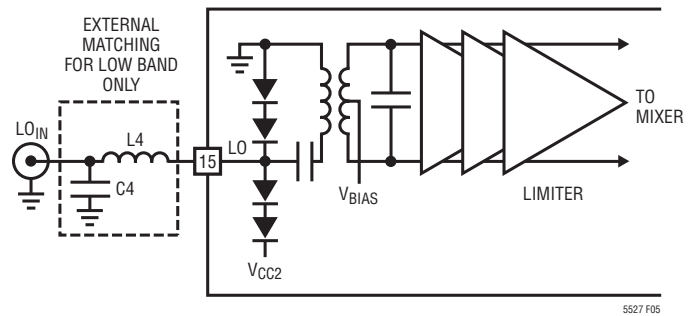

Figure 5. LO Input Schematic

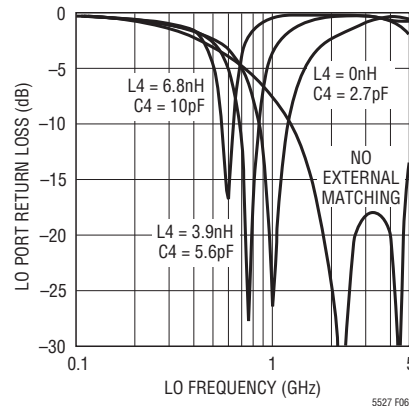

Figure 6. LO Input Return Loss

APPLICATIONS INFORMATION

0dBm LO drive is recommended for optimum noise figure, although -3dBm will still deliver good conversion gain and linearity.

Custom matching networks can be designed using the port impedance data listed in Table 2. This data is referenced to the LO pin with no external matching.

Table 2. LO Input Impedance vs Frequency

FREQUENCY (MHz)	INPUT IMPEDANCE	S11	
		MAG	ANGLE
50	30.4 - j355.7	0.977	-15.9
300	8.7 - j52.2	0.847	-86.7
450	9.4 - j25.4	0.740	-124.8
600	11.5 - j8.9	0.635	-158.7
900	19.7 + j12.8	0.463	146.7
1200	34.3 + j24.3	0.330	106.9
1500	49.8 + j21.3	0.209	78.5
1850	53.8 + j8.9	0.093	61.7
2150	50.4 + j3.2	0.032	80.5
2450	45.1 + j0.3	0.052	176.5
2650	41.1 + j2.4	0.101	163.1
3000	41.9 + j8.1	0.124	129.8
3500	49.0 + j12.0	0.120	87.9
4000	55.4 + j8.6	0.096	53.2
5000	33.2 + j8.7	0.226	146.7

IF Output Port

The IF outputs, IF⁺ and IF⁻, are internally connected to the collectors of the mixer switching transistors (see Figure 7). Both pins must be biased at the supply voltage, which can be applied through the center tap of a transformer or through matching inductors. Each IF pin draws 26mA of supply current (52mA total). For optimum single-ended performance, these differential outputs should be combined externally through an IF transformer or a discrete IF balun circuit. The standard evaluation board (see Figure 1) includes an IF transformer for impedance transformation and differential to single-ended transformation. A second evaluation board (see Figure 2) realizes the same functionality with a discrete IF balun circuit.

The IF output impedance can be modeled as 415Ω in parallel with 2.5pF at low frequencies. An equivalent small-signal model (including bondwire inductance) is shown in Figure

8. Frequency-dependent differential IF output impedance is listed in Table 3. This data is referenced to the package pins (with no external components) and includes the effects of IC and package parasitics. The IF output can be matched for IF frequencies as low as several kHz or as high as 600MHz.

Table 3. IF Output Impedance vs Frequency

FREQUENCY (MHz)	DIFFERENTIAL OUTPUT IMPEDANCE (RIF XIF)
1	415 -j64k
10	415 -j6.4k
70	415 -j909
140	413 -j453
240	407 -j264
300	403 -j211
380	395 -j165
450	387 -j138
500	381 -j124

The following three methods of differential to single-ended IF matching will be described:

- Direct 8:1 transformer
- Lowpass matching + 4:1 transformer
- Discrete IF balun

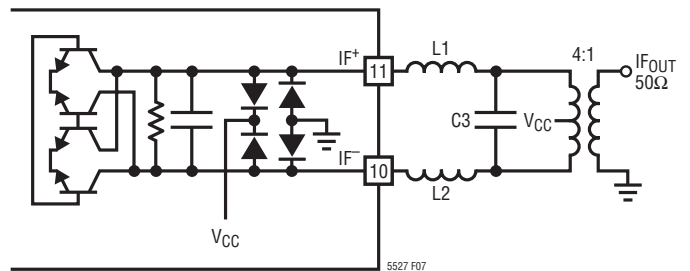

Figure 7. IF Output with External Matching

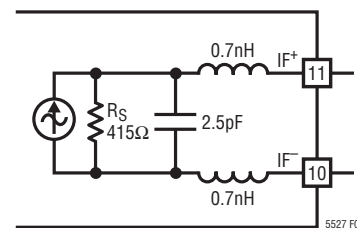

Figure 8. IF Output Small-Signal Model

APPLICATIONS INFORMATION

Direct 8:1 IF Transformer Matching

For IF frequencies below 100MHz, the simplest IF matching technique is an 8:1 transformer connected across the IF pins. The transformer will perform impedance transformation and provide a single-ended 50Ω output. No other matching is required. Measured performance using this technique is shown in Figure 9. This matching is easily implemented on the standard evaluation board by shorting across the pads for L1 and L2 and replacing the 4:1 transformer with an 8:1 (C3 not installed).

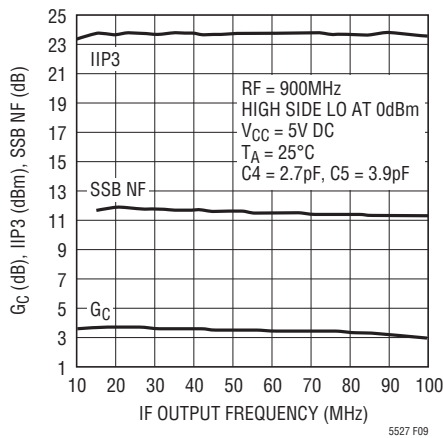

Figure 9. Typical Conversion Gain, IIP3 and SSB NF Using an 8:1 IF Transformer

Lowpass + 4:1 IF Transformer Matching

The lowest LO-IF leakage and wide IF bandwidth are realized by using the simple, three element lowpass matching network shown in Figure 7. Matching elements C3, L1 and L2, in conjunction with the internal 2.5pF capacitance, form a 400Ω to 200Ω lowpass matching network which is tuned to the desired IF frequency. The 4:1 transformer then transforms the 200Ω differential output to a 50Ω single-ended output.

This matching network is most suitable for IF frequencies above 40MHz or so. Below 40MHz, the value of the series inductors (L1 and L2) becomes unreasonably high, and could cause stability problems, depending on the inductor value and parasitics. Therefore, the 8:1 transformer technique is recommended for low IF frequencies.

Suggested lowpass matching element values for several IF

frequencies are listed in Table 4. High-Q wire-wound chip inductors (L1 and L2) improve the mixer's conversion gain by a few tenths of a dB, but have little effect on linearity. Measured output return losses for each case are plotted in Figure 10 for the simple 8:1 transformer method and for the lowpass/4:1 transformer method.

Table 4. IF Matching Element Values

PLOT	IF FREQUENCY (MHz)	L1, L2 (nH)	C3 (pF)	IF TRANSFORMER
1	1 to 100	Short	—	TC8-1 (8:1)
2	140	120	—	ETC4-1-2 (4:1)
3	190	110	2.7	ETC4-1-2 (4:1)
4	240	82	2.7	ETC4-1-2 (4:1)
5	380	56	2.2	ETC4-1-2 (4:1)
6	450	43	2.2	ETC4-1-2 (4:1)

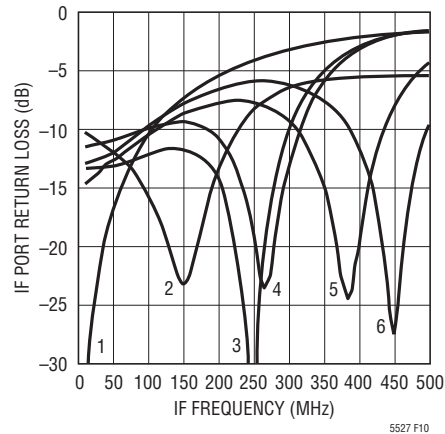

Figure 10. IF Output Return Losses with Lowpass/Transformer Matching

Discrete IF Balun Matching

For many applications, it is possible to replace the IF transformer with the discrete IF balun shown in Figure 2. The values of L1, L2, C6 and C7 are calculated to realize a 180 degree phase shift at the desired IF frequency and provide a 50Ω single-ended output, using the equations listed below. Inductor L3 is calculated to cancel the internal 2.5pF capacitance. L3 also supplies bias voltage to the IF+ pin. Low cost multilayer chip inductors are adequate for L1 and L2. A high Q wire-wound chip inductor is recommended for L3 to maximize conversion gain and minimize DC voltage drop to the IF+ pin. C3 is a DC blocking capacitor.

APPLICATIONS INFORMATION

$$L1, L2 = \frac{\sqrt{R_{IF} \cdot R_{OUT}}}{\omega_{IF}}$$

$$C6, C7 = \frac{1}{\omega_{IF} \cdot \sqrt{R_{IF} \cdot R_{OUT}}}$$

$$L3 = \frac{|X_{IF}|}{\omega_{IF}}$$

Compared to the lowpass/4:1 transformer matching technique, this network delivers approximately 0.8dB higher conversion gain (since the IF transformer loss is eliminated) and comparable noise figure and IIP3. At a $\pm 15\%$ offset from the IF center frequency, conversion gain and noise figure degrade about 1dB. Beyond $\pm 15\%$, conversion gain decreases gradually but noise figure increases rapidly. IIP3 is less sensitive to bandwidth. Other than IF bandwidth, the most significant difference is LO-IF leakage, which degrades to approximately -38dBm compared to the superior performance realized with the lowpass/4:1 transformer matching.

Discrete IF balun element values for four common IF frequencies are listed in Table 5. The corresponding measured IF output return losses are shown in Figure 11. The values listed in Table 5 differ from the calculated values slightly due to circuit board and component parasitics. Typical conversion gain, IIP3 and LO-IF leakage, versus RF input frequency, for all four IF frequency examples is shown in Figure 12. Typical conversion gain, IIP3 and noise figure versus IF output frequency for the same circuits are shown in Figure 13.

Table 5. Discrete IF Balun Element Values ($R_{OUT} = 50\Omega$)

IF FREQUENCY (MHz)	L1, L2 (nH)	C6, C7 (pF)	L3 (nH)
190	120	6.8	220
240	100	4.7	220
380	56	3	68
450	47	2.7	47

For fully differential IF architectures, the IF transformer can be eliminated. An example is shown in Figure 14, where the mixer's IF output is matched directly into a SAW filter. Supply voltage to the mixer's IF pins is applied through

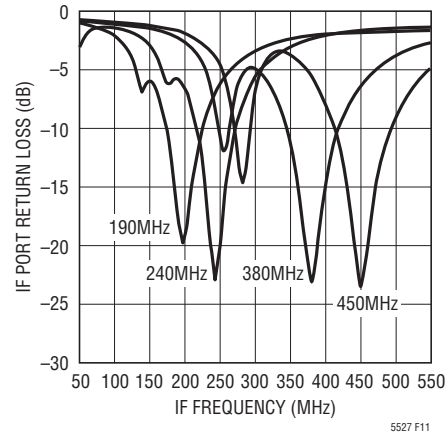

Figure 11. IF Output Return Losses with Discrete Balun Matching

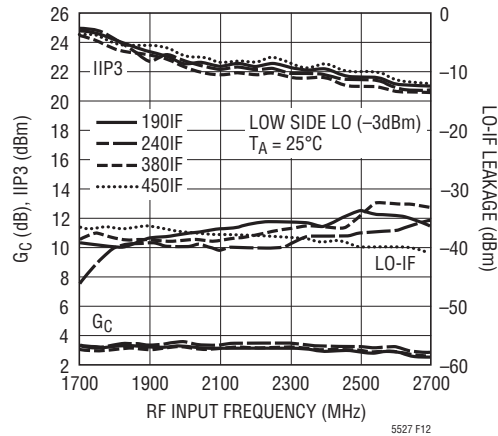

Figure 12. Conversion Gain, IIP3 and LO-IF Leakage vs RF Input Frequency Using Discrete IF Balun Matching

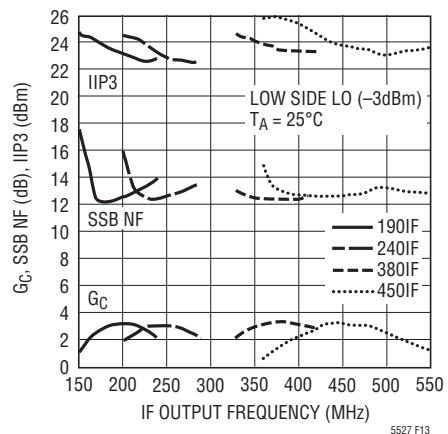

Figure 13. Conversion Gain, IIP3 and SSB NF vs IF Output Frequency Using Discrete IF Balun Matching

APPLICATIONS INFORMATION

matching inductors in a band-pass IF matching network. The values of L1, L2 and C3 are calculated to resonate at the desired IF frequency with a quality factor that satisfies the required IF bandwidth. The L and C values are then adjusted to account for the mixer's internal 2.5pF capacitance and the SAW filter's input capacitance. In this case, the differential IF output impedance is 400Ω since the bandpass network does not transform the impedance.

Additional matching elements may be required if the SAW filter's input impedance is less than or greater than 400Ω. Contact the factory for application assistance.

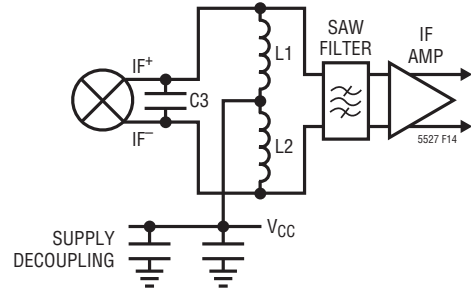
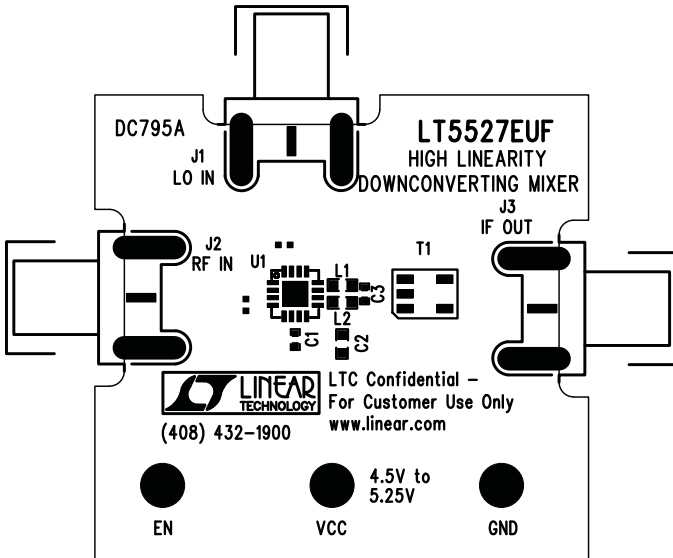
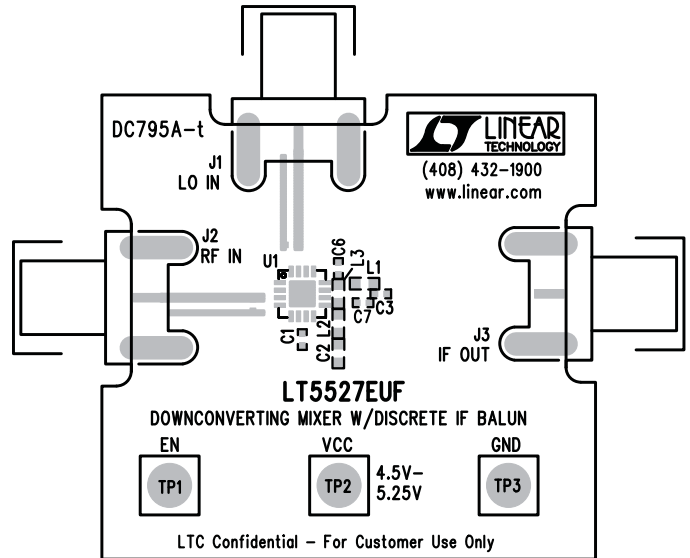

Figure 14. Bandpass IF Matching for Differential IF Architectures

Standard Evaluation Board Layout



Discrete IF Evaluation Board Layout



PACKAGE DESCRIPTION

UF Package
16-Lead Plastic QFN (4mm × 4mm)
 (Reference LTC DWG # 05-08-1692)

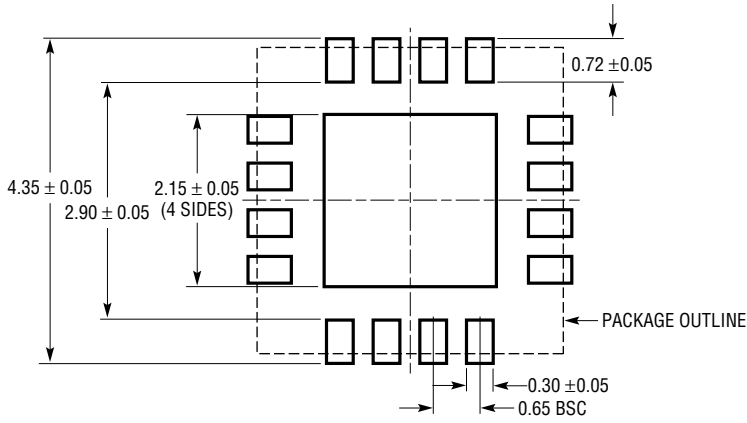

RECOMMENDED SOLDER PAD PITCH AND DIMENSIONS

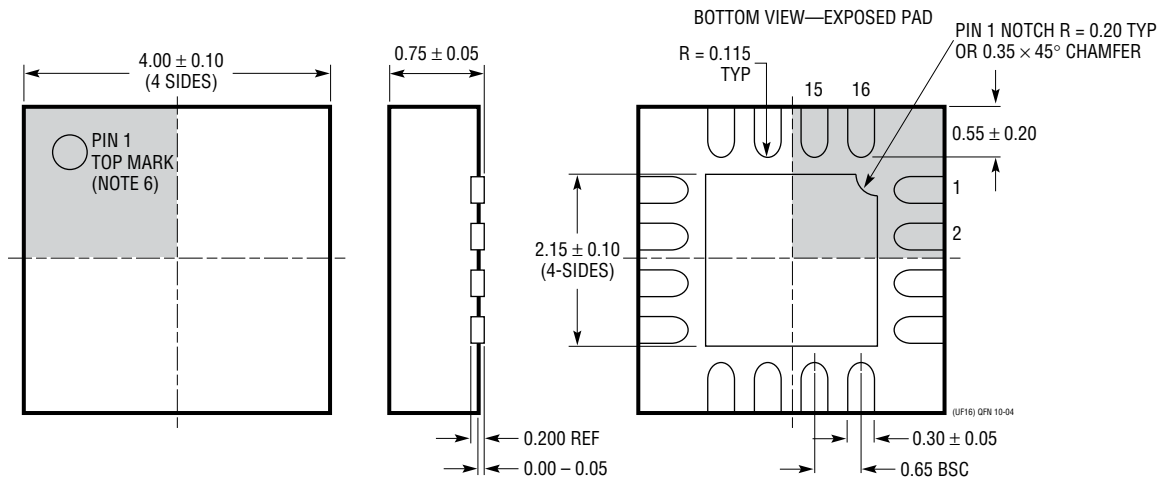

- NOTE:
1. DRAWING CONFORMS TO JEDEC PACKAGE OUTLINE MO-220 VARIATION (WGFC)
 2. DRAWING NOT TO SCALE
 3. ALL DIMENSIONS ARE IN MILLIMETERS
 4. DIMENSIONS OF EXPOSED PAD ON BOTTOM OF PACKAGE DO NOT INCLUDE MOLD FLASH. MOLD FLASH, IF PRESENT, SHALL NOT EXCEED 0.15mm ON ANY SIDE
 5. EXPOSED PAD SHALL BE SOLDER PLATED
 6. SHADED AREA IS ONLY A REFERENCE FOR PIN 1 LOCATION ON THE TOP AND BOTTOM OF PACKAGE

RELATED PARTS

PART NUMBER	DESCRIPTION	COMMENTS
Infrastructure		
LT5511	High Linearity Upconverting Mixer	RF Output to 3GHz, 17dBm IIP3, Integrated LO Buffer
LT5512	1kHz to 3GHz High Signal Level Active Mixer	Optimized for HF/VHF/UHF Applications, 20dBm IIP3 11dB NF
LT5514	Ultralow Distortion, IF Amplifier/ADC Driver with Digitally Controlled Gain	850MHz Bandwidth, 47dBm OIP3 at 100MHz, 10.5dB to 33dB Gain Control Range
LT5515	1.5GHz to 2.5GHz Direct Conversion Quadrature Demodulator	20dBm IIP3, Integrated LO Quadrature Generator
LT5516	0.8GHz to 1.5GHz Direct Conversion Quadrature Demodulator	21.5dBm IIP3, Integrated LO Quadrature Generator
LT5517	40MHz to 900MHz Quadrature Demodulator	21dBm IIP3, Integrated LO Quadrature Generator
LT5519	0.7GHz to 1.4GHz High Linearity Upconverting Mixer	17.1dBm IIP3 at 1GHz, Integrated RF Output Transformer with 50Ω Matching, Single-Ended LO and RF Ports Operation
LT5520	1.3GHz to 2.3GHz High Linearity Upconverting Mixer	15.9dBm IIP3 at 1.9GHz, Integrated RF Output Transformer with 50Ω Matching, Single-Ended LO and RF Ports Operation
LT5521	10MHz to 3700MHz High Linearity Upconverting Mixer	24.2dBm IIP3 at 1.95GHz, NF = 12.5dB, 3.15V to 5.25V Supply, Single-Ended LO Port Operation
LT5522	400MHz to 2.7GHz High Signal Level Downconverting Mixer	4.5V to 5.25V Supply, 25dBm IIP3 at 900MHz, NF = 12.5dB, 50Ω Single-Ended RF and LO Ports
LT5524	Low Power, Low Distortion ADC Driver with Digitally Programmable Gain	450MHz Bandwidth, 40dBm OIP3, 4.5dB to 27dB Gain Control
LT5525	High Linearity, Low Power Downconverting Mixer	Single-Ended 50Ω RF and LO Ports, 17.6dBm IIP3 at 1900MHz, I _{CC} = 28mA
LT5526	High Linearity, Low Power Downconverting Mixer	3V to 5.3V Supply, 16.5dBm IIP3, 100kHz to 2GHz RF, NF = 11dB, I _{CC} = 28mA, -65dBm LO-RF Leakage
LT5557	400MHz to 3.8GHz, 3.3V High Signal Level Downconverting Mixer	Single-Ended RF and LO Ports, 24.7dBm IIP3 at 1950MHz, NF = 11.7dB
RF Power Detectors		
LT5504	800MHz to 2.7GHz RF Measuring Receiver	80dB Dynamic Range, Temperature Compensated, 2.7V to 5.25V Supply
LTC®5505	RF Power Detectors with >40dB Dynamic Range	300MHz to 3GHz, Temperature Compensated, 2.7V to 6V Supply
LTC5507	100kHz to 1000MHz RF Power Detector	100kHz to 1GHz, Temperature Compensated, 2.7V to 6V Supply
LTC5508	300MHz to 7GHz RF Power Detector	44dB Dynamic Range, Temperature Compensated, SC70 Package
LTC5509	300MHz to 3GHz RF Power Detector	36dB Dynamic Range, Low Power Consumption, SC70 Package
LTC5530	300MHz to 7GHz Precision RF Power Detector	Precision V _{OUT} Offset Control, Shutdown, Adjustable Gain
LTC5531	300MHz to 7GHz Precision RF Power Detector	Precision V _{OUT} Offset Control, Shutdown, Adjustable Offset
LTC5532	300MHz to 7GHz Precision RF Power Detector	Precision V _{OUT} Offset Control, Adjustable Gain and Offset
LT5534	50MHz to 3GHz RF Power Detector with 60dB Dynamic Range	±1dB Output Variation over Temperature, 38ns Response Time
LTC5536	Precision 600MHz to 7GHz RF Detector with Fast Comparator Output	25ns Response Time, Comparator Reference Input, Latch Enable Input, -26dBm to +12dBm Input Range
Low Voltage RF Building Block		
LT5546	500MHz Quadrature Demodulator with VGA and 17MHz Baseband Bandwidth	17MHz Baseband Bandwidth, 40MHz to 500MHz IF, 1.8V to 5.25V Supply, -7dB to 56dB Linear Power Gain
Wide Bandwidth ADCs		
LTC1749	12-Bit, 80Msps	500MHz BW S/H, 71.8dB SNR
LTC1750	14-Bit, 80Msps	500MHz BW S/H, 75.5dB SNR

Компания «Океан Электроники» предлагает заключение долгосрочных отношений при поставках импортных электронных компонентов на взаимовыгодных условиях!

Наши преимущества:

- Поставка оригинальных импортных электронных компонентов напрямую с производств Америки, Европы и Азии, а так же с крупнейших складов мира;
- Широкая линейка поставок активных и пассивных импортных электронных компонентов (более 30 млн. наименований);
- Поставка сложных, дефицитных, либо снятых с производства позиций;
- Оперативные сроки поставки под заказ (от 5 рабочих дней);
- Экспресс доставка в любую точку России;
- Помощь Конструкторского Отдела и консультации квалифицированных инженеров;
- Техническая поддержка проекта, помощь в подборе аналогов, поставка прототипов;
- Поставка электронных компонентов под контролем ВП;
- Система менеджмента качества сертифицирована по Международному стандарту ISO 9001;
- При необходимости вся продукция военного и аэрокосмического назначения проходит испытания и сертификацию в лаборатории (по согласованию с заказчиком);
- Поставка специализированных компонентов военного и аэрокосмического уровня качества (Xilinx, Altera, Analog Devices, Intersil, Interpoint, Microsemi, Actel, Aeroflex, Peregrine, VPT, Syfer, Eurofarad, Texas Instruments, MS Kennedy, Miteq, Cobham, E2V, MA-COM, Hittite, Mini-Circuits, General Dynamics и др.);

Компания «Океан Электроники» является официальным дистрибьютором и эксклюзивным представителем в России одного из крупнейших производителей разъемов военного и аэрокосмического назначения «JONHON», а так же официальным дистрибьютором и эксклюзивным представителем в России производителя высокотехнологичных и надежных решений для передачи СВЧ сигналов «FORSTAR».



JONHON

«JONHON» (основан в 1970 г.)

Разъемы специального, военного и аэрокосмического назначения:

(Применяются в военной, авиационной, аэрокосмической, морской, железнодорожной, горно- и нефтедобывающей отраслях промышленности)

«FORSTAR» (основан в 1998 г.)

ВЧ соединители, коаксиальные кабели, кабельные сборки и микроволновые компоненты:

(Применяются в телекоммуникациях гражданского и специального назначения, в средствах связи, РЛС, а так же военной, авиационной и аэрокосмической отраслях промышленности).



Телефон: 8 (812) 309-75-97 (многоканальный)

Факс: 8 (812) 320-03-32

Электронная почта: ocean@oceanchips.ru

Web: <http://oceanchips.ru/>

Адрес: 198099, г. Санкт-Петербург, ул. Калинина, д. 2, корп. 4, лит. А