

### General Description

The MIC2012 is a dual channel USB power switch designed to support the power distribution requirements for USB Wakeup from the ACPI S3 state. The MIC2012 will directly switch its two outputs between a 5V main supply and a 5V auxiliary supply normally provided in ATX style power supplies.

The MIC2012 will adjust its current-limit threshold according to the ACPI state it is in. In the normal active S0 state the current-limit is set at 500mA minimum per channel satisfying the USB continuous output current specification. In the S3 state the current-limit can be reduced to only 100mA per channel to minimize the current that is supplied by the auxiliary supply thereby ensuring that voltage regulation is maintained even during fault conditions.

The MIC2012 provides make-before-break switching to ensure glitch-free transitions between the S3 and S0 states. Each channel is also thermally isolated from the other so that a fault in one channel does not effect the other. FAULT status output signals are also provided indicating overcurrent and thermal shutdown conditions.

The MIC2072 option latches the output off upon detecting an overcurrent condition for more than 5ms minimum. The output can be reset by either toggling the EN inputs of the MIC2072-1, -2 or by removing the load. Latching the output off provides a circuit breaker mode of operation which reduces power consumption during fault conditions.

### Features

- Compliant to USB power distribution specifications
- UL Recognized Component
- Two completely independent switches
- Integrated switching matrix supports ACPI S0/S3 state transitions without external FET circuits
- Make-before-break switching ensures glitch-free transitions
- No back-feed of auxiliary supply onto main supply during standby mode
- Bi-level current-limit preserves auxiliary supply voltage regulation in standby mode
- Thermally isolated channels
- Thermal shutdown protection
- Fault status outputs with filter prevents false assertions during hot-plug events
- Latched thermal shutdown options with auto-reset (MIC2072)
- Undervoltage lockout

### Applications

- Desktop PCs
- Notebook PCs
- Notebook Docking stations
- LAN Servers
- PC Motherboards

### Typical Application

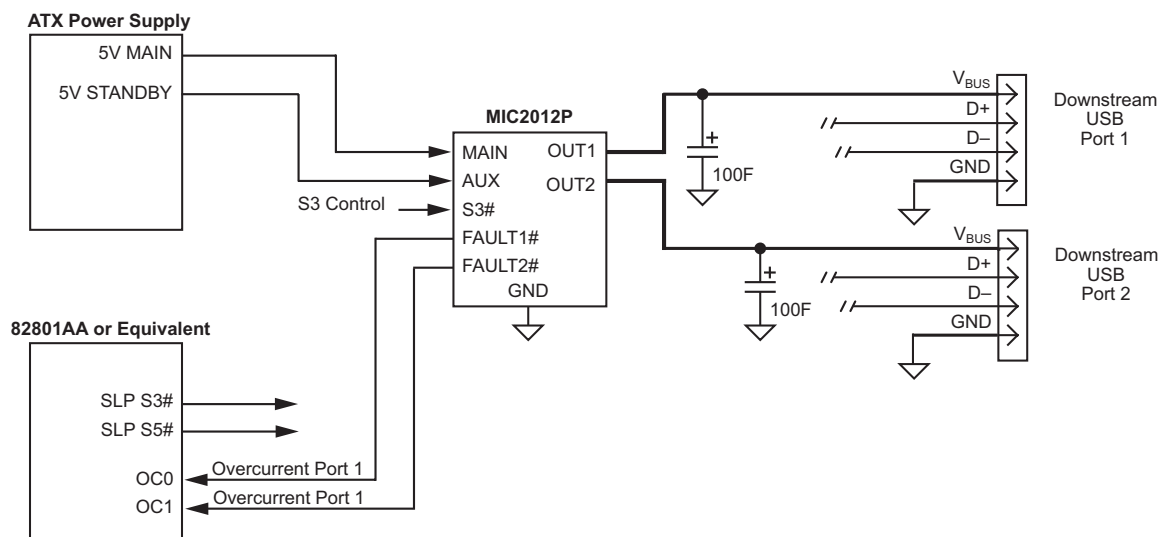


Figure 1. USB Wakeup with Control Input



UL Recognized Component

Micrel, Inc. • 2180 Fortune Drive • San Jose, CA 95131 • USA • tel + 1 (408) 944-0800 • fax + 1 (408) 474-1000 • <http://www.micrel.com>

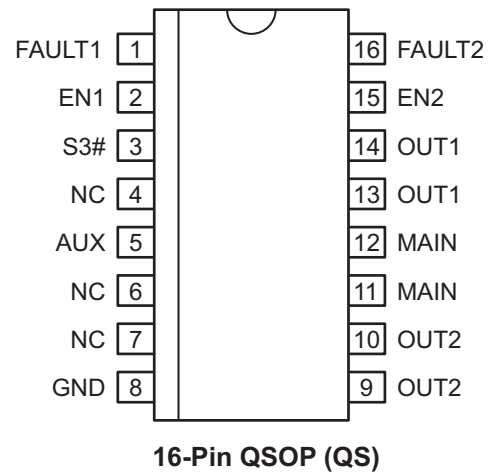
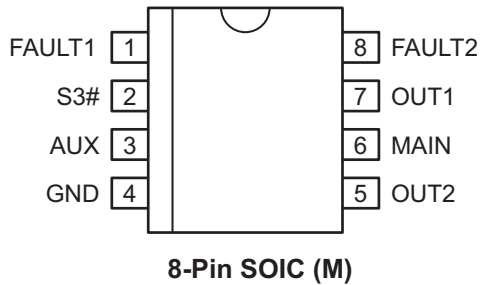
## Ordering Information

Part Number		Enable	Fault Output	Circuit Breaker Range	Temperature Range	Package
Standard	Pb-Free					
MIC2012BM <sup>(1)</sup>	MIC2012YM <sup>(1)</sup>	n/a	Open-Drain		0°C to +70°C	8-lead SOIC
MIC2012CM	MIC2012ZM	n/a	Open-Drain		0°C to +70°C	8-lead SOIC
MIC2012PCM	MIC2012PZM	n/a	Internal Pull-Up		0°C to +70°C	8-lead SOIC
MIC2012-1PCQS	MIC2012-1PZQS	Active High	Internal Pull-Up		0°C to +70°C	16-lead QSOP
MIC2012-2PCQS	MIC2012-2PZQS	Active Low	Internal Pull-Up		0°C to +70°C	16-lead QSOP
MIC2072-1PCQS	MIC2072-2PZQS	Active High	Internal Pull-Up	Δ	0°C to +70°C	16-lead QSOP
MIC2072-2PCQS	MIC2072-2PZQS	Active Low	Internal Pull-Up	Δ	0°C to +70°C	16-lead QSOP

### Note:

1. Contact factory for availability

## Pin Configuration



**Pin Description**

Pin Number (MIC2012)	Pin Number (MIC2012-1, -2)	Pin Name	Pin Function
1	1	FAULT1	Fault Status (Output): Internal pull-up or open-drain. Asserted LOW when Channel is in a thermal shutdown state or overcurrent condition for more than 5ms. MIC2072 latches this output in its asserted state upon an overcurrent condition. Toggling EN1 or removing the load will reset the circuit breaker latch and deassert FAULT1.
n/a	2	EN1	Enable (Input): Channel 1, active-high (-1) or active-low (-2). Toggling this input also resets the latched output of the MIC2072.
2	3	S3#	Control (Input): When this input is HIGH, the MAIN inputs are connected to OUT1 and OUT2 via 100mΩ MOSFET switches. When this input is LOW the AUX inputs are connected to OUT1 and OUT2 via 500mΩ MOSFET switches.
3	5	AUX	Auxiliary 5V Supply (Input): Also used as power supply for internal circuitry.
n/a	4, 6, 7	NC	No Connection: This pin may be connected to other pins without restriction.
4	8	GND	Ground
5	9, 10	OUT2	Channel 2 (Output): For MIC2012-1, -2 both pins must be externally connected together.
6	11, 12	MAIN	5V Main Supply (Input): All MAIN inputs must be connected together externally.
7	13, 14	OUT1	Channel 1 (Output): For MIC2012-1, -2 both pins must be externally connected together.
n/a	15	EN2	Enable (Input): Channel 2, active-high (-1) or active-low (-2). Toggling this input also resets the latched output of the MIC2072.
8	16	FAULT2	Fault Status (Output): Internal pull-up or open-drain. Asserted LOW when Channel 2 is in a thermal shutdown state or overcurrent condition for more than 5ms. MIC2072 latches this output in its asserted state upon an overcurrent condition. Toggling EN2 or removing the load will reset the circuit breaker latch and deassert FAULT2.

**Absolute Maximum Ratings (Note 1, Note 4)**

Supply Voltage ( $V_{IN}$ , $V_{MAIN}$ , $V_{AUX}$ ).....	-0.3V to 6V
EN1, EN2, S3# Input Pins .....	-0.3V to 6V
FAULT#, OUT1, OUT2 Output Pins.....	-0.3V to 6V
FAULT Output Current.....	25mA
ESD Rating, <b>Note 3</b> .....	2kV

**Operating Ratings (Note 2)**

Supply Voltage ( $V_{MAIN}$ , $V_{AUX}$ ).....	+4.5V to +5.5V
Ambient Temperature ( $T_A$ ).....	-0°C to +70°C
Junction Temperature ( $T_J$ ).....	Internally Limited
Package Thermal Resistance	
QSOP ( $\theta_{JA}$ ).....	163°C/W
SOIC ( $\theta_{JA}$ ).....	160°C/W

**Electrical Characteristics**

$V_{MAIN} = 5V$ ;  $AUX = 5V$ ;  $T_A = 25^\circ C$ ; unless noted

Symbol	Parameter	Condition	Min	Typ	Max	Units
$V_{MAIN}$	MAIN Supply Voltage		4.5	5.0	5.5	V
$I_{MAIN(ON)}$	MAIN Supply Current Switches On <b>Note 5</b>	S3# = 1, no load		16	22	$\mu A$
$I_{MAIN(OFF)}$	MAIN Supply Current Switches Off <b>Note 5</b> , (MIC20x2-1, MIC20x2-2 only)	S3# = 1, no load			5	$\mu A$
$I_{LEAK}$	MAIN Reverse Leakage Current,	S3# = 0, both switches ON, $V_{MAIN} = 0V$	-10		+10	$\mu A$
$V_{AUX}$	AUX Supply Voltage		4.5	5.0	5.5	V
$I_{AUX ON}$	AUX Supply Current, both switches on, <b>Note 5</b>	No load S3# = 0		0.6	1	mA
$I_{AUX OFF}$	AUX Supply Current, switches off. (MIC20x2-1, MIC20x2-2 only)	No load S3# = 0			5	$\mu A$
$V_{UV/AUX}$	AUX Undervoltage Lockout Threshold	$V_{AUX}$ increasing $V_{AUX}$ decreasing		3.1 2.9	4.0 3.8	V V
$V_{HYS}$	AUX Undervoltage Lockout Hysteresis			200		mV
$R_{DSMAIN}$	MAIN On-Resistance, Each Output	S3# = 1, $I_{OUT} = 500mA$		100	140	m $\Omega$
$R_{DSAUX}$	AUX On-Resistance, Each Output	S3# = 0, $I_{OUT} = 100mA$		500	700	m $\Omega$
$I_{LIMIT(MAIN)}$	MAIN Current-Limit Threshold	S3# = 1, $V_{OUT} = 4.0V$ , ramped load	0.8		2.0	A
	MAIN Short-Circuit Current-Limit	$V_{OUT} = 0V$	0.65		1.8	A
$I_{LIMIT(AUX)}$	AUX Current-Limit Threshold	S3# = 0, $V_{OUT} = 4.0V$ , ramped load	105	150	195	mA
	AUX Short-Circuit Current-Limit	$V_{OUT} = 0V$ , $C_{OUT} = 100\mu F$		80		mA
$V_{TH}$	S3#, EN1, EN2. Input Threshold Voltage (EN1, EN2, for MIC20x2-x only)	High-to-Low transition	0.8	1.5		V
		Low-to-High transition		1.7	2.0	V
$V_{HYS}$	EN1, EN2 and S3# Input Hysteresis (EN1, EN2, for MIC20x2-x only)			200		mV
$I_{IN}$	S3#, EN1, EN2 Input Current (EN1, EN2, for MIC20x2-x only)	$V_{S3/EN} = 5V, 0V$	-1		1	$\mu A$
$I_{OFF}$	OUT1, OUT2 Leakage Current (MIC2012-x, MIC2072-x only)	Outputs are off, $V_{OUT} = 0$	-10		10	$\mu A$
	Pull-Up Current During Latched Output State (MIC2072-1, -2)	Outputs latched off		1		mA

Symbol	Parameter	Condition	Min	Typ	Max	Units
$V_{TH\ LATCH}$	Latch Reset Threshold (MIC2072, MIC2072-x only)	$V_{OUT}$ Rising		1.95		V
	Minimum Output Slew Rate to Reset Latch (MIC2072, MIC2072-x only), <b>Note 6</b>			0.4		V/s
	Overtemperature Threshold	$T_J$ increasing, single channel $T_J$ decreasing, single channel $T_J$ increasing, both channels $T_J$ decreasing, both channels		140 120 160 150		°C °C °C °C
$V_{OL}$	FAULT Output Low Voltage	$I_{FAULT} = 5\text{mA}$			0.2	V
$V_{OH}$	FAULT Output High Voltage (MIC2012-1P,-2P),(MIC2072-1P,-2P)	$I_{FAULT} = -20\mu\text{A}$	4			V
	FAULT Output Off Current (Not Applicable to 'P' Options)	$V_{FAULT} = 5\text{V}$		0.2	10	$\mu\text{A}$
$T_H$	MAIN to S3# Hold Time, <b>Note 6</b>	Figure 5	5			ms
$T_S$	MAIN to S3# Set-up Time, <b>Note 6</b>	Figure 5	0			ms
$t_{DLY}$	FAULT Delay Filter Response Time (Overcurrent only), <b>Note 7</b>	Output shorted to ground, Figure 4	5	10	20	ms
$t_{OC}$	Overcurrent Response Time	Output shorted to ground, Figure 4 MAIN output AUX output		2 2		$\mu\text{s}$ $\mu\text{s}$
$t_{ON(MAIN)}$	MAIN Output Turn-On Time	$R_L = 10\Omega$ , $C_L = 1\mu\text{F}$ , Figure 3		2		ms
$t_{OFF(MAIN)}$	MAIN Output Turn-Off Time (MIC20x2-x only)	$R_L = 10\Omega$ , $C_L = 1\mu\text{F}$ , Figure 3		35		$\mu\text{s}$
$t_{r(MAIN)}$	MAIN Output Rise Time	$R_L = 10\Omega$ , $C_L = 1\mu\text{F}$ , Figure 3		2		ms
$t_{f(MAIN)}$	MAIN Output Fall Time (MIC20x2-x only)	$R_L = 10\Omega$ , $C_L = 1\mu\text{F}$ , Figure 3		32		$\mu\text{s}$
$t_{ON(AUX)}$	AUX Output Turn-On Time	$R_L = 50\Omega$ , $C_L = 1\mu\text{F}$ , Figure 3		0.6		ms
$t_{OFF(AUX)}$	AUX Output Turn-Off Time (MIC20x2-x only)	$R_L = 50\Omega$ , $C_L = 1\mu\text{F}$ , Figure 3		120		$\mu\text{s}$
$t_{r(AUX)}$	AUX Output Rise Time	$R_L = 50\Omega$ , $C_L = 1\mu\text{F}$ , Figure 3		0.5		ms
$t_{f(AUX)}$	AUX Output Fall Time (MIC20x2-x only)	$R_L = 50\Omega$ , $C_L = 1\mu\text{F}$ , Figure 3		115		$\mu\text{s}$
$t_{XMA}$	MAIN to AUX Cross Conduction Time, <b>Note 8</b>	S3# transition to 0		5	7.5	ms
$t_{XAM}$	AUX to MAIN Cross Conduction Time, <b>Note 8</b>	S3# transition to 1		5	7.5	ms

**Note 1.** Exceeding the absolute maximum rating may damage the device.

**Note 2.** The device is not guaranteed to function outside its operating rating.

**Note 3.** Devices are ESD sensitive. Handling precautions recommended. Human body model, 1.5k in series with 100pF.

**Note 4.** All voltages are referenced to ground.

**Note 5.** For MIC20x2-1(P) OFF occurs when  $V_{EN} < 0.8\text{V}$  and ON occurs when  $V_{EN} > 2.4\text{V}$ . For MIC20x2-2(P) OFF occurs when  $V_{EN} > 2.4\text{V}$  and ON occurs when  $V_{EN} < 0.8\text{V}$ .

**Note 6.** Guaranteed by design. Not production tested.

**Note 7.** Assumes only one channel in current-limit. Delay circuitry is shared among channels so it is possible for  $t_{DLY}$  to be 40ms max if one channel enters current-limit as the other is about to time-out.

**Note 8.** Cross conduction time is the duration in which both MAIN and AUX internal switches are on subsequent to S3# transitioning.

# Timing Diagrams

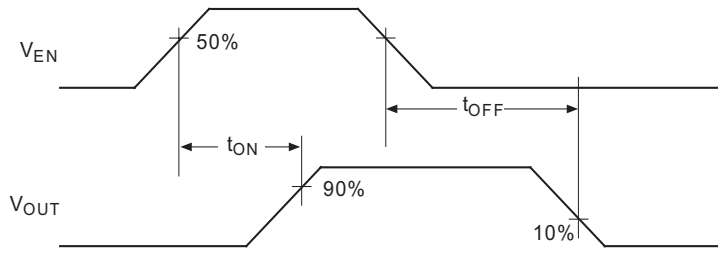


Figure 2. MIC2012/72-1

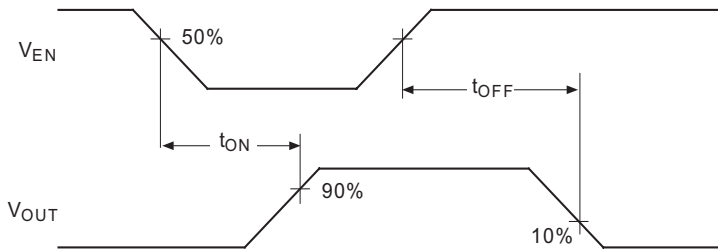


Figure 3. MIC2012/72-2

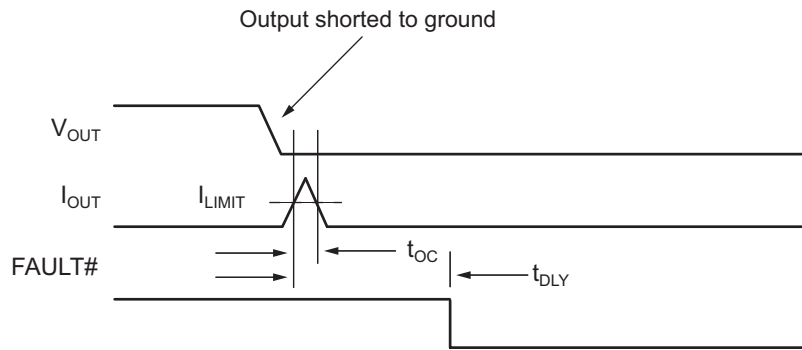


Figure 4. Overcurrent Response Timing

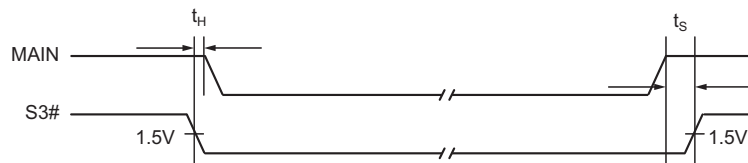
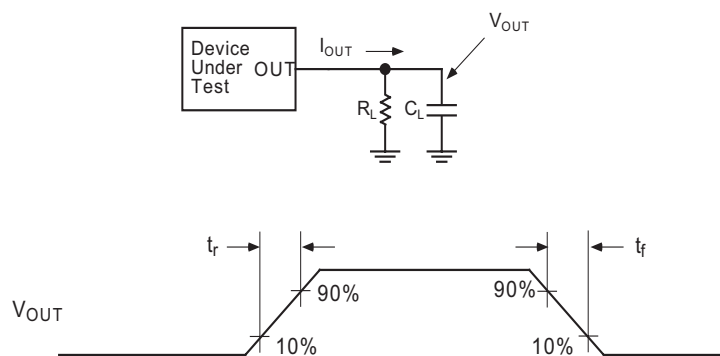
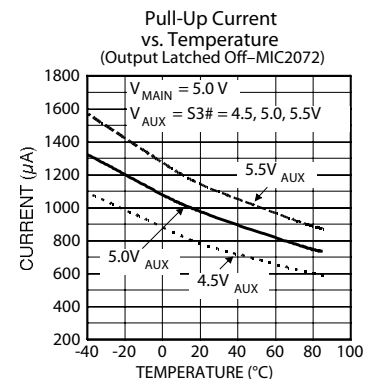
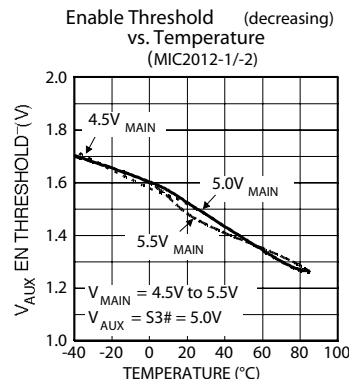
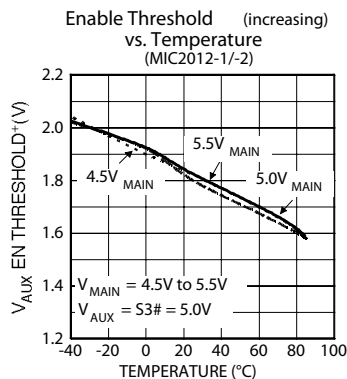
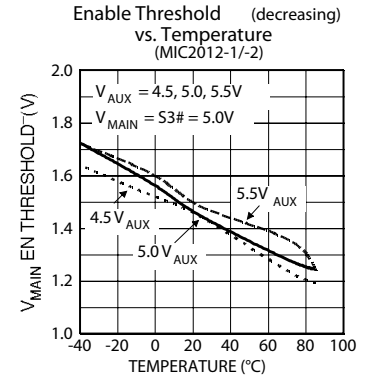
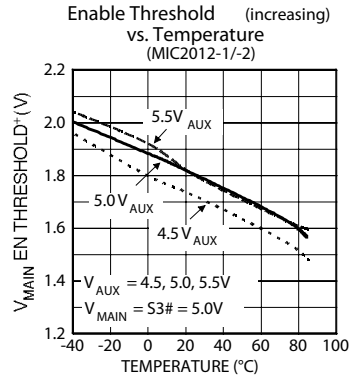
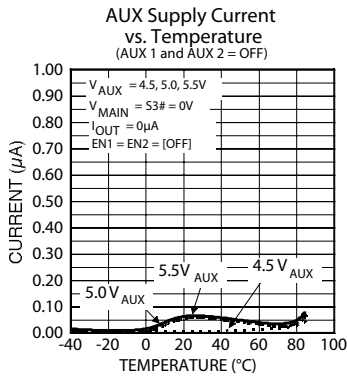
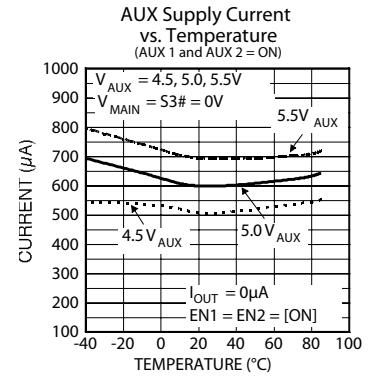
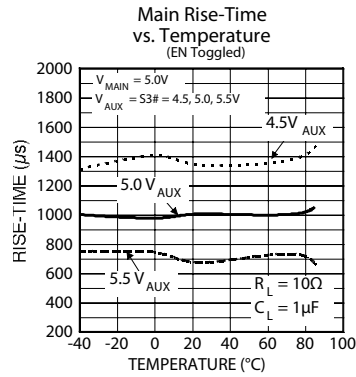
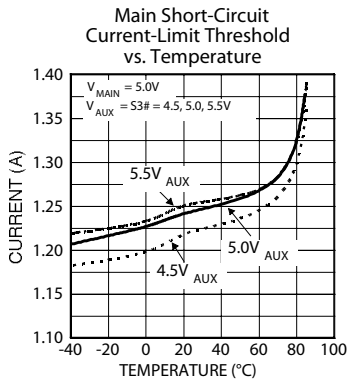
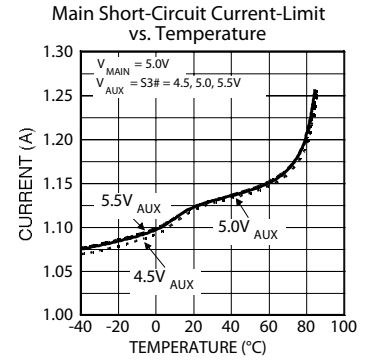
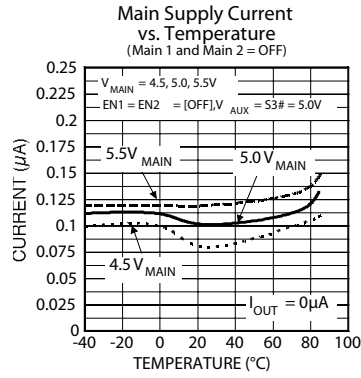
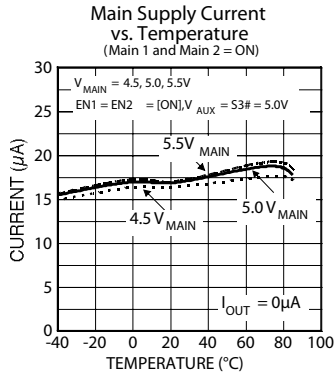


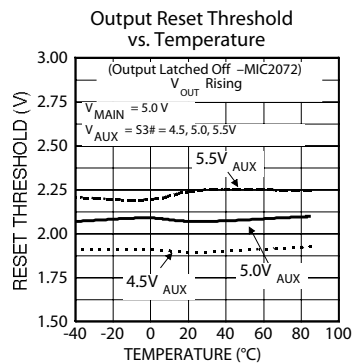
Figure 5. MAIN to S3# Timing

**Test Circuit**

# Typical Characteristics

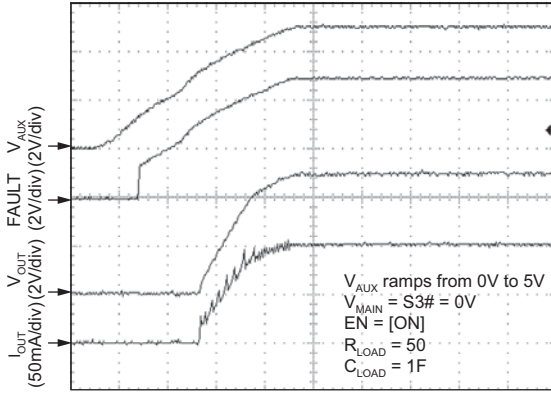






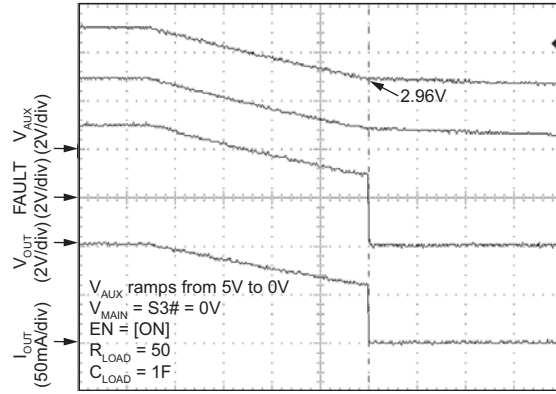
# Functional Characteristics

**AUX Start-up by UVLO**



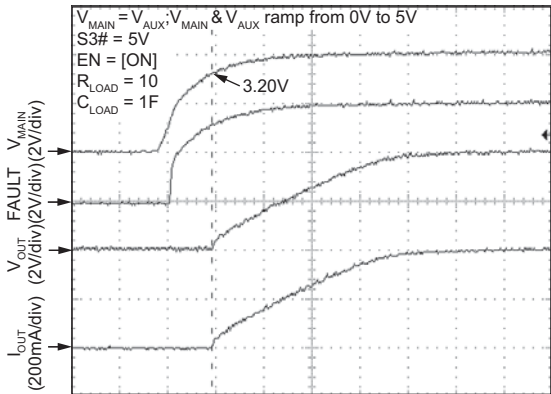
TIME (500s/div)

**AUX Shutdown by UVLO**



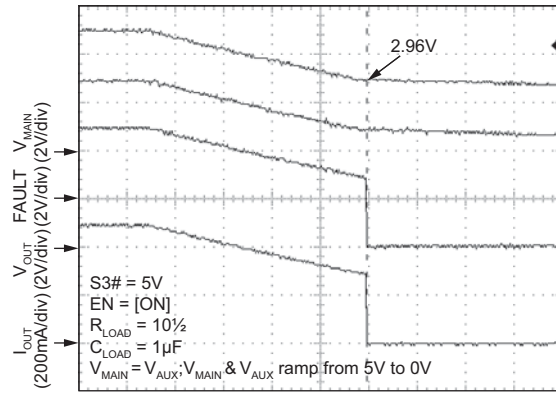
TIME (10ms/div)

**Main Start-up by UVLO**



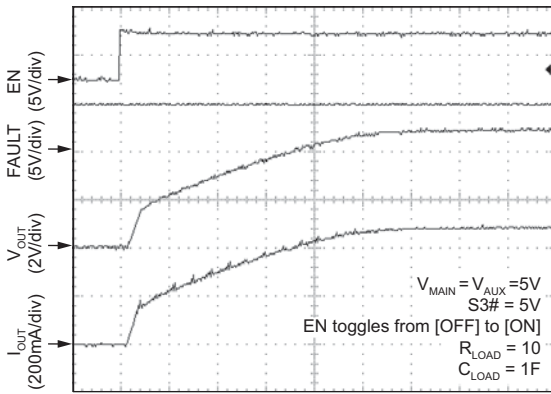
TIME (500s/div)

**Main Shut-down by UVLO**



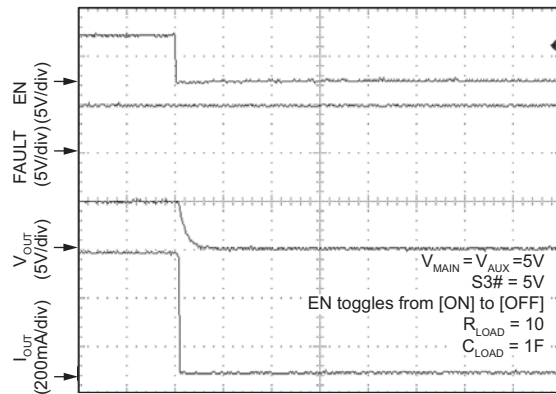
TIME (10ms/div)

**Main Turn-On Response**



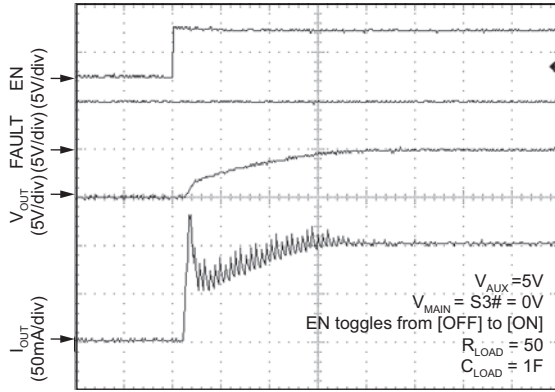
TIME (250s/div)

**Main Turn-Off Response**



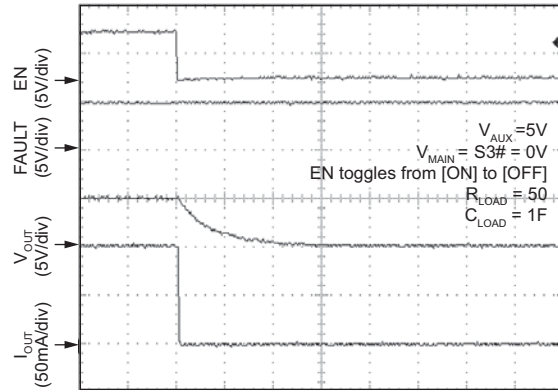
TIME (100s/div)

**AUX Turn-On Response**



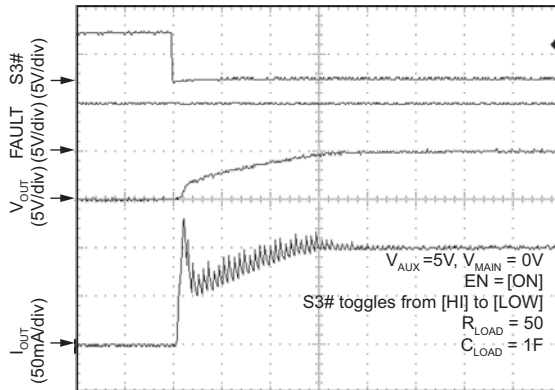
TIME (100s/div)

**AUX Turn-Off Response**



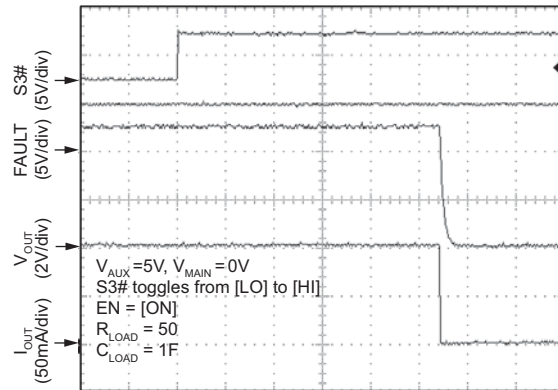
TIME (100s/div)

**Turn-On from S3# to AUX**



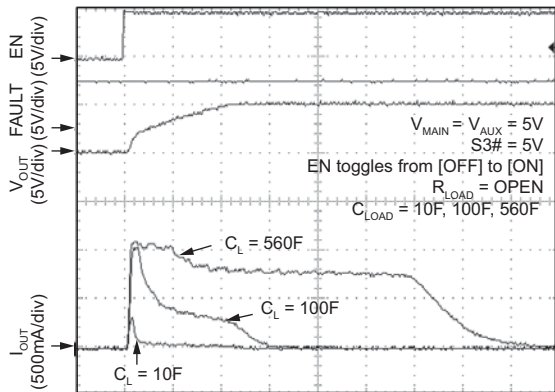
TIME (100s/div)

**Turn-Off from AUX to S3#**



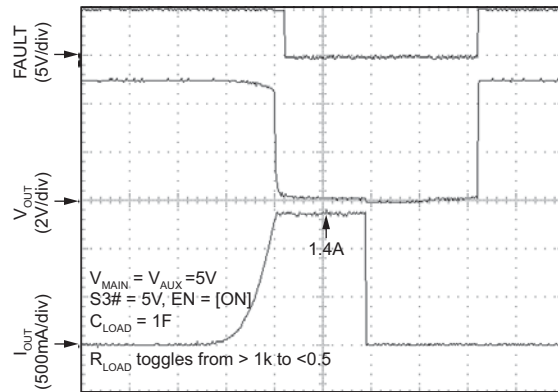
TIME (1ms/div)

**Main Inrush Current into C\_LOAD**



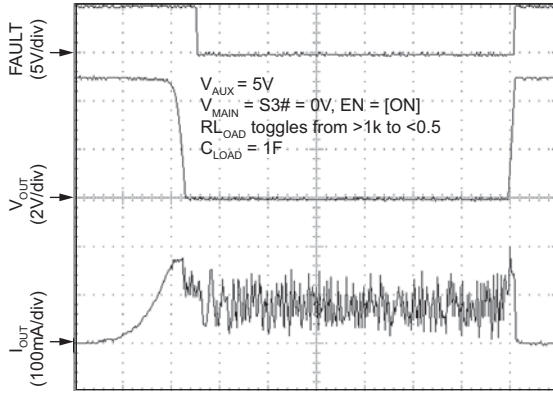
TIME (500s/div)

**Main-Ramped to Short by MOSFET**



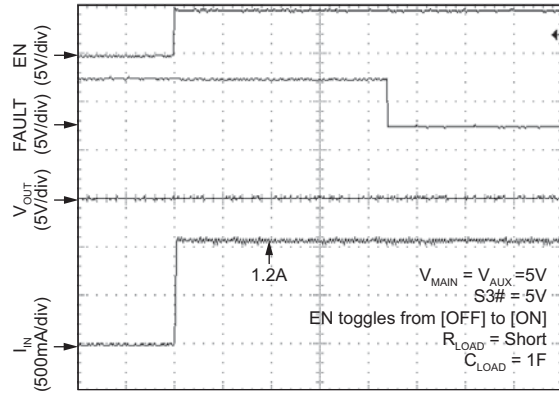
TIME (50ms/div)

**AUX Ramped to Short by MOSFET**



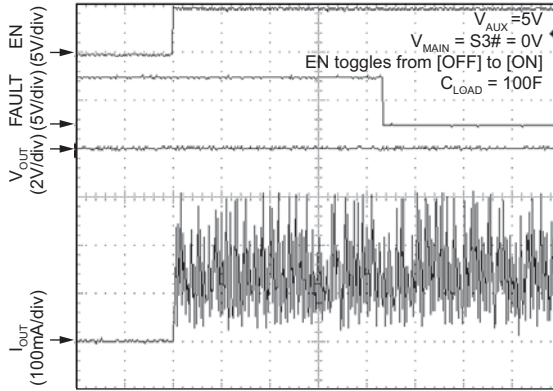
TIME (25ms/div)

**Main Turn-On into Short**



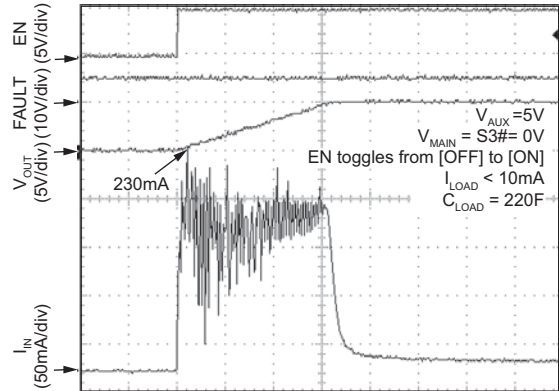
TIME (2.5ms/div)

**AUX Turn-On into Short**



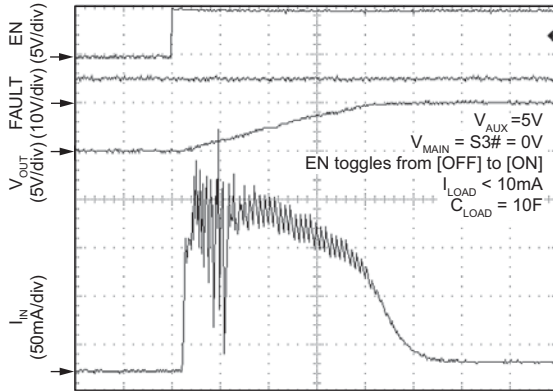
TIME (2.5ms/div)

**AUX Inrush Current into Large C\_LOAD**



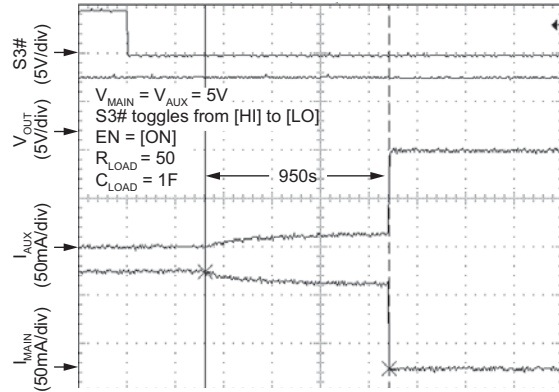
TIME (2.5ms/div)

**AUX Inrush Current into Small C\_LOAD**

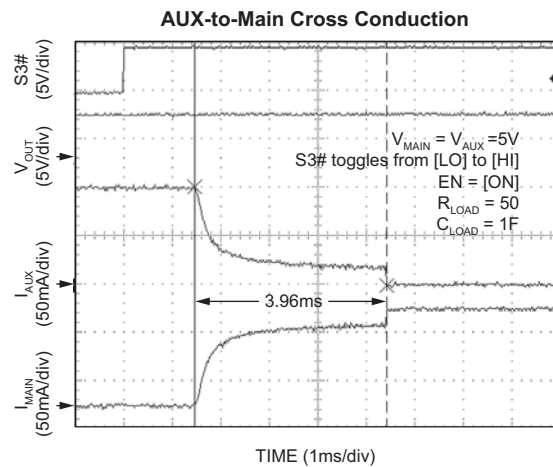


TIME (100s/div)

**Main-to-AUX Cross Conduction**



TIME (250s/div)





dead short on the output.

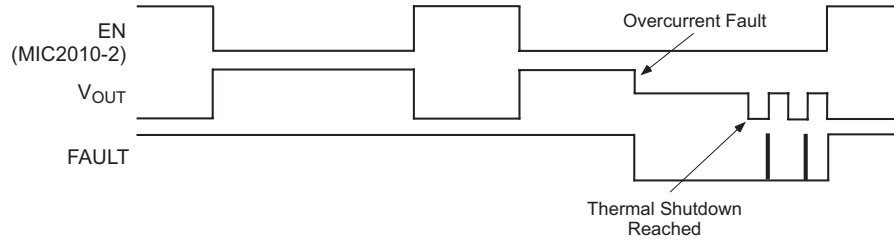
**Fault Status Output**

The FAULT signal is an active-low output with an open-drain or weak pull-up configuration. FAULT is asserted (active-low) when either an overcurrent or thermal shutdown condition occurs. In the case of an overcurrent condition, FAULT will be asserted only after the flag response delay time,  $t_{DLY}$ , has elapsed. This ensures that FAULT is asserted only upon valid overcurrent conditions and that erroneous error reporting is eliminated. For example, false overcurrent conditions can occur during hot-plug events when a highly capacitive load is connected and causes a high transient inrush current that

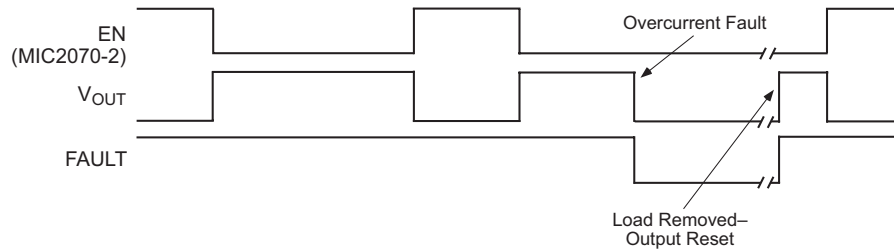
exceeds the current-limit threshold. The FAULT response delay time  $t_{DLY}$  is typically 10ms.

**Undervoltage Lockout**

Undervoltage lockout (UVLO) prevents the output MOSFET from turning on until the AUX input exceeds approximately 3.5V. UVLO ensures that the output MOSFETs remain off to prevent high transient inrush current due to stray or bulk load capacitance. This helps to ensure that the power supply

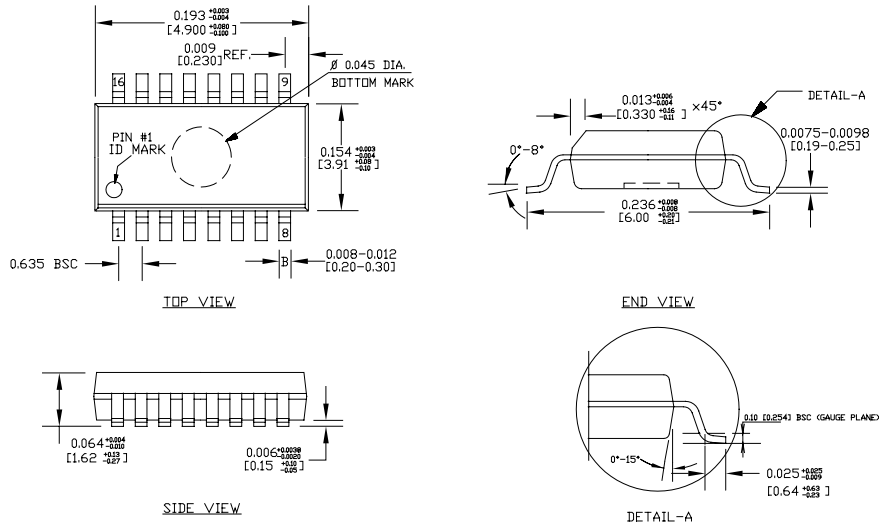


**Figure 6. MIC2012 System Timing**



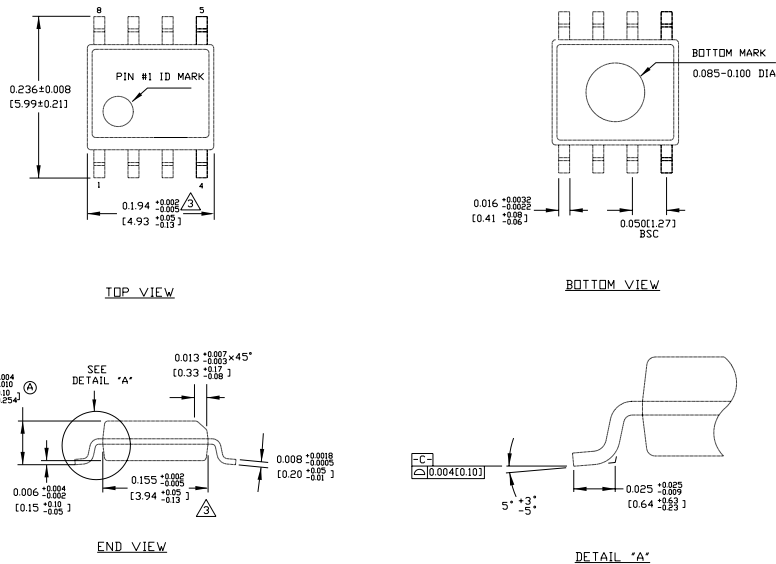
**Figure 7. MIC2072 System Timing—  
Output Resets When Load is Removed**

Package Information



- NOTE:**
1. ALL DIMENSIONS ARE IN INCHES [MM].
  2. LEAD COPLANARITY SHOULD BE 0.004" [0.10 mm] MAX.
  3. MAX MISALIGNMENT BETWEEN TOP AND BOTTOM CENTER OF PACKAGE TO BE 0.004" [0.10 mm].
  4. THE LEAD WIDTH, B TO BE DETERMINED AT .0075 [0.19 mm] FROM THE LEAD TIP.
  5. BOTTOM MARK IS OPTIONAL, IT MAY NOT APPEAR ON THE ACTUAL UNITS.

16-Pin QSOP (QS)



- NOTES:**
1. DIMENSIONS ARE IN INCHES[MM].
  2. CONTROLLING DIMENSION: INCHES.
  3. DIMENSION DOES NOT INCLUDE MOLD FLASH OR PROTRUSIONS, EITHER OF WHICH SHALL NOT EXCEED 0.010(0.25) PER SIDE.

8-Pin SOIC (M)

MICREL INC. 2180 FORTUNE DRIVE SAN JOSE, CA 95131 USA  
 TEL + 1 (408) 944-0800 FAX + 1 (408) 474-1000 WEB <http://www.micrel.com>

This information furnished by Micrel in this data sheet is believed to be accurate and reliable. However no responsibility is assumed by Micrel for its use. Micrel reserves the right to change circuitry and specifications at any time without notification to the customer.

Micrel Products are not designed or authorized for use as components in life support appliances, devices or systems where malfunction of a product can reasonably be expected to result in personal injury. Life support devices or systems are devices or systems that (a) are intended for surgical implant into the body or (b) support or sustain life, and whose failure to perform can be reasonably expected to result in a significant injury to the user. A Purchaser's use or sale of Micrel Products for use in life support appliances, devices or systems is a Purchaser's own risk and Purchaser agrees to fully indemnify Micrel for any damages resulting from such use or sale.



Компания «Океан Электроники» предлагает заключение долгосрочных отношений при поставках импортных электронных компонентов на взаимовыгодных условиях!

Наши преимущества:

- Поставка оригинальных импортных электронных компонентов напрямую с производств Америки, Европы и Азии, а так же с крупнейших складов мира;
- Широкая линейка поставок активных и пассивных импортных электронных компонентов (более 30 млн. наименований);
- Поставка сложных, дефицитных, либо снятых с производства позиций;
- Оперативные сроки поставки под заказ (от 5 рабочих дней);
- Экспресс доставка в любую точку России;
- Помощь Конструкторского Отдела и консультации квалифицированных инженеров;
- Техническая поддержка проекта, помощь в подборе аналогов, поставка прототипов;
- Поставка электронных компонентов под контролем ВП;
- Система менеджмента качества сертифицирована по Международному стандарту ISO 9001;
- При необходимости вся продукция военного и аэрокосмического назначения проходит испытания и сертификацию в лаборатории (по согласованию с заказчиком);
- Поставка специализированных компонентов военного и аэрокосмического уровня качества (Xilinx, Altera, Analog Devices, Intersil, Interpoint, Microsemi, Actel, Aeroflex, Peregrine, VPT, Syfer, Eurofarad, Texas Instruments, MS Kennedy, Miteq, Cobham, E2V, MA-COM, Hittite, Mini-Circuits, General Dynamics и др.);

Компания «Океан Электроники» является официальным дистрибьютором и эксклюзивным представителем в России одного из крупнейших производителей разъемов военного и аэрокосмического назначения «**JONHON**», а так же официальным дистрибьютором и эксклюзивным представителем в России производителя высокотехнологичных и надежных решений для передачи СВЧ сигналов «**FORSTAR**».



## JONHON

«**JONHON**» (основан в 1970 г.)

Разъемы специального, военного и аэрокосмического назначения:

(Применяются в военной, авиационной, аэрокосмической, морской, железнодорожной, горно- и нефтедобывающей отраслях промышленности)

«**FORSTAR**» (основан в 1998 г.)

ВЧ соединители, коаксиальные кабели,  
кабельные сборки и микроволновые компоненты:

(Применяются в телекоммуникациях гражданского и специального назначения, в средствах связи, РЛС, а так же военной, авиационной и аэрокосмической отраслях промышленности).



Телефон: 8 (812) 309-75-97 (многоканальный)

Факс: 8 (812) 320-03-32

Электронная почта: [ocean@oceanchips.ru](mailto:ocean@oceanchips.ru)

Web: <http://oceanchips.ru/>

Адрес: 198099, г. Санкт-Петербург, ул. Калинина, д. 2, корп. 4, лит. А