

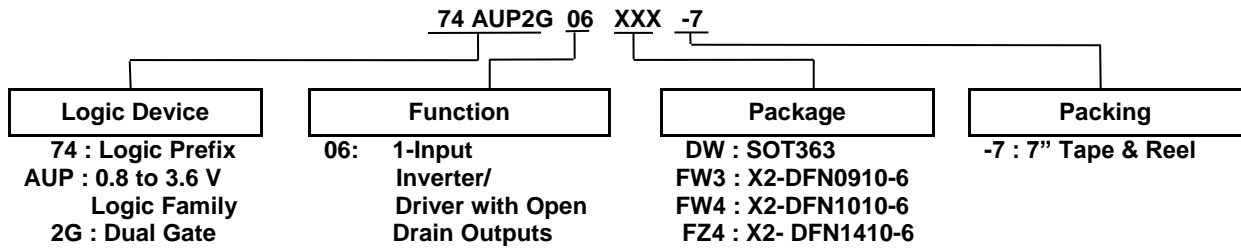

## Ordering Information



Part Number	Package Code	Package (Notes 4,5)	Package Size	7" Tape and Reel	
				Quantity	Part Number Suffix
74AUP2G06DW-7	DW	SOT363	2.0mm X 2.0mm X 1.1mm 0.65 mm lead pitch	3000/Tape & Reel	-7
74AUP2G06FW3-7	FW3	X2-DFN0910-6	0.9mm X 1.0mm X 0.35mm 0.35 mm pad pitch	5000/Tape & Reel	-7
74AUP2G06FW4-7	FW4	X2-DFN1010-6	1.0mm X 1.0mm X 0.4mm 0.35 mm pad pitch	5000/Tape & Reel	-7
74AUP2G06FZ4-7	FZ4	X2-DFN1410-6	1.4mm X 1.0mm X 0.4mm 0.5 mm pad pitch	5000/Tape & Reel	-7

Notes: 4. Pad layout as shown on Diodes Inc. suggested pad layout document AP02001, which can be found on our website at <http://www.diodes.com/datasheets/ap02001.pdf>.  
 5. The taping orientation is located on our website at <http://www.diodes.com/datasheets/ap02007.pdf>.

## Pin Descriptions

Pin Name	Pin NO	Function
1A	1	Data Input
GND	2	Ground
2A	3	Data Input
2Y	4	Data Output
V <sub>CC</sub>	5	Supply Voltage
1Y	6	Data Output

## Logic Diagram

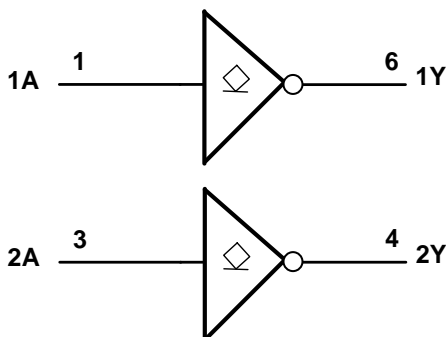

## Function Table

Inputs	Output
nA	nY
H	L
L	Z

**Absolute Maximum Ratings** (Notes 6, 7) (@T<sub>A</sub> = +25°C, unless otherwise specified.)

Symbol	Description	Rating	Unit
ESD HBM	Human Body Model ESD Protection	2	kV
ESD CDM	Charged Device Model ESD Protection	1	kV
ESD MM	Machine Model ESD Protection	200	V
V <sub>CC</sub>	Supply Voltage Range	-0.5 to +4.6	V
V <sub>I</sub>	Input Voltage Range	-0.5 to +4.6	V
V <sub>O</sub>	Voltage Applied to Output in High or Low State	-0.5 to +4.6	V
I <sub>IK</sub>	Input Clamp Current V <sub>I</sub> <0	-50	mA
I <sub>OK</sub>	Output Clamp Current (V <sub>O</sub> < 0)	-50	mA
I <sub>O</sub>	Continuous Output Current (V <sub>O</sub> = 0 to V <sub>CC</sub> )	±20	mA
I <sub>CC</sub>	Continuous Current through V <sub>CC</sub>	50	mA
I <sub>GND</sub>	Continuous Current through GND	-50	mA
T <sub>J</sub>	Operating Junction Temperature	-40 to +150	°C
T <sub>STG</sub>	Storage Temperature	-65 to +150	°C

- Notes:
- Stresses beyond the absolute maximum may result in immediate failure or reduced reliability. These are stress values and device operation should be within recommend values.
  - Forcing the maximum allowed voltage could cause a condition exceeding the maximum current or conversely forcing the maximum current could cause a condition exceeding the maximum voltage. The ratings of both current and voltage must be maintained within the controlled range.

**Recommended Operating Conditions** (Note 8) (@T<sub>A</sub> = +25°C, unless otherwise specified.)

Symbol	Parameter		Min	Max	Unit
V <sub>CC</sub>	Operating Voltage	—	0.8	3.6	V
V <sub>I</sub>	Input Voltage		0	3.6	V
V <sub>O</sub>	Output Voltage		0	3.6	V
I <sub>OL</sub>	Low-Level Output Current	V <sub>CC</sub> = 0.8V	—	20	μA
		V <sub>CC</sub> = 1.1V	—	1.1	mA
		V <sub>CC</sub> = 1.4V	—	1.7	
		V <sub>CC</sub> = 1.65V	—	1.9	
		V <sub>CC</sub> = 2.3V	—	3.1	
		V <sub>CC</sub> = 3.0V	—	4	
Δt/ΔV	Input Transition Rise or Fall Rate	V <sub>CC</sub> = 0.8V to 3.6V	—	200	ns/V
T <sub>A</sub>	Operating Free-Air Temperature	—	-40	+125	°C

- Note:
- Unused inputs should be held at V<sub>CC</sub> or Ground.

**Electrical Characteristics** (@T<sub>A</sub> = +25°C, unless otherwise specified.)

Symbol	Parameter	Test Conditions	V <sub>CC</sub>	T <sub>A</sub> = +25°C		T <sub>A</sub> = -40 to +85°C		Unit
				Min	Max	Min	Max	
V <sub>IH</sub>	High-Level Input Voltage	—	0.8V to 1.65V	0.80 X V <sub>CC</sub>	—	0.80 X V <sub>CC</sub>	—	V
		—	1.65V to 1.95V	0.65 X V <sub>CC</sub>	—	0.65 X V <sub>CC</sub>	—	
		—	2.3V to 2.7V	1.6	—	1.6	—	
		—	3.0V to 3.6V	2.0	—	2.0	—	
V <sub>IL</sub>	Low-Level Input voltage	—	0.8V to 1.65V	—	0.30 X V <sub>CC</sub>	—	0.30 X V <sub>CC</sub>	V
		—	1.65V to 1.95V	—	0.35 X V <sub>CC</sub>	—	0.35 X V <sub>CC</sub>	
		—	2.3V to 2.7V	—	0.7	—	0.7	
		—	3.0V to 3.6V	—	0.9	—	0.9	
V <sub>OL</sub>	Low-Level Output Voltage	I <sub>OL</sub> = 20μA	0.8V to 3.6V	—	0.1	—	0.1	V
		I <sub>OL</sub> = 1.1mA	1.1V	—	0.3 X V <sub>CC</sub>	—	0.3 X V <sub>CC</sub>	
		I <sub>OL</sub> = 1.7mA	1.4V	—	0.31	—	0.37	
		I <sub>OL</sub> = 1.9mA	1.65V	—	0.31	—	0.35	
		I <sub>OL</sub> = 2.3mA	2.3V	—	0.31	—	0.33	
		I <sub>OL</sub> = 3.1mA		—	0.44	—	0.45	
		I <sub>OL</sub> = 2.7mA	3V	—	0.31	—	0.33	
		I <sub>OL</sub> = 4mA		—	0.44	—	0.45	
I <sub>I</sub>	Input Current	A or B Input, V <sub>I</sub> = GND to 3.6V	0V to 3.6V	—	±0.1	—	±0.5	μA
I <sub>OZ</sub>	Z State Leakage Current	V <sub>O</sub> = 3.6V, V <sub>I</sub> = 3.6V	3.6V	—	±0.1	—	±0.5	μA
I <sub>OFF</sub>	Power Down Leakage Current	V <sub>I</sub> or V <sub>O</sub> = 0V to 3.6V	0V	—	±0.2	—	±0.6	μA
ΔI <sub>OFF</sub>	Delta Power Down Leakage Current	V <sub>I</sub> or V <sub>O</sub> = 0V to 3.6V	0V to 0.2V	—	±0.2	—	±0.6	μA
I <sub>CC</sub>	Supply Current	V <sub>I</sub> = GND or V <sub>CC</sub> , I <sub>O</sub> = 0	0.8V to 3.6V	—	0.5	—	0.9	μA
ΔI <sub>CC</sub>	Additional Supply Current	One input at V <sub>CC</sub> -0.6V Other inputs at V <sub>CC</sub> or GND	3.3V	—	40	—	50	μA

**Electrical Characteristics** (@T<sub>A</sub> = +25°C, unless otherwise specified.)

Symbol	Parameter	Test Conditions	V <sub>CC</sub>	T <sub>A</sub> = -40°C to +125°C		Unit
				Min	Max	
V <sub>IH</sub>	High-Level Input Voltage	—	0.8V to 1.65V	0.80 X V <sub>CC</sub>	—	V
		—	1.65V to 1.95V	0.70 X V <sub>CC</sub>	—	
		—	2.3V to 2.7V	1.6	—	
		—	3.0V to 3.6V	2.0	—	
V <sub>IL</sub>	Low-Level Input voltage	—	0.8V to 1.65V	—	0.25 X V <sub>CC</sub>	V
		—	1.65V to 1.95V	—	0.30 X V <sub>CC</sub>	
		—	2.3V to 2.7V	—	0.7	
		—	3.0V to 3.6V	—	0.9	
V <sub>OL</sub>	Low-Level Output Voltage	I <sub>OL</sub> = 20μA	0.8V to 3.6V	—	0.11	V
		I <sub>OL</sub> = 1.1mA	1.1V	—	0.33 X V <sub>CC</sub>	
		I <sub>OL</sub> = 1.7mA	1.4V	—	0.41	
		I <sub>OL</sub> = 1.9mA	1.65V	—	0.39	
		I <sub>OL</sub> = 2.3mA	2.3V	—	0.36	
		I <sub>OL</sub> = 3.1mA		—	0.50	
		I <sub>OL</sub> = 2.7mA	3V	—	0.36	
		I <sub>OL</sub> = 4mA		—	0.50	
I <sub>I</sub>	Input Current	A or B Input, V <sub>I</sub> = GND to 3.6V	0V to 3.6V	—	± 0.75	μA
I <sub>OZ</sub>	Z State Leakage Current	V <sub>O</sub> = 3.6V, V <sub>I</sub> = 3.6V	3.6V	—	± 0.75	μA
I <sub>OFF</sub>	Power Down Leakage Current	V <sub>I</sub> or V <sub>O</sub> = 0V to 3.6V	0V	—	± 0.75	μA
ΔI <sub>OFF</sub>	Delta Power Down Leakage Current	V <sub>I</sub> or V <sub>O</sub> = 0V to 3.6V	0V to 0.2V	—	± 2.5	μA
I <sub>CC</sub>	Supply Current	V <sub>I</sub> = GND or V <sub>CC</sub> , I <sub>O</sub> = 0	0.8V to 3.6V	—	1.4	μA
ΔI <sub>CC</sub>	Additional Supply Current	Input at V <sub>CC</sub> -0.6V Other inputs at V <sub>CC</sub> or GND	3.3V	—	75	μA

**Operating Characteristics** (@T<sub>A</sub> = +25°C, unless otherwise specified.)

Parameter		Test Conditions	V <sub>CC</sub>	Typ	Unit
C <sub>pd</sub>	Power Dissipation Capacitance	f = 1MHz No Load	0.8V	0.5	pF
			1.2V ± 0.1V	0.6	
			1.5V ± 0.1V	0.7	
			1.8V ± 0.15V	0.7	
			2.5V ± 0.2V	1.0	
			3.3V ± 0.3V	1.2	
C <sub>I</sub>	Input Capacitance	V <sub>I</sub> = V <sub>CC</sub> or GND	0V or 3.3V	2.0	pF
C <sub>O</sub>	Output Capacitance	V <sub>O</sub> = V <sub>CC</sub> or GND	0V	2.0	pF

## Switching Characteristics

 $C_L = 5\text{pF}$  see Figure 1

Parameter	From Input	TO OUTPUT	V <sub>CC</sub>	T <sub>A</sub> = +25°C			T <sub>A</sub> = -40°C to +85°C		T <sub>A</sub> = -40°C to +125°C		Unit
				Min	Typ	Max	Min	Max	Min	Max	
t <sub>pd</sub>	A	Y	0.8V	—	12.8	—	—	—	—	—	ns
			1.2V ± 0.1V	2.6	5.8	11.3	2.3	12.5	2.3	15.9	
			1.5V ± 0.1V	1.8	3.6	6.4	1.6	7.4	1.6	8.2	
			1.8V ± 0.15V	1.5	2.9	5	1.4	5.9	1.4	6.5	
			2.5V ± 0.2V	1.2	2.4	3.9	1.1	4.5	1.1	5	
			3.3V ± 0.3V	0.9	3	3.5	0.8	3.9	0.8	4.3	

 $C_L = 10\text{pF}$  see Figure 1

Parameter	From Input	TO OUTPUT	V <sub>CC</sub>	T <sub>A</sub> = +25°C			T <sub>A</sub> = -40°C to +85°C		T <sub>A</sub> = -40°C to +125°C		Unit
				Min	Typ	Max	Min	Max	Min	Max	
t <sub>pd</sub>	A	Y	0.8V	—	14.5	—	—	—	—	—	ns
			1.2V ± 0.1V	3.1	7	13.4	2.9	15.1	2.9	19.2	
			1.5V ± 0.1V	2.3	4.8	7.5	2.1	8.7	2.1	10.5	
			1.8V ± 0.15V	2	3.8	4.8	1.8	7	1.8	7.7	
			2.5V ± 0.2V	1.6	3.1	4.6	1.5	5.4	1.5	6	
			3.3V ± 0.3V	1.2	4.3	4.9	1.1	5.4	1.1	5.9	

 $C_L = 15\text{pF}$  see Figure 1

Parameter	From Input	TO OUTPUT	V <sub>CC</sub>	T <sub>A</sub> = +25°C			T <sub>A</sub> = -40°C to +85°C		T <sub>A</sub> = -40°C to +125°C		Unit
				Min	Typ	Max	Min	Max	Min	Max	
t <sub>pd</sub>	A	Y	0.8V	—	16.2	—	—	—	—	—	ns
			1.2V ± 0.1V	3.5	8.2	14.3	3.3	17.4	3.3	22.5	
			1.5V ± 0.1V	2.6	6.2	8.6	2.4	10.5	2.4	13.7	
			1.8V ± 0.15V	2.3	5	6.7	2.1	8	2.1	9.8	
			2.5V ± 0.2V	2.1	3.9	5.1	1.8	6.1	1.8	6.8	
			3.3V ± 0.3V	1.6	5.6	6.4	1.4	7.1	1.4	7.8	

 $C_L = 30\text{pF}$  see Figure 1

Parameter	From Input	TO OUTPUT	V <sub>CC</sub>	T <sub>A</sub> = +25°C			T <sub>A</sub> = -40°C to +85°C		T <sub>A</sub> = -40°C to +125°C		Unit
				Min	Typ	Max	Min	Max	Min	Max	
t <sub>pd</sub>	A	Y	0.8V	—	19.8	—	—	—	—	—	ns
			1.2V ± 0.1V	4.8	9.8	18.4	4.4	18.4	4.4	25.8	
			1.5V ± 0.1V	3.6	8.2	13.9	3.2	13.9	3.2	18	
			1.8V ± 0.15V	3.2	7.8	12.2	2.9	12.2	2.9	15.2	
			2.5V ± 0.2V	2.4	7.5	9.9	2.6	9.9	2.6	11.4	
			3.3V ± 0.3V	1.8	9.2	10.6	2.1	11.6	2.1	12.8	

**Parameter Measurement Information**

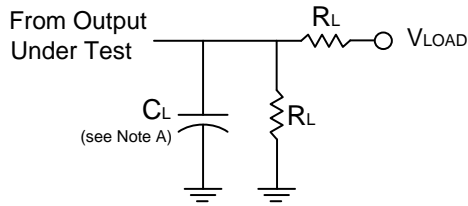

TEST	Condition
$t_{PLZ}$ (See Notes D & E)	Vload
$t_{PZL}$ (See Notes D & F)	Vload

$V_{CC}$	Inputs		$V_M$	$V_{LOAD}$	$C_L$	$R_L$	$V_{\Delta}$
	$V_I$	$t_r/t_f$					
0.8V	$V_{CC}$	$\leq 3$ ns	$V_{CC}/2$	$2 \times V_{CC}$	5, 10, 15, 30pF	5k $\Omega$	0.1V
1.2V $\pm$ 0.1V	$V_{CC}$	$\leq 3$ ns	$V_{CC}/2$	$2 \times V_{CC}$	5, 10, 15, 30pF	5k $\Omega$	0.1V
1.5V $\pm$ 0.1V	$V_{CC}$	$\leq 3$ ns	$V_{CC}/2$	$2 \times V_{CC}$	5, 10, 15, 30pF	5k $\Omega$	0.15V
1.8V $\pm$ 0.15V	$V_{CC}$	$\leq 3$ ns	$V_{CC}/2$	$2 \times V_{CC}$	5, 10, 15, 30pF	5k $\Omega$	0.15V
2.5V $\pm$ 0.2V	$V_{CC}$	$\leq 3$ ns	$V_{CC}/2$	$2 \times V_{CC}$	5, 10, 15, 30pF	5k $\Omega$	0.15V
3.3V $\pm$ 0.3V	$V_{CC}$	$\leq 3$ ns	$V_{CC}/2$	$2 \times V_{CC}$	5, 10, 15, 30pF	5k $\Omega$	0.3V

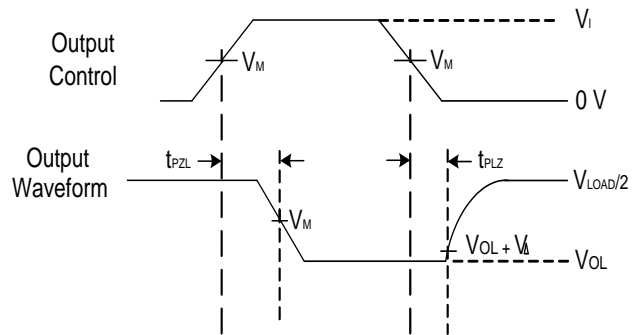
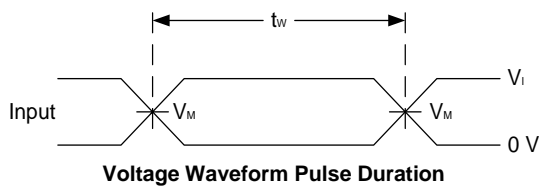

**Voltage Waveform Propagation Delay Times**

**Figure 1 Load Circuit and Voltage Waveforms**

- Notes:
- A. Includes test lead and test apparatus capacitance.
  - B. All pulses are supplied at pulse repetition rate  $\leq 10$ MHz.
  - C. The inputs are measured one at a time with one transition per measurement.
  - D. For the open drain device  $t_{PLZ}$  and  $t_{PZL}$  are the same as  $t_{PD}$ .
  - E.  $t_{PZL}$  is measured at  $V_M$ .
  - D.  $t_{PLZ}$  is measured at  $V_{OL} + V_{\Delta}$ .

**Marking Information**

(1) SOT363

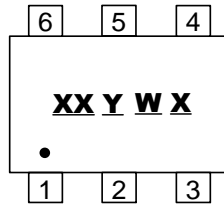

XX : Identification code  
Y : Year 0~9  
W : Week : A~Z : 1~26 week;  
 a~z : 27~52 week; z represents  
 52 and 53 week  
X : A~Z : Internal Code

Part Number	Package	Identification Code
74AUP2G06DW-7	SOT363	SN

(2) X2-DFN1410-6, X2-DFN1010-6, X2-DFN0910-6

(Top View)



XX : Identification Code  
Y : Year : 0~9  
W : Week : A~Z : 1~26 week;  
 a~z : 27~52 week; z represents  
 52 and 53 week  
X : A~Z : Internal code

Part Number	Package	Identification Code
74AUP2G06FZ4	X2-DFN1410-6	RN
74AUP2G06FW4	X2-DFN1010-6	SN
74AUP2G06FW3	X2-DFN0910-6	MN



**SOT363 Package Outline Dimensions and Suggested Pad Layout**

Please see AP02002 at <http://www.diodes.com/datasheets/ap02002.pdf> for the latest version.



SOT363			
Dim	Min	Max	Typ
A	0.10	0.30	0.25
B	1.15	1.35	1.30
C	2.00	2.20	2.10
D	0.65 Typ		
F	0.40	0.45	0.425
H	1.80	2.20	2.15
J	0	0.10	0.05
K	0.90	1.00	1.00
L	0.25	0.40	0.30
M	0.10	0.22	0.11
α	0°	8°	-
All Dimensions in mm			



Dimensions	Value (in mm)
Z	2.5
G	1.3
X	0.42
Y	0.6
C1	1.9
C2	0.65

**X2-DFN0910-6 Package Outline Dimensions and Suggested Pad Layout**

Please see AP02002 at <http://www.diodes.com/datasheets/ap02002.pdf> for the latest version.

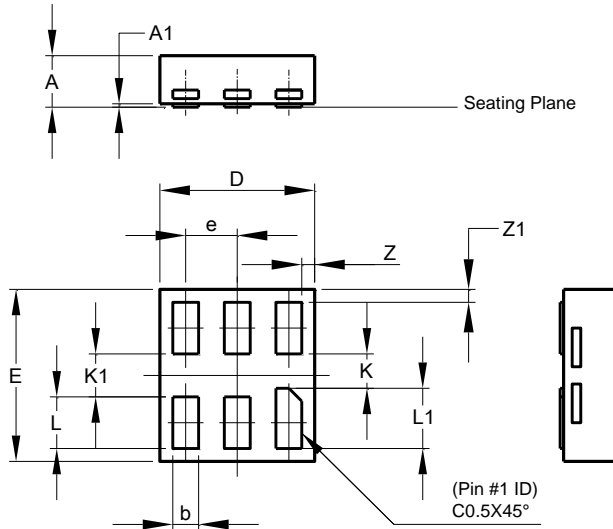

X2-DFN0910-6			
Dim	Min	Max	Typ
A	-	0.35	0.30
A1	0	0.03	0.02
b	0.10	0.20	0.15
D	0.85	0.95	0.90
E	0.95	1.05	1.00
e	-	-	0.30
K	0.20	-	-
K1	0.25	-	-
L	0.25	0.35	0.30
L1	0.30	0.40	0.35
Z	-	-	0.075
Z1	-	-	0.075
All Dimensions in mm			

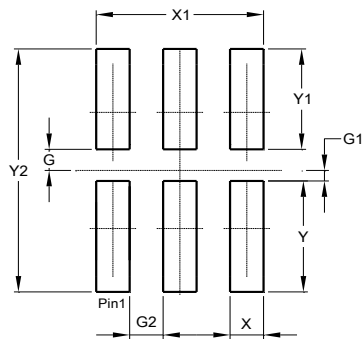

Dimensions	Value (in mm)
G	0.100
G1	0.050
G2	0.150
X	0.150
X1	0.750
Y	0.525
Y1	0.475
Y2	1.150

**X2-DFN1010-6 Package Outline Dimensions and Suggested Pad Layout**

Please see AP02002 at <http://www.diodes.com/datasheets/ap02002.pdf> for the latest version.



X2-DFN1010-6			
Dim	Min	Max	Typ
A	—	0.40	0.39
A1	0.00	0.05	0.02
A3	—	—	0.13
b	0.14	0.20	0.17
b1	0.05	0.15	0.10
D	0.95	1.05	1.00
E	0.95	1.05	1.00
e	—	—	0.35
L	0.35	0.45	0.40
K	0.15	—	—
Z	—	—	0.065
All Dimensions in mm			



Dimensions	Value (in mm)
C	0.350
G	0.150
G1	0.150
X	0.200
X1	0.900
Y	0.500
Y1	0.525
Y2	0.475
Y3	1.150

**X2-DFN1410-6 Package Outline Dimensions and Suggested Pad Layout**

Please see AP02002 at <http://www.diodes.com/datasheets/ap02002.pdf> for the latest version.



X2-DFN1410-6			
Dim	Min	Max	Typ
A	—	0.40	0.39
A1	0.00	0.05	0.02
A3	—	—	0.13
b	0.15	0.25	0.20
D	1.35	1.45	1.40
E	0.95	1.05	1.00
e	—	—	0.50
L	0.25	0.35	0.30
Z	—	—	0.10
Z1	0.045	0.105	0.075
All Dimensions in mm			



Dimensions	Value (in mm)
C	0.500
G	0.250
X	0.250
X1	1.250
Y	0.525
Y1	1.250

**IMPORTANT NOTICE**

DIODES INCORPORATED MAKES NO WARRANTY OF ANY KIND, EXPRESS OR IMPLIED, WITH REGARDS TO THIS DOCUMENT, INCLUDING, BUT NOT LIMITED TO, THE IMPLIED WARRANTIES OF MERCHANTABILITY AND FITNESS FOR A PARTICULAR PURPOSE (AND THEIR EQUIVALENTS UNDER THE LAWS OF ANY JURISDICTION).

Diodes Incorporated and its subsidiaries reserve the right to make modifications, enhancements, improvements, corrections or other changes without further notice to this document and any product described herein. Diodes Incorporated does not assume any liability arising out of the application or use of this document or any product described herein; neither does Diodes Incorporated convey any license under its patent or trademark rights, nor the rights of others. Any Customer or user of this document or products described herein in such applications shall assume all risks of such use and will agree to hold Diodes Incorporated and all the companies whose products are represented on Diodes Incorporated website, harmless against all damages.

Diodes Incorporated does not warrant or accept any liability whatsoever in respect of any products purchased through unauthorized sales channel.

Should Customers purchase or use Diodes Incorporated products for any unintended or unauthorized application, Customers shall indemnify and hold Diodes Incorporated and its representatives harmless against all claims, damages, expenses, and attorney fees arising out of, directly or indirectly, any claim of personal injury or death associated with such unintended or unauthorized application.

Products described herein may be covered by one or more United States, international or foreign patents pending. Product names and markings noted herein may also be covered by one or more United States, international or foreign trademarks.

This document is written in English but may be translated into multiple languages for reference. Only the English version of this document is the final and determinative format released by Diodes Incorporated.

**LIFE SUPPORT**

Diodes Incorporated products are specifically not authorized for use as critical components in life support devices or systems without the express written approval of the Chief Executive Officer of Diodes Incorporated. As used herein:

A. Life support devices or systems are devices or systems which:

1. are intended to implant into the body, or
2. support or sustain life and whose failure to perform when properly used in accordance with instructions for use provided in the labeling can be reasonably expected to result in significant injury to the user.

B. A critical component is any component in a life support device or system whose failure to perform can be reasonably expected to cause the failure of the life support device or to affect its safety or effectiveness.

Customers represent that they have all necessary expertise in the safety and regulatory ramifications of their life support devices or systems, and acknowledge and agree that they are solely responsible for all legal, regulatory and safety-related requirements concerning their products and any use of Diodes Incorporated products in such safety-critical, life support devices or systems, notwithstanding any devices- or systems-related information or support that may be provided by Diodes Incorporated. Further, Customers must fully indemnify Diodes Incorporated and its representatives against any damages arising out of the use of Diodes Incorporated products in such safety-critical, life support devices or systems.

Copyright © 2014, Diodes Incorporated

[www.diodes.com](http://www.diodes.com)

Компания «Океан Электроники» предлагает заключение долгосрочных отношений при поставках импортных электронных компонентов на взаимовыгодных условиях!

Наши преимущества:

- Поставка оригинальных импортных электронных компонентов напрямую с производств Америки, Европы и Азии, а так же с крупнейших складов мира;
- Широкая линейка поставок активных и пассивных импортных электронных компонентов (более 30 млн. наименований);
- Поставка сложных, дефицитных, либо снятых с производства позиций;
- Оперативные сроки поставки под заказ (от 5 рабочих дней);
- Экспресс доставка в любую точку России;
- Помощь Конструкторского Отдела и консультации квалифицированных инженеров;
- Техническая поддержка проекта, помощь в подборе аналогов, поставка прототипов;
- Поставка электронных компонентов под контролем ВП;
- Система менеджмента качества сертифицирована по Международному стандарту ISO 9001;
- При необходимости вся продукция военного и аэрокосмического назначения проходит испытания и сертификацию в лаборатории (по согласованию с заказчиком);
- Поставка специализированных компонентов военного и аэрокосмического уровня качества (Xilinx, Altera, Analog Devices, Intersil, Interpoint, Microsemi, Actel, Aeroflex, Peregrine, VPT, Syfer, Eurofarad, Texas Instruments, MS Kennedy, Miteq, Cobham, E2V, MA-COM, Hittite, Mini-Circuits, General Dynamics и др.);

Компания «Океан Электроники» является официальным дистрибьютором и эксклюзивным представителем в России одного из крупнейших производителей разъемов военного и аэрокосмического назначения «JONHON», а так же официальным дистрибьютором и эксклюзивным представителем в России производителя высокотехнологичных и надежных решений для передачи СВЧ сигналов «FORSTAR».



## JONHON

«JONHON» (основан в 1970 г.)

Разъемы специального, военного и аэрокосмического назначения:

(Применяются в военной, авиационной, аэрокосмической, морской, железнодорожной, горно- и нефтедобывающей отраслях промышленности)

«FORSTAR» (основан в 1998 г.)

ВЧ соединители, коаксиальные кабели, кабельные сборки и микроволновые компоненты:

(Применяются в телекоммуникациях гражданского и специального назначения, в средствах связи, РЛС, а так же военной, авиационной и аэрокосмической отраслях промышленности).



Телефон: 8 (812) 309-75-97 (многоканальный)

Факс: 8 (812) 320-03-32

Электронная почта: [ocean@oceanchips.ru](mailto:ocean@oceanchips.ru)

Web: <http://oceanchips.ru/>

Адрес: 198099, г. Санкт-Петербург, ул. Калинина, д. 2, корп. 4, лит. А