

# LDC15F

LD C 15 F -1 -□

① ② ③ ④ ⑤ ⑥



RoHS

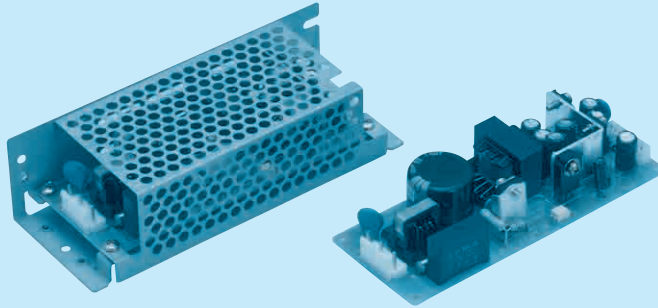

- ① Series name
- ② Multiple output
- ③ Output wattage
- ④ Universal input
- ⑤ Output voltage combination
- ⑥ Optional \*4  
 C :with Coating  
 G :Low leakage current  
 S :with Chassis  
 SN :with Chassis & cover  
 Y :with Potentiometer

LDC

MODEL	LDC15F-1		LDC15F-2	
DC OUTPUT	V1	+5V 2.0(Peak 3.0)A	+5V 2.0(Peak 3.0)A	
	V2	+12V 0.3(Peak 0.6)A	+15V 0.3(Peak 0.6)A	
	V3	-12V 0.2(Peak 0.3)A	-15V 0.2(Peak 0.3)A	

## SPECIFICATIONS

	MODEL	LDC15F-1			LDC15F-2			
INPUT	VOLTAGE[V]	AC85 - 264 1 φ or DC110 - 370						
	CURRENT[A]	ACIN 100V	0.4typ (Io=100%)					
	FREQUENCY[Hz]	47 - 440 or DC						
	EFFICIENCY[%]	ACIN 100V	70typ (Io=100%)					
	INRUSH CURRENT[A]	ACIN 100V	25typ (Io=100%)					
		ACIN 200V	50typ (Io=100%)					
LEAKAGE CURRENT[ma]	0.75max (60Hz, According to UL, CSA, VDE and DEN-AN)							
OUTPUT	VOLTAGE[V]	+5	+12	-12	+5	+15	-15	
	CURRENT[A]	*1 0 - 2.0 (Peak 3.0)	0 - 0.3 (Peak 0.6)	0 - 0.2 (Peak 0.3)	0 - 2.0 (Peak 3.0)	0 - 0.3 (Peak 0.6)	0 - 0.2 (Peak 0.3)	
	LINE REGULATION[mV]	20max	48max	48max	20max	60max	60max	
	LOAD REGULATION[mV]	100max	120max	120max	100max	150max	150max	
	RIPPLE[mVp-p]	0 to +50°C *2	100max	120max	120max	100max	120max	120max
		-10 - 0°C *2	140max	160max	160max	140max	160max	160max
	RIPPLE NOISE[mVp-p]	0 to +50°C *2	120max	150max	150max	120max	150max	150max
		-10 - 0°C *2	160max	180max	180max	160max	180max	180max
	TEMPERATURE REGULATION[mV]	0 to +50°C	50max	350max	350max	50max	350max	350max
		-10 to +50°C	60max	420max	420max	60max	420max	420max
	DRIFT[mV]	*3 20max	—	—	20max	—	—	
	START-UP TIME[ms]	100max (ACIN 85V, Io=100%)						
	HOLD-UP TIME[ms]	10typ (ACIN 85V, Io=100%), 20typ (ACIN 100V, Io=100%), 100typ (ACIN 200V, Io=100%)						
OUTPUT VOLTAGE ADJUSTMENT RANGE[V]	Fixed	Fixed	Fixed	Fixed	Fixed	Fixed		
OUTPUT VOLTAGE SETTING[V]	4.9 to 5.3	11.4 to 12.6	-11.4 to -12.6	4.9 to 5.3	14.25 to 15.75	-14.25 to -15.75		
PROTECTION CIRCUIT AND OTHERS	OVERCURRENT PROTECTION	Works over 105% of rating and recovers automatically						
	OVERVOLTAGE PROTECTION	Works over 115% of rating by zener diode clamping (+5V only)						
	OPERATING INDICATION	Not provided						
	REMOTE SENSING	Not provided						
ISOLATION	REMOTE ON/OFF	Not provided						
	INPUT-OUTPUT	AC3,000V 1minute, Cutoff current = 10mA, DC500V 50MΩ min (At Room Temperature)						
	INPUT-FG	AC2,000V 1minute, Cutoff current = 10mA, DC500V 50MΩ min (At Room Temperature)						
	OUTPUT-FG	AC500V 1minute, Cutoff current = 100mA, DC500V 50MΩ min (At Room Temperature)						
ENVIRONMENT	OUTPUT-OUTPUT(V1-V2,V3)	AC100V 1minute, Cutoff current = 100mA, DC100V 10MΩ min (At Room Temperature)						
	OPERATING TEMP.,HUMID.AND ALTITUDE	-10 to +60°C, 20 - 90%RH (Non condensing) (Refer to DERATING CURVE), 3,000m (10,000feet)						
	STORAGE TEMP.,HUMID.AND ALTITUDE	-20 to +75°C, 20 - 90%RH (Non condensing), 9,000m (30,000feet)						
	VIBRATION	10 - 55Hz, 19.6m/s <sup>2</sup> (2G), 3minutes period, 60minutes each along X, Y and Z axis						
SAFETY AND NOISE REGULATIONS	IMPACT	196.1m/s <sup>2</sup> (20G), 11ms, once each X, Y and Z axis						
	AGENCY APPROVALS	UL60950-1, EN60950-1, EN50178, CSA C22.2 No.60950-1 Complies with DEN-AN and IEC60950-1						
	CONDUCTED NOISE	Complies with FCC-B, CISPR22-B, EN55022-B, VCCI-B						
OTHERS	CASE SIZE/WEIGHT	50 X 26 X 127mm [1.97 X 1.02 X 5 inches] (W X H X D) /150g max (with chassis & cover : 300g max)						
	COOLING METHOD	Convection						

\*1 Peak load for 10sec. or less is acceptable if the total wattage is less than the rated wattage(-1: 16W, -2: 17.5W).When the load of +5V is OA, other output can be drawn by 80% of rated current.  
 \*2 Measured by 20MHz oscilloscope or Ripple-Noise meter (equivalent to KEISOKU-GIKEN:RM101).  
 \*3 Drift is the change in DC output for an eight hour period after a half-hour warm-up at 25°C with the input voltage held constant at the rated input/output.  
 \*4 Please contact us about safety approvals for the model with option.  
 \* Avoid prolonged use under over-load.  
 \* Derating is required when operated with chassis and cover.

## External view

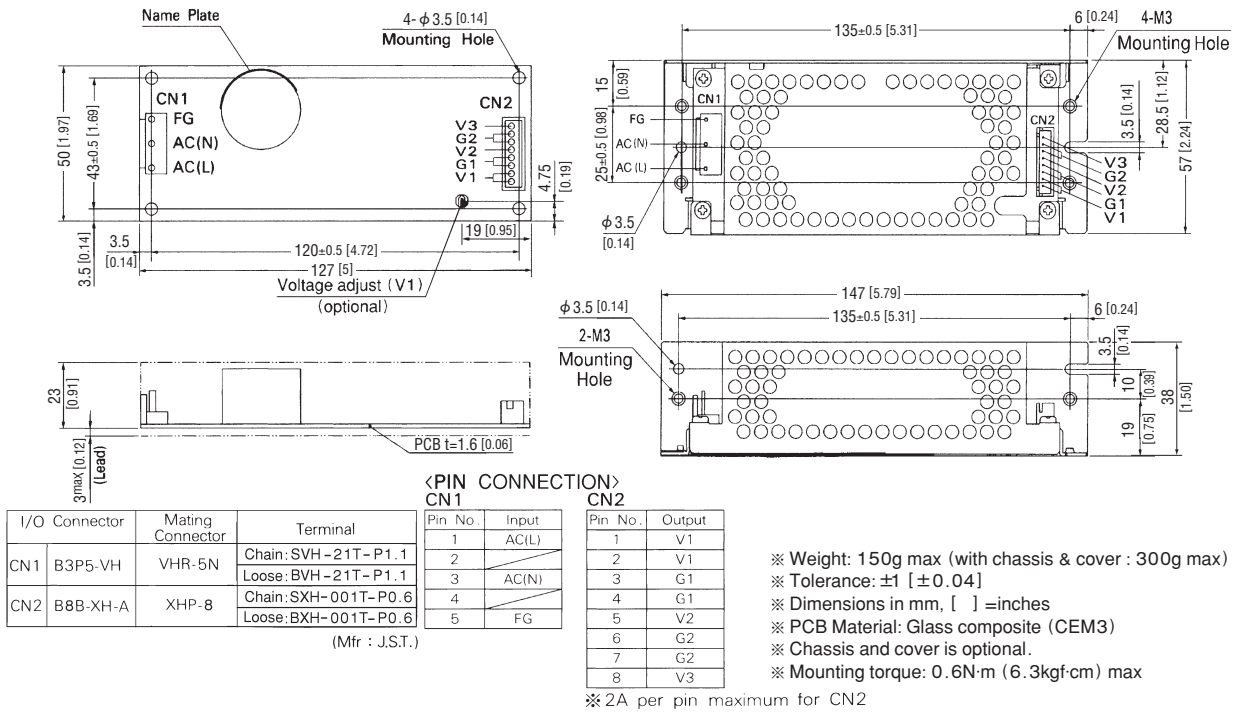

## Performance data

### ■ STATIC CHARACTERISTICS (LDC15F-1)

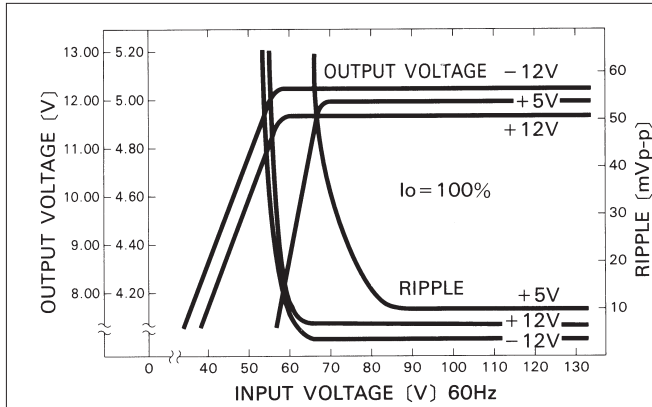

### ■ RISE TIME & FALL TIME (LDC15F-1)

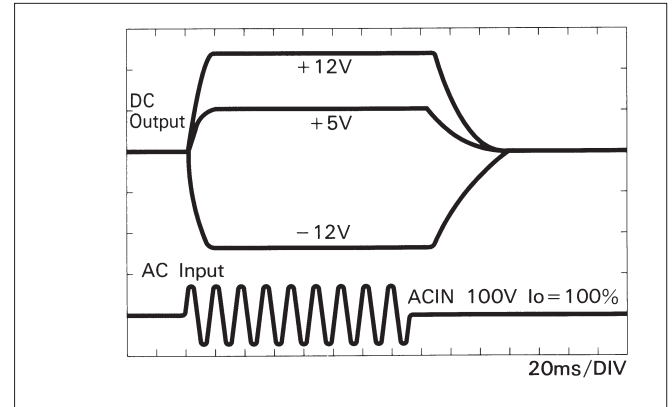

### ■ OVERCURRENT CHARACTERISTICS (LDC15F-1)

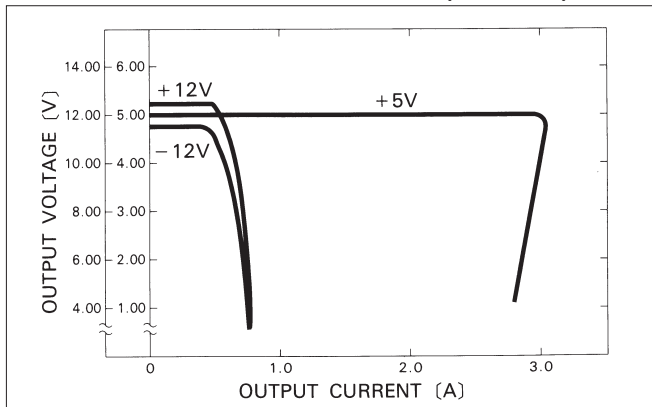

### ■ DERATING CURVE

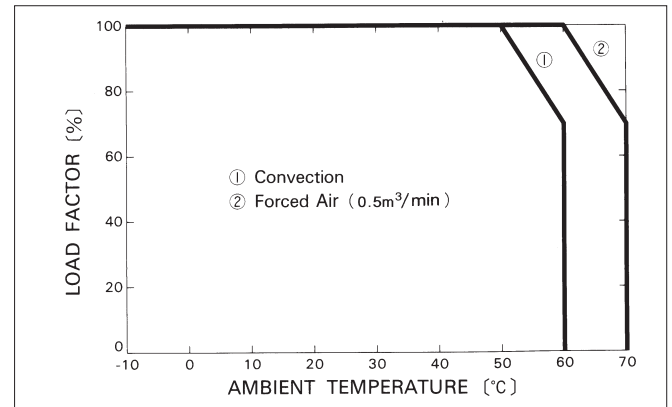

# LDC30F

LD C 30 F -1 -□

① ② ③ ④ ⑤ ⑥



RoHS

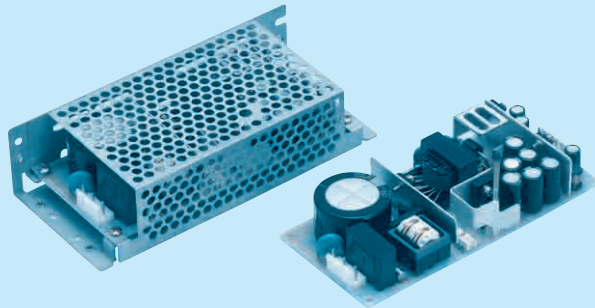

- ① Series name
- ② Multiple output
- ③ Output wattage
- ④ Universal input
- ⑤ Output voltage combination
- ⑥ Optional \*4  
 C :with Coating  
 G :Low leakage current  
 S :with Chassis  
 SN :with Chassis & cover  
 Y :with Potentiometer

LDC

MODEL	LDC30F-1		LDC30F-2	
DC OUTPUT	V1	+5V 3.0(Peak 4.5)A	+5V 3.0(Peak 4.5)A	
	V2	+12V 1.2(Peak 2.0)A	+15V 1.0(Peak 2.0)A	
	V3	-12V 0.3(Peak 0.45)A	-15V 0.3(Peak 0.45)A	

## SPECIFICATIONS

	MODEL	LDC30F-1			LDC30F-2			
INPUT	VOLTAGE[V]	AC85 - 264 1φ or DC110 - 370						
	CURRENT[A]	ACIN 100V	0.8typ (Io=100%)					
	FREQUENCY[Hz]	47 - 440 or DC						
	EFFICIENCY[%]	ACIN 100V	72typ (Io=100%)					
	INRUSH CURRENT[A]	ACIN 100V	25typ (Io=100%) (At cold start)					
		ACIN 200V	50typ (Io=100%) (At cold start)					
LEAKAGE CURRENT[ma]	0.75max (60Hz, According to UL, CSA, VDE and DEN-AN)							
OUTPUT	VOLTAGE[V]	+5	+12	-12	+5	+15	-15	
	CURRENT[A]	*1 0 - 3.0 (Peak 4.5)	0 - 1.2 (Peak 2.0)	0 - 0.3 (Peak 0.45)	0 - 3.0 (Peak 4.5)	0 - 1.0 (Peak 2.0)	0 - 0.3 (Peak 0.45)	
	LINE REGULATION[mV]	20max	48max	48max	20max	60max	60max	
	LOAD REGULATION[mV]	100max	120max	150max	100max	120max	150max	
	RIPPLE[mVp-p]	0 to +50°C *2	100max	120max	120max	100max	120max	120max
		-10 - 0°C *2	150max	160max	160max	150max	160max	160max
	RIPPLE NOISE[mVp-p]	0 to +50°C *2	120max	150max	150max	120max	150max	150max
		-10 - 0°C *2	170max	180max	180max	170max	180max	180max
	TEMPERATURE REGULATION[mV]	0 to +50°C	50max	350max	350max	50max	350max	350max
		-10 to +50°C	60max	420max	420max	60max	420max	420max
	DRIFT[mV]	*3 20max	—	—	20max	—	—	
	START-UP TIME[ms]	100max (ACIN 85V, Io=100%)						
	HOLD-UP TIME[ms]	10typ (ACIN 85V, Io=100%), 20typ (ACIN 100V, Io=100%), 100typ (ACIN 200V, Io=100%)						
OUTPUT VOLTAGE ADJUSTMENT RANGE[V]	Fixed	Fixed	Fixed	Fixed	Fixed	Fixed		
OUTPUT VOLTAGE SETTING[V]	4.9 to 5.3	11.4 to 12.6	-11.4 to -12.6	4.9 to 5.3	14.25 to 15.75	-14.25 to -15.75		
PROTECTION CIRCUIT AND OTHERS	OVERCURRENT PROTECTION	Works over 105% of rating and recovers automatically						
	OVERVOLTAGE PROTECTION	Works at 115 - 140% of rating (+5V only)						
	OPERATING INDICATION	Not provided						
	REMOTE SENSING	Not provided						
ISOLATION	REMOTE ON/OFF	Not provided						
	INPUT-OUTPUT	AC3,000V 1minute, Cutoff current = 10mA, DC500V 50MΩ min (At Room Temperature)						
	INPUT-FG	AC2,000V 1minute, Cutoff current = 10mA, DC500V 50MΩ min (At Room Temperature)						
	OUTPUT-FG	AC500V 1minute, Cutoff current = 100mA, DC500V 50MΩ min (At Room Temperature)						
ENVIRONMENT	OUTPUT-OUTPUT(V1-V2,V3)	AC100V 1minute, Cutoff current = 100mA, DC100V 10MΩ min (At Room Temperature)						
	OPERATING TEMP.,HUMID.AND ALTITUDE	-10 to +60°C, 20 - 90%RH (Non condensing) (Refer to DERATING CURVE), 3,000m (10,000feet)						
	STORAGE TEMP.,HUMID.AND ALTITUDE	-20 to +75°C, 20 - 90%RH (Non condensing), 9,000m (30,000feet)						
	VIBRATION	10 - 55Hz, 19.6m/s <sup>2</sup> (2G), 3minutes period, 60minutes each along X, Y and Z axis						
SAFETY AND NOISE REGULATIONS	IMPACT	196.1m/s <sup>2</sup> (20G), 11ms, once each X, Y and Z axis						
	AGENCY APPROVALS	UL60950-1, EN60950-1, EN50178, CSA C22.2 No.60950-1 Complies with DEN-AN and IEC60950-1						
	CONDUCTED NOISE	Complies with FCC-B, CISPR22-B, EN55022-B, VCCI-B						
OTHERS	CASE SIZE/WEIGHT	65 x 26 x 140mm [2.56 x 1.02 x 5.51 inches] (W x H x D) / 220g max (with chassis & cover : 400g max)						
	COOLING METHOD	Convection						

\*1 Peak load for 10sec. or less is acceptable if the total wattage is less than the rated wattage(-1: 33W, -2: 34.5W).When the load of +5V is OA, other output can be drawn by 80% of rated current.  
 \*2 Measured by 20MHz oscilloscope or Ripple-Noise meter (equivalent to KEISOKU-GIKEN:RM101).  
 \*3 Drift is the change in DC output for an eight hour period after a half-hour warm-up at 25°C with the input voltage held constant at the rated input/output.  
 \*4 Please contact us about safety approvals for the model with option.  
 \* Avoid prolonged use under over-load.  
 \* Derating is required when operated with chassis and cover.

## External view

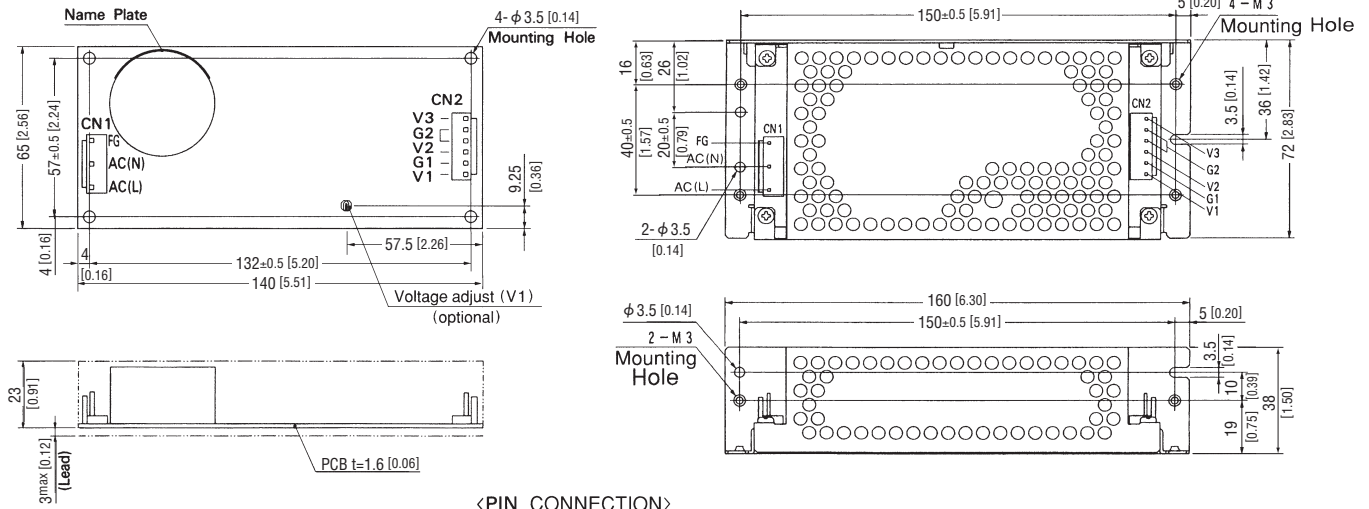

LDC

### <PIN CONNECTION>

I/O Connector	Mating Connector	Terminal	
CN1	B3P5-VH	VHR-5N	Chain:SVH-21T-P1.1
			Loose:BVH-21T-P1.1
CN2	B6P-VH	VHR-6N	Chain:SVH-21T-P1.1
			Loose:BVH-21T-P1.1

(Mfr : J.S.T.)

CN1	
Pin No.	Input
1	AC(L)
2	
3	AC(N)
4	
5	FG

CN2	
Pin No.	Output
1	V3
2	G2
3	G2
4	V2
5	G1
6	V1

- ※ Weight: 220g max (with chassis & cover : 400g max)
- ※ Tolerance:  $\pm 1$  [ $\pm 0.04$ ]
- ※ Dimensions in mm, [ ] =inches
- ※ PCB Material: Glass composite (CEM3)
- ※ Chassis and cover is optional.
- ※ Mounting torque: 0.6N·m (6.3kgf·cm) max

## Performance data

### ■STATIC CHARACTERISTICS (LDC30F-1)

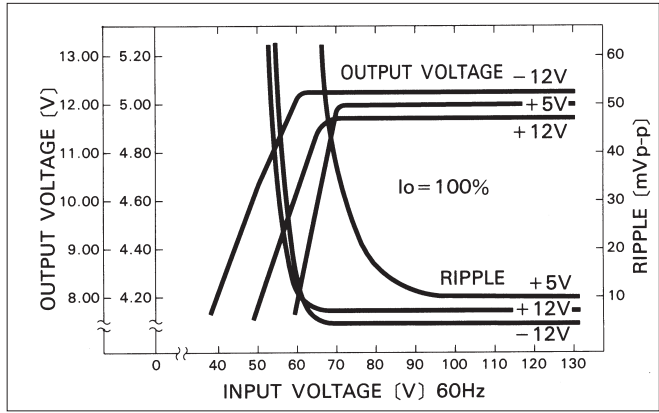

### ■RISE TIME & FALL TIME (LDC30F-1)

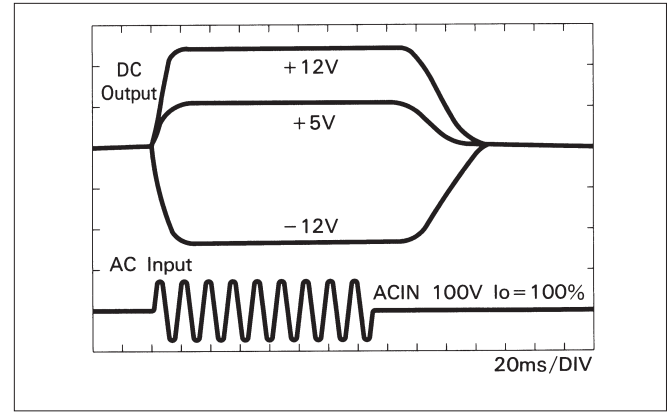

### ■OVERCURRENT CHARACTERISTICS (LDC30F-1)

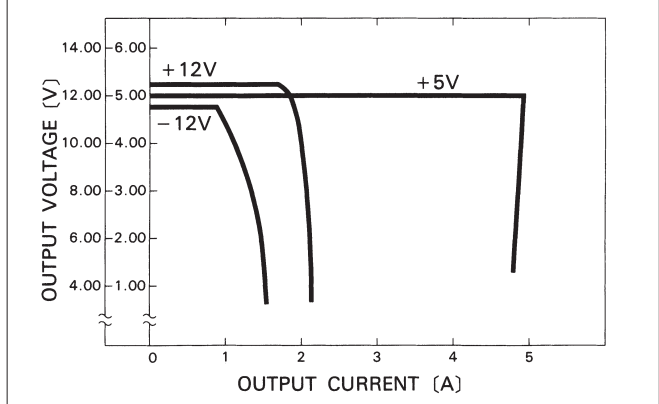

### ■DERATING CURVE

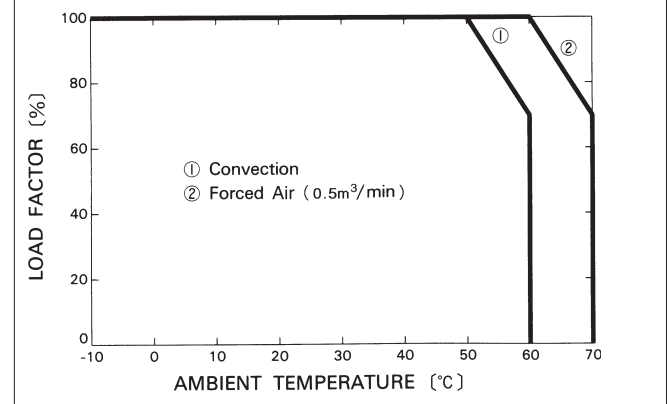

# LDC60F

LD C 60 F -1 -□

① ② ③ ④ ⑤ ⑥



RoHS

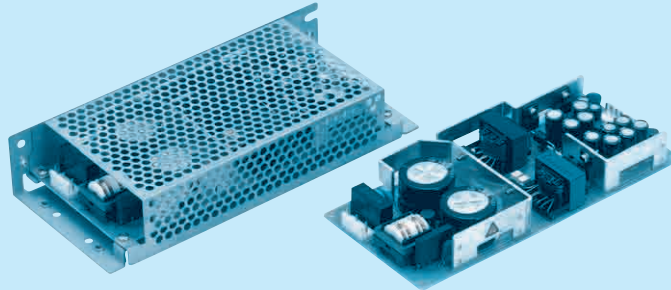

- ① Series name
- ② Multiple output
- ③ Output wattage
- ④ Universal input
- ⑤ Output voltage combination
- ⑥ Optional \*4  
 C :with Coating  
 G :Low leakage current  
 S :with Chassis  
 SN :with Chassis & cover  
 Y :with Potentiometer

LDC

MODEL	LDC60F-1	LDC60F-2
DC OUTPUT	V1 +5V 5.0(Peak 7.0)A V2 +12V 2.5(Peak 3.5)A V3 -12V 0.5(Peak 0.7)A	+5V 5.0(Peak 7.0)A +15V 2.0(Peak 3.5)A -15V 0.5(Peak 0.7)A

## SPECIFICATIONS

	MODEL	LDC60F-1	LDC60F-2					
INPUT	VOLTAGE[V]	AC85 - 264 1φ or DC110 - 370						
	CURRENT[A]	ACIN 100V	1.4typ (Io=100%)					
	FREQUENCY[Hz]		47 - 440 or DC					
	EFFICIENCY[%]	ACIN 100V	72typ (Io=100%)					
	INRUSH CURRENT[A]	ACIN 100V	30typ (Io=100%) (At cold start)					
		ACIN 200V	60typ (Io=100%) (At cold start)					
LEAKAGE CURRENT[ma]		0.75max (60Hz, According to UL, CSA, VDE and DEN-AN)						
OUTPUT	VOLTAGE[V]	+5	+12	-12	+5	+15	-15	
	CURRENT[A]	*1 0 - 5.0 (Peak 7.0)	0 - 2.5 (Peak 3.5)	0 - 0.5 (Peak 0.7)	0 - 5.0 (Peak 7.0)	0 - 2.0 (Peak 3.5)	0 - 0.5 (Peak 0.7)	
	LINE REGULATION[mV]	20max	48max	48max	20max	60max	60max	
	LOAD REGULATION[mV]	100max	150max	150max	100max	150max	150max	
	RIPPLE[mVp-p]	0 to +50°C *2	100max	120max	120max	100max	120max	120max
		-10 - 0°C *2	150max	160max	160max	150max	160max	160max
	RIPPLE NOISE[mVp-p]	0 to +50°C *2	120max	150max	150max	120max	150max	150max
		-10 - 0°C *2	170max	180max	180max	170max	180max	180max
	TEMPERATURE REGULATION[mV]	0 to +50°C	50max	350max	350max	50max	350max	350max
		-10 to +50°C	60max	420max	420max	60max	420max	420max
	DRIFT[mV]	*3 20max	—	—	20max	—	—	
	START-UP TIME[ms]	200max (ACIN 85V, Io=100%)			100typ (ACIN 85V, Io=100%), 20typ (ACIN 100V, Io=100%), 100typ (ACIN 200V, Io=100%)			
	HOLD-UP TIME[ms]	10typ (ACIN 85V, Io=100%), 20typ (ACIN 100V, Io=100%), 100typ (ACIN 200V, Io=100%)						
OUTPUT VOLTAGE ADJUSTMENT RANGE[V]	Fixed	Fixed	Fixed	Fixed	Fixed	Fixed		
OUTPUT VOLTAGE SETTING[V]	4.9 to 5.3	11.4 to 12.6	-11.4 to -12.6	4.9 to 5.3	14.25 to 15.75	-14.25 to -15.75		
PROTECTION CIRCUIT AND OTHERS	OVERCURRENT PROTECTION	Works over 105% of rating and recovers automatically						
	OVERVOLTAGE PROTECTION	Works over 115% of rating by zener diode clamping (only available with V1, V2)						
	OPERATING INDICATION	Not provided						
	REMOTE SENSING	Not provided						
ISOLATION	REMOTE ON/OFF	Not provided						
	INPUT-OUTPUT	AC3.000V 1minute, Cutoff current = 10mA, DC500V 50MΩ min (At Room Temperature)						
	INPUT-FG	AC2.000V 1minute, Cutoff current = 10mA, DC500V 50MΩ min (At Room Temperature)						
	OUTPUT-FG	AC500V 1minute, Cutoff current = 100mA, DC500V 50MΩ min (At Room Temperature)						
ENVIRONMENT	OUTPUT-OUTPUT(V1-V2,V3)	AC100V 1minute, Cutoff current = 100mA, DC100V 10MΩ min (At Room Temperature)						
	OPERATING TEMP.,HUMID.AND ALTITUDE	-10 to +60°C, 20 - 90%RH (Non condensing) (Refer to DERATING CURVE), 3,000m (10,000feet)						
	STORAGE TEMP.,HUMID.AND ALTITUDE	-20 to +75°C, 20 - 90%RH (Non condensing), 9,000m (30,000feet)						
	VIBRATION	10 - 55Hz, 19.6m/s <sup>2</sup> (2G), 3minutes period, 60minutes each along X, Y and Z axis						
SAFETY AND NOISE REGULATIONS	IMPACT	196.1m/s <sup>2</sup> (20G), 11ms, once each X, Y and Z axis						
	AGENCY APPROVALS	UL60950-1, EN60950-1, EN50178, CSA C22.2 No.60950-1 Complies with DEN-AN and IEC60950-1						
	CONDUCTED NOISE	Complies with FCC-B, CISPR22-B, EN55022-B, VCCI-B						
OTHERS	CASE SIZE/WEIGHT	83 x 26 x 185mm [3.27 x 1.02 x 7.28 inches] (W x H x D) / 300g max (with chassis & cover : 550g max)						
	COOLING METHOD	Convection						

\*1 Peak load for 10sec. or less is acceptable if the total wattage is less than the rated wattage(-1: 61W, -2: 62.5W).When the load of +5V is OA, other output can be drawn by 80% of rated current.  
 \*2 Measured by 20MHz oscilloscope or Ripple-Noise meter (equivalent to KEISOKU-GIKEN:RM101).  
 \*3 Drift is the change in DC output for an eight hour period after a half-hour warm-up at 25°C with the input voltage held constant at the rated input/output.  
 \*4 Please contact us about safety approvals for the model with option.  
 \* Avoid prolonged use under over-load.  
 \* Derating is required when operated with chassis and cover.



## External view

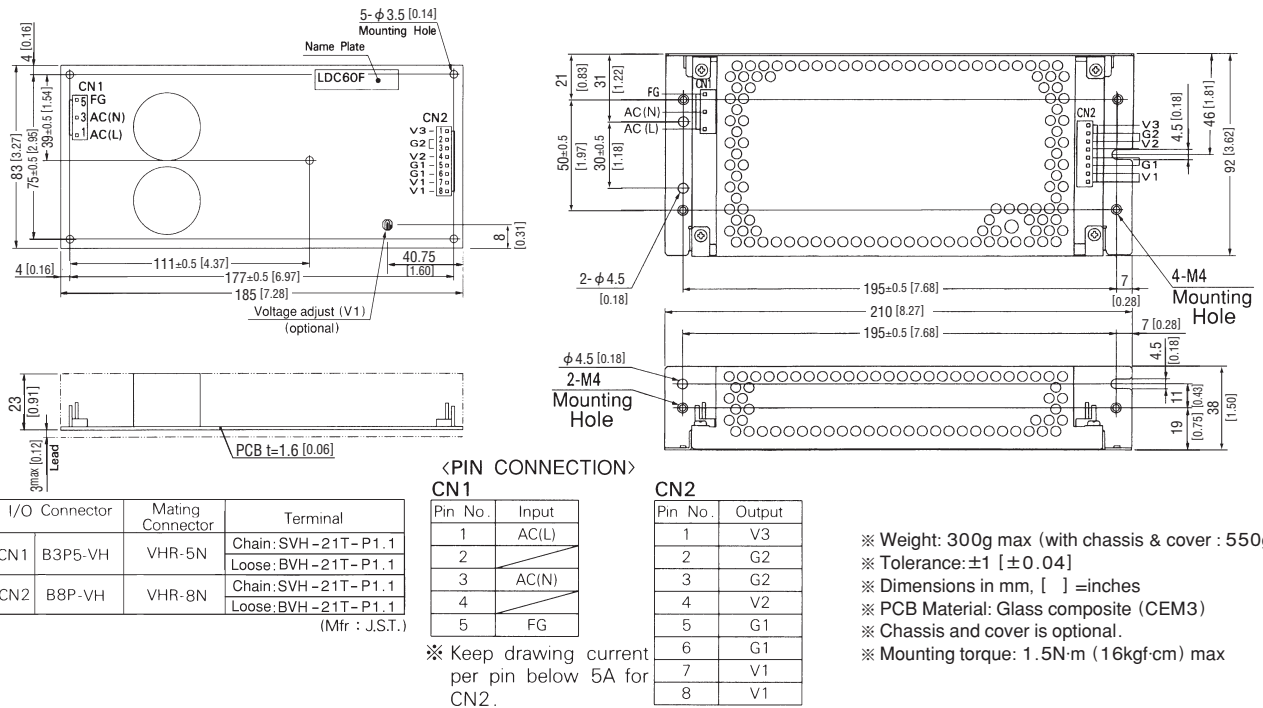

## Performance data

### ■STATIC CHARACTERISTICS (LDC60F-1)

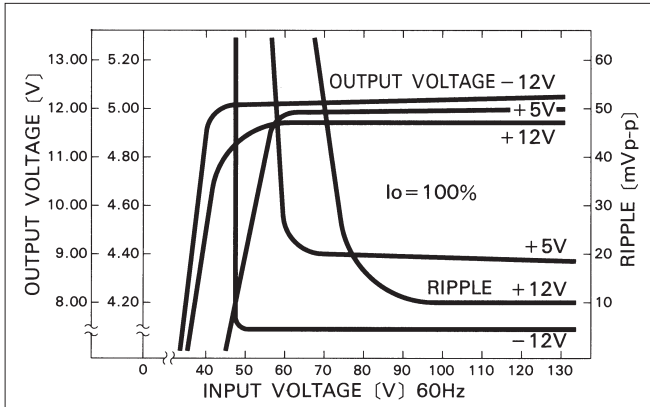

### ■RISE TIME & FALL TIME (LDC60F-1)

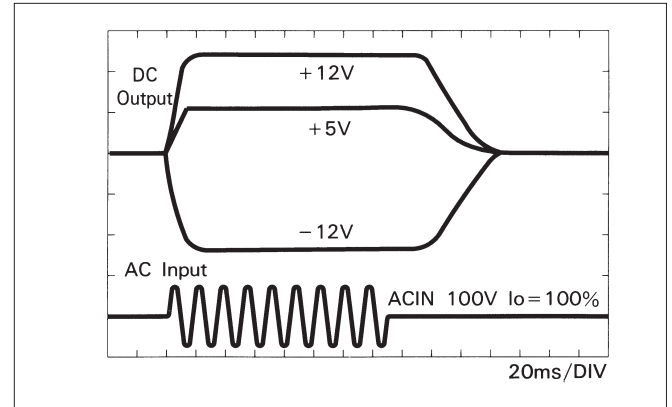

### ■OVERCURRENT CHARACTERISTICS (LDC60F-1)

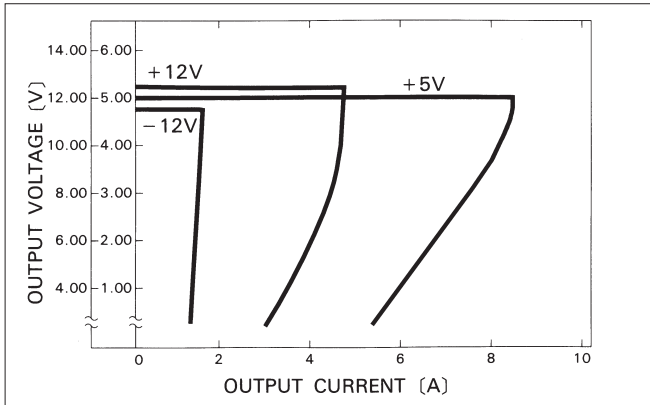

### ■DERATING CURVE

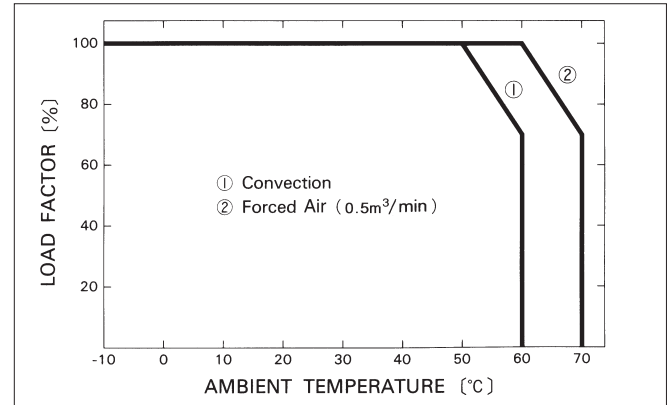

# Mouser Electronics

Authorized Distributor

Click to View Pricing, Inventory, Delivery & Lifecycle Information:

## Cosel:

[LDC60F-1-S](#) [S-LDC30](#) [LDC15F-1-SN](#) [LDC30F-1-S](#) [LDC30F-1-C](#) [LDC15F-2-G](#) [LDC15F-2-SY](#) [LDC15F-1](#)  
[LDC15F-1-Y](#) [LDC30F-1-SY](#) [LDC30F-2-SNC](#) [LDC60F-1-SNCY](#) [LDC30F-2-SNY](#) [LDC60F-2-SN](#) [N-LDC15](#) [LDC15F-1-](#)  
[S](#) [LDC60F-2-G](#) [LDC30F-1-SNG](#) [LDC15F-2-SG](#) [LDC15F-2-SNY](#) [LDC30F-2-SNG](#) [LDC30F-1-SNY](#) [LDC30F-2-C](#)  
[LDC60F-2-SNY](#) [LDC60F-2-CY](#) [LDC60F-1-Y](#) [LDC30F-2-SN](#) [LDC30F-1-SNCY](#) [LDC30F-2-Y](#) [LDC60F-1-Q](#) [LDC60F-1-](#)  
[CY](#) [LDC15F-1-SY](#) [LDC30F-1](#) [LDC15F-1-G](#) [LDC60F-2-S](#) [LDC15F-2-C](#) [LDC60F-1-SNC](#) [LDC30F-1-SNC](#) [LDC15F-2-](#)  
[SNG](#) [N-LDC60](#) [LDC60F-1-GY](#) [LDC60F-2-C](#) [LDC60F-2-SNC](#) [LDC15F-2-S](#) [LDC15F-1-SC](#) [S-LDC60](#) [LDC60F-2](#)  
[LDC60F-1-SNY](#) [LDC60F-2-SNCY](#) [LDC60F-1-C](#) [LDC30F-2](#) [LDC15F-2](#) [LDC30F-2-SNCY](#) [LDC30F-2-G](#) [LDC15F-1-](#)  
[SG](#) [LDC30F-2-S](#) [LDC60F-2-Y](#) [LDC15F-1-SNY](#) [LDC30F-1-GY](#) [LDC15F-2-SC](#) [S-LDC15](#) [LDC60F-1-SY](#) [LDC15F-2-Y](#)  
[LDC15F-1-C](#) [LDC60F-1](#) [LDC15F-2-SN](#) [LDC30F-1-SNGY](#) [LDC60F-2-Q](#) [N-LDC30](#) [LDC30F-1-Y](#) [LDC60F-2-SY](#)  
[LDC60F-1-G](#) [LDC15F-1-SNC](#) [LDC30F-2-SY](#) [LDC30F-1-G](#) [LDC60F-1-SN](#) [LDC30F-1-SN](#)

Компания «Океан Электроники» предлагает заключение долгосрочных отношений при поставках импортных электронных компонентов на взаимовыгодных условиях!

Наши преимущества:

- Поставка оригинальных импортных электронных компонентов напрямую с производств Америки, Европы и Азии, а так же с крупнейших складов мира;
- Широкая линейка поставок активных и пассивных импортных электронных компонентов (более 30 млн. наименований);
- Поставка сложных, дефицитных, либо снятых с производства позиций;
- Оперативные сроки поставки под заказ (от 5 рабочих дней);
- Экспресс доставка в любую точку России;
- Помощь Конструкторского Отдела и консультации квалифицированных инженеров;
- Техническая поддержка проекта, помощь в подборе аналогов, поставка прототипов;
- Поставка электронных компонентов под контролем ВП;
- Система менеджмента качества сертифицирована по Международному стандарту ISO 9001;
- При необходимости вся продукция военного и аэрокосмического назначения проходит испытания и сертификацию в лаборатории (по согласованию с заказчиком);
- Поставка специализированных компонентов военного и аэрокосмического уровня качества (Xilinx, Altera, Analog Devices, Intersil, Interpoint, Microsemi, Actel, Aeroflex, Peregrine, VPT, Syfer, Eurofarad, Texas Instruments, MS Kennedy, Miteq, Cobham, E2V, MA-COM, Hittite, Mini-Circuits, General Dynamics и др.);

Компания «Океан Электроники» является официальным дистрибьютором и эксклюзивным представителем в России одного из крупнейших производителей разъемов военного и аэрокосмического назначения «JONHON», а так же официальным дистрибьютором и эксклюзивным представителем в России производителя высокотехнологичных и надежных решений для передачи СВЧ сигналов «FORSTAR».



## JONHON

«JONHON» (основан в 1970 г.)

Разъемы специального, военного и аэрокосмического назначения:

(Применяются в военной, авиационной, аэрокосмической, морской, железнодорожной, горно- и нефтедобывающей отраслях промышленности)

«FORSTAR» (основан в 1998 г.)

ВЧ соединители, коаксиальные кабели, кабельные сборки и микроволновые компоненты:

(Применяются в телекоммуникациях гражданского и специального назначения, в средствах связи, РЛС, а так же военной, авиационной и аэрокосмической отраслях промышленности).



Телефон: 8 (812) 309-75-97 (многоканальный)

Факс: 8 (812) 320-03-32

Электронная почта: [ocean@oceanchips.ru](mailto:ocean@oceanchips.ru)

Web: <http://oceanchips.ru/>

Адрес: 198099, г. Санкт-Петербург, ул. Калинина, д. 2, корп. 4, лит. А