

# Amphenol Aerospace

## CONTACT US:

Amphenol Aerospace  
40-60 Delaware Avenue  
Sidney, NY 13838-1395

## Customer Service:

Mon - Fri 8AM - 5PM

Phone: (800) 678-0141

Fax: (607) 563-5157

Online: [www.amphenol-aerospace.com](http://www.amphenol-aerospace.com)



*Amphenol Aerospace, Amphenol Commercial Air,  
and Amphenol Industrial Operations Main Facility in Sidney, NY USA*

## ABOUT AMPHENOL AEROSPACE:

Amphenol Aerospace, a Division of Amphenol Corporation, is one of the largest manufacturers of interconnect products in the world for the Military, Commercial Aerospace and Industrial markets. Amphenol designs, manufactures and markets circular and rectangular, electronic, fiber optic, EMI/EMP filter, and a variety of special applications connectors and interconnect systems.

Our state-of-the-art facility is nestled at the foothills of the Catskill Mountains in Sidney, NY. The Amphenol complex houses many technologies including CNC machining, die-casting, molding, impact and extruding, plating, screw machining and process controls. Our fully equipped material evaluation lab and engineering organization utilize the latest in computer aided design software and analysis tools, allowing us to design, test, and qualify advanced interconnect systems. Amphenol's interconnect products are supplied to thousands of OEMs worldwide and are supported by our worldwide sales and engineering force, including the largest global network of electronic distributors.



### Customer-Centric:

Our **#1 priority** is our customers who deserve quality product on time.

### Accountable:

Clear owners, clear actions, clear results.

### Reliable:

What we build matters and quality is imperative.

### Enthusiastic:

Challenges create rewarding opportunities. Enthusiasm is contagious and we will spread it.

## QUALITY ASSURANCE:

Amphenol Aerospace has been awarded both AS9100 - Revision C and ISO9001:2008 Quality Assurance Certifications.

# MIL-DTL-38999, Series I LJT, II JT, III TV, HD

## Insert Availability and Identification Chart

38999

- III
- II
- I
- SJT
- Access
- Aquacon

Series	Series	Series	Military	MIL-DTL-27599 JT/LJT Solder	Crimp	Hermetics			Service Rating	Total Contacts	Contact Size												
						Class H	Class Y	TV*			23 HD	22D	22M	22	20	16	12	12 (Coax)	10 (Power)	8 (Coax)	8†† (Twinax)		
8-2■				P					M	2													
8-3■				X	NA	P	P		M	3													
	9-3■			X					Grounded	1													1
8-6				X	X	P	P		M	6													
	9-6			X	X	P	P		M	7													
	9-7■			X					M	7													
		9-9■							N	9	9												
	9-22■			X					I	2													2
8-35					X	P	P		M	6													
	9-35	9-35	A35		X	P	P	P	M	6													6
8-44					X	P	P		M	4													4
	9-44				X				M	4													
		9-94■			◆				M	2													2
8-97■				X					M	4													2
8-98				S	X	P	P		I	3													3
	9-98	9-98	A98	X	X	P	P	P	I	3													3
	11-2*	11-2*	B2		X	P**			I	2													2
10-4					3				I	4													4
	11-4	11-4		X	2				I	4													4
10-5				X	X	P	P		I	5													5
	11-5	11-5	B5	X	X			P	I	6													6
	11-6■			S					I	6													6
10-13				X	X	P/S	P/S		M	13													13
	11-13			X	X	P/S	P/S		N	19	19												
		11-19■							M	13													13
10-35					X	P/S	P/S		M	13													13
	11-35	11-35	B35		X	P/S	P/S	P	M	13													13
		11-54■			X	◆			II	4													4
10-98				X	X	P/S	P/S		I	6													6
	11-98	11-98	B98	X	X	P/S	P/S	P	I	6													6
10-99					X	P	P		I	7													7
	11-99	11-99	B99		X	X		P	I	7													7
12-3				X	X	◆	P	P	II	3													3
	13-3■				P				II	3													3
12-4				X	X	P	P		I	4													4
	13-4*	13-4*	C4	X	X	P	P	P	I	4													4
12-8				X	X	P	P		I	8													8
	13-8	13-8	C8	X	X	P	P	P	I	8													8
		13-13■							I, Fiber Optic	4													2** 2
12-22					X	P/S	P/S		M	22													22
	13-22			X	X	P/S	P/S		M	22													22
		13-26■			2				M	8													8
		13-32■							N	32	32												6
12-35					X	P/S	P/S		M	22													22
	13-35	13-35	C35		X	P/S	P/S	P	M	22													22
		13-63■			◆				I	4													2 2
12-98				X	X	P/S	P/S		I	10													10
	13-98	13-98	C98	X	X	P/S	P/S	P	I	10													10
		15-AT■			X				I	13													10
14-4■					2				I	4													4
	15-4■	15-4■			2	◆			I	4													4
14-5				X	X	P	P		II	5													5
	15-5*	15-5*	D5	X	X	P	P	P	II	5													5

- X Completely tooled.
- + Majority of tooling is completed (contact Amphenol Aerospace for availability).
- ◆ Not tooled for 02-R.
- P Available with Pin contacts only
- S Available with Socket contacts only
- P/S Available with Pin contacts or Socket contacts
- \* Ground plane proprietary option available. Arrg. 9-5 is exclusively ground plane type.
- Not Mil-Qualified.
- ◇ 21-75 is Mil-Qualified with twinax contacts only.  
Note: MS connector 21-75 is supplied with size 8 twinax.  
Commercial connector 21-75 is supplied with size 8 coax.

- HD designates High Density 38999 Series III insert patterns which use size 23 contacts only. Not rated over 175°C.
- \* Hermetic inserts - solder termination standard. (Contact Amphenol Aerospace for optional PCB or eyelet termination).
- \*\* Two size 16 contacts dedicated to fiber optics. See the Fiber Optic section for more information.
- \*\*\* For use in MIL-STD-1760 applications (see pages 75 and 76).  
For RG 180/U and RG 195/U cables only.
- † Size 8 Coax and Twinax are interchangeable.
- †† Size 8 Coax and Twinax are interchangeable.
- (2) Not Tooled for RP or 02RE
- (3) Pin inserts only, not tooled for RP or 02RE (Consult Amphenol Aerospace for avail.)
- (5) MS Connector 21-79 has provision for two size 8 coax contacts. Coax contacts are not supplied unless specified by customer.

# MIL-DTL-38999, Series I LJT, II JT, III TV, HD

## Insert Availability and Identification Chart

Series	Series	Series	Military	MIL-DTL-27599		Hermetics						Contact Size									
JT II	LJT I	TV III	III	JT/LJT Solder	Crimp	Class H	Class Y	TV*	Service Rating	Total Contacts	23 HD	22D	22M	22	20	16	12	12 (Coax)	8 (Coax)	8†† (Twinax)	4
14-15				X	X	P	P		I	15					14	1					
	15-15	15-15	D15	X	X	P/S	P/S	P	I												
14-18				X	X	P/S	P/S		I	18					18						
	15-18	15-18	D18	X	X	P/S	P/S	P	I												
14-19				X	X				I	19					19						
	15-19	15-19	D19		X	P	P	P	I												
14-35					X	P	P		M	37		37									
	15-35	15-35	D35		X	P/S	P/S	P	M												
14-37				X	X	P	P		M	37			37								
	15-37			X	X	P	P		M												
		15-55							N	55	55										
14-68					2	P	P		1	8						8					
	15-68			X	X																
14-97					X	P	P		I	12					8	4					
	15-97	15-97	D97	X	X	P	P	P	I												
	17-2	17-2	E2		X	♦			M	39		38								1	
		17-EA							M	19		10			3	2	4				
		17-EC							M	41		32			9						
16-6					X	P	P		I	6										6	
	17-6	17-6	E6		X	P	P	P	I												
16-8				X	X	P	P		II	8						8					
	17-8*	17-8*	E8	X	X	P/S	P/S	P	II												
16-13					2				I	13						13					
	17-13				2				I												
	17-22	17-22			♦				Coax	4							2	2			
	17-25	17-25			2				M	24		22						2			
16-26				X	X	P/S	P/S		I	26					26						
	17-26	17-26	E26	X	X	P/S	P/S	P	I												
16-35					X	P	P		M	55		55									
	17-35	17-35	E35	X	X	P	P	P	M												
16-42					X				M	42				42							
	17-42				P				M												
		17-52			X	♦			M	2										2	
16-55				X	X	P/S	P/S		M	55			55								
	17-55			X	X	P/S	P/S		M												
		17-60			X				I/Coax	10		8						2			
		17-73							N	73	73										
16-99				X	X	P	P		I	23					21	2					
	17-99	17-99	E99	X	X	P	P		I												
		19-AD			X	♦			Inst.	17					16					1	
		19-FA							M	23		6			8	7	2				
18-11				X	X	P	P		II	11						11					
	19-11*	19-11*	F11	X	X	P	P	P	II												
	19-18	19-18	F18		2	2			M	18		14								4	
18-28				X	X				I	28					26	2					
	19-28	19-28	F28	X	P	X			I												
18-30				X	X				I	30					29	1					
	19-30			X	P				I												
		19-31			X				M	15		12					1		2		
18-32				X	X	P/S	P/S		I	32					32						
	19-32	19-32	F32	X	X	P/S	P/S	P	I												
18-35					X	P	P		M	66		66									
	19-35	19-35	F35		X	P	P	P	M												
18-53				X	X				M	53				53							
	19-53				P				M												
18-66				X	X	P	P		M	66			66								
	19-66				X	P	P		M												
	19-67			X	3	S	S		M	67		67									
18-68					2				I	18					18						
	19-68	19-68			3	S			I												
18-96					2				I	9						9					
		19-88							N	88	88										
20-1					X	P	P		M	79											
	21-1				X	P/S	P/S		M												

38999

- III
- II
- I
- SJT
- Access
- Aquacon

# MIL-DTL-38999, Series I LJT, II JT, III TV, HD

## Insert Availability and Identification Chart

38999

Series	Series	Series	Military	MIL-DTL-27599 JT/LJT Solder	Crimp	Hermetics			Service Rating	Total	Contact Size													
						H	Y	TV*			23 HD	22D	22M	22	20	16	16 (Cx)	12 (Cx)	10 (Power)	8 (Power)	8 (Cx)	8†† (Twinax)	4	
20-2					X				M	65														
	21-2■				X																			
20-11■					3				I	11														
	21-11★	21-11★	G11		X																			
20-16				X	X	P/S	P/S		II	16														
	21-16★	21-16★	G16	X	X	P	P	P																
	21-25■								I	25														
	21-27■			X					I	27														
		21-29			X				I	27														
20-35					X	P	P		M	79														
	21-35	21-35	G35		X	P/S	P/S	P																
20-39				X	X	P	P	P	I	39														
	21-39	21-39	G39	X	X	P	P	P																
20-41				X	X	P	P	P	I	41														
	21-41	21-41	G41	X	X	P/S	P/S	P																
		21-48■							M	4														
	21-75★	21-75★◇	G75		2 X				N   M	4														
	21-79■	21-79■			2 X				II	19														
		21-121■							N	121	121													
22-1					X	P/S	P/S		M	100														
	23-1				X	P	P																	
22-2				X	X	P	P		M	85														
	23-2			X	X	P	P																	
	23-6★■	23-6★■		X	P				M	6														
22-14■					2	◆			I	14														
	23-14■	23-14■			2	◆																		
22-21				X	X	P	P		II	21														
	23-21★	23-21★	H21	X	X	P	P	P																
22-32				X	X	P	P		I	32														
	23-32■			X	P																			
	23-34■			X					I	34														
22-35					X	P/S	P/S		M	100														
	23-35	23-35	H35		X	P	P	P																
22-53■					P				I	53														
	23-53	23-53	H53	X	X	P/S	P/S	P																
		23-54■			X				M	53														
22-55				X	X	P	P		I	55														
	23-55	23-55	H55		X			P																
		23-63■			S				M	57														
	23-97■			X					II	16														
	23-99■			X					II	11														
		23-151■							N	151	151													
24-1					X	P	P		M	128														
	25-1				X	P	P																	
24-2					X				M	100														
	25-2				X																			
24-4					X	P	P		I	56														
	25-4	25-4	J4		X			P																
	25-7■	25-7	J7		X				M   Twx	99														
		25-8★	J8		◆				Twinax	8														
		25-11***	J11		2	◆			N	11														
		25-16■							M	8														
		25-17■			◆				M	42														
24-19■					X	P	P		I	19														
	25-19★	25-19★	J19		X			P																
	25-20■	25-20***	J20		2	◆			N	30														

- X Completely tooled.
- + Majority of tooling is completed (contact Amphenol Aerospace for availability).
- ◆ Not tooled for 02-R.
- P Available with Pin contacts only
- S Available with Socket contacts only
- P/S Available with Pin contacts or Socket contacts
- ★ Ground plane proprietary option available. Arrg. 9-5, 26-62 is exclusively ground plane type.
- Not Mil-Qualified.
- ◇ 21-75 is Mil-Qualified with twinax contacts only.
- \* Hermetic inserts - solder termination standard. (Contact Amphenol Aerospace for optional PCB or eyelet termination).
- HD designates High Density 38999 Series III insert patterns which use size 23 contacts only. Not rated over 175°C.
- \*\* Two size 16 contacts dedicated to fiber optics. See the Fiber Optic Section for more information.
- \*\*\* For use in MIL-STD-1760 applications (see pages 75 and 76).
- † For RG 180/U and RG 195/U cables only.
- †† Size 8 Coax and Twinax are interchangeable.
- (2) Not Tooled for RP or 02RE
- (3) Pin inserts only, not tooled for RP or 02RE (Consult Amphenol for avail.)
- (4) MS connector 21-75 is supplied with size 8 twinax. Commercial connector 21-75 is supplied with size 8 coax.
- (5) MS Connector 21-79 has provision for two size 8 coax contacts. Coax contacts are not supplied unless specified by customer.
- (PWR) Suffix at end of part number to replace coax, twinax, and fiber contacts with power contacts.

## Insert Availability and Identification Chart

Series	Series	Series	Military	MIL-DTL-27599	JT/LJT Solder	Hermetics				Service Rating	Total Contacts	Contact Size											
						Crimp	H	Y	TV*			23 HD	22D	20	16	12 (Fiber)	12 (Coax)	10	8 (Coax)	8†† (Twinax)	8 (Quadrx)	4	
24-24						X	P	P		I	24				12		12						
	25-24★	25-24★	J24			X	P	P		I	25			16			5			4			
		25-26■*				+				I	25												
24-29						X				I	29				29								
	25-29★	25-29★	J29		X	X				I	29												
24-35						X	P	P		New													
	25-35	25-35	J35			X	P	P	P	M	128		128										
24-37						X				I	37				37								
	25-37★	25-37★	J37			X				I	37												
		25-41■								N	Inst.	41		22	3	11		2			3		
24-43■						3				I	43				23	20							
	25-43	25-43	J43		X	2	◆			I	43												
	25-46	25-46	J46			2	◆			I	46				40	4				2			
24-61						X	X	P	P	I	61				61								
	25-61	25-61	J61		X	X	P	P	P	I	61												
		25-62■*				X	◆			I	12				8								4
		25-90	J90			◆				I	46				40	4					2		
		25-187■								N	187		187										
		25-1A■								N	8				4								4
		25-AT■				X				M	60			31	12	11	2		2			2	
		25-F4■				X				M/I	66			49		13							

38999

- III
- II
- I
- SJT
- Access
- Aquacon

### TV SERIES III

#### SELECT SHELL SIZE - SPECIAL INSERT ARRANGEMENT

(Not Mil-Spec Qualified)

Shell Size-Insert Arrg.	Crimp	Hermetics*	Service Rating	Total Contacts	Comments	Contact Size			
						22D	20	16	12
9-2	X		I	2	Formerly Pyle		2		
15-4	X		II	4	Formerly Pyle			4	
15-25	X		M	25	Formerly Pyle	22		3	
17-20	X		M	20	Formerly Pyle	16			4
21-12	X		I	12	Formerly Pyle		3		9
21-21	X		M/Inst.	41	Improved sealing	32			9
21-99	X		M	16	Formerly Pyle	5			11
25-92	X		M	101	Formerly Pyle	92		9	
25-97	X		M	42	Formerly Pyle	26		3	13

### LJT SERIES I

#### SELECT SHELL SIZE - SPECIAL INSERT ARRANGEMENT

(Not Mil-Spec Qualified)

Shell Size-Insert Arrg.	Crimp	Service Rating	Total Contacts	Comments	Contact Size			
					22D	20	16	12
25-64	X		64	Formerly Pyle	40	8	10	6

- X Completely tooled.
- + Majority of tooling is completed (contact Amphenol Aerospace for availability).
- ◆ Not tooled for 02-R.
- P Pin inserts only (contact Amphenol Aerospace for socket availability).
- ★ Ground plane proprietary option available. Arrangement 9-5, 25-62 is exclusively ground plane type.
- Not Mil-Qualified.
- \* Hermetic inserts - solder termination standard. (Contact Amphenol Aerospace for optional PCB or eyelet termination).
- \*\* Two size 16 contacts dedicated to fiber optics. See the Fiber Optic section for more information.
- \*\*\* For use in MIL-STD-1760 applications (pgs. 75 and 76).
- † For RG 180/U and RG 195/U cables only.
- †† Size 8 Coax and Twinax are interchangeable.
- Note: 25L-3 and 25L-7 use longer shells.
- (PWR) Suffix at end of part number to replace coax, twinax, and fiber contacts with power contacts.

### SELECT NON-STANDARD SHELL SIZE

- Special Insert Arrangement

Shell Size-Insert Arrg.	Crimp	Hermetics*	Service Rating	Total Contacts	Contact Size				
					22D	20	8	4	0
25L-3	X		II	3			1	2	
25L-7	X		II	7			7		
33-3	X		II	3				1	2
33-5	X		II	5				5	
33-6	X		II	6			2	4	
37-5	X		II	4					4

(Insert arrangements requiring non-standard shells)

# MIL-DTL-38999, Series I LJT, II JT, III TV, HD

## Insert Arrangements

Front face of pin inserts illustrated

38999

- III
- II
- I
- SJT
- Access
- Aquacon

Shell Size & Insert Arrg. for:



<b>Series II JT</b>	8-2	8-3		8-6				8-35	8-44		8-97	8-98	
<b>Series I LJT</b>		9-3		9-6	9-7		9-22	9-35	9-44			9-98	11-2
<b>Series III TV</b>			9-5			9-9 HD		9-35		9-94		9-98	11-2
Service Rating	M	M	Grounded	M	M	N	I	M	M	M	M	I	I
Number of Contacts	2	3	1	6	7	9	2	6	4	2	2	3	2
Contact Size	20	20	8 Twinax	22M	22M	23	20	22D	22	20	22M 20	20	16

Shell Size & Insert Arrg. for:



<b>Series II JT</b>	10-4	10-5		10-13			10-35		10-98	10-99	12-3	12-4
<b>Series I LJT</b>	11-4	11-5	11-6	11-13			11-35		11-98	11-99	13-3	13-4
<b>Series III TV</b>	11-4	11-5			11-19 HD		11-35	11-54	11-98	11-99		13-4
Service Rating	I	I	I	M	N		M	II	I	I	II	I
Number of Contacts	4	5	6	13	19		13	4	6	7	3	4
Contact Size	20	20	20	22M	23		22D	22D	20	20	16	16

Shell Size & Insert Arrg. for:



<b>Series II JT</b>	12-8	12-22			12-35			12-98		14-4	14-5
<b>Series I LJT</b>	13-8	13-22			13-35			13-98		15-4	15-5
<b>Series III TV</b>	13-8		13-26	13-32 HD	13-35	13-63	13-98		15-AT	15-4	15-5
Service Rating	I	M	M	N	M	I	I	I	I	I	II
Number of Contacts	8	22	6 2	32	22	2 2	10	10 3	4	5	
Contact Size	20	22M	22D 12	23	22D	16 12	20	22D 12	12	16	

Shell Size & Insert Arrg. for:



<b>Series II JT</b>	14-15	14-18	14-19		14-35	14-37		14-68	14-97
<b>Series I LJT</b>	15-15	15-18	15-19		15-35	15-37		15-68	15-97
<b>Series III TV</b>	15-15	15-18	15-19	15-25	15-35		15-55 HD		15-97
Service Rating	I	I	I	M	M	M	N	I	I
Number of Contacts	14 1	18	19	22 3	37	37	55	8	8 4
Contact Size	20 16	20	20	22D 16	22D	22M	23	16	20 16

Shell Size & Insert Arrg. for:



<b>Series II JT</b>					16-6	16-8	16-13	
<b>Series I LJT</b>				17-2	17-6	17-8	17-13	17-22
<b>Series III TV</b>	17-EA	17-EC		17-2	17-6	17-8		17-22
Service Rating				M	I	II	I	Coax
Number of Contacts	10 3 2 4	32 9	38 1	6	8	13	2 2	
Contact Size	22D 20 16 12	22D 20	22D 8 Twinax	12	16	16	12 Coax 8 Coax	



HD: High Density HD38999 (use size 23 contacts only)

CONTACT LEGEND

# MIL-DTL-38999, Series I LJT, II JT, III TV, HD

## Insert Arrangements

Front face of pin inserts illustrated

38999

III
II
I
SJT
Access
Aquacon

Shell Size & Insert Arr. for:						
<b>Series II JT</b>		16-26	16-35	16-42	16-55	
<b>Series I LJT</b>	17-25	17-26	17-35	17-42	17-55	
<b>Series III TV</b>		17-26	17-35		17-52	17-60
Service Rating	M	I	M	M	M	I/Coax
Number of Contacts	22 2	26	55	42	55	8 2
Contact Size	22D 8 Coax	20	22D	22	8 Twinax 22M	22D 8 Coax

Shell Size & Insert Arr. for:						
<b>Series II JT</b>		16-99		18-11		18-28
<b>Series I LJT</b>		17-99		19-11	19-18	19-28
<b>Series III TV</b>	17-73 HD	17-99	19-FA	19-11	19-18	19-28
Service Rating	N	I	M	II	M	M
Number of Contacts	73	21 2	6 8 7 2	11	14 4	26 2
Contact Size	23	20 16	22D 20 16 12	16	22D 8 Twinax	20 16

Shell Size & Insert Arr. for:						
<b>Series II JT</b>	18-30		18-32	18-35	18-53	18-66
<b>Series I LJT</b>	19-30		19-32	19-35	19-53	19-66
<b>Series III TV</b>		19-31	19-32	19-35		
Service Rating	I	M	I	M	M	M
Number of Contacts	29 1	2 1 12	32	66	53	66
Contact Size	20 16	8 Coax 12 22D	20	22D	22	22M

Shell Size & Insert Arr. for:						
<b>Series II JT</b>		18-68		18-96		
<b>Series I LJT</b>	19-67	19-68				
<b>Series III TV</b>			19-88 HD		19-AD	19-FA
Service Rating	M	I	N	I	Inst.	M
Number of Contacts	67	18	88	9	16 1	6 8 7 2
Contact Size	22M	16	23	12	20 8 Twinax	22D 20 16 12

CONTACT LEGEND

--	--	--	--	--	--	--	--	--

HD: High Density HD38999  
(use size 23 contacts only)

# MIL-DTL-38999, Series I LJT, II JT, III TV, HD

## Insert Arrangements

Front face of pin inserts illustrated

38999

III

II

I

SJT

Access

Aquacon

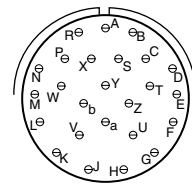
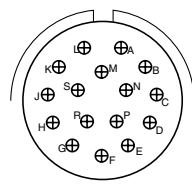
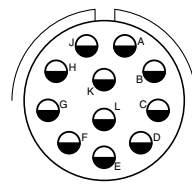
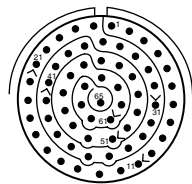
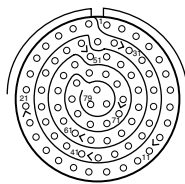

Shell Size & Insert Arrg. for:

Series II JT	20-1	20-2	20-11	20-16	
Series I LJT	21-1	21-2	21-11	21-16	21-25
Series III TV			21-11	21-16	
Service Rating	M	II	I	II	I
Number of Contacts	79	65	11	16	25
Contact Size	22M	22	12	16	20

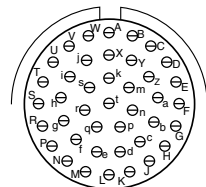
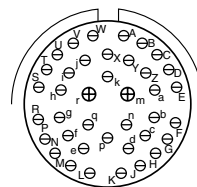
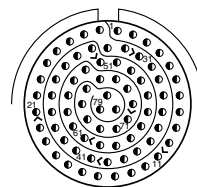
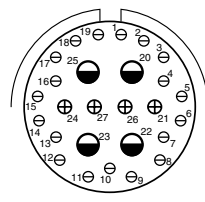
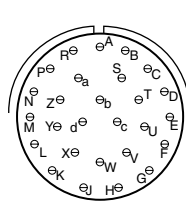

Shell Size & Insert Arrg. for:

Series II JT			20-35	20-39	20-41
Series I LJT	21-27		21-35	21-39	21-41
Series III TV		21-29	21-35	21-39	21-41
Service Rating	I	I	M	1	I
Number of Contacts	27	19 4 4	79	37 2	41
Contact Size	20	20 16 12	22D	20 16	20

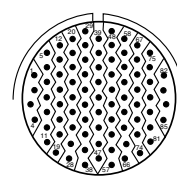
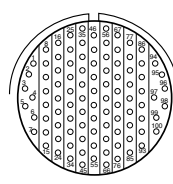
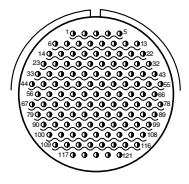
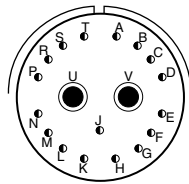
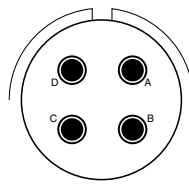
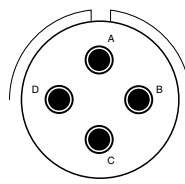

Shell Size & Insert Arrg. for:

Series II JT				22-1	22-2
Series I LJT		21-75	21-79	23-1	23-2
Series III TV	21-48	21-75	21-79	21-121 HD	
Service Rating	M	N	II	N	M
Number of Contacts	4	4	17 (See Note)	121	100
Contact Size	8 power	(See Note)	22D	23	22M

**HD:** High Density HD38999 (use size 23 contacts only)

**Note:** MS connector 21-75 is supplied with four size 8 twinax contacts.

Commercial connector 21-75 is supplied with four size 8 coax contacts.

MS connector 21-79 has provision for two size 8 coax contacts.

Coax contacts are not supplied unless specified by customers.

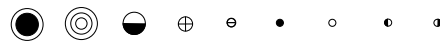

CONTACT LEGEND 8 10 12 16 20 22 22M 22D 23



# MIL-DTL-38999, Series I LJT, II JT, III TV, HD

## Insert Arrangements

Front face of pin inserts illustrated

38999

III
II
I
SJT
Access
Aquacon



Shell Size &  
Insert Arrg. for:

<b>Series II JT</b>	22-14	22-21	22-32	
<b>Series I LJT</b>	23-14	23-21	23-32	23-34
<b>Series III TV</b>	23-6	23-21		
Service Rating	<b>I</b>	<b>II</b>	<b>I</b>	<b>I</b>
Number of Contacts	<b>14</b>	<b>21</b>	<b>32</b>	<b>34</b>
Contact Size	<b>12</b>	<b>16</b>	<b>20</b>	<b>20</b>



Shell Size &  
Insert Arrg. for:

<b>Series II JT</b>	22-35	22-53	22-55	
<b>Series I LJT</b>	23-35	23-53	23-55	23-63
<b>Series III TV</b>	23-35	23-53	23-55	23-63
Service Rating	<b>M</b>	<b>I</b>	<b>I</b>	<b>M</b>
Number of Contacts	<b>22D</b>	<b>20</b>	<b>20</b>	<b>49</b> <b>4</b> <b>4</b>
Contact Size				<b>Coax</b> <b>Coax</b>

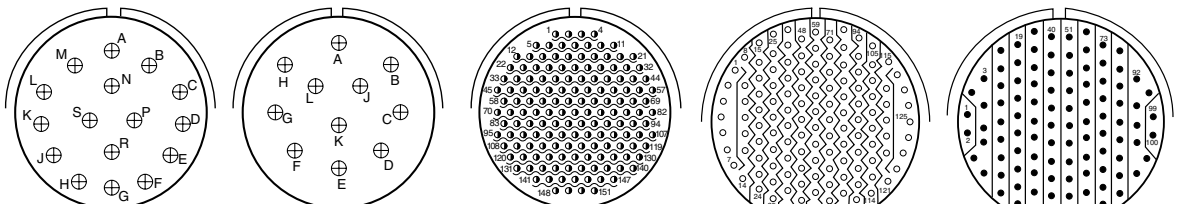

Shell Size &  
Insert Arrg. for:

<b>Series II JT</b>	23-97	23-99	24-1	24-2
<b>Series I LJT</b>	23-97	23-99	25-1	25-2
<b>Series III TV</b>	23-97	23-99	23-151 HD	25-2
Service Rating	<b>II</b>	<b>II</b>	<b>M</b>	<b>M</b>
Number of Contacts	<b>16</b>	<b>11</b>	<b>128</b>	<b>100</b>
Contact Size	<b>16</b>	<b>16</b>	<b>22M</b>	<b>22</b>

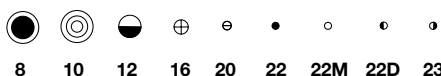

CONTACT LEGEND

**HD:** High Density HD38999  
(use size 23 contacts only)

# MIL-DTL-38999, Series I LJT, II JT, III TV

## Insert Arrangements

Front face of pin inserts illustrated

38999

III

II

I

SJT

Access

Aquacon



Shell Size & Insert Arrg. for:

Series II JT	24-4		25-7		25-8		25-11	
Series I LJT	25-4		25-7		25-8		25-11***	
Series III TV	25-4		25-7		25-8		25-11***	
Service Rating	I		M		Twinax		N	
Number of Contacts	48	8	97	2	8	2	9	
Contact Size	20	16	22D	8 Twinax	8 Twinax	20	10	



Shell Size & Insert Arrg. for:

Series II JT	25-16		25-17		24-19		25-20	
Series I LJT	25-16		25-17		25-19		25-20***	
Series III TV	25-16		25-17		25-19		25-20***	
Service Rating	M		M		I		N	
Number of Contacts	6	2	36	6	19	10	13	3
Contact Size	20	4	22D	8 Twinax	12	20	16	8 Twinax
								12 Coax
								(With Matched Impedance)



Shell Size & Insert Arrg. for:

Series II JT	24-24		24-29		24-35	
Series I LJT	25-24		25-29		25-35	
Series III TV	25-24		25-29		25-35	
Service Rating	I		I		M	
Number of Contacts	12	12	16	5	4	128
Contact Size	16	12	20	12	8 Coax	22D

\*\*\* For use in MIL-STD-1760 applications (see pages 75 and 76).



CONTACT LEGEND 8 10 12 16 20 22 22M 22D 23

# MIL-DTL-38999, Series I LJT, II JT, III TV, HD

## Insert Arrangements

Front face of pin inserts illustrated

38999

III
II
I
SJT
Access
Aquacon

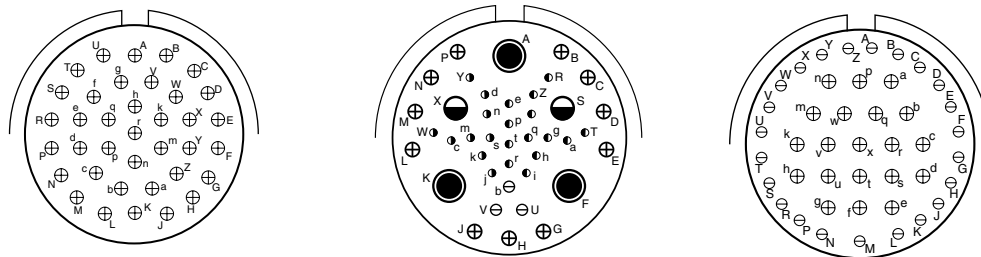

Shell Size &  
Insert Arr. for:

Series II JT

Series I LJT

Series III TV

Service Rating

Number of Contacts

Contact Size

	24-37					25-43		
	25-37					25-43		
	25-37		25-41			25-43		
	I		N/Inst.			I		
	37	22	3	11	2	3	23	20
	16	22D	20	16	12 Coax	8 Twinax	20	16

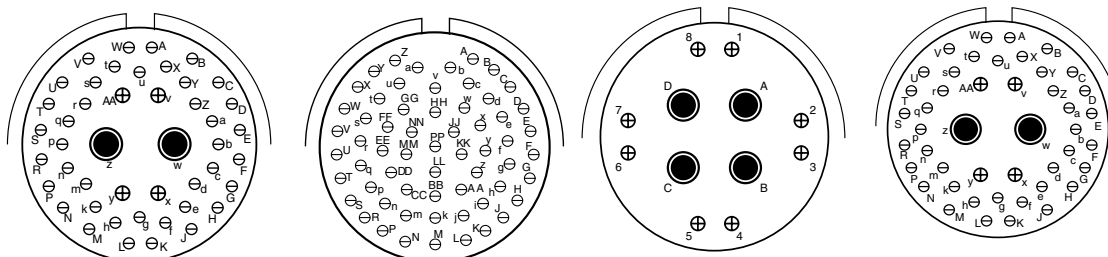

Shell Size &  
Insert Arr. for:

Series II JT

Series I LJT

Series III TV

Service Rating

Number of Contacts

Contact Size

	25-46		24-61						
	25-46		25-61						
	25-46		25-61		25-62	25-90			
	I		I		I	I			
	40	4	2	61	8	4	40	4	2
	20	16	8 Coax †	20	16	8	20	16	8 Twinax
					Ground Plane Only				

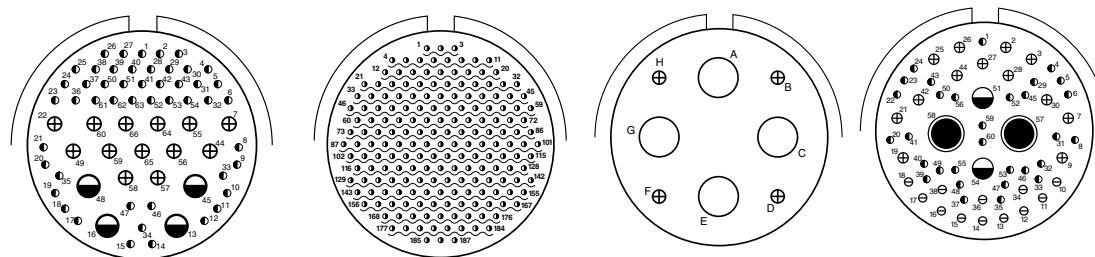

Shell Size &  
Insert Arr. for:

Series II JT

Series I LJT

Series III TV

Service Rating

Number of Contacts

Contact Size

	25-F4		25-187 HD		25-1A		25-AT				
	Size 22D=M, Balance =I		N		N		N				
	49	13	4	187	4	4	2	2	13	12	31
	22D	16	12	23	16	4	10	12	16	20	22D

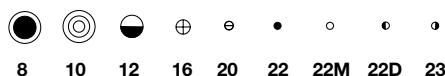

† Coax contacts for RG180/U or RG195/U cable.

HD: High Density HD38999  
(use size 23 contacts only)

CONTACT LEGEND

# MIL-DTL-38999, Series III TV

## Special Insert Arrangements

38999

III

II

I

SJT

Access

Aquacon

Series III

Front face of pin inserts illustrated

Shell Size &  
Insert Arrg. for:



Series III TV	9-2	15-4*	15-25	
Service Rating	I	II	M	
Number of Contacts	2	4	22	3
Contact Size	20	16	22D	16

Shell Size &  
Insert Arrg. for:

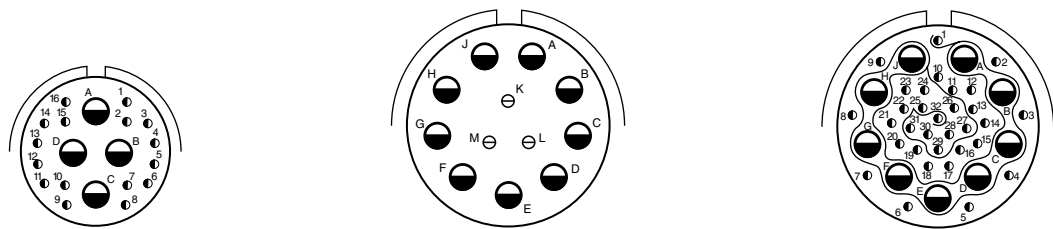

Series III TV	17-20		21-12		21-21	
Service Rating	M		I		M/Inst.	
Number of Contacts	16	4	3	9	32	9
Contact Size	22D	12	20	12	22D	12

Shell Size &  
Insert Arrg. for:

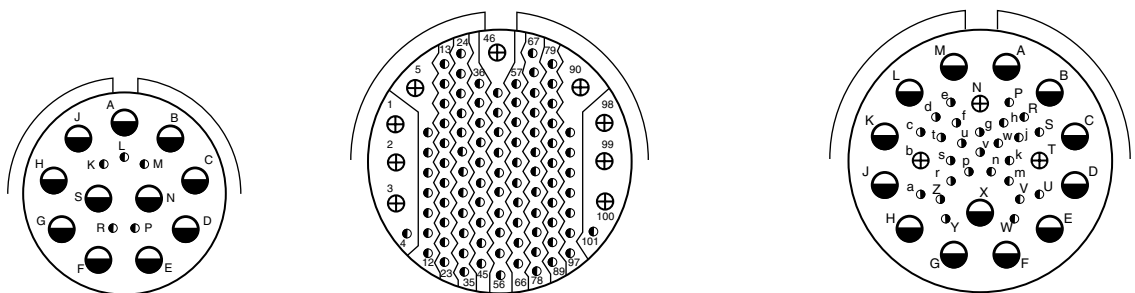

Series III TV	21-99		25-92		25-97		
Service Rating	M		M		M		
Number of Contacts	5	11	92	9	26	3	13
Contact Size	22D	12	22D	16	22D	16	12

NOTE: Some specials shown here were formerly known as Pyle arrangements.  
Consult Amphenol for how to order information for connectors with these inserts.  
For further information on special arrangements consult Amphenol Aerospace, Sidney NY.  
\* Pyle 15-4 does not mate with Amphenol Tri-Start 15-4 insert.

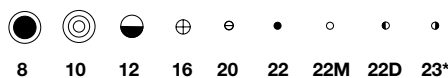

# MIL-DTL-38999, Series III TV

## Special Insert Arrangements

### Non-Standard Shells or Large Contacts

Front face of pin inserts illustrated



Shell Size &  
Insert Arrg. for:

Series III TV	25L-3		25L-7
Service Rating	II		II
Number of Contacts	1	2	7
Contact Size	8	4	8



Shell Size &  
Insert Arrg. for:

Series III TV	33-3		33-5	33-6	
Service Rating	II		II	II	
Number of Contacts	1	2	5	2	4
Contact Size	4	0	4	8	4



Shell Size &  
Insert Arrg. for:

Series III TV	37-5
Service Rating	II
Number of Contacts	4
Contact Size	0

NOTE: Some specials shown here were formerly known as Pyle arrangements. Consult Amphenol for how to order information for connectors with these inserts.

Consult Amphenol Aerospace for longer shell drawings.

#### CONTACT LEGEND

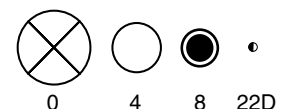

38999

III

II

I

SJT

Access

Aquacon

Series III

A

# PCB Contacts 38999, Series I LJT, II JT, III TV

## Insert Arrangements

38999

### INSERT ARRANGEMENT #8-3 / 9-3

Connector Type:	JT MIL-DTL-38999 Series II	LJT MIL-DTL-38999 Series I	Tri-Start MIL-DTL-38999 Series III	Number of Contacts	Contact Size	Service Rating
Insert Designation:	8-3	9-3	NA	3	20	M

#### Contact Locations

Front face of pin insert shown



\*Service Rating: M for MIL-DTL-38999

### INSERT ARRANGEMENT #8-35 / 9-35

Connector Type:	JT MIL-DTL-38999 Series II	LJT MIL-DTL-38999 Series I	Tri-Start MIL-DTL-38999 Series III	Number of Contacts	Contact Size	Service Rating
Insert Designation:	8-35	9-35	9-35	6	22D	M

#### Contact Locations

Front face of pin insert shown



All dimensions for reference only. For alternate rotations see page 46 for Series III, page 86 for Series II, and page 114 for Series I.  
Note: Shown in this catalog are the most common insert patterns for PCB applications. For availability of other arrangements, consult Amphenol Aerospace.

# PCB Contacts 38999, Series I LJT, II JT, III TV

## Insert Arrangements

### INSERT ARRANGEMENT #8-98 / 9-98

Connector Type:	JT MIL-DTL-38999 Series II	LJT MIL-DTL-38999 Series I	Tri-Start MIL-DTL-38999 Series III	Number of Contacts	Contact Size	Service Rating
Insert Designation:	8-98	9-98	9-98	3	20	I

#### Contact Locations

Front face of pin insert shown



### INSERT ARRANGEMENT #10-5 / 11-5

Connector Type:	JT MIL-DTL-38999 Series II	LJT MIL-DTL-38999 Series I	Tri-Start MIL-DTL-38999 Series III	Number of Contacts	Contact Size	Service Rating
Insert Designation:	10-5	11-5	11-5	5	20	I

#### Contact Locations

Front face of pin insert shown



All dimensions for reference only. For alternate rotations see page 46 Series III, page 86 Series II, and page 114 Series I.

Note: Shown in this catalog are the most common insert patterns for PCB applications. For availability of other arrangements, consult Amphenol Aerospace.

38999

III

II

I

SJT

Access

Aquacon

Series III, II, I

# PCB Contacts 38999, Series I LJT, II JT, III TV

## Insert Arrangements

38999

### INSERT ARRANGEMENT #10-6 / 11-6

Connector Type:	JT MIL-DTL-38999 Series II	LJT MIL-DTL-38999 Series I	Tri-Start MIL-DTL-38999 Series III	Number of Contacts	Contact Size	Service Rating
Insert Designation:	NA	11-6	NA	6	20	I

#### Contact Locations

Front face of pin insert shown



### INSERT ARRANGEMENT #10-35 / 11-35

Connector Type:	JT MIL-DTL-38999 Series II	LJT MIL-DTL-38999 Series I	Tri-Start MIL-DTL-38999 Series III	Number of Contacts	Contact Size	Service Rating
Insert Designation:	10-35	11-35	11-35	13	22D	M

#### Contact Locations

Front face of pin insert shown



All dimensions for reference only. For alternate rotations see page 46 for Series III, page 86 for Series II, and page 114 for Series I.  
Note: Shown in this catalog are the most common insert patterns for PCB applications. For availability of other arrangements, consult Amphenol Aerospace.



# PCB Contacts 38999, Series I LJT, II JT, III TV

## Insert Arrangements

### INSERT ARRANGEMENT #12-3 / 13-3

Connector Type:	JT MIL-DTL-38999 Series II	LJT MIL-DTL-38999 Series I	Tri-Start MIL-DTL-38999 Series III	Number of Contacts	Contact Size	Service Rating
Insert Designation:	12-3	13-3	NA	3	16	II

#### Contact Locations

Front face of pin insert shown



### INSERT ARRANGEMENT #12-35 / 13-35

Connector Type:	JT MIL-DTL-38999 Series II	LJT MIL-DTL-38999 Series I	Tri-Start MIL-DTL-38999 Series III	Number of Contacts	Contact Size	Service Rating
Insert Designation:	12-35	13-35	13-35	22	22D	M

#### Contact Locations

Front face of pin insert shown



All dimensions for reference only. For alternate rotations see page 46 for Series III, page 86 for Series II, and page 114 for Series I.  
Note: Shown in this catalog are the most common insert patterns for PCB applications. For availability of other arrangements, consult Amphenol Aerospace.

# PCB Contacts 38999, Series I LJT, II JT, III TV

## Insert Arrangements

### INSERT ARRANGEMENT #14-18 / 15-18

Connector Type:	JT MIL-DTL-38999 Series II	LJT MIL-DTL-38999 Series I	Tri-Start MIL-DTL-38999 Series III	Number of Contacts	Contact Size	Service Rating
Insert Designation:	14-18	15-18	15-18	18	20	I

#### Contact Locations

Front face of pin insert shown



### INSERT ARRANGEMENT #14-19 / 15-19

Connector Type:	JT MIL-DTL-38999 Series II	LJT MIL-DTL-38999 Series I	Tri-Start MIL-DTL-38999 Series III	Number of Contacts	Contact Size	Service Rating
Insert Designation:	14-19	15-19	15-19	19	20	I

#### Contact Locations

Front face of pin insert shown



All dimensions for reference only. For alternate rotations see page 46 for Series III, page 86 for Series II, and page 114 for Series I.  
 Note: Shown in this catalog are the most common insert patterns for PCB applications. For availability of other arrangements, consult Amphenol Aerospace.

# PCB Contacts 38999, Series I LJT, II JT, III TV

## Insert Arrangements

### INSERT ARRANGEMENT #14-35 / 15-35

<b>Connector Type:</b>	JT MIL-DTL-38999 Series II	LJT MIL-DTL-38999 Series I	Tri-Start MIL-DTL-38999 Series III	Number of Contacts	Contact Size	Service Rating
Insert Designation:	14-35	15-35	15-35	37	22D	M

#### Contact Locations

Front face of pin insert shown



Contact Hole Locations			Contact Hole Locations		
Contact Number	Location		Contact Number	Location	
	X Axis	Y Axis		X Axis	Y Axis
1	+045	+262	19	+045	+172
2	+123	+217	20	+123	+119
3	+211	+160	21	+170	+040
4	+254	+080	22	+170	-050
5	+266	-010	23	+123	-127
6	+247	-098	24	+045	-172
7	+200	-175	25	-045	-172
8	+130	-232	26	-123	-127
9	+045	-262	27	-170	-050
10	-045	-262	28	-170	+040
11	-130	-232	29	-123	+119
12	-200	-175	30	-045	+172
13	-247	-098	31	+045	+074
14	-266	-010	32	+090	-004
15	-254	+080	33	+045	-082
16	-211	+160	34	-045	-082
17	-123	+217	35	-090	-004
18	-045	+262	36	-045	+074
			37	.000	-004

### INSERT ARRANGEMENT #16-26 / 17-26

<b>Connector Type:</b>	JT MIL-DTL-38999 Series II	LJT MIL-DTL-38999 Series I	Tri-Start MIL-DTL-38999 Series III	Number of Contacts	Contact Size	Service Rating
Insert Designation:	NA	17-26	17-26	26	20	I

#### Contact Locations

Front face of pin insert shown



Contact Hole Locations			Contact Hole Locations		
Contact Number	Location		Contact Number	Location	
	X Axis	Y Axis		X Axis	Y Axis
A	.000	+321	R	-131	+293
B	+131	+293	S	-070	+177
C	+239	+214	T	+070	+177
D	+305	+099	U	+175	+094
E	+319	-034	V	+178	-036
F	+278	-161	W	+119	-151
G	+189	-260	X	.000	-203
H	+067	-314	Y	-119	-151
J	-067	-314	Z	-178	-036
K	-189	-260	a	-175	+094
L	-278	-161	b	.000	+065
M	-319	-034	c	.000	-065
N	-305	+099			
P	-239	+214			

All dimensions for reference only. For alternate rotations see page 46 for Series III, page 86 for Series II, and page 114 for Series I.

Note: Shown in this catalog are the most common insert patterns for PCB applications.

For availability of other arrangements, consult Amphenol Aerospace.

# PCB Contacts 38999, Series I LJT, II JT, III TV

## Insert Arrangements

38999

### INSERT ARRANGEMENT #16-35 / 17-35

<b>Connector Type:</b>	JT MIL-DTL-38999 Series II	LJT MIL-DTL-38999 Series I	Tri-Start MIL-DTL-38999 Series III	<b>Number of Contacts</b>	<b>Contact Size</b>	<b>Service Rating</b>
<b>Insert Designation:</b>	16-35	17-35	17-35	55	22D	M

#### Contact Locations

Front face of pin insert shown



Contact Number	Contact Hole Locations	
	X Axis	Y Axis
1	-.312	+.086
2	-.312	-.004
3	-.312	-.094
4	-.242	+.221
5	-.234	+.131
6	-.234	+.041
7	-.234	-.049
8	-.234	-.139
9	-.234	-.229
10	-.172	+.279
11	-.156	+.176
12	-.156	+.086
13	-.156	-.004
14	-.156	-.094
15	-.156	-.184
16	-.156	-.274
17	-.089	+.316
18	-.078	+.221
19	-.078	+.131
20	-.078	+.041
21	-.078	-.049
22	-.078	-.139
23	-.078	-.229
24	-.078	-.319
25	.000	+.329
26	.000	+.176
27	.000	+.086

Contact Number	Contact Hole Locations	
	X Axis	Y Axis
28	.000	-.004
29	.000	-.094
30	.000	-.184
31	.000	-.274
32	+.089	+.316
33	+.078	+.221
34	+.078	+.131
35	+.078	+.041
36	+.078	-.049
37	+.078	-.139
38	+.078	-.229
39	+.078	-.319
40	+.172	+.279
41	+.156	+.176
42	+.156	+.086
43	+.156	-.004
44	+.156	-.094
45	+.156	-.184
46	+.156	-.274
47	+.242	+.221
48	+.234	+.131
49	+.234	+.041
50	+.234	-.049
51	+.234	-.139
52	+.234	-.229
53	+.312	+.086
54	+.312	-.004
55	+.312	-.094

All dimensions for reference only. For alternate rotations see page 46 for Series III, page 86 for Series II, and page 114 for Series I.  
 Note: Shown in this catalog are the most common insert patterns for PCB applications. For availability of other arrangements, consult Amphenol Aerospace.

# PCB Contacts 38999, Series I LJT, II JT, III TV

## Insert Arrangements

38999

- III
- II
- I
- SJT
- Access
- Aquacon

Series III, II, I

### INSERT ARRANGEMENT #18-11 / 19-11

Connector Type:	JT MIL-DTL-38999 Series II	LJT MIL-DTL-38999 Series I	Number of Contacts	Contact Size	Service Rating
	18-11	19-11			

#### Contact Locations

Front face of pin insert shown



### INSERT ARRANGEMENT #18-32 / 19-32

Connector Type:	JT MIL-DTL-38999 Series II	LJT MIL-DTL-38999 Series I	Tri-Start MIL-DTL-38999 Series III	Number of Contacts	Contact Size	Service Rating
	18-32	19-32	19-32			

#### Contact Locations

Front face of pin insert shown



Contact Hole Locations			Contact Hole Locations		
Contact Letter	Location		Contact Letter	Location	
	X Axis	Y Axis		X Axis	Y Axis
A	+0.066	+0.353	T	-.066	+0.353
B	+1.189	+0.305	U	.000	+0.230
C	+0.286	+0.217	V	+0.124	+0.193
D	+0.345	+0.098	W	+0.209	+0.095
E	+0.357	-.033	X	+0.228	-.033
F	+0.321	-.160	Y	+0.174	-.151
G	+0.242	-.265	Z	+0.065	-.221
H	+0.130	-.335	a	-.065	-.221
J	.000	-.359	b	-.174	-.151
K	-.130	-.335	c	-.228	-.033
L	-.242	-.265	d	-.209	+0.095
M	-.321	-.160	e	-.124	+0.193
N	-.357	-.033	f	.000	+0.096
P	-.345	+0.098	g	+0.096	.000
R	-.286	+0.217	h	.000	-.096
S	-.189	+0.305	j	-.096	.000

All dimensions for reference only. For alternate rotations see page 46 for Series III, page 86 for Series II, and page 114 for Series I.

Note: Shown in this catalog are the most common insert patterns for PCB applications. For availability of other arrangements, consult Amphenol Aerospace.

# PCB Contacts 38999, Series I LJT, II JT, III TV

## Insert Arrangements

38999

### INSERT ARRANGEMENT #18-35 / 19-35

Connector Type:	JT MIL-DTL-38999 Series II	LJT MIL-DTL-38999 Series I	Tri-Start MIL-DTL-38999 Series III	Number of Contacts	Contact Size	Service Rating
Insert Designation:	18-35	19-35	19-35	66	22D	M

#### Contact Locations

Front face of pin insert shown



### INSERT ARRANGEMENT #20-27 / 21-27

Connector Type:	JT MIL-DTL-38999 Series II	LJT MIL-DTL-38999 Series I	Tri-Start MIL-DTL-38999 Series III	Number of Contacts	Contact Size	Service Rating
Insert Designation:	20-27	21-27	NA	27	20	I

#### Contact Locations

Front face of pin insert shown



All dimensions for reference only. For alternate rotations see page 46 for Series III, page 86 for Series II, and page 114 for Series I.

Note: Shown in this catalog are the most common insert patterns for PCB applications. For availability of other arrangements, consult Amphenol.

# PCB Contacts 38999, Series I LJT, II JT, III TV

## Insert Arrangements

### INSERT ARRANGEMENT #20-35 / 21-35

Connector Type:	JT MIL-DTL-38999 Series II	LJT MIL-DTL-38999 Series I	Tri-Start MIL-DTL-38999 Series III	Number of Contacts	Contact Size	Service Rating
Insert Designation:	20-35	21-35	21-35	79	22D	M

### Contact Locations

Front face of pin insert shown



Contact Hole Locations		
Contact Number	Location	
	X Axis	Y Axis
1	+ .053	+ .426
2	+ .146	+ .404
3	+ .232	+ .362
4	+ .306	+ .302
5	+ .365	+ .227
6	+ .406	+ .141
7	+ .427	+ .048
8	+ .427	- .048

Contact Hole Locations		
Contact Number	Location	
	X Axis	Y Axis
9	+ .406	- .141
10	+ .365	- .227
11	+ .306	- .302
12	+ .232	- .362
13	+ .146	- .404
14	+ .053	- .426
15	- .053	- .426
16	- .146	- .404
17	- .232	- .362
18	- .306	- .302
19	- .365	- .227
20	- .406	- .141
21	- .427	- .048
22	- .427	+ .048
23	- .406	+ .141
24	- .365	+ .227
25	- .306	+ .302
26	- .232	+ .362
27	- .146	+ .404
28	- .053	+ .426
29	.000	+ .323
30	+ .098	+ .322
31	+ .184	+ .280
32	+ .258	+ .220
33	+ .311	+ .141
34	+ .332	+ .048
35	+ .332	- .048
36	+ .311	- .141
37	+ .258	- .220
38	+ .184	- .280
39	+ .098	- .322
40	.000	- .347
41	- .098	- .322
42	- .184	- .280

Contact Hole Locations		
Contact Number	Location	
	X Axis	Y Axis
43	- .258	- .220
44	- .311	- .141
45	- .332	- .048
46	- .332	+ .048
47	- .311	+ .141
48	- .258	+ .220
49	- .184	+ .280
50	- .098	+ .322
51	- .048	+ .241
52	+ .048	+ .241
53	+ .134	+ .199
54	+ .208	+ .139
55	+ .237	+ .048
56	+ .237	- .048
57	+ .208	- .139
58	+ .134	- .199
59	+ .048	- .241
60	- .048	- .241
61	- .134	- .199
62	- .208	- .139
63	- .237	- .048
64	- .237	+ .048
65	- .208	+ .139
66	- .134	+ .199
67	- .048	+ .146
68	+ .048	+ .146
69	+ .125	+ .090
70	+ .155	.000
71	+ .125	- .090
72	+ .048	- .146
73	- .048	- .146
74	- .125	- .090
75	- .155	.000
76	- .125	+ .090
77	.000	+ .053
78	+ .048	- .029
79	- .048	- .029

38999

- III
- II
- I
- SJT
- Access
- Aquacon

Series III, II, I

All dimensions for reference only. For alternate rotations see page 46 for Series III, page 86 for Series II, and page 114 for Series I. Note: Shown in this catalog are the most common insert patterns for PCB applications. For availability of other arrangements, consult Amphenol Aerospace.

# PCB Contacts 38999, Series I LJT, II JT, III TV

## Insert Arrangements

38999

### INSERT ARRANGEMENT #20-41 / 21-41

Connector Type:	JT MIL-DTL-38999 Series II	LJT MIL-DTL-38999 Series I	Tri-Start MIL-DTL-38999 Series III	Number of Contacts	Contact Size	Service Rating
Insert Designation:	20-41	21-41	21-41	41	20	I

#### Contact Locations

Front face of pin insert shown



All dimensions for reference only. For alternate rotations see page 46 for Series III, page 86 for Series II, and page 114 for Series I.  
 Note: Shown in this catalog are the most common insert patterns for PCB applications. For availability of other arrangements, consult Amphenol Aerospace.



# PCB Contacts 38999, Series I LJT, II JT, III TV

## Insert Arrangements

### INSERT ARRANGEMENT #22-35 / 23-35

Connector Type:	JT MIL-DTL-38999 Series II	LJT MIL-DTL-38999 Series I	Tri-Start MIL-DTL-38999 Series III
Insert Designation:	22-35	23-35	23-35

Number of Contacts	Contact Size	Service Rating
100	22D	M

38999

- III
- II
- I
- SJT
- Access
- Aquacon

### Contact Locations

Front face of pin insert shown



Contact Number	Location	
	X Axis	Y Axis
20	-.249	.000
21	-.249	-.095
22	-.249	-.190
23	-.249	-.285
24	-.249	-.380
25	-.166	+.428
26	-.166	+.333
27	-.166	+.238
28	-.166	+.143
29	-.166	+.048
30	-.166	-.047
31	-.166	-.142
32	-.166	-.237
33	-.166	-.332
34	-.166	-.427
35	-.083	+.475
36	-.083	+.380
37	-.083	+.285
38	-.083	+.190
39	-.083	+.095
40	-.083	.000
41	-.083	-.095
42	-.083	-.190
43	-.083	-.285
44	-.083	-.380
45	-.083	-.475
46	.000	+.428
47	.000	+.333
48	.000	+.238
49	.000	+.143
50	.000	+.048
51	.000	-.047
52	.000	-.142
53	.000	-.237
54	.000	-.332
55	.000	-.427
56	+.083	+.475
57	+.083	+.380
58	+.083	+.285
59	+.083	+.190

Contact Number	Location	
	X Axis	Y Axis
60	+.083	+.095
61	+.083	.000
62	+.083	-.095
63	+.083	-.190
64	+.083	-.285
65	+.083	-.380
66	+.083	-.475
67	+.166	+.428
68	+.166	+.333
69	+.166	+.238
70	+.166	+.143
71	+.166	+.048
72	+.166	-.047
73	+.166	-.142
74	+.166	-.237
75	+.166	-.332
76	+.166	-.427
77	+.249	+.380
78	+.249	+.285
79	+.249	+.190
80	+.249	+.095
81	+.249	.000
82	+.249	-.095
83	+.249	-.190
84	+.249	-.285
85	+.249	-.380
86	+.332	+.333
87	+.332	+.238
88	+.332	+.143
89	+.332	+.048
90	+.332	-.047
91	+.332	-.142
92	+.332	-.237
93	+.332	-.332
94	+.428	+.241
95	+.467	+.154
96	+.488	+.061
97	+.415	.000
98	+.488	-.061
99	+.428	-.142
100	+.428	-.237

Contact Number	Location	
	X Axis	Y Axis
1	-.428	+.241
2	-.467	+.154
3	-.488	+.061
4	-.415	.000
5	-.488	-.061
6	-.428	-.142
7	-.428	-.237
8	-.332	+.333
9	-.332	+.238
10	-.332	+.143
11	-.332	+.048
12	-.332	-.047
13	-.332	-.142
14	-.332	-.237
15	-.332	-.332
16	-.249	+.380
17	-.249	+.285
18	-.249	+.190
19	-.249	+.095

Series III, II, I

All dimensions for reference only. For alternate rotations see page 46 for Series III, page 86 for Series II, and page 114 for Series I.  
 Note: Shown in this catalog are the most common insert patterns for PCB applications. For availability of other arrangements, consult Amphenol Aerospace.

# PCB Contacts 38999, Series I LJT, II JT, III TV

## Insert Arrangements

38999

### INSERT ARRANGEMENT #22-55 / 23-55

Connector Type:	JT MIL-DTL-38999 Series II	LJT MIL-DTL-38999 Series I	Tri-Start MIL-DTL-38999 Series III	Number of Contacts	Contact Size	Service Rating
Insert Designation:	22-55	23-55	23-55	55	20	I

#### Contact Locations

Front face of pin insert shown



### INSERT ARRANGEMENT #24-31 / 25-31

Connector Type:	JT MIL-DTL-38999 Series II	LJT MIL-DTL-38999 Series I	Tri-Start MIL-DTL-38999 Series III	Number of Contacts	Contact Size	Service Rating
Insert Designation:	24-31	NA	NA	31	16	I

#### Contact Locations

Front face of pin insert shown



All dimensions for reference only. For alternate rotations see page 46 for Series III, page 86 for Series II, and page 114 for Series I.  
Note: Shown in this catalog are the most common insert patterns for PCB applications. For availability of other arrangements, consult Amphenol Aerospace.

# PCB Contacts 38999, Series I LJT, II JT, III TV

## Insert Arrangements

38999

### INSERT ARRANGEMENT #24-35 / 25-35

Connector Type:	JT MIL-DTL-38999 Series II	LJT MIL-DTL-38999 Series I	Tri-Start MIL-DTL-38999 Series III	Number of Contacts	Contact Size	Service Rating
Insert Designation:	24-35	25-35	25-35	128	22D	M

### Contact Locations

Front face of pin insert shown



Contact Hole Locations		
Contact Number	Location	
	X Axis	Y Axis
1	-.479	+.279
2	-.520	+.190
3	-.546	+.095
4	-.555	.000
5	-.546	-.095
6	-.520	-.190
7	-.479	-.279
8	-.424	+.357
9	-.415	+.190
10	-.415	+.095
11	-.415	.000
12	-.415	-.095
13	-.415	-.190
14	-.424	-.357
15	-.332	+.444
16	-.332	+.332
17	-.332	+.237
18	-.332	+.142
19	-.332	+.047
20	-.332	-.047
21	-.332	-.142
22	-.332	-.237
23	-.332	-.332
24	-.332	-.427
25	-.249	+.496
26	-.249	+.380
27	-.249	+.285
28	-.249	+.190

Contact Hole Locations		
Contact Number	Location	
	X Axis	Y Axis
29	-.249	+.095
30	-.249	.000
31	-.249	-.095
32	-.249	-.190
33	-.249	-.285
34	-.249	-.380
35	-.249	-.475
36	-.166	+.531
37	-.166	+.427
38	-.166	+.332
39	-.166	+.237
40	-.166	+.142
41	-.166	+.047
42	-.166	-.047
43	-.166	-.142
44	-.166	-.237
45	-.166	-.332
46	-.166	-.427
47	-.166	-.522
48	-.083	+.475
49	-.083	+.380
50	-.083	+.285
51	-.083	+.190
52	-.083	+.095
53	-.083	.000
54	-.083	-.095
55	-.083	-.190
56	-.083	-.285
57	-.083	-.380
58	-.083	-.475
59	.000	+.522
60	.000	+.427
61	.000	+.332
62	.000	+.237
63	.000	+.142
64	.000	+.047
65	.000	-.047
66	.000	-.142
67	.000	-.237
68	.000	-.332
69	.000	-.427
70	.000	-.555
71	+.083	+.475
72	+.083	+.380
73	+.083	+.285
74	+.083	+.190
75	+.083	+.095
76	+.083	.000
77	+.083	-.095
78	+.083	-.190

Contact Hole Locations		
Contact Number	Location	
	X Axis	Y Axis
79	+.083	-.285
80	+.083	-.380
81	+.083	-.475
82	+.166	+.531
83	+.166	+.427
84	+.166	+.332
85	+.166	+.237
86	+.166	+.142
87	+.166	+.047
88	+.166	-.047
89	+.166	-.142
90	+.166	-.237
91	+.166	-.332
92	+.166	-.427
93	+.166	-.522
94	+.249	+.496
95	+.249	+.380
96	+.249	+.285
97	+.249	+.190
98	+.249	+.095
99	+.249	.000
100	+.249	-.095
101	+.249	-.190
102	+.249	-.285
103	+.249	-.380
104	+.249	-.475
105	+.332	+.444
106	+.332	+.332
107	+.332	+.237
108	+.332	+.142
109	+.332	+.047
110	+.332	-.047
111	+.332	-.142
112	+.332	-.237
113	+.332	-.332
114	+.332	-.427
115	+.424	+.357
116	+.415	+.190
117	+.415	+.095
118	+.415	.000
119	+.415	-.095
120	+.415	-.190
121	+.424	-.357
122	+.479	+.279
123	+.520	+.190
124	+.546	+.095
125	+.555	.000
126	+.546	-.095
127	+.520	-.190
128	+.479	-.279

All dimensions for reference only. For alternate rotations see page 46 for Series III, page 86 for Series II, and page 114 for Series I.

Note: Shown in this catalog are the most common insert patterns for PCB applications. For availability of other arrangements, consult Amphenol Aerospace.

Series III, II, I

- III
- II
- I
- SJT
- Access
- Aquacon

# PCB Contacts 38999, Series I LJT, II JT, III TV

## Insert Arrangements

38999

III

II

I

SJT

Access

Aquacon

Series III, II, I

### INSERT ARRANGEMENT #24-61 / 25-61

Connector Type:	JT MIL-DTL-38999 Series II	LJT MIL-DTL-38999 Series I	Tri-Start MIL-DTL-38999 Series III	Number of Contacts	Contact Size	Service Rating
Insert Designation:	24-61	25-61	25-61	61	20	I

### Contact Locations

Front face of pin insert shown



Contact Hole Locations			Contact Hole Locations		
Contact Number	Location		Contact Number	Location	
	X Axis	Y Axis		X Axis	Y Axis
A	+ .196	+ .500	h	+ .341	- .213
B	+ .314	+ .435	i	+ .251	- .314
C	+ .413	+ .343	j	+ .133	- .379
D	+ .485	+ .230	k	.000	- .402
E	+ .527	+ .101	m	- .133	- .379
F	+ .536	- .030	n	- .251	- .314
G	+ .511	- .164	p	- .341	- .213
H	+ .454	- .287	q	- .392	- .088
J	+ .368	- .391	r	- .399	+ .046
K	+ .259	- .470	s	- .362	+ .175
L	+ .134	- .519	t	- .285	+ .283
M	.000	- .537	u	- .173	+ .363
N	- .134	- .519	v	.000	+ .338
P	- .259	- .470	w	+ .147	+ .223
R	- .368	- .391	x	+ .237	+ .122
S	- .454	- .287	y	+ .267	- .010
T	- .511	- .164	z	+ .228	- .139
U	- .536	- .030	AA	+ .131	- .233
V	- .527	+ .101	BB	.000	- .267
W	- .485	+ .230	CC	- .131	- .233
X	- .413	+ .343	DD	- .228	- .139
Y	- .314	+ .435	EE	- .267	- .010
Z	- .196	+ .500	FF	- .237	+ .122
a	- .068	+ .454	GG	- .147	+ .223
b	+ .068	+ .454	HH	.000	+ .200
c	+ .173	+ .363	JJ	+ .105	+ .094
d	+ .285	+ .283	KK	+ .135	- .041
e	+ .362	+ .175	LL	.000	- .132
f	+ .399	+ .046	MM	- .135	- .041
g	+ .392	- .088	NN	- .105	+ .094
			PP	.000	.000

All dimensions for reference only. For alternate rotations see page 46 for Series III, page 86 for Series II, and page 114 for Series I.

Note: Shown in this catalog are the most common insert patterns for PCB applications. For availability of other arrangements, consult Amphenol Aerospace.

# MIL-DTL-38999, Series I LJT, II JT, III TV, HD

## Contact Ratings/ Service Ratings

### CONTACT RATING FOR TV III, HD, JT II, LJT I, SJT

Contact Size	Test Current (Amps)		Maximum Millivolt Drop Crimp*	Maximum Millivolt Drop Hermetic*
	Crimp	Hermetic		
23	5	3	73	85
22M	3	2	45	60
22D	5	3	73	85
22	5	3	73	85
20	7.5	5	55	60
16	13	10	49	85
12	23	17	42	85
10 (Power)	33	NA	33	NA
8 (Power)	46	NA	26	NA
4	80	NA	23	NA
0	150	NA	21	NA

\*When tested using silver plated wire.

Contact Size	Crimp Well Data		Solder Well Data	
	Well Diameter	Normal Well Depth	Well Diameter	Nominal Well Depth
23	.0345 ± .0010	.141	.0345 ± .0010	.130
22M	.028 ± .001	.141	.029 +.004 -.000	
22D	.0345 ± .0010	.141	.036 +.004 -.000	.094
22	.0365 ± .0010	.141	.036 +.004 -.000	.094
20	.047 ± .001	.209	.044 +.004 -.004	.125
16	.067 ± .001	.209	.078 +.000 -.004	.141
12	.100 ± .002	.209	.116 +.004 -.002	.141
10 (Power)	.137 ± .002	.355	NA	NA
8	.181 ± .002	.490	NA	NA
4	.281 ± .002	.490	NA	NA
0	.453 ± .002	.585	NA	NA

### MIL-DTL-38999 SERIES III STANDARD 500 CYCLE CONTACTS FOR TV AND CTV, P & S

Contact Size	TV/CTV Pins		TV/CTV Sockets	
	Military No.	Supersedes	Military No.	Supersedes
8 (Coax)*	M39029/60-367	MS27536	M39029/59-366	MS27535
8 (Power)	Contact Factory	"	"	"
8 (Twinax)	M39029/90-529**	N/A	M39029/91-530	N/A
10 (Power)	M39029/58-528	N/A	M39029/56-527	N/A
12	M39029/58-365	MS27493-12	M39029/56-353	MS27490-12
16	M39029/58-364	MS27493-16	M39029/56-352	MS27490-16
20	M39029/58-363	MS27493-20	M39029/56-351	MS27490-20
22D	M39029/58-360	MS27493-22D	M39029/56-348	MS27490-22D
4	N/A	N/A	N/A	N/A
0	N/A	N/A	N/A	N/A

Above part numbers include standard 500 cycle finish designation - gold plating over suitable underplate in accordance with SAE AS39029. For other finish variations, consult Amphenol Aerospace.

\*For use with RG180B/U and RG195A/U cable. For other size 8 coax or optional sizes 12 and 16 coax contacts available for use in Tri-Start connectors, see High Speed catalog or consult Amphenol Aerospace.

### MIL-DTL-38999 SERIES III 1500 CYCLE CONTACTS, CLASSES H & J

Contact Size	CTV Pins			CTV Sockets		
	Commercial No.	Military No.	Supersedes	Commercial No.	Military No.	Supersedes
12	10-597072-2X	M39029/107-623	-	10-597073-2X	M39029/106-617	-
16	10-597068-2X	M39029/107-622	-	10-597069-2X	M39029/106-616	-
20	10-597064-2X	M39029/107-621	-	10-597065-2X	M39029/106-615	-
22D	10-597058-3X	M39029/107-620	-	10-597061-2X	M39029/106-614	-

# MIL-DTL-38999, Series I LJT, II JT, III TV Thermocouple Contacts/Sealing Plugs

38999

III

II

I

SJT

Access

Aquacon

Series III, II, I

## MIL-DTL-38999 SERIES II JT/ SERIES I LJT/SJT SERIES CRIMP CONTACTS

Contact Size	JT/LJT/SJT Pins MS No.	JT Socket MS No.	LJT/SJT Sockets MS No.	Contact Size	JT/LJT Pins MS No.	JT Socket MS No.	LJT/SJT Sockets MS No.
8 (Coax)*	M39029/60-367	NA	M39029/59-366	20	M39029/58-363	M39029/57-357	M39029/56-351
8 (Twinax)	M39029/90-529**	NA	M39029/91-530	22	M39029/58-362	M39029/57-356	M39029/56-350
10 (Power)	M39029/58-528	NA	M39029/56-527	22M	M39029/58-361	M39029/57-355	M39029/56-349
12	M39029/58-365	M39029/57-359	M39029/56-353	22D	M39029/58-360	M39029/57-354	M39029/56-348
16	M39029/58-364	M39029/57-358	M39029/56-352				

## MIL-DTL-38999 SERIES II JT/ I LJT THERMOCOUPLE CONTACTS

Contact Size	Material	JT/LJT Pins	JT Sockets	LJT Sockets
20	Chromel	10-407862-310	10-407863-310	10-407236-310
	Alumel	10-407862-320	10-407863-320	10-407865-320
	Iron	10-407862-335	10-407863-335	10-407865-335
	Constantan	10-407862-342	10-407863-342	10-407865-342

Partial Listing. If you do not see the contact for your application, consult Amphenol Aerospace.

## MIL-DTL-38999 SERIES II JT/ I LJT THERMOCOUPLE CONTACTS PYLE VERSION

Contact Size	Pins (II JT/ I LJT)		Sockets (LJT)		Material
	Spec Number	Pyle Number	Spec Number	Pyle Number	
22D	M39029/87-472	T3-4022-10P	M39029/88-484	T3-4122-10P	CHROMEL
22D	M39029/87-471	T3-4022-10R	M39029/88-483	T3-4122-10R	ALUMEL
20	M39029/87-476	T3-4020-10P	M39029/88-488	TS-4120-10P	CHROMEL
20	M39029/87-475	T3-4020-10R	M39029/88-487	T3-4120-10R	ALUMEL
16	M39029/87-480	T3-4016-10P	M39029/88-492	T3-4116-10P	CHROMEL
16	M39029/87-479	T3-4016-10R	M39029/88-491	T3-4116-10R	ALUMEL

Above part numbers include standard finish designation - gold plating over suitable underplate in accordance with MIL-DTL-39029. For other finishes, consult Amphenol Aerospace. Note: 22M and 22D contacts are interchangeable. \*For use with RG180B/U and RG195A/U cable. For other size 8 coax or optional sizes 12 and 18 coax contacts available for use in JT/LJT connectors, Refer to the High Speed Catalog. \*\* For use with 17/M176-00002 cable.

## MIL-DTL-38999 SERIES III SEALING PLUGS

Contact Size	Commercial No.	Military No.
8 (Coax)	10-482099-8	N/A
8 (Twinax)	T3-4008-59P	N/A
8 (Power)	10-405996-83	MS27488-8-3
10 (Power)	T3-4010-59P	M85049/81-10
12	10-405996-122	MS27488-12-2
16	10-405996-162	MS27488-16-2
20	10-405996-202	MS27488-20-2
22D	10-405996-222	MS27488-22-2
4	10-405996-43	MS27488-4-3
0	10-405996-03	MS27488-0-3

## MIL-DTL-38999 SERIES II JT/ I LJT SEALING PLUGS

Contact Size	Commercial No.	Military No.
8 (Coax)	10-482099-8	MS27488-8
8 (Twinax)	T3-4008-59P	N/A
10 (Power)	10-576225	N/A
12	10-405996-122	MS27488-12-2
16	10-405996-162	MS27488-16-2
20	10-405996-202	MS27488-20-2
22	10-405996-222	MS27488-22-2
22M	10-405996-222	MS27488-22-2
22D	10-405996-222	MS27488-22-2

## SJT SEALING PLUGS

Contact Size	Commercial No.
8 (Coax)	10-482099-8
8 (Twinax)	10-482099-8
10 (Power)	NA
12	10-405996-012 Yellow
16	10-405996-016 Blue
20	10-405996-020 Red
22	10-405996-022 Black
22M	10-405996-022 Black
22D	10-405996-022 Black

\*\* For use with M17/M176-00002 cable.

† Optional design - see slash sheet MS39029.

For other contact options available for use in Tri-Start connectors (wire wrap, thermocouple, fiber optic), consult Amphenol.

# MIL-DTL-38999, Series I LJT, II JT, III TV

## Thermocouple Contacts/Sealing Plugs/Finishing Data

### SERVICE RATING\*\*

Service Rating	Suggested Oper. Voltage (Sea Level)		Test Voltage (Sea Level)	Test Voltage 50,000 Ft.	Test Voltage 70,000 Ft	Test Voltage 110,000 Ft.
	AC (RMS)	DC				
M	400	500	1300 VRMS	550 VRMS	350 VRMS	200 VRMS
N	300	450	1000 VRMS	400 VRMS	260 VRMS	200 VRMS
I	600	850	1800 VRMS	600 VRMS	400 VRMS	200 VRMS
II	900	1250	2300 VRMS	800 VRMS	500 VRMS	200 VRMS

\*\* Please note that the establishment of electrical safety factors is left entirely in the designer's hands, since they are in the best position to know what peak voltage, switching surges, transients, etc. can be expected in a particular circuit.

### FINISH DATA MIL-DTL-38999, TRI-START, SERIES III TV

#### ALUMINUM SHELL COMPONENTS NON-HERMETIC\*

Finish	Service Class	
	Military	Commercial
Anodic Coating (Non-Conductive)	C*	RX**
Electroless Nickel	F (Metal)*	RF
	M (Composite)	
Olive Drab Cadmium Plate Nickel Base	W (Metal)*	RW
	J (Composite)	
Stainless Steel with Nickel Plate (non-firewall)	L	
Stainless Steel with Nickel Plate (firewall)	S	RS
Stainless Steel	K	RK
Durmalon plated	T*	DT
Zinc-Nickel Plated	Z*	DZ
Electroless Nickel Space Grade	G	

\*\*Add Suffix (005) to part number.

#### HERMETIC SHELL COMPONENTS

Material/Finish	Service Class	
	Military	Commercial
Stainless Steel	Y	Y
Stainless Steel with Nickel Plate	N	YN

### FINISH DATA MIL-DTL-38999, SERIES I LJT, II JT

#### ALUMINUM SHELL COMPONENTS NON-HERMETIC

Finish	Suffix		Finish Plus "SR" Suffix	Indicated Finish Standard for JT Types Listed Below	Indicated Finish Standard for LJT Types Listed Below
	Military	Commercial			
Cadmium Plated Nickel Base	MS (A)	-	(SR)	JT/JTG/JTL/JTP	LJT/LJTP
Anodic Coating (Alumilite)	MS (C)	(005)	(300)	JTS/JTPS/JTLS	LJTPS/LJTS
Chromate Treated (Iridite 14-2)		(011)	(344)	JTN/JTPN/JTLN	LJTN/LJTPN
Olive Drab Cadmium Plate Nickel Base	MS (B)	(014)	(386)		
Electroless Nickel	MS (F)	(023)	(424)		
Nickel-PTFE Durmalon		(038)			
Space Grade		(453)			

#### HERMETIC CONNECTORS

Finish	Suffix		Indicated Finish Standard for JT Types Listed Below	Indicated Finish Standard for LJT Types Listed Below
	Military	Commercial		
Carbon Steel Shell Tin Plated Shell and Contacts			JT( )H / JT( )Y JTL( )H / JTL( )Y	LJT( )Y LJT( )H
Carbon Steel Shell Tin Plated Shell and Gold Plated Contacts	MS (D)			
Stainless Steel Shell Gold Plated Contacts	MS (E)	(162)	JTS( )Y JTLS( )Y	LJTS( )Y

# Amphenol RoHS Compliant Platings

## Alternative to Cadmium

38999

### DURMALON™

Amphenol's Answer to EU RoHS/ELV/Cadmium Free Restrictions  
Commercial, industrial & military markets are rapidly moving away from restricted materials such as Cadmium (Cd) & Hexavalent Chromium (Cr(VI)). Both of these restricted materials are toxic and are known carcinogens. Amphenol is offering an alternative finish that complies with all customer requirements tied to these specifications.

MIL-DTL-38999, Rev L has established new service classes for alternative finishes addressing these requirements for Cadmium replacement. Amphenol is using this and European Union Directive 2002/95/EC RoHS (Regulation of Hazardous Substances) as a guide to qualification for all domestic, global, commercial, industrial, & military specifications requiring the reduction or elimination of these restricted materials.

Amphenol has qualified Durmalon, with internal part number coding "DT" finish, which meets or exceeds the 38999 designated class "T" finish, Nickel Fluorocarbon Polymer. Durmalon is also EU RoHS compliant and is Cadmium free, Lead free, and Hexavalent Chromium free.

We also offer additional platings such as "DX", (Durmalon, heavy duty final plate) to support JSF, F-35 program. The DX plating is intended to meet higher corrosion Sulfur Dioxide (SO<sub>2</sub>)/salt fog requirements of JSF.

Cadmium has been applied to numerous components of land, sea and air weapon systems and NASA systems for many years as it provides sacrificial corrosion protection and excellent lubricity for threaded applications.

The Defense Logistics Agency (DLA) has added the following cadmium alternative finishes to MIL-DTL-38999, Rev L (and other connector specs):

- Nickel Fluorocarbon Polymer
- Zinc-Nickel

### AMPHENOL'S DURMALON™

Durmalon, like Olive-Drab Cadmium plating (Class W), meets 500 hours of dynamic salt spray, combined with 500 mating cycles and meets specified millivolt drop shell-to-shell conductivity. Durmalon also meets a 200° C temperature rating. Durmalon has been proven to meet this requirement as well as Potassium Formate-Deicer fluid testing performed by Boeing.

### BLACK ZINC NICKEL

Black Zinc Nickel is Amphenol's 2nd RoHS Compliant Plating Alternative to Cadmium

Amphenol is now offering a new RoHS compliant alternative to Cadmium. Black Zinc Nickel is a non-reflective and conductive black finish approved for 500 hrs salt spray making it an excellent choice for harsh environments. Black Zinc Nickel has been qualified by the DLA, with internal part number coding "DZ" finish, which meets or exceeds the 38999 designated class "Z" finish. Black Zinc Nickel is compatible with other platings and available on a wide variety of connectors and accessories including all MIL-DTL-38999 Series III connectors.

### APPLICATIONS

Interest for non-hazardous alternative finishes are gaining momentum & many customers are currently using Black Zinc Nickel for a broad number of applications. Black Zinc Nickel is typically used on applications for commercial aerospace and military defense, who are now moving away from toxic Cadmium to more environmentally friendly options.

### TESTING

Amphenol Aerospace has performed extensive testing on numerous alternative platings including Black Zinc Nickel. For specific applications please contact Amphenol Aerospace.

**DURMALON™**  
Alternative to Cadmium



### APPLICATIONS

Interest for non-hazardous alternative finishes is gaining momentum & many customers are currently using Durmalon for a broad number of applications. Durmalon combines the unique lubrication and anti-wetting properties of PTFE with corrosion resistance, high conductivity and EU RoHS compliance in a non-reflective finish.

### TESTING

Amphenol Aerospace has performed extensive testing on numerous alternative platings with the most consistent performer being the Durmalon. For specific applications please contact Amphenol Aerospace.

Requirements	Cadmium	Durmalon™	Black Zinc Nickel
<b>Coupling Torque</b> Post 500 hr. salt	■	■	■
<b>Shell to Shell Conductivity</b> <2.5 millivolts	■	■	■
<b>Cycles of Durability</b> 500 mates	■	■	■
<b>Salt Spray</b> Dynamic 500 hours	■	■	■
<b>Temperature Rating</b> 175° C	■	■	■
Non-Reflective	■	■	■
EU RoHS/ELV Compliant*		■	■
Non-Magnetic	■	■	■
De-icing Fluid**		■	■

\* Meets EU RoHS/ELV maximum concentration values (MCV) of 1000 ppm (0.1% w/w) or (0.01% w/w) per homogenous material.

\*\* Potassium Formate/Acetate based de-icing fluids.

Note: Specifications are subject to change without notice.

Series III

A



# A



## TABLE OF CONTENTS FOR SECTION A

Combined MIL-DTL-38999 Series I, II, III	
Shell Size & Insert Arrangements Availability	2-5
Insert Arrangement Drawings	6-13
PCB Insert Arrangements	14-28
Contact - Ratings, Service Ratings, Finish Data	29-31
Amphenol RoHS Compliant Plating	32

### MIL-DTL-38999, Series III TV

Performance, Options	34, 35
Test Data	36
Weight Comparison (Composite vs. Metal)	37
Dualok	38
HD38999, High Density	39
Custom	40
Configurator	41
How to Order (Military & Commercial)	42-46
How to Order (Boeing BACC63)	47

## TV SHELL STYLES:

Crimp Wall Mounting Receptacle TVP00R (D38999/20) /CTVP00R (Military D38999/20)	48
Crimp Box Mounting Receptacle TVP02R / CTVP02R	49
Line Receptacle TV01, TVS01, CTV01, CTVS01	50
Crimp Jam Nut Receptacle TV07R (D38999/24) / CTV07R (Military D38999/24)	51
Straight Plug TV06, TVS06, CTV06, CTVS06 (Military D38999/26)	52
Crimp Flange Mounting Plug TV09R	53
Dualok Plug/Receptacle TV56, TVS56, CTV56, CTVS56	54
Crimp CLUTCH-LOK™ Straight Plug for High Vibration TV26/MTV26	55

## PCB:

PCB Wall Mounting, Back Panel TVP00, TVPS00	56
PCB Wall Mounting, Back Panel, Clinch Nuts, TVP10, TVPS10	57
PCB Wall Mounting, Double Flange, TVP40, TVPS40	58
PCB Box Mounting Receptacle, TVP02, TVPS02	59
PCB Box Mounting Receptacle, Clinch Nuts, TVP12, TVPS12	60
PCB Jam Nut Receptacle, TV07, TVS07	61
PCB Jam Nut Receptacle, Double Flange, TVP47, TVPS47	62
PCB Hermetic Box, Jam Nut, Solder, Weld Mounting	63-66

## HERMETIC:

Hermetic Box Mounting TVPS02Y(D38999/21)	.67
Hermetic Jam Nut Receptacle TVS07Y (D38999/23)	.68
Hermetic Solder Mounting TVSIY (D38999/25)	.69
Hermetic Weld Mounting TVSHIY (D38999/27)	.69

## BREAKAWAY:

Breakaway Fail-Safe Connectors	.70
How to Order Breakaway (Military)	71, 72
How to Order Breakaway (Commercial)	.73
Fail-Safe Lanyard Release Plug	.74
How to Order Breakaway MIL-STD-1760 (Military)	.75
TV Breakaway (D38999/31) for MIL-STD-1760	.76
TV Breakaway Commercial Version for D38999/31, Type 6	.77
How to Order Commercial Version D38999/31, Type 6	.78
Insert Arrangements for Breakaway Fail-Safe	.79
Breakaway Fail-Safe 88-725041, 88-725014	.80
Breakaway Hybrid, Low Profile Lanyard Release Plug	.81
Stores Management Type II, Rail Launch (MIL-STD-1760)	.81

## Accessories:

Section F	164-183
-----------	---------

# MIL-DTL-38999, Series III TV

## Performance

38999

III

II

I

SJT

Access

Aquacon

Series III

### TRI-START™ MIL-DTL-38999 SERIES III WITH METAL SHELLS - ALUMINUM, STAINLESS STEEL, CLASS K FIREWALL

Amphenol® Tri-Start MIL-DTL-38999\* Series III Connectors offer the highest performance capabilities for both general duty and severe environment applications. Meeting or exceeding MIL-DTL-38999 Series III requirements, the Tri-Start connector with standard metal shells (aluminum or stainless steel with several finish options) offers these features:

- **EMI Shielding** - solid metal-to-metal coupling, grounding fingers, electroless nickel plating, and thicker wall sections provide superior EMI shielding capability of 65dB minimum at 10 GHz
- **Contact Protection** - recessed pins in this 100% scoop-proof connector minimize potential contact damage
- **Moisture Resistance** - improved interfacial seal design helps prevent electrolytic erosion of contacts
- **Corrosion Resistance** - shells of stainless steel or cadmium over nickel plating withstand a 500 hour salt spray exposure
- **Vibration/Shock** - operates under severe high temperature vibration, through 200°C
- **Firewall Capability** - available in a stainless steel shell, class RK, RS
- **Lockwiring Eliminated** - unique, self-locking, quick coupling connector eliminates lockwiring
- **Quick Coupling** - completely mates and self-locks in a 360° turn of the coupling nut
- **Inventory Support Commonality** - uses standard MIL-DTL-38999 contacts, application tools, insert arrangements
- **Electrostatic Discharge Protection (ESD)** - protection for sensitive circuitry without diodes, varistors, etc., with the use of the Faraday Cage principle which shunts high voltage, high current discharge events (see page Amphenol Filter Section)
- **Hermetic**- air leakage limited to  $1 \times 10^{-7}$  cm<sup>3</sup> per second optional
- **Qualified Specifications** - Stainless Steel qualified to BACC63DB and BACC63DC specifications



PASSIVATED STAINLESS STEEL



ELECTROLESS NICKEL



OLIVE DRAB CADMIUM



DURALON PLATED



ZINC NICKEL PLATED

### OFFER MORE VERSATILITY & OPTIONS THAN ANY OTHER INTERCONNECTION FAMILY!



HD38999

High reliability and increased versatility best describe Amphenol MIL-DTL-38999, Series III circular connectors. Originally designed for the harshest of environments and most demanding of applications, Amphenol MIL-DTL-38999 Series III, Tri-Start connectors continue to evolve in pace with the needs of an ever-changing market.



DUALOK

Amphenol Tri-Start connectors can be configured with a number of application specific technologies like:

- High Density HD38999
- Dualok
- PC Tails
- Filters
- Fail Safe
- CLUTCH-LOK
- Fiber Optics
- High Speed Contacts
- Hermetics
- Flex



FILTER



PC TAILS



FAIL SAFE

Flexibility aids in design optimization through the combination of different technologies within a common, time-tested, harsh environment connector body.



CLUTCH-LOK

For more information about options, please call 800-678-0141 or visit [www.amphenol-aerospace.com](http://www.amphenol-aerospace.com).



FIBER OPTICS



HIGH SPEED



HERMETIC



FLEX



Composite Connector Patents:  
4,268,103; 4,648,670; 4,682,832; 4,703,987.  
Clutch-Lok® Patent 6,152,753.

38999

III

II

I

SJT

Access

Aquacon

Series III

A

# MIL-DTL-38999, Series III TV, HD

## Test Data

### TRI-START, SERIES III TYPICAL SHIELDING EFFECTIVENESS TEST DATA

EMI/EMP SHIELDING EFFECTIVENESS dB  
TESTING BY TRIAXIAL METHOD



### AMPHENOL® TRI-START CONNECTORS PROVIDE EMI/ EMP SHIELDING CAPABILITY WHICH EXCEEDS MIL-DTL-38999 SERIES III REQUIREMENTS.

The TV and CTV Series III connector with standard solid metal-to-metal coupling, EMI grounding fingers and conductive finishes have proven to be the ultimate in EMI/EMP shielding effectiveness. The charts illustrate shielding effectiveness data which is typical of Tri-Start connectors tested with the nickel finish (Class F-metal, Class M-composite) over a wide frequency range.

The vibration capability of the Tri-Start Series is shown in the chart below. This illustrates the most severe vibration envelope of any qualified connector available today.

These capabilities along with a +200°C, -65°C temperature rating and superior moisture sealing protection provide the user with a connector that can withstand the most rigorous application.

### TRI-START, SERIES III TYPICAL SHIELDING EFFECTIVENESS TEST DATA

EMI/EMP SHIELDING EFFECTIVENESS dB  
TESTING BY MODE STIRRING METHOD



### TRI-START VIBRATION CRITERIA



\* Dependant on shell finish

Test data beyond 2GHz is subject to equipment variation.

NOTE: For test data information on the new Clutch-Lok Tri-Start, high vibration connectors, consult Amphenol Aerospace.

# MIL-DTL-38999, Series III TV

## Weight Comparisons (Composite vs. Metal)

Depending on the shell style, shell size and contact count, weight savings can range from 17% to 40% compared to standard aluminum product.  
**Tri-Start Weight in Ounces** (includes contacts)

	Wall Mount Receptacle (00) + Military D38999/20						Jam Nut Receptacle (07) + Military D38999/24						Plug (06) + Military D38999/26					
	Stainless Steel		Aluminum		Composite		Stainless		Aluminum		Composite		Stainless Steel		Aluminum		Composite	
	Pin	Socket	Pin	Socket	Pin	Socket	Pin	Socket	Pin	Socket	Pin	Socket	Pin	Socket	Pin	Socket	Pin	Socket
9-35	.7216	.7840	.3248	.3777	.2588	.3121	1.1472	1.2096	.4416	.5040	.3489	.4413	1.0736	1.1360	.4236	.4625	.2606	.2994
9-98	.7216	.7776	.2496	.3056	.1664	.2224	1.1472	1.2032	.4416	.4976	.3744	.4640	1.0736	1.1296	.3968	.4624	.2991	.2337
11-35	.9488	1.0800	.3632	.4960	.2753	.4081	1.4304	1.5632	.5936	.7264	.4679	.6007	1.2480	1.3808	.5312	.6389	.3450	.4582
11-98	.9488	1.0620	.3632	.4768	.2753	.3889	1.4304	1.5440	.5936	.7072	.4679	.5815	1.2480	1.3616	.5330	.6283	.3468	.4457
13-8	1.2096	1.3888	.4800	.6592	.3696	.5488	1.9104	2.0896	.7664	.9456	.6560	.8352	1.8048	1.9840	.7936	.9728	.5237	.5952
13-35	1.2160	1.4320	.4864	.7024	.3762	.5922	1.9168	2.1328	.7728	.9888	.6136	.8296	1.8112	2.0272	.8000	.8472	.5301	.6531
13-98	1.2160	1.4016	.4864	.6720	.3762	.5618	1.9168	2.1024	.7728	.9584	.6136	.7992	1.8112	1.9968	.7978	.9856	.5244	.7157
15-5	1.5312	1.7904	.6352	.8944	.5027	.7619	2.3792	2.6384	.9728	1.2320	.7749	1.0341	2.2704	2.5456	.9632	1.1719	.6450	.8467
15-18	1.5456	1.8416	.7760	.9456	.6432	.8128	2.3936	2.6896	.9872	1.2832	.8544	1.1504	2.2848	2.5808	.9776	1.2736	.6594	.8208
15-35	1.5424	1.8768	.6464	.9808	.5139	.8483	2.3904	2.7344	.9840	1.3280	.7861	1.1301	2.2816	2.6256	1.2179	1.3184	.8961	1.0002
17-6	2.1488	2.5904	.9360	1.3776	.7812	1.2228	2.9152	3.3568	1.2336	1.6752	.9940	1.4356	2.5008	3.1024	1.1408	1.7424	.8160	1.4176
17-26	2.1344	2.5600	.9216	1.3472	.7668	1.1924	2.9008	3.3264	1.2192	1.6448	.9796	1.4052	2.4864	2.9120	1.1264	1.3343	.8017	.8062
17-35	2.1360	2.6640	.9232	1.4512	.7684	1.2964	2.9024	3.4304	1.2208	1.7488	.9812	1.5092	2.4880	3.0160	1.1280	1.5497	.8033	1.2144
19-11	2.2592	2.6656	.9696	1.4528	.7925	1.2757	3.4352	3.9184	1.4720	1.9552	1.2033	1.6865	2.9808	3.4640	1.3472	1.8304	.9632	1.4464
19-32	2.1888	2.7264	.9760	1.5136	.7989	1.3365	3.4416	3.9792	1.4784	2.0160	1.2097	1.7473	2.9872	3.5248	1.3536	1.8912	.9696	1.5072
19-35	2.1920	2.8432	.9792	1.6304	.8021	1.4533	3.4448	4.0960	1.4816	2.1328	1.2129	1.8641	2.9904	3.6416	1.3568	2.0080	.9728	1.6240
21-11	2.7456	3.4640	1.3088	2.0272	1.1088	1.8272	3.9712	4.6896	1.8128	2.5312	1.6128	2.3312	3.4448	4.1632	1.7344	2.5312	1.3039	1.8710
21-16	2.6784	3.3168	1.2416	1.8800	1.0422	1.6806	3.9040	4.5424	1.7456	2.3840	1.4505	2.0889	3.3776	4.0160	1.6672	2.3168	1.2352	1.8736
21-35	2.6672	3.4992	1.2304	2.0624	1.0310	1.8630	3.8928	4.7248	1.7344	2.5664	1.4393	2.2713	3.3664	4.1984	1.6560	2.2309	1.2255	1.8003
21-41	2.6768	3.3600	1.2400	1.9232	1.0406	1.7238	3.9024	4.5856	1.7440	2.4272	1.4489	2.1321	3.3760	3.5792	1.6656	1.8688	1.2336	1.4368
23-21	3.0352	3.8624	1.4496	2.2768	1.2279	2.0551	4.2368	5.0640	1.9440	2.7712	1.6368	2.4640	3.7920	4.6192	1.9216	2.7488	1.4637	2.2896
23-35	3.0240	4.0448	1.4384	2.4592	1.2167	2.2375	4.2256	5.2464	1.9328	2.9536	1.6256	2.6464	3.7808	4.8016	1.9104	2.6087	1.4525	2.1507
23-53	2.8992	3.9072	1.4560	2.4816	1.2343	2.2599	4.2432	5.1088	1.9504	2.8160	1.6432	2.5088	3.7984	4.6640	1.9280	2.7936	1.4672	2.2384
25-4	3.4512	4.4800	1.7312	2.8816	1.4864	2.1904	4.8048	5.8272	2.2016	3.2480	1.9568	2.8720	4.2224	5.2496	2.2128	3.2560	1.7133	2.4163
25-19	3.5312	4.7264	1.8112	3.0064	1.5664	2.7616	4.8848	6.0816	2.2816	3.4784	2.0368	3.2336	4.3024	5.4992	2.2928	3.4896	1.7933	2.7058
25-20	3.8190	4.7150	2.0173	3.1125	1.7733	2.8512	5.1430	6.0380	2.4877	3.5421	2.1872	3.2416	4.4350	5.3300	2.2580	3.0182	1.8288	2.8928
25-35	3.4416	4.6656	1.7216	2.9456	1.4776	2.7016	4.7952	6.0192	2.1920	3.4160	1.8915	3.1155	4.2128	5.4368	2.2032	3.4272	1.7037	2.9277
25-61	3.4304	4.4848	1.7282	2.7648	1.4841	2.5208	4.7840	5.8384	2.1808	3.2352	1.8803	2.9347	4.2016	5.2560	2.1920	3.2464	1.6912	2.7456

All weight measurements are for reference only.

# High Vibration Dualok, 38999 Series III Type

## Features and Benefits

38999

The Dualok represents the latest in high performance connector designs from Amphenol. Featuring a newly developed locking mechanism, the Dualok plug ensures rock-solid coupling and metal-to-metal bottoming in the most severe vibration environments.

### DUALOK FEATURES AND BENEFITS INCLUDE:

- Mates with standard D38999 receptacles and utilizes standard D38999 inserts.
- Designed to withstand and stay mated under vibration levels that exceed MIL-DTL-38999 levels
- Dualok stainless steel provides a weight savings of up to 42% compared to standard D38999 stainless steel designs
- Stainless steel, aluminum, composite, or aluminum bronze materials of construction
- Dualok aluminum provides ~ 10% weight reduction over D38999 Aluminum
- Coupling mechanism that does not “settle” under vibration levels exceeding MIL-DTL-38999
- Metal-to-metal bottoming for maximum EMI shielding under extreme vibration

New High Vibration Dualok Connector



Weight Comparison Size #9 (Less Inserts)



### CLUTCH-LOK™ MIL-DTL-38999, SERIES III HIGH VIBRATION CONNECTOR



### OPTIONAL SHELL GEOMETRIES

Amphenol offers a number of different shell configurations to fit your needs

- Deep Reach Shells - For increased panel thickness
- Stand-off Flange Shells - For attachments to Printed Circuit Boards.
- Connector with Integral Strain Reliefs

The Tri-Start option CLUTCH-LOK offers all advantages of stainless steel/Class K firewall for MIL-DTL-38999 Series III connectors, plus a unique clutch design that actually tightens itself under vibration.

Features include:

- High degree of differential torque
- No settling back to the next ratchet tooth
- Completely intermateable with all existing MIL-DTL-38999
- Series III connectors
- Offers advantage in inaccessible, hard to reach areas where mating torque is difficult to apply and complete coupling is not verifiable by inspection

See page 34 for description,  
44 – 46 for ordering.



Series III

A

# High Density Interconnects

## HD38999: 9 to 187 Contacts

The HD38999 family of connectors has 30% more contact density than the highest density Mil Spec 38999 connectors of its size. This series of connectors was designed to utilize mil-specified 38999 components with the exception of the contacts and inserts arrangement. Utilizing existing mil-qualified 39029 size 23 contacts and 38999 insert materials, these connectors are essentially a drop-in replacement for the standard 38999 connector.

This connector design benefits users in a couple of different ways. For those users who need to increase the amount of contacts in their application, the HD38999 series allows them to do so without increasing the size of their connector. For users who are looking to decrease the overall size of their system, they can do so by using smaller shell sizes without decreasing the number of contacts.

Amphenol has qualified this series of connectors to the requirements of MIL-DTL-38999. Amphenol also manufactures this high density series in Filter, Hermetic and customized versions to fit our customer's needs. Please contact us if additional information is required.

### TECHNICAL DATA

HD38999 series was designed to meet and/or exceed the specifications of MIL-DTL-38999. The connector series has been tested to all the requirements of 38999 with the use of AS39029 size 23 contacts. Test reports are available upon request. The following is a summary of some of the performance requirements.

#### EMI SHIELDING EFFECTIVENESS:

Solid metal to metal coupling, EMI grounding fingers and conductive finishes have proven to be the ultimate in EMI/EMP shielding effectiveness. The following chart illustrated shielding effectiveness data which is typical in HD38999 connectors.



#### ELECTRICAL:

22 AWG: 5.0 AMPS  
24 AWG: 3.0 AMPS  
26 AWG: 2.0 AMPS  
28 AWG: 1.5 AMPS

Insulation Resistance: 5000 megohms min. @500 VDC 25C  
Dielectric Withstanding Voltage: 1000 VRMS@sea level

#### MECHANICAL:

**Metallic Shells:** Material: Aluminum alloy, Stainless Steel  
Protection: Electroless Nickel, O.D. Cadmium, Durmalon (Nickel PTFE), Zinc Nickel

**Composite Shells:** Material: Thermoplastic  
Protection: Electroless Nickel, O.D. Cadmium, Durmalon (Nickel PTFE), Zinc Nickel

**Contacts:** Material: Copper Alloy  
Protection: Gold over Nickel

**Insert Retention to Shell:** 100 psi in axial load

**Durability:** 500 full mating and unmating cycles

**Vibration:** 60G sine per MIL-DTL-38999L Para 4.5.23.2.1  
5G2 Random per EIA-364-28E, Test condition A  
1G2 Random per EIA-364-28E, Test condition I

**Shock:** Per EIA-364-27B, 300g

#### ENVIRONMENTAL:

**Operating Temperature:** -65°C to +175°C

**Salt Spray:**  
**Metallized:** Electroless Nickel: 48 hours  
Anodic Coating, O. D. Cadmium, Durmalon, Zinc Nickel: 500 hours

**Salt Spray Composite:** Electroless Nickel: 1000 hours  
O. D. Cadmium, Durmalon, Zinc Nickel: 500 hours



38999

- III
- II
- I
- SJT
- Access
- Aquacon

Series III

A

# Custom Designed HD38999 Connectors and Alignment Disks

38999

NEW CUSTOM DESIGNED HD38999 CONNECTORS - PROVIDE MORE INTERCONNECT SOLUTIONS:



## ALIGNMENT DISKS

Alignment disks keep contacts aligned for easier insertion into circuit boards. These are typically ordered with the connector - see step 7 of How to Order on page 47.



## FILTERED HD38999 CONNECTORS - FOR EMI/EMP PROTECTION

High density patterns are available in filter 38999 connectors - consult Amphenol Aerospace for ordering.



Shell Size	D Dia. ±.010
9	.234
11	.350
13	.500
15	.725
17	.750
19	.850
21	.953
23	1.147
25	1.250

## HD38999 FOR GIGABIT ETHERNET APPLICATIONS

The HD38999 is available for high speed (Gigabit Ethernet) data transmission in the size 9-9 insert pattern.

Data transmission performance of this connector insert:

- 10 Base T, 100 Base TX, and 1000 Base T networks using Cat 5e per TIA/EIA568B and Class D per ISO/IEC 11801.  
(Test report available - consult Amphenol Aerospace for more information)

Signal-Ground Pin Configuration  
Wiring Recommendations



View Rear of Connector



HD38999 Connector with 9-9 Insert Pattern (Rear View)

Series III

A



# MIL-DTL-38999, Series III TV, Configurator

Online at [www.amphenol-aerospace.com](http://www.amphenol-aerospace.com)

Now you can build a part number for Military and Commercial MIL-DTL-38999 Series III through our online configurator, located on the home page of [www.amphenol-aerospace.com](http://www.amphenol-aerospace.com).

38999

III

II

I

SJT

Access

Aquacon

Series III



After building a part number, you have the option to download the drawing and specifications, buy if available through distribution channels, Request a Quote and the ability to download multiple part numbers to a list to manage your needs.



# Military to Commercial Shell Style Conversion Table

## How to Order (Military)

38999

MILITARY	DESCRIPTION	COMMERCIAL
D38999/20	Wall Mounting Receptacle	TVP00 or TVPS00 (AL & SS); CTVP00, CTVPS00 (Composite)
D38999/21	Hermetic Box Mounting Receptacle	TVPS02Y, TVPS02YN
D38999/23	Hermetic Jam Nut Receptacle	TVS07Y, TVS07YN
D38999/24	Jam Nut Receptacle	TV07, TVS07 (AL & SS); CTV00, CTVS00 (Composite)
D38999/26	Straight Plug	TV06, TVS06
D38999/25	Solder Mount Receptacle (Hermetic)	TVSI
D38999/27	Weld Mounted Receptacle (Hermetic)	TVSHI

### HOW TO ORDER: MILITARY

- 1.
- 2.
- 3.
- 4.
- 5.
- 6.

Connector Type	Shell Style	Service Class	Shell Size- Insert Arrangement	Contact Type	Alternate Keying Position
D38999/	20	J	G35	P	N

#### 1. CONNECTOR TYPE

38999/	MIL-DTL-38999 III
--------	-------------------

#### 2. SHELL STYLE

20	Wall Mount Receptacle
21	Box Mount Receptacle Hermetic
26	Straight Plug
24	Jam Nut Receptacle
23	Jam Nut Receptacle Hermetic
25	Solder Mount Receptacle Hermetic
27	Weld Mounted Receptacle, (Hermetic) Only

#### 3. SERVICE CLASS

Military	Finish	RoHS	Material	Material/ Description
C	Anodic Coating	■	Aluminum	200°C, 500 hour salt spray
F	Electroless Nickel	■	Aluminum	200°C, EMI shielding -65dB @ 10GHz, 48 hour salt spray
G	Electroless Nickel	■	Aluminum	200°C, Space grade, 48 hour salt spray
J	Olive Drab Cadmium		Composite	175°C, 2000 hours dynamic salt spray, EMI Shielding -50 dB@10 GHz specification min.
K	Passivated Stainless Steel	■	Stainless Steel	200°C, firewall capability, 500 hour salt spray resistance, EMI -45 dB @ 10 GHz specification min.
L	Stainless Steel w/ Nickel Plate	■	Stainless Steel	Corrosion resistant steel, 200°C, 500 hour salt spray, , non firewall, EMI shielding -65dB @ 10GHz specification min.
M	Electroless Nickel	■	Composite	200°C, EMI shielding -65dB @ 10GHz, 2000 hours dynamic salt spray
N	Stainless Steel w/ Nickel Plate	■	Stainless Steel	Hermetic connectors, corrosion resistant steel, 200°C
S	Stainless Steel w/ Nickel Plate	■	Stainless Steel	Non-hermetic connectors, corrosion resistant steel, 200°, firewall capability, 500 hour salt spray, EMI shielding -65dB @ 10GHz specification min.
T	Durmalon plated	■	Aluminum	Nickel-PTFE alternative to Cadmium, 175°C, 500 hour salt spray, EMI -50dB at 10GHz specification min.
W	Olive Drab Cadmium		Aluminum	175°C , 500 hour salt spray, EMI Shielding -50 dB@10 GHz specification min.
Y	Stainless Steel	■	Stainless Steel	Hermetic seal, 200°C passivated stainless steel
Z	Zinc-Nickel Plated	■	Aluminum	Zinc-Nickel Alternative to Cadmium, +175°C, 500 hour salt spray, EMI Shielding -50 dB @ 10 GHz specification min.

Series III

A

### 4. SELECT A SHELL SIZE & INSERT ARRANGEMENT SEE PAGES 2-5

Shell Size & Insert Arrangements are on pages 2-5. First number represents Shell Size, second number is the Insert Arrangement.

Triple Start Threads									Mil Shell Size
A	B	C	D	E	F	G	H	J	Amphenol Shell size
9	11	13	15	17	19	21	23	25	

### 5. CONTACT TYPE

<b>P</b>	500 Cycle Pin Contacts, if require Less Contacts place (LC) at the end of part number
<b>S</b>	500 Cycle Socket Contacts, if require Less Contacts place (LC) at the end of part number
<b>H</b>	1500 Pin Cycle Contacts
<b>J</b>	1500 Socket Cycle Contacts
<b>A</b>	Less Pin Contacts
<b>B</b>	Less Socket Contacts
<b>X</b>	Eyelet contacts, hermetics only

### 6. ALTERNATE KEY POSITION

Key/Keyway Position					
N	A	B	C	D	E

#### KEY/KEYWAY POSITION

A plug with a given rotation letter will mate with a receptacle with the same rotation letter. The angles for a given connector are the same whether it contains pins or sockets. Master key stays fixed, minor keys rotate. Inserts are not rotated in conjunction with the master key/keyway.

#### RECEPTACLE (front face shown)



#### PLUG (front face shown)



Shell Size	Key & Keyway Arrangement Identification Letter	AR° or AP° BSC	BR° or BP° BSC	CR° or CP° BSC	DR° or DP° BSC
A (9)	N*	105	140	215	265
	A	102	132	248	320
	B	80	118	230	312
	C	35	140	205	275
	D	64	155	234	304
B (11) C (13) D (15)	N*	95	141	208	236
	A	113	156	182	292
	B	90	145	195	252
	C	53	156	220	255
	D	119	146	176	298
E (17) F (19)	N*	80	142	196	293
	A	135	170	200	310
	B	49	169	200	244
	C	66	140	200	257
	D	62	145	180	280
G (21) H (23) J (25)	N*	80	142	196	293
	A	135	170	200	310
	B	49	169	200	244
	C	66	140	200	257
	D	62	145	180	280
	E	79	153	197	272

# MIL-DTL-38999, Series III TV

## How to Order (Commercial)

38999

### 1. SELECT A TYPE & CLASS

1.	2.	3.	4.	5.	** If Required
Type & Class	Shell Size-Insert Arrg.	Contact Type	Alternate Position	PCB Length**	
TVPS00RB-					

	ALUMINUM						
	Electroless Nickel	Olive Drab Cadmium	Durmalon	Black Zinc	Electroless Nickel (With Ground Plane)	Olive Drab Cadmium (With Ground Plane)	Marine Bronze
Temperature	200°C	175°C	175°C	175°C	200°C	175°C	200°C
Salt Spray	48 Hrs	500 Hrs	500 Hrs	500 Hrs	48 Hrs	500 Hrs	2,000 Hrs
EMI Shielding	-65dB @ 10GHz	-65dB @ 10GHz	-50dB @ 10GHz	-50dB @ 10GHz	-65dB @ 10GHz	-65dB @ 10GHz	-65dB @ 10GHz
RoHS							

RATES

Receptacle	Wall Mounting Receptacle	TVPS00RF-	TVP00RW-	TVP00DT-	TVP00DZ-	TVP00RGF-	TVP00RGW-	TVPS00RB-
	Box Mounting Receptacle	TVPS02RF-	TVP02RW-	TVP02DT-	TVP02DZ-	TVP02RGF-	TVP02RGW-	TVPS02RB-
	Line Receptacle	TVS01RF-	TV01RW-	TV01DT-	TV01DZ-	TV01RGF-	TV01RGW-	TVS01RB-
	Jam Nut Receptacle	TVS07RF-	TV07RW-	TV07DT-	TV07DZ-	TV07RGF-	TV07RGW-	TVS07RB-

CONNECTOR TYPE & STYLE

Plugs	Straight Plug	TVS06RF-	TV06RW-	TV06DT-	TV06DZ-	TV06RGF-	TV06RGW-	TVS06RB-
	Flange Mounted Plug	TVS09RF-	TV09RW-	TV09DT-	TV09DZ-	TV09RGF-	TV09RGW-	TVS09RB-
	Straight Plug w Dualok	TVS56RF-	TV56RW-	TV56DT-	TV56DZ-	TV56RGF-	TV56RGW-	TVS56RB-
	Straight Plug w Clutch-Lok*	-	-	-	-	-	-	-

\* Stamped with Mil-Spec #D38999

Printed Circuit Board	Wall Mounting Receptacle	TVPS00RF-	TVP00RW-	TVP00DT-	TVP00DZ-	-	-	TVPS00RB-
	Box Mounting Receptacle	TVPS02RF-	TVP02RW-	TVP02DT-	TVP02DZ-	-	-	TVPS02RB-
	Jam Nut	TVS07RF-	TV07RW-	TV07DT-	TV07DZ-	-	-	TVS07RB-
	Wall Mount (Double Flange)	TVPS40RF-	TVP40RW-	TVP40DT-	TVP40DZ-	-	-	TVPS40RB-
	Jam Nut (Double Flange)	TVS47RF-	TV47RW-	TV47DT-	TV47DZ-	-	-	TVS47RB-
	Wall Mount (Clinch Nuts)	TVPS10RF-	TVP10RW-	TVP10DT-	TVP10DZ-	-	-	TVPS10RB-
	Box Mount (Clinch Nuts)	TVPS12RF-	TVP12RW-	TVP12DT-	TVP12DZ-	-	-	TVPS12RB-

Hermetic	Box Mounting Receptacle	Hermetic only available in Stainless Steel
	Jam Nut Receptacle	
	Solder Mount	
	Wall Mounting Receptacle	

Insert arrangements using multi-axial (i.e. coax, twinax, triax shielded) contacts should not be used in firewall applications.

\*Coaxial arrangements are not available in firewall classes.



A

# MIL-DTL-38999, Series III TV

## How to Order (Commercial)

COMPOSITE				STAINLESS STEEL			
Electroless Nickel	Olive Drab Cadmium	Electroless Nickel (With Ground Plane)	Olive Drab Cadmium (With Ground Plane)	Passivated (Firewall)	Passivated (Non-Firewall)	Nickel Plated (Firewall)	Nickel Plated (Non-Firewall)
200°C	175°C	200°C	175°C	200°C	200°C	200°C	200°C
2,000 Hrs	2,000 Hrs	2,000 Hrs	2,000 Hrs	500 Hrs	500 Hrs	500 Hrs	500 Hrs
-65dB @ 10GHz	-65dB @ 10GHz	-65dB @ 10GHz	-65dB @ 10GHz	-65dB @ 10GHz	-65dB @ 10GHz	-65dB @ 10GHz	-50dB @ 10GHz

CTVPS00RF-	CTVP00RW-	CTVP00RGF-	CTVP00RGW-	TVPS00RK-	TVPS00RKN-	TVPS00RS-	TVPS00RL-
CTVPS02RF-	CTVP02RW-	CTVP02RGF-	CTVP02RGW-	TVPS02RK-	TVPS02RKN-	TVPS02RS-	TVPS02RL-
CTVS01RF-	CTV01RW-	CTV01RGF-	CTV01RGW-	TVS01RK-	TVS01RKN-	TVS01RS-	TVS01RL-
CTVS07RF-	CTV07RW-	CTV07RGF-	CTV07RGW-	TVS07RK-	TVS07RKN-	TVS07RS-	TVS07RL-

CTVS06RF-	CTV06RW-	CTV06RGF-	CTV06RGW-	TVS06RK-	TVS06RKN-	TVS06RS-	TVS06RL-
CTVS09RF-	CTV09RW-	CTV09RGF-	CTV09RGW-	TVS09RK-	TVS09RKN-	TVS09RS-	TVS09RL-
CTVS56RF-	CTV56RW-	CTV56RGF-	CTV56RGW-	TVS56RK-	TVS56RKN-	TVS56RS-	TVS56RL-
-	-	-	-	MTVS26RK-	-	-	-

				TVPS00RK-	TVPS00RKN-	TVPS00RS-	TVPS00RL-
				TVPS02RK-	TVPS02RKN-	TVPS02RS-	TVPS02RL-
				TVS07RK-	TVS07RKN-	TVS07RS-	TVS07RL-
				TVPS40RK-	TVPS40RKN-	TVPS40RS-	TVPS40RL-
				TVS47RK-	TVS47RKN-	TVS47RS-	TVS47RL-
				TVPS10RK-	TVPS10RKN-	TVPS10RS-	TVPS10RL-
				TVPS12RK-	TVPS12RKN-	TVPS12RS-	TVPS12RL-

Hermetic only available in Stainless Steel	-	TVPS02Y-	-	TVPS02YN-
	-	TVS07Y-	-	TVS07YN-
	-	TVSIY-	-	TVSIYN-
	-	TVSHIY-	-	TVSHIYN-

1. Type & Class	2. Shell Size-Insert Arrg.	3. Contact Type	4. Alternate Position	5. PCB Length**	** If Required
	11-4	P			

## 2. SELECT A SHELL SIZE & INSERT ARRANGEMENT SEE PAGES 2-5

Shell Size & Insert Arrangements are on pages 2-5. First number represents Shell Size, second number is the Insert Arrangement.

\* Size 7 and 7H are Double Start Threads only

## 3. CONTACT TYPE

<b>P</b>	500 Cycle Pin Contacts, if require Less Contacts place (LC) at the end of part number
<b>S</b>	500 Cycle Socket Contacts, if require Less Contacts place (LC) at the end of part number
<b>H</b>	1500 Cycle Pin Contacts
<b>J</b>	1500 Cycle Socket Contacts
<b>X</b>	Eyelet contacts, hermetics only

# MIL-DTL-38999, Series III TV

## How to Order (Alternate Keying) Commercial

38999

### 4. SELECT A ALTERNATE KEYING COMMERCIAL

1.	2.	3.	4.	5.
Type & Class	Shell Size- Insert Arrg.	Contact Type	Alternate Position	PCB Length**
			N	

Shell Size	Key & Keyway Arrangement Identification Letter	AR° or AP° BSC	BR° or BP° BSC	CR° or CP° BSC	DR° or DP° BSC
7, 7H	N*	120	240		
	A	132	248		
	B	80	230	NA	NA
	C	140	275		
	D	155	234		
9	N*	105	140	215	265
	A	102	132	248	320
	B	80	118	230	312
	C	35	140	205	275
	D	64	155	234	304
11, 13, and 15	N*	95	141	208	236
	A	113	156	182	292
	B	90	145	195	252
	C	53	156	220	255
	D	119	146	176	298
17 and 19	N*	80	142	196	293
	A	135	170	200	310
	B	49	169	200	244
	C	66	140	200	257
	D	62	145	180	280
21, 23, and 25	N*	80	142	196	293
	A	135	170	200	310
	B	49	169	200	244
	C	66	140	200	257
	D	62	145	180	280
25L, 33, and 37	N*	80	142	188	293
	A	135	170	188	310
	B	49	169	188	244
	C	66	140	188	257
	D	62	145	188	280

\* An "N" designation is used on D38999 military part number but not on the commercial versions

### KEY/KEYWAY POSITION

A plug with a given rotation letter will mate with a receptacle with the same rotation letter. The angles for a given connector are the same whether it contains pins or sockets. Master key stays fixed, minor keys rotate. Inserts are not rotated in conjunction with the master key/keyway.

### RECEPTACLE (FRONT FACE SHOWN)



### PLUG (FRONT FACE SHOWN)



### Alignment Disc



Shell Size	D Dia. ±.010
9	.234
11	.350
13	.500
15	.725
17	.750
19	.850
21	.953
23	1.147
25	1.250

### 5. PCB LENGTH FOR COMMERCIAL ONLY

Contact Stickout	Pin Contacts	Pin Contacts with Alignment Disk	** If Required
.150"	(P15)	(P15AD)	
.250"	(P25)	(P25AD)	
.350"	(P35)	(P35AD)	

Contact Stickout	Socket Contacts	Socket Contacts with Alignment Disk
.150"	(S15)	(S15AD)
.250"	(S25)	(S25AD)
.350"	(S35)	(S35AD)

### 5. PCB LENGTH FOR HD38999 ONLY

9-9, 11-19, 13-32, 15-55, 17-73, 19-88, 21-121, 23-151, 25-187

PCB tail stickout +/- .040 inch	Without Alignment Disk		With Alignment Disk	
	Pins	Sockets	Pins	Sockets
.100" nominal	(P1*)	(S1)	(P1AD)	(S1AD)
.150" nominal	(P15*)	(S15)	(P15AD)	(S15AD)
.200" nominal	(P2)	(S2)	(P2AD)	(S2AD)
.250" nominal	(P25*)	(S25)	(P25AD)	(S25AD)
.300" nominal	(P3*)	(S3)	(P3AD)	(S3AD)
.350" nominal	(P35)	(S35)	(P35AD)	(S35AD)

\* Not available in TV40 wall mount double flange receptacle or TV47 jam nut double flange receptacle styles.

Note: Standard tail diameter is 0.019±.001 Stick out is measured from the end of the connector shell to end of the contact

Series III

### HOW TO ORDER - BOEING BACC63 CT & CU

1.	2.	3.	4.	5.	6.	7.	8.
Boeing Basic Number	Style	Shell Size	Shell Finish & Contact	Insert Arrangement	Contact Type	Alternate Keying Position	Ordering Option
BACC63	CT	15	–	19	P	N	H

### COMPOSITE

**1. BOEING NUMBER**

<b>BACC63</b>	Boeing
---------------	--------

**2. STYLE**

<b>CT</b>	Composite Plug
<b>CU</b>	Composite Receptacle

**3. SHELL SIZE**

<b>15</b>	One Shell Size
-----------	----------------

**4. SHELL FINISH & CONTACT**

<b>C</b>	CT Style Only. Cadmium Plated, Grounded
<b>D</b>	Cadmium Plated, ungrounded
<b>G</b>	Nickel Plated, Grounded
<b>–</b>	Nickel Plated, Ungrounded

**5. INSERT ARRANGEMENTS-**  
Consult Amphenol Aerospace for insert arrangements available.

**6. CONTACT TYPE**

<b>P</b>	Pin
<b>S</b>	Socket

**7. ALTERNATE KEYING POSITION**

<b>N</b>	Normal
<b>A-E</b>	Alternates

**8. ORDERING OPTIONS**

<b>H</b>	Without Contacts & Seal Plugs
<b>Blank</b>	With Contacts & Seal Plugs

### HOW TO ORDER - BOEING BACC63 DB & DC

1.	2.	3.	4.	5.	6.
Boeing Basic Number	Style	Shell Size-Insert Arrangement	Contact Type	Alternate Keying Position	Ordering Option
BACC63	DB	15-19	P	N	H
BACC63	DC	17-8	P	N	H

### STAINLESS STEEL

**1. BOEING NUMBER**

<b>BACC63</b>	Boeing
---------------	--------

**2. SELECT A STYLE**

<b>DB</b>	Stainless Steel Plug
<b>DC</b>	Stainless Steel Receptacle

**4. CONTACT TYPE**

<b>P</b>	Pin
<b>S</b>	Socket

**5. ALTERNATE KEYING POSITION**

<b>N</b>	Normal
<b>A-E</b>	Alternates

**6. ORDERING OPTION**

<b>H</b>	Without Contacts & Seal Plugs
<b>Blank</b>	With Contacts & Seal Plugs

**3. SELECT A SHELL SIZE & INSERT ARRANGEMENT  
SEE PAGES 2-5**

Shell Size & Insert Arrangements are on pages 2-5. First number represents Shell Size, second number is the Insert Arrangement. Please include the dash.

# Wall Mounting Receptacle

Military (D38999/20), Commercial (TVP00, TVPS00, CTVP00, CTVPS00)

38999

PART NUMBER BUILDER Page 42-46  
ONLINE CONFIGURATOR [www.amphenol-aerospace.com](http://www.amphenol-aerospace.com)

MILITARY  
D38999/20

Commercial

ALUMINUM  
TVPS00RF  
TVP00RW  
TVP00DT  
TVP00DZ  
TVP00RGF  
TVP00RGW  
TVPS00RB

COMPOSITE  
CTVPS00RF  
CTVP00RW  
CTVP00RGF  
CTVP00RGW

STAINLESS STEEL  
TVPS00RK  
TVPS00RKN  
TVPS00RS  
TVPS00RL



VIEW D  
FOR SIZE 8 COAXIAL ONLY,  
RELATIVE TO -A-



PANEL HOLE  
DIMENSIONS



BACK PANEL  
MOUNTING



FRONT PANEL  
MOUNTING

VIEW D  
FOR SIZE 8 TWINAX ONLY,  
RELATIVE TO -A-



† Red band indicates fully mated  
†† Blue band indicates rear release contact retention system

Inches

Shell Size	MS Shell Size Code	B Thread Class 2A 0.1P=0.3L-TS (Plated)	L Max. (TV)	L' Max. (CTV)	M +.000 -.005 (TV)	M' +.000 -.005 (CTV)	R <sup>1</sup>	R <sup>2</sup>	S Max.	T ±.008	Z Max. (TV)	Z' Max. (CTV)	A <sup>1</sup> Back Panel Mount	A <sup>2</sup> Front Panel Mount	AA Max. Panel Thickness	LL +.006 -.000 (TV)	LL1 ±.005 (CTV)	TT ±.008
9	A	.6250	.469	.514	.820	.773	.719	.594	.948	.128	.153	.198	.655	.516	.234	.905	.908	.216
11	B	.7500	.469	.514	.820	.773	.812	.719	1.043	.128	.153	.198	.796	.625	.234	.905	.908	.194
13	C	.8750	.469	.514	.820	.773	.906	.812	1.137	.128	.153	.198	.922	.750	.234	.905	.908	.194
15	D	1.0000	.469	.514	.820	.773	.969	.906	1.232	.128	.153	.198	1.047	.906	.234	.905	.908	.173
17	E	1.1875	.469	.514	.820	.773	1.062	.969	1.323	.128	.153	.198	1.219	1.016	.234	.905	.908	.194
19	F	1.2500	.469	.514	.820	.773	1.156	1.062	1.449	.128	.153	.198	1.297	1.141	.234	.905	.908	.194
21	G	1.3750	.500	.545	.790	.741	1.250	1.156	1.575	.128	.183	.228	1.442	1.266	.204	.905	.904	.194
23	H	1.5000	.500	.545	.790	.741	1.375	1.250	1.701	.154	.183	.228	1.547	1.375	.204	.905	.904	.242
25	J	1.6250	.500	.545	.790	.741	1.500	1.375	1.823	.154	.183	.228	1.672	1.484	.204	.905	.904	.242

Millimeters

Shell Size	MS Shell Size Code	L Max. (TV)	L' Max. (CTV)	M +.00 -.13 (TV)	M' +.00 -.13 (CTV)	R <sup>1</sup>	R <sup>2</sup>	S Max.	T ±.20	V Thread Metric	Z Max. (TV)	Z' Max. (CTV)	A <sup>1</sup> Back Panel Mount	A <sup>2</sup> Front Panel Mount	AA Max.	LL +.15 -.00 (TV)	LL1 ±.13 (CTV)	TT ±.20
9	A	11.91	13.06	20.83	19.63	18.26	15.09	24.1	3.25	M12X1-6g	3.89	5.03	16.66	13.11	5.94	22.99	23.06	5.49
11	B	11.91	13.06	20.83	19.63	20.62	18.26	26.5	3.25	M15X1-6g	3.89	5.03	20.22	15.88	5.94	22.99	23.06	4.93
13	C	11.91	13.06	20.83	19.63	23.01	20.62	28.9	3.25	M18X1-6g	3.89	5.03	23.42	19.05	5.94	22.99	23.06	4.93
15	D	11.91	13.06	20.83	19.63	24.61	23.01	31.3	3.25	M22X1-6g	3.89	5.03	26.59	23.01	5.94	22.99	23.06	4.39
17	E	11.91	13.06	20.83	19.63	26.97	24.61	33.7	3.25	M25X1-6g	3.89	5.03	30.96	25.81	5.94	22.99	23.06	4.93
19	F	11.91	13.06	20.83	19.63	29.36	26.97	36.9	3.25	M28X1-6g	3.89	5.03	32.94	28.98	5.94	22.99	23.06	4.93
21	G	12.70	13.84	20.07	18.82	31.75	29.36	40.1	3.25	M31X1-6g	4.65	5.79	36.12	32.16	5.18	22.99	22.96	4.93
23	H	12.70	13.84	20.07	18.82	34.93	31.75	43.3	3.91	M34X1-6g	4.65	5.79	39.29	34.93	5.18	22.99	22.96	6.15
25	J	12.70	13.84	20.07	18.82	38.10	34.93	46.4	3.91	M37X1-6g	4.65	5.79	42.47	37.69	5.18	22.99	22.96	6.15

All dimensions for reference only  Designates true position dimensioning



# Box Mounting Receptacle

## Commercial (TVP02, TVPS02, CTVP02, CTVPS02)

PART NUMBER BUILDER Page 44-46  
ONLINE CONFIGURATOR [www.amphenol-aerospace.com](http://www.amphenol-aerospace.com)

<b>Commercial</b>	<b>ALUMINUM</b>	<b>COMPOSITE</b>	<b>STAINLESS STEEL</b>
	TVPS02RF	CTVPS02RF	TVPS02RK
	TVP02RW	CTVP02RW	TVPS02RKN
	TVP02DT	CTVP02RGF	TVPS02RS
	TVP02DZ	CTVP02RGW	TVPS02RL
	TVP02RGF		
	TVP02RGW		



38999

III
II
I
SJT
Access
Aquacon



### PANEL HOLE DIMENSIONS



### BACK PANEL MOUNTING



### FRONT PANEL MOUNTING

† Red band indicates fully mated  
†† Blue band indicates rear release contact retention system

Consult Amphenol Aerospace for availability of composite box mount receptacles.

Inches

Shell Size	MS Shell Size Code	B Thread Class 2A 0.1P=0.3L-TS (Plated)	L Max. (TV)	L1 Max. (CTV)	M +.000 - .005 (TV)	M1 +.000 - .005 (CTV)	R1	R2	S Max.	T ±.008	Z Max. (TV)	Z1 Max. (CTV)	A1 Back Panel Mount	A2 Front Panel Mount	AA Max. Panel Thickness	LL +.006 - .000 (TV)	LL1 ±.005 (CTV)	TT ±.008
9	A	.6250	.205	.250	.820	.773	.719	.594	.948	.128	.153	.198	.650	.510	.234	.905	.908	.216
11	B	.7500	.205	.250	.820	.773	.812	.719	1.043	.128	.153	.198	.800	.620	.234	.905	.908	.194
13	C	.8750	.205	.250	.820	.773	.906	.812	1.137	.128	.153	.198	.910	.740	.234	.905	.908	.194
15	D	1.0000	.205	.250	.820	.773	.969	.906	1.232	.128	.153	.198	1.040	.900	.234	.905	.908	.173
17	E	1.1875	.205	.250	.820	.773	1.062	.969	1.323	.128	.153	.198	1.210	1.010	.234	.905	.908	.194
19	F	1.2500	.205	.250	.820	.773	1.156	1.062	1.449	.128	.153	.198	1.280	1.130	.234	.905	.908	.194
21	G	1.3750	.235	.280	.790	.741	1.250	1.156	1.575	.128	.183	.228	1.410	1.250	.204	.905	.904	.194
23	H	1.5000	.235	.280	.790	.741	1.375	1.250	1.701	.154	.183	.228	1.530	1.360	.204	.905	.904	.242
25	J	1.6250	.235	.280	.790	.741	1.500	1.375	1.823	.154	.183	.228	1.660	1.470	.204	.905	.904	.242

Millimeters

Shell Size	MS Shell Size Code	L Max. (TV)	L1 Max. (CTV)	M +.00 - .13 (TV)	M' +.00 - .13 (CTV)	R1	R2	S Max.	T ±.20	Z Max. (TV)	Z' Max. (CTV)	A1 Back Panel Mount	A2 Front Panel Mount	AA Max.	LL +.15 - .00 (TV)	LL1 ±.13 (CTV)	TT ±.20
9	A	5.21	6.35	20.83	19.63	18.26	15.09	24.1	3.25	3.89	5.03	16.66	13.11	5.94	22.99	23.06	5.49
11	B	5.21	6.35	20.83	19.63	20.62	18.26	26.5	3.25	3.89	5.03	20.22	15.88	5.94	22.99	23.06	4.93
13	C	5.21	6.35	20.83	19.63	23.01	20.62	28.9	3.25	3.89	5.03	23.42	19.05	5.94	22.99	23.06	4.93
15	D	5.21	6.35	20.83	19.63	24.61	23.01	31.3	3.25	3.89	5.03	26.59	23.01	5.94	22.99	23.06	4.39
17	E	5.21	6.35	20.83	19.63	26.97	24.61	33.7	3.25	3.89	5.03	30.96	25.81	5.94	22.99	23.06	4.93
19	F	5.21	6.35	20.83	19.63	29.36	26.97	36.9	3.25	3.89	5.03	32.94	28.98	5.94	22.99	23.06	4.93
21	G	5.97	7.11	20.07	18.82	31.75	29.36	40.1	3.25	4.65	5.79	36.12	32.16	5.18	22.99	22.96	4.93
23	H	5.97	7.11	20.07	18.82	34.92	31.75	43.3	3.91	4.65	5.79	39.29	34.93	5.18	22.99	22.96	6.15
25	J	5.97	7.11	20.07	18.82	38.10	34.92	46.4	3.91	4.65	5.79	42.47	37.69	5.18	22.99	22.96	6.15

All dimensions for reference only

Designates true position dimensioning

# Line Receptacle

## Commercial (TV01, TVS01, CTV01, CTVS01)

PART NUMBER BUILDER Page 44-46  
 ONLINE CONFIGURATOR [www.amphenol-aerospace.com](http://www.amphenol-aerospace.com)



Commercial	ALUMINUM	COMPOSITE	STAINLESS STEEL
	TVS01RF	CTVS01RF	TVS01RK
	TV01RW	CTV01RW	TVS01RKN
	TV01DT	CTV01RGF	TVS01RS
	TV01DZ	CTV01RGW	TVS01RL
	TV01RGF		
	TV01RGW		
	TVS01RB		



† Red band indicates fully mated  
 †† Blue band indicates rear release contact retention system

VIEW D  
 FOR SIZE 8 COAXIAL ONLY,  
 RELATIVE TO -A-



VIEW D  
 FOR SIZE 8 TWINAX ONLY,  
 RELATIVE TO -A-



Inches

Shell Size	MS Shell Size Code	B Thread 0.1P-0.3L-TS-2A (Plated)	M +.000 -0.005 (TV)	M' +.000 -0.005 (CTV)	L Max. (TV)	L' Max. (CTV)	S ±.010 (TV)	S' ±.010 (CTV)	Z Max (TV)	Z' Max (CTV)	GG ±.010 (TV)	GG' ±.010 (CTV)	LL +.006 -0.000 (TV)	LL' ±.005 (CTV)
9	A	.6250	.820	.773	.469	.514	.675	.635	.153	.198	.812	.699	.905	.908
11	B	.7500	.820	.773	.469	.514	.800	.765	.153	.198	.905	.875	.905	.908
13	C	.8750	.820	.773	.469	.514	.925	.885	.153	.198	1.093	1.007	.905	.908
15	D	1.0000	.820	.773	.469	.514	1.050	1.100	.153	.198	1.219	1.140	.905	.908
17	E	1.1875	.820	.773	.469	.514	1.238	1.197	.153	.198	1.375	1.229	.905	.908
19	F	1.2500	.820	.773	.469	.514	1.300	1.260	.153	.198	1.469	1.380	.905	.908
21	G	1.3750	.790	.741	.500	.545	1.425	1.385	.183	.228	1.625	1.493	.905	.904
23	H	1.5000	.790	.741	.500	.545	1.550	1.510	.183	.228	1.750	1.626	.905	.904
25	J	1.6250	.790	.741	.500	.545	1.675	1.635	.183	.228	1.875	1.777	.905	.904

Millimeters

Shell Size	MS Shell Size Code	M +.00 -0.13 (TV)	M1 +.00 -0.13 (CTV)	L Max. (TV)	L1 Max. (CTV)	S ±.25 (TV)	S1 ±.010 (CTV)	V Thread Metric	Z Max (TV)	Z1 Max (CTV)	GG ±.25 (TV)	GG1 ±.25 (CTV)	LL +.15 -0.00 (TV)	LL1 ±.13 (CTV)
9	A	20.83	19.63	11.91	13.06	17.15	16.13	M12X1-6g	3.89	5.03	20.62	17.75	22.99	23.06
11	B	20.83	19.63	11.91	13.06	20.32	19.43	M15X1-6g	3.89	5.03	22.99	22.22	22.99	23.06
13	C	20.83	19.63	11.91	13.06	23.50	22.47	M18X1-6g	3.89	5.03	27.76	25.57	22.99	23.06
15	D	20.83	19.63	11.91	13.06	26.67	27.94	M22X1-6g	3.89	5.03	30.96	28.95	22.99	23.06
17	E	20.83	19.63	11.91	13.06	31.45	30.40	M25X1-6g	3.89	5.03	34.93	31.21	22.99	23.06
19	F	20.83	19.63	11.91	13.06	33.02	32.00	M28X1-6g	3.89	5.03	37.31	35.05	22.99	23.06
21	G	20.07	18.82	12.70	13.84	36.20	35.18	M31X1-6g	4.65	5.79	41.28	37.92	22.99	22.96
23	H	20.07	18.82	12.70	13.84	39.37	38.35	M34X1-6g	4.65	5.79	44.45	41.30	22.99	22.96
25	J	20.07	18.82	12.70	13.84	42.55	41.53	M37X1-6g	4.65	5.79	47.63	45.13	22.99	22.96

All dimensions for reference only

# Jam Nut Receptacle

## Military (D38999/24), Commercial (TV07, TVS07, CTV07, CTVP07)

PART NUMBER BUILDER Page 42-46

ONLINE CONFIGURATOR [www.amphenol-aerospace.com](http://www.amphenol-aerospace.com)

**MILITARY**  
D38999/24

**Commercial**

**ALUMINUM**  
TVS07RF  
TV07RW  
TV07DT  
TV07DZ  
TV07RGF  
TV07RGW  
TVS07RB

**COMPOSITE**  
CTVPS07RF  
CTV07RW  
CTV07RGF  
CTV07RGW

**STAINLESS STEEL**  
TVS07RK  
TVS07RKN  
TVS07RS  
TVS07RL



38999

- III
- II
- I
- SJT
- Access
- Aquacon

**Series III**



- † Red band indicates fully mated
- †† Blue band indicates rear release contact retention system
- ★ .059 dia min.
- 1.5 dia min., 3 lockwire holes Formed lockwire hole design (6 holes) is optional

Inches

Shell Size	MS Shell Size Code	B Thread Class 2A 0.1P-0.3L-TS (Plated)	C Max.	D <sup>1</sup> +.010 -0.000	D <sup>2</sup> +.000 -0.010	H Hex +.017 -0.016	S ±.010
9	A	.6250	1.199	.693	.657	.875	1.062
11	B	.7500	1.386	.825	.770	1.000	1.250
13	C	.8750	1.511	1.010	.955	1.188	1.375
15	D	1.0000	1.636	1.135	1.085	1.312	1.500
17	E	1.1875	1.761	1.260	1.210	1.438	1.625
19	F	1.2500	1.949	1.385	1.335	1.562	1.812
21	G	1.3750	2.073	1.510	1.460	1.688	1.938
23	H	1.5000	2.199	1.635	1.585	1.812	2.062
25	J	1.6250	2.323	1.760	1.710	2.000	2.188

Millimeters

Shell Size	MS Shell Size Code	C Max.	D <sup>1</sup> +.25 -0.00	D <sup>2</sup> +.00 -0.25	H Hex +.43 -0.41	S ±.25	V Thread Metric
9	A	30.45	17.60	16.70	22.23	26.97	M12X1-6g
11	B	35.20	20.96	19.59	25.40	31.75	M15X1-6g
13	C	38.38	25.65	24.26	30.18	34.93	M18X1-6g
15	D	41.55	28.83	27.56	33.32	38.10	M22X1-6g
17	E	44.73	32.01	30.73	36.53	41.28	M25X1-6g
19	F	49.50	35.18	33.91	39.67	46.02	M28X1-6g
21	G	52.65	38.35	37.08	42.80	49.23	M31X1-6g
23	H	55.85	41.53	40.26	46.02	52.37	M34X1-6g
25	J	59.00	44.70	43.43	50.80	55.58	M37X1-6g

All dimensions for reference only NOTE: Deep reach receptacles are available for panel thicknesses up to .750 max.

# Straight Plug

## Military (D38999/26), Commercial (TV06, TVS06, CTV06, CTVS06)

38999

PART NUMBER BUILDER Page 42-46  
 ONLINE CONFIGURATOR [www.amphenol-aerospace.com](http://www.amphenol-aerospace.com)

**MILITARY**  
 D38999/26

Commercial

**ALUMINUM**  
 TVS06RF  
 TV06RW  
 TV06DT  
 TV06DZ  
 TV06RGF  
 TV06RGW  
 TVS06RB

**COMPOSITE**  
 CTVS06RF  
 CTV06RW  
 CTV06RGF  
 CTV06RGW

**STAINLESS STEEL**  
 TVS06RK  
 TVS06RKN  
 TVS06RS  
 TVS06RL



VIEW D  
 FOR SIZE 8 COAXIAL ONLY,  
 RELATIVE TO -A-



COMPOSITE



VIEW D  
 FOR SIZE 8 TWINAX ONLY,  
 RELATIVE TO -A-



† Blue band indicates rear release contact retention system

Inches

Shell Size	MS Shell Size Code	B Thread 0.1P-0.3L-TS-2B (Plated)	Q Dia. Max.
9	A	.6250	.858
11	B	.7500	.984
13	C	.8750	1.157
15	D	1.0000	1.280
17	E	1.1875	1.406
19	F	1.2500	1.516
21	G	1.3750	1.642
23	H	1.5000	1.768
25	J	1.6250	1.890

All dimensions for reference only.

Millimeters

Shell Size	MS Shell Size Code	Q Max.	V Thread Metric
9	A	21.8	M12X1-6g
11	B	25.0	M15X1-6g
13	C	29.4	M18X1-6g
15	D	32.5	M22X1-6g
17	E	35.7	M25X1-6g
19	F	38.5	M28X1-6g
21	G	41.7	M31X1-6g
23	H	44.9	M34X1-6g
25	J	48.0	M37X1-6g

Series III

A

# Flange Mounting Plug

## Commercial (TV09, TVS09, CTV09, CTVPS09)

PART NUMBER BUILDER Page 44-46  
ONLINE CONFIGURATOR [www.amphenol-aerospace.com](http://www.amphenol-aerospace.com)

<b>Commercial</b>	<b>ALUMINUM</b>	<b>COMPOSITE</b>	<b>STAINLESS STEEL</b>
	TVS09RF	CTVPS09RF	TVS09RK
	TV09RW	CTV09RW	TVS09RKN
	TV09DT	CTV09RGF	TVS09RS
	TV09DZ	CTV09RGW	TVS09RL
	TV09RGF		
	TV09RGW		
	TVS09RB		



38999

III
II
I
SJT
Access
Aquacon

**Series III**



Shell Size	MS Shell Size Coded	B Thread 0.1P-0.3L-TS-2A (Plated)	G ±.060	Q Dia. Max	R	GG Dia ±.005
9**	A	.6250	1.106	.859	1.038	1.838
11	B	.7500	1.106	.969	1.115	1.948
13**	C	.8750	1.106	1.141	1.240	2.124
15	D	1.0000	1.106	1.266	1.327	2.248
17	E	1.1875	1.106	1.391	1.417	2.375
19	F	1.2500	1.356	1.500	1.557	2.495
21	G	1.3750	1.356	1.625	1.624	2.568
23	H	1.5000	1.356	1.750	1.713	2.723
25	J	1.6250	1.356	1.875	1.801	2.848

Millimeters

Shell Size	MS Shell Size Coded	G ±.152	Q Dia. Max	R	GG Dia ±.13
9**	A	28.09	21.82	26.37	46.69
11	B	28.09	24.62	28.32	49.48
13**	C	28.09	28.98	31.50	53.95
15	D	28.09	32.16	33.71	57.10
17	E	28.09	35.33	35.99	60.33
19	F	34.44	38.10	39.55	63.37
21	G	34.44	41.28	41.25	65.23
23	H	34.44	44.45	43.51	69.16
25	J	34.44	47.63	45.75	72.34

All dimensions for reference only

☐ Designates true position dimensioning

\*\* Partially tooled. Consult Amphenol Aerospace for availability

# High Vibration Dualok Connector 38999 Series III Type

## Commercial Plug (TV56, TVS56, CTV56, CTVS56)

38999

PART NUMBER BUILDER Page 44-46  
 ONLINE CONFIGURATOR [www.amphenol-aerospace.com](http://www.amphenol-aerospace.com)

Commercial	ALUMINUM	COMPOSITE	STAINLESS STEEL
	TVS56RF	CTVS56RF	TVS56RK
	TV56RW	CTV56RW	TVS56RKN
	TV56DT	CTV56RGF	TVS56RS
	TV56DZ	CTV56RGW	TVS56RL
	TV56RGF		
	TV56RGW		
	TVS56RB		

Dualok



Shell Size	B Thread 0.1-0.3L-TS-2B (Plated)	E Dia. Max.	Q Dia. Max. Metric	V Thread Metric.
9	.6250	.953	24.2	M12X1-6g
11	.7500	1.053	26.7	M15X1-6g
13	.8750	1.252	31.8	M18X1-6g
15	1.0000	1.365	34.6	M22X1-6g
19	1.2500	1.605	40.7	M28X1-6g
21	1.3750	1.735	44.0	M31X1-6g
25	1.6250	1.975	50.1	M37X1-6g

A

# Clutch-Lok™ Plug

## Commercial (26)

Designed for high vibration and harsh environments such as aircraft gas turbine engines, the CLUTCH-LOK is also an ideal choice for demanding applications such as aircraft, space and military ground vehicles. The unique clutch design of the Amphenol CLUTCH-LOK means that you don't have to compromise the need for quick, smooth mating of plugs and receptacles in order to get increased uncoupling torque.

The CLUTCH-LOK has proven to not only remain mated and pass all the Series III specification requirements, it also has proven to actually tighten itself under vibration. This is a powerful advantage over the traditionally high vibration application connectors. The CLUTCH-LOK is also a tremendous advantage in inaccessible, hard to reach areas where mating torque is difficult to apply and complete coupling is not verifiable by inspection.

### CLUTCH-LOK FEATURES AND BENEFITS:

- High degree of differential torque
- Infinite free coupling and positive metal-to-metal bottoming with each mating
- No settling back to the next ratchet tooth
- Available with stainless steel shells and Class K firewall inserts
- All the advantages of MIL-DTL-38999 Series III including EMI/RFI shielding, electrolytic erosion resistance and contact protection with recessed pins
- Enhanced connector performance at affordable prices
- Completely intermateable with all existing MIL-DTL-38999 Series III connectors
- Fully QPL'd

PART NUMBER BUILDER Page 44-46  
ONLINE CONFIGURATOR [www.amphenol-aerospace.com](http://www.amphenol-aerospace.com)

### STAINLESS STEEL MTV26RK



Inches

Shell Size	MS Shell Size Code	B Thread 0.1P-0.3L-TS-2B (Plated)	Q Dia. Max.
9	A	.6250	.858
11	B	.7500	.984
13	C	.8750	1.157
15	D	1.0000	1.280
17	E	1.1875	1.406
19	F	1.2500	1.516
21	G	1.3750	1.642
23	H	1.5000	1.768
25	J	1.6250	1.890

Millimeters

Shell Size	MS Shell Size Code	Q Max.	V Thread Metric
9	A	21.8	M12X1-6g
11	B	25.0	M15X1-6g
13	C	29.4	M18X1-6g
15	D	32.5	M22X1-6g
17	E	35.7	M25X1-6g
19	F	38.5	M28X1-6g
21	G	41.7	M31X1-6g
23	H	44.9	M34X1-6g
25	J	48.0	M37X1-6g

All dimensions for reference only.

# PCB Wall Mounting Receptacle (Back Panel Mounting)

## Commercial (TVP00 & TVPS00)

38999

PART NUMBER BUILDER Page 44-46  
 ONLINE CONFIGURATOR [www.amphenol-aerospace.com](http://www.amphenol-aerospace.com)

Commercial	ALUMINUM	STAINLESS STEEL
	TVPS00RF	TVPS00RK
	TVP00RW	TVPS00RKN
	TVP00DT	TVPS00RS
	TVP00DZ	TVPS00RL
	TVPS00RB	



Shell Size	B Thread Class 2A (Plated) 0.1P-0.3L-TS	L Max. (TV)	L' Max. (CTV)	M +.000 - .005 (TV)	M' +.000 - .005 (CTV)	R1	R2	S Max.	T +.008 - .006	V Thread Metric	AA Max. Panel Thickness	LL +.006 - .000 (TV)	LL' ±.005 (CTV)	TT +.008 - .006
9	.6250	.469	.514	.820	.773	.719	.594	.948	.128	M12X1-6g	.234	.905	.908	.216
11	.7500	.469	.514	.820	.773	.812	.719	1.043	.128	M15X1-6g	.234	.905	.908	.194
13	.8750	.469	.514	.820	.773	.906	.812	1.137	.128	M18X1-6g	.234	.905	.908	.194
15	1.0000	.469	.514	.820	.773	.969	.906	1.232	.128	M22X1-6g	.234	.905	.908	.173
17	1.1875	.469	.514	.820	.773	1.062	.969	1.323	.128	M25X1-6g	.234	.905	.908	.194
19	1.2500	.469	.514	.820	.773	1.156	1.062	1.449	.128	M28X1-6g	.234	.905	.908	.194
21	1.3750	.500	.545	.790	.741	1.250	1.156	1.575	.128	M31X1-6g	.204	.905	.904	.194
23	1.5000	.500	.545	.790	.741	1.375	1.250	1.701	.154	M34X1-6g	.204	.905	.904	.242
25	1.6250	.500	.545	.790	.741	1.500	1.375	1.823	.154	M37X1-6g	.204	.905	.904	.242

All dimensions for reference only.

Most common options are shown; other options are available.

Designates true position dimensioning

A



# PCB Wall Mounting Receptacle (Back Panel Mounting) (With Clinch Nuts)

## Commercial (TVP10 & TVPS10)

PART NUMBER BUILDER Page 44-46  
ONLINE CONFIGURATOR [www.amphenol-aerospace.com](http://www.amphenol-aerospace.com)

<b>Commercial</b>	<b>ALUMINUM</b>	<b>STAINLESS STEEL</b>
	TVPS10RF	TVPS10RK
	TVP10RW	TVPS10RKN
	TVP10DT	TVPS10RS
	TVP10DZ	TVPS10RL
	TVPS10RB	

III
II
I
SJT
Access
Aquacon

**Series III**



Shell Size	B Thread Class 2A (Plated) 0.1P-0.3L-TS	L Max. (TV)	L' Max. (CTV)	M +.000 - .005 (TV)	M' +.000 - .005 (CTV)	R	S Max.	T Thread	V Thread Metric	AA Max. Panel Thickness	LL +.006 - .000 (TV)	LL' ±.005 (CTV)
9	.6250	.469	.514	.820	.773	.719	1.094	.112-40UNC-3B	M12X1-6g	.234	.905	.908
11	.7500	.469	.514	.820	.773	.812	1.187	.112-40UNC-3B	M15X1-6g	.234	.905	.908
13	.8750	.469	.514	.820	.773	.906	1.281	.112-40UNC-3B	M18X1-6g	.234	.905	.908
15	1.0000	.469	.514	.820	.773	.969	1.344	.112-40UNC-3B	M22X1-6g	.234	.905	.908
17	1.1875	.469	.514	.820	.773	1.062	1.437	.112-40UNC-3B	M25X1-6g	.234	.905	.908
19	1.2500	.469	.514	.820	.773	1.156	1.531	.112-40UNC-3B	M28X1-6g	.234	.905	.908
21	1.3750	.500	.545	.790	.741	1.250	1.625	.112-40UNC-3B	M31X1-6g	.204	.905	.904
23	1.5000	.500	.545	.790	.741	1.375	1.750	.138-32UNC-3B	M34X1-6g	.204	.905	.904
25	1.6250	.500	.545	.790	.741	1.500	1.875	.138-32UNC-3B	M37X1-6g	.204	.905	.904

All dimensions for reference only.

Consult Amphenol for more information on ordering connectors with clinch nuts.  
Most common options are shown; other options are available.

□ Designates true position dimensioning

† Red band indicates fully mated

†† Blue band indicates rear release contact retention system

# PCB Wall Mounting Double Flange Receptacle

## Commercial (TVP40 & TVPS40)

38999

PART NUMBER BUILDER Page 44-46

ONLINE CONFIGURATOR [www.amphenol-aerospace.com](http://www.amphenol-aerospace.com)

Commercial

ALUMINUM  
 TVPS40RF  
 TVP40RW  
 TVP40DT  
 TVP40DZ  
 TVPS40RB

STAINLESS STEEL  
 TVPS40RK  
 TVPS40RKN  
 TVPS40RS  
 TVPS40RL

Series III



(4) CORROSION RESISTANT STEEL  
 SELF-LOCKING CLINCH NUTS  
 .112-40 UNC-3B PER MIL-N-45938/6-4C  
 EXCEPT FOR TV40 SHELL SIZES 23 & 25:  
 .138-32 UNC-3B PER MIL-N-45938/6-6C

(4) CORROSION RESISTANT STEEL  
 .112-40 UNC-3B HELICAL INSERTS

$\text{⊕} \text{⊖} \text{⌀} .005 \text{Ⓜ}$

$\text{⊕} \text{⊖} \text{⌀} .005 \text{Ⓜ}$

Shell Size	MS Shell Size Code (For Ref.)	A Dia. ±.005 (TV)	A Dia. ±.005 (CTV)	B Thread Class 2A (Plated) 0.1P-0.3L-TS	M +.000 - .005	M' ±.003 (CTV)	R (Panel Mount) (CTV)	R (Panel Mount) (TV)	S Max. (TV)	S Max. (CTV)	AA Max. Panel Thickness	PCB Mounting Dimensions	
												T Dia. (TV) TP	W (CTV) TP
9	A	NA	1.016	.6250	.820	.770	.719	N/A	NA	.949	.234	NA	.532
11	B	1.062	1.148	.7500	.820	.770	.812	.766	1.187	1.042	.234	.850	.601
13	C	1.250	1.250	.8750	.820	.770	.906	.859	1.281	1.136	.234	.994	.703
15	D	1.375	1.375	1.0000	.820	.770	.969	.938	1.344	1.230	.234	1.119	.791
17	E	1.500	1.500	1.1875	.820	.770	1.062	1.016	1.437	1.323	.234	1.237	.875
19	F	1.625	1.625	1.2500	.820	.770	1.156	1.110	1.531	1.449	.234	1.379	.975
21	G	1.750	1.750	1.3750	.820	.738	1.250	1.206	1.625	1.573	.204	1.489	1.053
23	H	1.875	1.875	1.5000	.820	.738	1.375	1.312	1.750	1.699	.204	1.619	1.195
25	J	2.000	2.000	1.6250	.820	.738	1.500	1.438	1.875	1.823	.204	1.744	1.233

All dimensions for reference only.

† Red band indicates fully mated

†† Blue band indicates rear release contact retention system

A

# PCB Box Mounting Receptacle

## Commercial (TVP02 & TVPS02)

PART NUMBER BUILDER Page 44-46  
ONLINE CONFIGURATOR [www.amphenol-aerospace.com](http://www.amphenol-aerospace.com)

Commercial	ALUMINUM	STAINLESS STEEL
	TVPS02RF	TVPS02RK
	TVP02RW	TVPS02RKN
	TVP02DT	TVPS02RS
	TVP02DZ	TVPS02RL
	TVPS02RB	

38999

- III
- II
- I
- SJT
- Access
- Aquacon

Series III

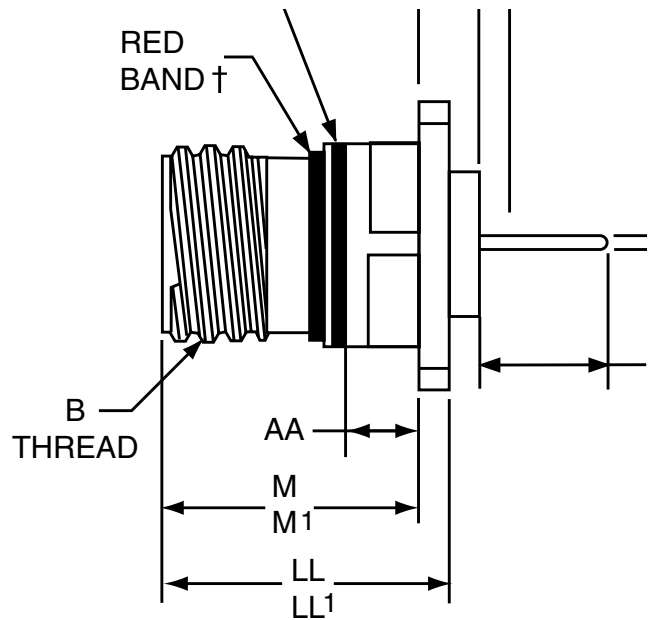

Shell Size	B Thread Class 2A (Plated) 0.1P-0.3L-TS	L Max. (TV)	L' Max. (CTV)	M +.000 -0.005 (TV)	M' +.000 -0.005 (CTV)	R1	R2	S Max.	T +.008 -0.006	AA Max. Panel Thickness	LL +.006 -0.000 (TV)	LL' ±.005 (CTV)	TT ±.008
9	.6250	.205	.250	.820	.773	.719	.594	.948	.128	.234	.905	.908	.216
11	.7500	.205	.250	.820	.773	.812	.719	1.043	.128	.234	.905	.908	.194
13	.8750	.205	.250	.820	.773	.906	.812	1.137	.128	.234	.905	.908	.194
15	1.0000	.205	.250	.820	.773	.969	.906	1.232	.128	.234	.905	.908	.173
17	1.1875	.205	.250	.820	.773	1.062	.969	1.323	.128	.234	.905	.908	.194
19	1.2500	.205	.250	.820	.773	1.156	1.062	1.449	.128	.234	.905	.908	.194
21	1.3750	.235	.280	.790	.741	1.250	1.156	1.575	.128	.204	.905	.904	.194
23	1.5000	.235	.280	.790	.741	1.375	1.250	1.701	.154	.204	.905	.904	.242
25	1.6250	.235	.280	.790	.741	1.500	1.375	1.823	.154	.204	.905	.904	.242

All dimensions for reference only.  
Most common options are shown; other options are available.

- Designates true position dimensioning
- † Red band indicates fully mated
- †† Blue band indicates rear release contact retention system

# PCB Box Mounting Receptacle (With Clinch Nuts)

## Commercial (TVP12 & TVPS12)

38999

PART NUMBER BUILDER Page 44-46

ONLINE CONFIGURATOR [www.amphenol-aerospace.com](http://www.amphenol-aerospace.com)

Commercial

ALUMINUM  
**TVPS12RF**  
**TVP12RW**  
**TVP12DT**  
**TVP12DZ**  
**TVPS12RB**

STAINLESS STEEL  
**TVPS12RK**  
**TVPS12RKN**  
**TVPS12RS**  
**TVPS12RL**

Series III



Shell Size	B Thread Class 2A (Plated) 0.1P-0.3L-TS	L Max. (TV)	L' Max. (CTV)	M +.000 - .005 (TV)	M' +.000 - .005 (CTV)	R	S Max.	T Thread	AA Max. Panel Thickness	LL +.006 - .000 (TV)	LL' +.006 - .000 (CTV)
9	.6250	.205	.250	.820	.773	.719	1.031	.112-40UNC-3B	.234	.905	.908
11	.7500	.205	.250	.820	.773	.812	1.125	.112-40UNC-3B	.234	.905	.908
13	.8750	.205	.250	.820	.773	.906	1.172	.112-40UNC-3B	.234	.905	.908
15	1.0000	.205	.250	.820	.773	.969	1.281	.112-40UNC-3B	.234	.905	.908
17	1.1875	.205	.250	.820	.773	1.062	1.375	.112-40UNC-3B	.234	.905	.908
19	1.2500	.205	.250	.820	.773	1.156	1.469	.112-40UNC-3B	.234	.905	.908
21	1.3750	.235	.280	.790	.741	1.250	1.562	.112-40UNC-3B	.204	.905	.904
23	1.5000	.235	.280	.790	.741	1.375	1.750	.112-40UNC-3B	.204	.905	.904
25	1.6250	.235	.280	.790	.741	1.500	1.875	.112-40UNC-3B	.204	.905	.904

All dimensions for reference only.  
 Most common options are shown; other options are available.

□ Designates true position dimensioning  
 † Red band indicates fully mated  
 †† Blue band indicates rear release contact retention system

A

# PCB Jam Nut Receptacle

## Commercial (TV07 & TVS07)

PART NUMBER BUILDER Page 44-46  
ONLINE CONFIGURATOR [www.amphenol-aerospace.com](http://www.amphenol-aerospace.com)

Commercial

ALUMINUM	STAINLESS STEEL
TVS07RF	TVS07RK
TV07RW	TVS07RKN
TV07DT	TVS07RS
TV07DZ	TVS07RL
TVS07RB	

38999

III
II
I
SJT
Access
Aquacon

Series III



Shell Size	A* +.000 -.010	B Thread Class 2A (Plated) 0.1P-0.3L-TS	C Max.	D1 +.010 -.000	D2 +.010 -.000	H Hex +.017 -.016	S ±.010	T +.010 -.000	V Thread Metric
9	.669	.6250	1.199	.700	.670	.875	1.062	.697	M12X1-6g
11	.769	.7500	1.386	.825	.770	1.000	1.250	.822	M15X1-6g
13	.955	.8750	1.511	1.010	.955	1.188	1.375	1.007	M18X1-6g
15	1.084	1.0000	1.636	1.135	1.085	1.312	1.500	1.134	M22X1-6g
17	1.208	1.1875	1.761	1.260	1.210	1.438	1.625	1.259	M25X1-6g
19	1.333	1.2500	1.949	1.385	1.335	1.562	1.812	1.384	M28X1-6g
21	1.459	1.3750	2.073	1.510	1.460	1.688	1.938	1.507	M31X1-6g
23	1.575	1.5000	2.199	1.635	1.585	1.812	2.062	1.634	M34X1-6g
25	1.709	1.6250	2.323	1.760	1.710	2.000	2.188	1.759	M37X1-6g

All dimensions for reference only.  
Most common options are shown;  
other options are available.

- † Red band indicates fully mated
- †† Blue band indicates rear release contact retention system
- \* .059 dia. min. 3 lockwire holes. Formed lockwire hole design (6 holes) is optional. \*\*"D" shaped mounting hole dimensions

# PCB Jam Nut, Double Flange Receptacles

## Commercial (TVP47 & TVPS47)

38999

PART NUMBER BUILDER Page 44-46

ONLINE CONFIGURATOR [www.amphenol-aerospace.com](http://www.amphenol-aerospace.com)

Commercial

ALUMINUM  
 TVPS47RF  
 TVP47RW  
 TVP47DT  
 TVP47DZ

STAINLESS STEEL  
 TVPS47RK  
 TVPS47RKN  
 TVPS47RS  
 TVPS47RL

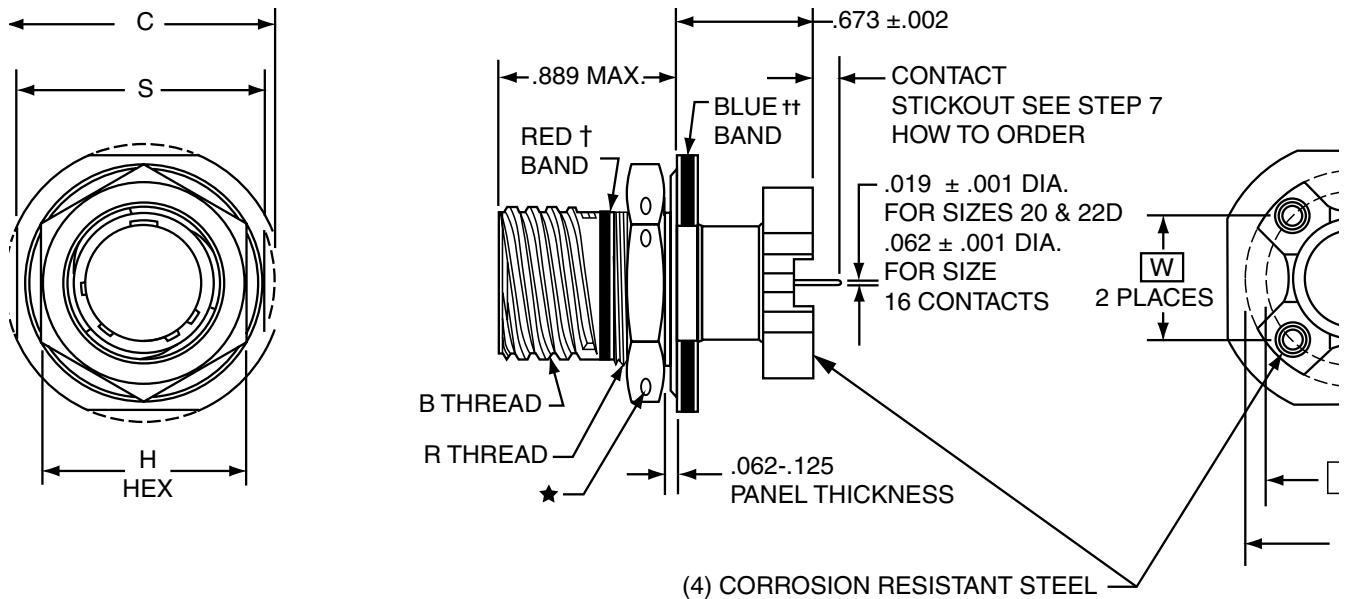
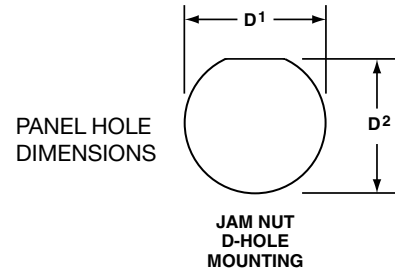

Shell Size	MS Shell Size Code (For Ref.)	B Thread Class 2A 0.1P-0.3L-TS (Plated)	C ±.005 (Jam Nut Flange Dia.)	D1 +.010 - .000	D2 +.000 - .010	H Hex +.017 - .016	M Dia. ±.005 (TV)	M Dia. ±.005 (CTV)	R Thread Metric (Plated)	S +.011 - .010	PCB Mounting Dimensions	
											V Dia. (TV) TP	W (CTV) TP
9	A	.6250	1.188	.700	.670	.875	1.062	1.016	M17X1-6g0.100R	1.062	.753	.532
11	B	.7500	1.375	.825	.770	1.000	1.062	1.148	M20X1-6g0.100R	1.250	.850	.601
13	C	.8750	1.500	1.010	.955	1.188	1.250	1.250	M25X1-6g0.100R	1.375	.994	.703
15	D	1.0000	1.625	1.135	1.085	1.312	1.375	1.375	M28X1-6g0.100R	1.500	1.119	.791
17	E	1.1875	1.750	1.260	1.210	1.438	1.500	1.500	M32X1-6g0.100R	1.625	1.237	.875
19	F	1.2500	1.937	1.385	1.335	1.562	1.625	1.625	M35X1-6g0.100R	1.812	1.379	.975
21	G	1.3750	2.062	1.510	1.460	1.688	1.750	1.750	M38X1-6g0.100R	1.937	1.489	1.053
23	H	1.5000	2.188	1.635	1.585	1.812	1.875	1.875	M41X1-6g0.100R	2.062	1.644	1.145
25	J	1.6250	2.312	1.760	1.710	2.000	2.000	2.000	M44X1-6g0.100R	2.188	1.744	1.233

All dimensions for reference only.

† Red band indicates fully mated

†† Blue band indicates rear release contact retention system.

★ .059 dia. min. (1.5 dia. min.) 3 lockwire holes.

Formed lockwire hole design (6 holes) is optional.

A

# PCB Hermetic Box Mounting Receptacle

## Commercial

38999



	1.	2.	3.	4.	5.	6.
<b>PART #</b>	Base Number	Coded Shell Size	Insert Arrg.	Contact Type/Alt. Keying	Shell Finish	Tail Length
See chart below	10-626	501	-35	P	1	B

## HOW TO ORDER

### 1. BASE NUMBER:

<b>10-626</b>	Base Number for MIL-DTL-38999 Series III Hermetic with PCB Tail
---------------	---

### 2. SELECT A CODED SHELL SIZE:

See chart below **501-509**, designates size 9-25 shell size.  
Example: **501** = Size 9 Shell

### 3. SELECT AN INSERT ARRANGEMENT:

Refer to insert availability chart on page 2-5 and pin-out illustrations on pages 14-28. Please enter the second number which represents the Insert Arrangement number.

<b>-35</b>	Designates Insert Arrangement Number
------------	--------------------------------------

### 4. CONTACT TYPE/ALTERNATE KEYING POSITIONS:

Refer to page 46 for alternate rotation letters to use.

<b>P</b>	Designates Pin Contacts in Normal Position
<b>S</b>	Designates Socket Contacts in Normal Position

### 5. SELECT A SHELL FINISH:

<b>1</b>	Hermetic seal, passivated Stainless Steel, 200°C
<b>2</b>	Hermetic seal, Stainless Steel w/Nickel Plate
<b>3</b>	Carbon Steel w/reflowed tin plate

### 6. SELECT A TAIL LENGTH:

<b>B</b>	.100±.03
<b>D</b>	.200±.03
<b>F</b>	.300±.03

Shell Size	Part Number	B Thread 0.1P-0.3L-TS (Plated)	R1	R2	S ±.010	T ±.008	TT ±.008
9	10-626 <b>501</b> -XXX	.6250	.719	.594	.938	.128	.216
11	<b>502</b> -XXX	.7500	.812	.719	1.031	.128	.194
13	<b>503</b> -XXX	.8750	.906	.812	1.125	.128	.194
15	<b>504</b> -XXX	1.0000	.969	.906	1.219	.128	.173
17	<b>505</b> -XXX	1.1875	1.062	.969	1.312	.128	.194
19	<b>506</b> -XXX	1.2500	1.156	1.062	1.438	.128	.194
21	<b>507</b> -XXX	1.3750	1.250	1.156	1.562	.128	.194
23	<b>508</b> -XXX	1.5000	1.375	1.250	1.688	.154	.242
25	<b>509</b> -XXX	1.6250	1.500	1.375	1.812	.154	.242

† Red band indicates fully mated

NOTE: Consult Amphenol Aerospace for availability of non-glass-sealed versions with printed circuit tail contacts.

All dimensions for reference.

Designates true position dimensioning

III

II

I

SJT

Access

Aquacon

Series III

A

# PCB Hermetic Jam Nut Receptacle

## Commercial

38999

III  
II  
I  
SJT  
Access  
Aquacon

Series III



	1.	2.	3.	4.	5.	6.
<b>PART #</b>	Base Number	Coded Shell Size	Insert Arrg.	Contact Type/Alt. Keying	Shell Finish	Tail Length
See chart below	10-626	471	-35	P	I	B

## HOW TO ORDER

### 1. BASE NUMBER:

**10-626** Base Number for MIL-DTL-38999 Series III Hermetic with PCB Tail

### 2. SELECT A CODED SHELL SIZE:

See chart below **471-479**, designates size 9-25 shell size.

### 3. SELECT AN INSERT ARRANGEMENT:

Refer to insert availability chart on page 2-5 and pin-out illustrations on pages 14-28. Please enter the second number which represents the Insert Arrangement number.

**-35** Designates Insert Arrangement Number

### 4. CONTACT TYPE/ALTERNATE KEYING POSITIONS:

Refer to page 46 for alternate rotation letters to use.

<b>P</b>	Designates Pin Contacts in Normal Position
<b>S</b>	Designates Socket Contacts in Normal Position

### 5. SELECT A SHELL FINISH:

<b>1</b>	Hermetic seal, passivated Stainless Steel, 200°C
<b>2</b>	Hermetic seal, Stainless Steel w/Nickel Plate
<b>3</b>	Carbon Steel w/reflowed tin plate

### 6. SELECT A TAIL LENGTH:

<b>B</b>	100 ±.03
<b>D</b>	.200 ±.03
<b>F</b>	.300 ±.03

† Red band indicates fully mated

★ .059 dia. min. (1.5 dia. min.) 3 lockwire holes. Formed lockwire hole design (6 holes) is optional.

Shell Size	Part Number	A+ +.000 -.010	B Thread Class 2A 0.1P-0.3L- TS (Plated)	C Max	D1 +.010 -.000	D1 +.000 -.010	H Hex +.017 -.016	L Max	S ±.010	T+ +.010 -.000	KK +.011 -.000
9	<b>10-626471-XXX</b>	.669	.6250	1.199	.700	.670	.875	.357	1.062	.697	.642
11	<b>472-XXX</b>	.769	.7500	1.386	.825	.770	1.000	.357	1.250	.822	.766
13	<b>473-XXX</b>	.955	.8750	1.511	1.010	.955	1.188	.357	1.375	1.007	.892
15	<b>474-XXX</b>	1.084	1.0000	1.636	1.135	1.085	1.312	.357	1.500	1.134	1.018
17	<b>475-XXX</b>	1.208	1.1875	1.761	1.260	1.210	1.438	.357	1.625	1.259	1.142
19	<b>476-XXX</b>	1.333	1.2500	1.949	1.385	1.335	1.562	.381	1.182	1.384	1.268
21	<b>477-XXX</b>	1.459	1.3750	2.073	1.510	1.460	1.688	.381	1.938	1.507	1.392
23	<b>478-XXX</b>	1.575	1.5000	2.199	1.635	1.585	1.812	.381	2.062	1.634	1.518
25	<b>479-XXX</b>	1.709	1.6250	2.323	1.760	1.710	2.000	.381	2.188	1.759	1.642

All dimensions for reference only.

A



# PCB Hermetic Solder Mounting Receptacle

## Commercial



	1.	2.	3.	4.	5.	6.
<b>PART #</b> See chart below	Base Number 10-626	Coded Shell Size 481	Insert Arrg. -35	Contact Type/Alt. Keying P	Shell Finish 1	Tail Length B

## HOW TO ORDER

### 1. BASE NUMBER:

<b>10-626</b>	Base Number for MIL-DTL-38999 Series III Hermetic with PCB Tail
---------------	---

### 2. SELECT A CODED SHELL SIZE:

See chart below 481-489, designates size 9-25 shell size.

### 3. SELECT AN INSERT ARRANGEMENT:

Refer to insert availability chart on page 2-5 and pin-out illustrations on pages 14-28. Please enter the second number which represents the Insert Arrangement number.

<b>-35</b>	Designates Insert Arrangement Number
------------	--------------------------------------

### 4. CONTACT TYPE/ALTERNATE KEYING POSITIONS:

Refer to page 46 for alternate rotation letters to use.

<b>P</b>	Designates Pin Contacts in Normal Position
<b>S</b>	Designates Socket Contacts in Normal Position

### 5. SELECT A SHELL FINISH:

<b>1</b>	Hermetic seal, passivated Stainless Steel, 200°C
<b>2</b>	*Hermetic seal, Stainless Steel w/Nickel Plate
<b>3</b>	*Carbon Steel w/reflowed tin plate

### 6. SELECT A TAIL LENGTH:

<b>B</b>	.100±.03
<b>D</b>	.200±.03
<b>F</b>	.300±.03

† Red band indicates fully mated

Shell Size	Part Number	B Thread Class 2A 0.1P-0.3L- TS (Plated)	L +.011 -.005	M +.006 -.005	GG Dia. +.011 -.010	KK Dia +.011 -.005
9	<b>10-626481-XXX</b>	.6250	.806	.125	.750	.672
11	<b>482-XXX</b>	.7500	.806	.125	.844	.781
13	<b>483-XXX</b>	.8750	.806	.125	.969	.906
15	<b>484-XXX</b>	1.0000	.806	.125	1.094	1.031
17	<b>485-XXX</b>	1.1875	.806	.125	1.218	1.156
19	<b>486-XXX</b>	1.2500	.806	.125	1.312	1.250
21	<b>487-XXX</b>	1.3750	.806	.125	1.438	1.375
23	<b>488-XXX</b>	1.5000	.838	.156	1.563	1.500
25	<b>489-XXX</b>	1.6250	.838	.156	1.688	1.625

# PCB Hermetic Weld Mounting Receptacle

## Commercial

38999

III  
II  
I  
SJT  
Access  
Aquacon

Series III



	1.	2.	3.	4.	5.	6.
<b>PART #</b>	Base Number	Coded Shell Size	Insert Arrg.	Contact Type/Alt. Keying	Shell Finish	Tail Length
See chart below	10-626	49†	-35	P	1	B

## HOW TO ORDER

### 1. BASE NUMBER:

**10-626** Base Number for MIL-DTL-38999 Series III Hermetic with PCB Tail

### 2. SELECT A CODED SHELL SIZE:

See chart below **491-499**, designates size 9-25 shell size.

### 3. SELECT AN INSERT ARRANGEMENT:

Refer to insert availability chart on page 2-5 and pin-out illustrations on pages 14-28. Please enter the second number which represents the Insert Arrangement number.

**-35** Designates Insert Arrangement Number

### 4. CONTACT TYPE/ALTERNATE KEYING POSITIONS:

Refer to page 46 for alternate rotation letters to use.

**P** Designates Pin Contacts in Normal Position  
**S** Designates Socket Contacts in Normal Position

### 5. SELECT A SHELL FINISH:

**1** Hermetic seal, passivated Stainless Steel, 200°C  
**2** \*Hermetic seal, Stainless Steel w/Nickel Plate  
**3** \*Carbon Steel w/reflowed tin plate

### 6. SELECT A TAIL LENGTH:

**B** .100±.03  
**D** .200±.03  
**F** .300±.03

Shell Size	Part Number	B Thread Class 2A 0.1P-0.3L-TS (Plated)	L +.011 -.000	M +.006 -.005	GG Dia. +.011 -.010
9	<b>10-626491-XXX</b>	.6250	.806	.125	.973
11	<b>492-XXX</b>	.7500	.806	.125	1.095
13	<b>493-XXX</b>	.8750	.806	.125	1.221
15	<b>494-XXX</b>	1.0000	.806	.125	1.347
17	<b>495-XXX</b>	1.1875	.806	.125	1.434
19	<b>496-XXX</b>	1.2500	.806	.125	1.579
21	<b>497-XXX</b>	1.3750	.806	.125	1.721
23	<b>498-XXX</b>	1.5000	.838	.156	1.886
25	<b>499-XXX</b>	1.6250	.838	.156	1.973

\* Not available for weld mount. All dimensions for reference only.

A

# Hermetic Box Mounting Receptacle

## Military (D38999/21), Commercial (TVPS02)

PART NUMBER BUILDER Page 42-46  
ONLINE CONFIGURATOR [www.amphenol-aerospace.com](http://www.amphenol-aerospace.com)

**MILITARY**  
**D38999/21**

Commercial

**STAINLESS STEEL**  
**TVPS02Y**  
**TVPS02YN**



† Red band indicates fully mated

NOTE: Consult Amphenol Aerospace for availability of non-glass-sealed versions with printed circuit tail contacts.

Inches

Shell Size	MS Shell Size Coded	B Thread 0.1P-0.3L-TS (Plated)	R1	R2	S ±.010	T ±.008	TT ±.008
9	A	.6250	.719	.594	.938	.128	.216
11	B	.7500	.812	.719	1.031	.128	.194
13	C	.8750	.906	.812	1.125	.128	.194
15	D	1.0000	.969	.906	1.219	.128	.173
17	E	1.1875	1.062	.969	1.312	.128	.194
19	F	1.2500	1.156	1.062	1.438	.128	.194
21	G	1.3750	1.250	1.156	1.562	.128	.194
23	H	1.5000	1.375	1.250	1.688	.154	.242
25	J	1.6250	1.500	1.375	1.812	.154	.242

Millimeters

Shell Size	MS Shell Size Coded	R1	R2	S ±.25	T ±.20	TT ±.20
9	A	18.26	15.09	23.83	3.25	5.49
11	B	20.62	18.26	26.19	3.25	4.93
13	C	23.01	20.62	28.58	3.25	4.93
15	D	24.61	23.01	30.96	3.25	4.39
17	E	26.97	24.61	33.32	3.25	4.93
19	F	29.36	26.97	36.53	3.25	4.93
21	G	31.75	29.36	39.67	3.25	4.93
23	H	34.93	31.75	42.88	3.91	6.15
25	J	38.10	34.93	46.02	3.91	6.15

All dimensions for reference only

  Designates true position dimensioning

38999

- III
- II
- I
- SJT
- Access
- Aquacon

Series III

A

# Hermetic Jam Nut Receptacle

## Military (D38999/23), Commercial (TVS07)

38999

PART NUMBER BUILDER Page 42-46  
 ONLINE CONFIGURATOR [www.amphenol-aerospace.com](http://www.amphenol-aerospace.com)

**MILITARY**  
**D38999/23**

**Commercial**

**STAINLESS STEEL**  
**TVS07Y**  
**TVS07YN**



† Red band indicates fully mated

★ .059 dia min.

1.5 dia min. 3 lockwire holes Formed lockwire hole design (6 holes) is optional.

Inches

Shell Size	MS Shell Size code	B Thread Class 2A 0.1P-0.3L-TS (Plated)	C Max	D <sup>1</sup> +.010 -0.000	D <sup>2</sup> +.000 -0.010	H Hex +.017 -0.016	L Max	S ±.010	KK +.011 -0.000
9	A	.6250	1.199	.693	.657	.875	.357	1.062	.642
11	B	.7500	1.386	.825	.770	1.000	.357	1.250	.766
13	C	.8750	1.511	1.010	.955	1.188	.357	1.375	.892
15	D	1.0000	1.636	1.135	1.085	1.312	.357	1.500	1.018
17	E	1.1875	1.761	1.260	1.210	1.438	.357	1.625	1.142
19	F	1.2500	1.949	1.385	1.335	1.562	.381	1.812	1.268
21	G	1.3750	2.073	1.510	1.460	1.688	.381	1.938	1.392
23	H	1.5000	2.199	1.635	1.585	1.812	.381	2.062	1.518
25	J	1.6250	2.323	1.760	1.710	2.000	.381	2.188	1.642

Millimeters

Shell Size	MS Shell Size code	C Max	D <sup>1</sup> +.25 -0.00	D <sup>2</sup> +.00 -0.25	H Hex +.43 -0.41	L Max	S ±.25	KK +.28 -0.00
9	A	30.45	17.60	16.70	22.23	9.07	26.97	16.31
11	B	35.20	20.96	19.59	25.40	9.07	31.75	19.46
13	C	38.38	25.65	24.26	30.18	9.07	34.93	22.66
15	D	41.55	28.83	27.56	33.32	9.07	38.10	25.86
17	E	44.73	32.01	30.73	36.53	9.07	41.28	29.01
19	F	49.50	35.18	33.91	39.67	9.68	46.02	32.21
21	G	52.65	38.35	37.08	42.80	9.68	49.23	35.36
23	H	55.85	41.53	40.26	46.02	9.68	52.37	38.56
25	J	59.00	44.70	43.43	50.80	9.68	55.58	41.71

All dimensions for reference only

A

# Hermetic Solder Mounting Receptacle

## Military (D38999/25), Commercial (TVSI)

PART NUMBER BUILDER Page 42-46  
ONLINE CONFIGURATOR [www.amphenol-aerospace.com](http://www.amphenol-aerospace.com)

**MILITARY**  
**D38999/25**

**Commercial**  
STAINLESS STEEL  
TVSIY  
TVSIYN



† Red band indicates fully mated Inches

Shell Size	MS Shell Size Code	B Thread Class 2A 0.1P-0.3L-TS (Plated)	L +.011 - .005	M +.006 - .005	GG Dia. +.011 - .010	KK Dia +.011 - .005
9	A	.6250	.806	.125	.750	.672
11	B	.7500	.806	.125	.844	.781
13	C	.8750	.806	.125	.969	.906
15	D	1.0000	.806	.125	1.094	1.031
17	E	1.1875	.806	.125	1.218	1.156
19	F	1.2500	.806	.125	1.312	1.250
21	G	1.3750	.806	.125	1.438	1.375
23	H	1.5000	.838	.156	1.563	1.500
25	J	1.6250	.838	.156	1.688	1.625

Millimeters

Shell Size	MS Shell Size Code	L +.28 - .00	M +.15 - .13	GG Dia. +.28 - .25	KK Dia +.03 - .13
9	A	20.47	3.18	19.05	17.07
11	B	20.47	3.18	21.44	19.84
13	C	20.47	3.18	24.61	23.01
15	D	20.47	3.18	27.79	26.19
17	E	20.47	3.18	30.94	29.36
19	F	20.47	3.18	33.32	31.75
21	G	20.47	3.18	36.53	34.93
23	H	21.29	3.96	39.70	38.10
25	J	21.29	3.96	42.88	41.28

# Hermetic Wall Mounting Receptacle

## Military (D38999/27), Commercial (TVSHIY)

PART NUMBER BUILDER Page 42-46  
ONLINE CONFIGURATOR  
[www.amphenol-aerospace.com](http://www.amphenol-aerospace.com)

**MILITARY**  
**D38999/27**

**Commercial**  
STAINLESS STEEL  
TVSHIY  
TVSHIYN

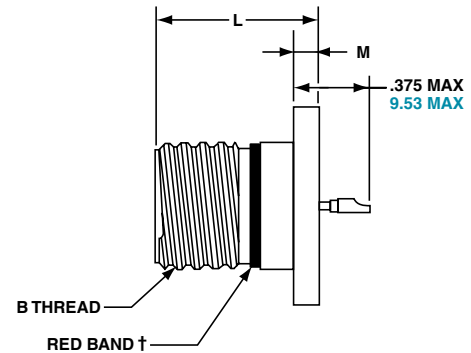

† Red band indicates fully mated Inches

Shell Size	MS Shell Size Code	B Thread Class 2A 0.1P-0.3L-TS (Plated)	L +.011 - .005	M +.006 - .005	GG Dia. +.011 - .010
9	A	.6250	.806	.125	.973
11	B	.7500	.806	.125	1.095
13	C	.8750	.806	.125	1.221
15	D	1.0000	.806	.125	1.347
17	E	1.1875	.806	.125	1.434
19	F	1.2500	.806	.125	1.579
21	G	1.3750	.806	.125	1.721
23	H	1.5000	.838	.156	1.886
25	J	1.6250	.838	.156	1.973

Millimeters

Shell Size	MS Shell Size Code	L +.28 - .00	M +.15 - .13	GG Dia. +.25 - .00
9	A	20.47	3.18	24.71
11	B	20.47	3.18	27.81
13	C	20.47	3.18	31.01
15	D	20.47	3.18	34.21
17	E	20.47	3.18	36.42
19	F	20.47	3.18	40.11
21	G	20.47	3.18	43.71
23	H	21.29	3.96	47.90
25	J	21.29	3.96	50.11

All dimensions for reference only

# Series III, TV Breakaway Fail-Safe Connectors

## Quick-Disconnect with an Axial Pull of Lanyard

38999

Amphenol® Tri-Start Breakaway Fail-Safe Connectors provide unequalled performance in environments requiring instant disengagement.

The “Breakaway” Fail-Safe connector family offers a wide range of electrical and mechanical features:

- Instant decoupling and damage free separation
- Completely intermateable with standard receptacles (D38999/20 and /24)
- Inventory support commonality through the use of standard insert arrangements and contacts

Breakaway unmating is initiated by applying a pull force to the lanyard which causes the operating sleeve on the plug to move away from the receptacle. Coupling segments on the plug then move away from the mating receptacle while expanding, thus releasing the receptacle. After completion of the unmating sequence, spring compression returns the sleeve and segments to their original positions. Unmating of the plug may also be accomplished by normal rotation of the coupling ring without affecting the breakaway capability.

The Tri-Start Breakaway Fail-Safe connector exceeds the MIL-Spec Series III requirements for EMI/EMP shielding and features include:

- Solid metal-to-metal coupling
- EMI grounding fingers
- Conductive finishes

Amphenol Breakaway Fail-Safe connectors are qualified to MIL-DTL-38999/29, /30 and /31 (for MIL-STD-1760 Stores Management applications). Amphenol also manufactures custom breakaway connectors including those with:

- Highly durable non-metallic operating sleeves in a variety of lengths and diameters
- Increased pull-force capability
- Low-profile designs
- Custom lanyard lengths and backshells
- Low force separation capabilities
- Low insertion/separation force contacts
- Non-cadmium finishes

Contact your local Amphenol representative. Whether you need a standard Breakaway, one of our custom Breakaways, or a unique Breakaway design.



TYPE 2

TYPE 6

TYPE 1

Amphenol offers a variety of lanyard plug styles including MIL-STD-1760 types 1, 2 and 6 for Stores Management applications.



Breakaway with Coax Contacts



Special configuration Fail-Safe used on space telescope application. Lanyard is replaced by a swivel ring for remote disconnect and “wing arms” have been added for manual actuation accessibility by gloved astronauts.

# TV Breakaway Fail-Safe Lanyard Release Plug

## Military (D38999/29 & D38999/30)

### HOW TO ORDER - MILITARY

1.	2.	3.	4.	5.	6.	7.
DOD Number Prefix	Spec Sheet Number	Service Class	Shell Size	Insert Arrangement	Lanyard Length Code	Alternate Keying Position
D38999/	29	F	E	35	P	N

#### 1. DOD NUMBER PREFIX

**D38999/** Designates MIL-DTL-38999, Series III, Tri-Start Connector

#### 2. SPECIFICATION SHEET NUMBER

**29** Lanyard Release Plug with pin contacts

**30** Lanyard Release Plug with socket contacts

#### 3. SERVICE CLASS

**F** Designates electroless nickel plated aluminum, optimum EMI shielding effectiveness -65dB@10 GHz specification min., 48 hour salt spray, 200°C

**W** Designates corrosion resistant olive drab cadmium plate aluminum, 500 hour extended salt spray, EMI -50dB@10 GHz specification min., 175°C

#### 4. & 5. INSERT AVAILABILITY

Shell Size- Insert Arrangement	Military Shell Size- Insert Arrangement	Commercial Basic Part# Shell & Insert Arrg. Code	Service Rating	Total Contacts	Contact Size							
					22D	20	16	12	12 Coax	8 Coax	8 Twinax	
11-2	N/A	88/91-556508	I	2			2					
11-35	N/A	06	M	13	13							
11-98	N/A	07	I	6		6						
13-4	N/A	10	I	4			4					
13-8	N/A	11	I	8		8						
13-35	N/A	14	M	22	22							
13-98	N/A	13	I	10		10						
15-5	N/A	18	II	5			5					
15-15	N/A	23	I	15		14	1					
15-18	N/A	22	I	18		18						
15-19	N/A	19	I	19		19						
15-35	N/A	20	M	37	37							
15-97	N/A	21	I	12		8	4					
17-6	E-6	27	I	6				6				
17-8	E-8	28	II	8			8					
17-26	E-26	29	I	26		26						
17-35	E-35	30	M	55	55							
17-99	E-99	31	I	23		21	2					
19-11	F-11	37	II	11			11					
19-32	F-32	39	I	32		32						
19-35	F-35	40	M	66	66							
21-11	G-11	47	I	11				11				
21-16	G-16	48	II	16			16					
21-35	G-35	49	M	79	79							
21-39	G-39	51	I	39		37	2					
21-41	G-41	50	I	41		41						
23-21	H-21	57	II	21			21					
23-35	H-35	58	M	100	100							
23-53	H-53	59	I	53		53						
23-54	H-54	61	M	53	40		9	4				
23-55	H-55	60	I	55		55						
25-4	J-4	71	I	56		48	8					
25-19	J-19	66	I	19				19				
25-20	J-20	74	N	30		10	13		4			3
25-24	J-24	72	I	24			12	12				
25-29	J-29	67	I	29			29					
25-35	J-35	68	M	128	128							
25-43	J-43	69	I	43		23	20					
25-46	J-46	73	I	46		40	4			2*		
25-61	J-61	70	I	61		61						

- III
- II
- I
- SJT
- Access
- Aquacon

Series III

A

# TV Breakaway Fail-Safe Lanyard Release Plug

## Military (D38999/29 & D38999/30)

38999

### 6. MILITARY LANYARD LENGTH CODE

Table II

Lanyard Length (in.) ± .236	Lanyard Length (mm) ± 6.0	Lanyard Length Code For Part Number
4.016	102	A
4.528	115	B
5.000	127	C
5.512	140	D
6.024	153	E
6.535	166	F
7.008	178	G
7.520	191	H
7.992	203	I
8.503	216	J
9.016	229	K
9.528	242	L
10.000	254	M
10.512	267	N
11.024	280	P
11.535	293	R
12.008	305	S
12.520	318	T
13.031	331	U
14.016	356	V
15.000	381	W
16.024	407	X
17.008	432	Y
18.031	458	Z

### 7. MILITARY ALTERNATE KEYING POSITION

For alternate positions of connector (to prevent cross-mating) (N indicates normal).

Shell Size	Key & Keyway Arrangement Identification Letter	AR° or AP° BSC	BR° or BP° BSC	CR° or CP° BSC	DR° or DP° BSC
7, 7H	N*	120	240	NA	NA
	A	132	248		
	B	80	230		
	C	140	275		
	D	155	234		
9	N*	105	140	215	265
	A	102	132	248	320
	B	80	118	230	312
	C	35	140	205	275
	D	64	155	234	304
11, 13, and 15	N*	95	141	208	236
	A	113	156	182	292
	B	90	145	195	252
	C	53	156	220	255
	D	119	146	176	298
17 and 19	N*	80	142	196	293
	A	135	170	200	310
	B	49	169	200	244
	C	66	140	200	257
	D	62	145	180	280
21, 23, and 25	N*	80	142	196	293
	A	135	170	200	310
	B	49	169	200	244
	C	66	140	200	257
	D	62	145	180	280
25L, 33, and 37	N*	80	142	188	293
	A	135	170	188	310
	B	49	169	188	244
	C	66	140	188	257
	D	62	145	188	280
	N*	80	153	188	272
	A	79	153	197	272
	B	79	153	197	272
	C	79	153	197	272
	D	79	153	197	272

RECEPTACLE (FRONT FACE SHOWN)



PLUG (FRONT FACE SHOWN)



Series III

A



# TV Breakaway Fail-Safe Lanyard Release Plug

## Commercial (88-5565 & 91-5565)

### HOW TO ORDER - COMMERCIAL

Ordering procedure for example part number 88-556529-EP is shown below:

1.	2.	3.	4.	5.	6.
Service Class	Connector Type Identification	Shell Size & Insert Arrg. Code	Required Field	Lanyard Length Code	Contact Type/Alternate Keying Position
88	-5565	29	0	E	P

#### 1. SERVICE CLASS

88	Designates corrosion resistant olive drab cadmium plate over nickel, 500 hour extended salt spray, EMI -50dB @ 10 GHz specification min., 175°C
91	Designates electroless nickel plated aluminum, optimum EMI shielding effectiveness -65dB @ 10 GHz specification min., 48 hour salt spray, 200°C

These are standard finishes. Consult Amphenol Aerospace for other variations.

#### 2. CONNECTOR TYPE IDENTIFICATION

-5565	Designates MIL-DTL-38999, Series III Tri-Start Lanyard Release Plug
-------	---

#### 3. SELECT A COMMERCIAL SHELL SIZE & INSERT ARRANGEMENT CODE

MIL-DTL-38999, see insert availability chart on page 71.

#### 4. REQUIRED FIELD

0	THE REQUIRED FIELD IS ALWAYS A 0
---	----------------------------------

#### 5. SELECT A LANYARD LENGTH CODE

Lanyard Length (in.) ± .236	Lanyard Length (mm) ± 6.0	Lanyard Length Code For Part Number
4.016	102	A
4.528	115	B
5.000	127	C
5.512	140	D
6.024	153	E
6.535	166	F
7.008	178	G
7.520	191	H
7.992	203	I
8.503	216	J
9.016	229	K
9.528	242	L
10.000	254	M
10.512	267	N
11.024	280	P
11.535	293	R
12.008	305	S
12.520	318	T
13.031	331	U
14.016	356	V
15.000	381	W
16.024	407	X
17.008	432	Y
18.031	458	Z

#### 6. SELECT A CONTACT TYPE/ALTERNATE KEYING POSITION

P designates pin, S designates socket for normal positioning of contacts. When an alternate position of the connector is required to prevent cross-mating, a different letter (other than P or S) is used. See alternate positioning on page 72, then convert to Amphenol Commercial coding by the following chart.

Pin Contacts		Socket Contacts	
MS Letter	Amphenol letter	MS Letter	Amphenol Letter
PN	<b>P (normal)</b>	SN	<b>S (normal)</b>
PA	<b>G</b>	SA	<b>H</b>
PB	<b>I</b>	SB	<b>J</b>
PC	<b>K</b>	SC	<b>L</b>
PD	<b>M</b>	SD	<b>N</b>
PE	<b>R</b>	SE	<b>T</b>

# Fail-Safe Lanyard Release Plug-Crimp, Metal

## Military (D38999/29 & D38999/30), Commercial (88-5565 & 91-5565)

38999

PART NUMBER BUILDER Page 71-73  
 ONLINE CONFIGURATOR [www.amphenol-aerospace.com](http://www.amphenol-aerospace.com)

**MILITARY**  
 D38999/29 Pin  
 D38999/30 Socket

**Commercial**  
 STAINLESS STEEL  
 88-5565  
 91-5565

### METAL

.374 MAX  
 9.50 MAX  
 OUTER SLEEVE MOVEMENT  
 DURING UNMATING THREAD RELEASE



† Blue band indicates rear release contact retention system

Inches

Shell Size	MS Shell Size Code	B Max	D Max Accessory Dia.
11	B	1.846	1.109
13	C	1.972	1.250
15	D	2.079	1.375
17	E	2.205	1.500
19	F	2.301	1.625
21	G	2.472	1.750
23	H	2.594	1.875
25	J	2.705	2.000

Millimeters

Shell Size	MS Shell Size Code	B Max	D Max Accessory Dia.	V Thread Metric
11	B	46.89	28.17	M15X1.0-6g
13	C	50.09	31.75	M18X1.0-6g
15	D	52.81	34.93	M22X1.0-6g
17	E	56.01	38.10	M25X1.0-6g
19	F	58.45	41.28	M28X1.0-6g
21	G	62.79	44.45	M31X1.0-6g
23	H	65.89	47.63	M34X1.0-6g
25	J	68.71	50.08	M37X1.0-6g

Series III

A

# TV Breakaway Fail-Safe Lanyard Release

## Military (D38999/31) Type 1 & 2 for MIL-STD-1760

Applications- Lanyard Release Plug

38999

III  
II  
I  
SJT  
Access  
Aquacon

Series III

### HOW TO ORDER - BY MILITARY PART NUMBER FAIL-SAFE D38999/31

Ordering procedure for example part number D38999/31WE20PN1 is shown below:

1.	2.	3.	4.	5.	6.	7.	8.
DOD Number Prefix	Spec Sheet Number	Service Class	Lanyard Length Code	Insert Arrangement	Contact Style	Alternate Keying Position	Type Number
D38999/	31	W	E	20	P	N	1

#### 1. DOD NUMBER PREFIX

D38999/	MIL-DTL-38999, Series III Tri-Start Connectors
---------	--

#### 2. SPECIFICATION SHEET NUMBER

31	Designates Lanyard Release Plug for MIL-STD-1760 with pin contacts
----	--

#### 3. SERVICE CLASS

F	Electroless nickel plated aluminum, optimum EMI shielding effectiveness -65dB @ 10 GHz specification min., 48 hour salt spray, 200°C
W	Corrosion resistant olive drab cadmium plate aluminum, 500 hour extended salt spray, EMI -50dB @ 10 GHz specification min., 175°C

#### 4. LANYARD LENGTH CODE

Lanyard Length (in.) ±.236	Lanyard Length (mm.) ± 6.0	Lanyard Length Code for Part Number
6.024	153.0	E
6.535	166.0	F
7.008	178.0	G
7.520	191.0	H
7.992	203.0	I
8.504	216.0	J
9.016	229.0	K
9.528	242.0	L

#### 5. INSERT ARRANGEMENT

11	25-11
20	25-20

#### 6. CONTACT STYLE-P & A ARE VALID OPTIONS

P	Replaces the "no designation" option in the PIN on revision C and earlier revision of the Mil-Spec.
A	Designates supplied less contacts.

#### 7. ALTERNATE KEYING POSITION

N	Is required for normal position.
---	----------------------------------

#### 8. TYPE NUMBER

TYPE 1, 2 OR 6. SEE DRAWINGS ON PAGE 76.

For accessories for lanyard release plugs see Accessories section.

**MILITARY**  
**D38999/31**

**TYPE 6**  
**88-555875/76**  
**91-555875/76**

**TYPE 2**  
**88-558518/19**  
**91-558518/19**

**TYPE 1-Longer Shell**  
**T3W-16B25-XXXX**

# TV Breakaway Fail-Safe Lanyard Release

## Military (D38999/31) for MIL-STD-1760 Crimp, Metal

38999

PART NUMBER BUILDER  
Page 75

**MILITARY**  
**D38999/31**

PIN CONTACTS ONLY, SHELL SIZE 25 ONLY



**TYPE 6**  
**88-555875/76**  
**91-555875/76**

**TYPE 2**  
**88-558518/19**  
**91-558518/19**

**TYPE 1**  
**T3W-16B25-XXXX**

Series III

### TRI-START LANYARD SEPARATION FORCES

Shell Size	Straight Plug (lbs. max.)	15 Degree Pull (lbs. max.)
25	90	100

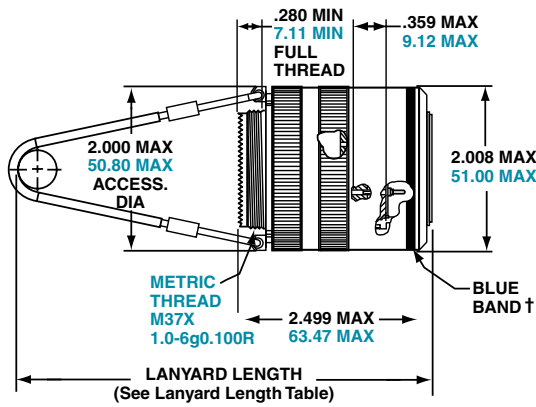

**TYPE 1**  
**(LONGER SHELL)**

† Blue band indicates rear release contact retention system  
\*\* Lanyard pulled taut against a .500 ± .13 dia. Mandrel  
All dimensions for reference only

**INSERT AVAILABILITY**  
**FAIL SAFE D38999/31**  
**FOR MIL-STD-1760**

### PIN CONTACT DATA FOR MIL-STD-1760

Insert Arrangement	Service Rating	Total Contacts	Contact			
			20	16	12 (Coax)	8 (Twinax)
25-20	N	30	10	13	4	3

### CONTACTS FOR 25-20 PATTERN

Shell Size	Arrg. Number	Number of Contacts	Size Contacts	Service Rating	Contact Location	Standard Contacts	
						Pin	Socket
25	-20	3	8	Twinax	A, H, K	M39029/90-529	M39029/91-530
		4	12	Coax	2,3 W, 5	M39029/28-211	M39029/75-416
		13	16	N	C, D, E, F, J, M, N, P, R, T, U, Y, Z	M39029/58-364	M39029/56-352
		10	20	N	B, G, L, S, V, X, 1, 4, 6, 7	M39029/58-363	M39029/56-351

Insert Arrangement	Service Rating	Total Contacts	Contact Size	
			20	10 (power)
25-11	N	11	2	9



**25-20**  
**PRIMARY INTERFACE**  
**SIGNAL SET**



**25-11**  
**AUXILIARY POWER**  
**SIGNAL SET**



8 (twinax) 10 (power) 12 (coax) 16 20

# TV Breakaway Fail-Safe Lanyard Release

## Commercial version of D38999/31, Type 6

38999

III  
II  
I  
SJT  
Access  
Aquacon

Series III

### QUICK-DISCONNECT WITH AN AXIAL PULL OF LANYARD

Amphenol offers a commercial version of D38999/31 series III, type 6 connectors. Built from the same time-tested and quality components used in its Mil-Spec counterpart, Amphenol's commercial variant is designed to accept a wider variety of insert arrangements the Mil-Spec does not include. Available in shell size 25, these fail-safe connectors adopt an incredible amount of versatility without sacrificing performance or durability. Consult Amphenol Aerospace for more information.

### FEATURES AND BENEFITS

- More versatile than the mil-spec
- 25 lanyards lengths
- Available in all size 25 arrangements
- Low force separation capabilities
- Compatible with all mil-spec backshells and accessories
- Mates to existing D38999 receptacles



# TV Breakaway Fail-Safe Lanyard Release Connector

## Commercial (88-725010, 88-725014, 88-725041) Version of D38999/31 Type 6

38999

### HOW TO ORDER

1.	2.	3.	4.	5.
Service Class	Shell Style	Insert Arrg.	Alternate Keying Position (End A)	Lanyard Length Code
88	725010-	04	P	K

1. FINISH*	
88-	Olive Drab Cadmium
91-	Electroless Nickel

\* Contact Amphenol for availability of other finishes.

2. SHELL STYLE	
725010-	D38999/31 Type 6
725014-	Extended Backskirt
725041-	Integrated Banding Platform

3. INSERT ARRANGEMENT	
04	25-4
07	25-7
11	25-11
17	25-17
20	25-20
24	25-24
26	25-26
29	25-29
35	25-35
37	25-37
41	25-41
43	25-43
46	25-46
61	25-61
62	25-62
90	25-90
F4	25-F4
187	25-187

4. KEYING		
Key Position	Pin	Socket
N	P	S
A	G	H
B	I	J
C	K	L
D	M	N
E	R	T

5. LANYARD LENGTH CODE		
Lanyard Length (in.) ± .236	Lanyard Length (mm) ± 6.0	Lanyard Length Code For Part Number
4.016	102	A
4.528	115	B
5.000	127	C
5.512	140	D
6.024	153	E
6.535	166	F
7.008	178	G
7.520	191	H
7.992	203	I
8.503	216	J
9.016	229	K
9.528	242	L
10.000	254	M
10.512	267	N
11.024	280	P
11.535	293	R
12.008	305	S
12.520	318	T
13.031	331	U
14.016	356	V
15.000	381	W
16.024	407	X
17.008	432	Y
18.031	458	Z

### INSERT ARRANGEMENTS

Shell Size & Insert Arrg. for:

Series III TV	25-04	25-07	25-08	25-11***
Service Rating	I	M	Twinax	N
Number of Contacts	48 8	97 2	8	2 9
Contact Size	20 16	22D 8 Twinax	8 Twinax	20 10

Shell Size & Insert Arrg. for:

Series III TV	25-17	25-19	25-20***	25-24
Service Rating	M	I	N	I
Number of Contacts	36 6	19	10 13 3 4	12 12
Contact Size	22D 8 Twinax	12	20 16 8 Twinax 12 Coax	16 12

# Insert Arrangements

## Commercial (88-725010 & 88-725014) Version of D38999/31 Type 6

38999

III  
II  
I  
SJT  
Access  
Aquacon

Series III



Shell Size &  
Insert Arrg. for:

Series III TV	25-26			25-29			25-35			25-37		
Service Rating	I			I			M			I		
Number of Contacts	16	5	4	29			128			37		
Contact Size	20	12	8 Coax	16			22D			16		



Shell Size &  
Insert Arrg. for:

Series III TV	25-41					25-43		25-46			25-61	
Service Rating	N/Inst.					I		I			I	
Number of Contacts	22	3	11	2	3	23	20	40	4	2	61	
Contact Size	22D	20	16	12 Coax	8 Twinax	20	16	20	16	8 Coax †	20	

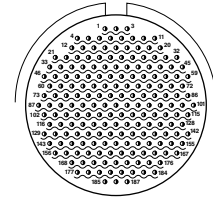
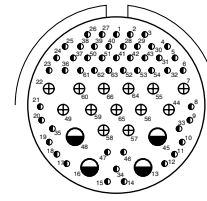
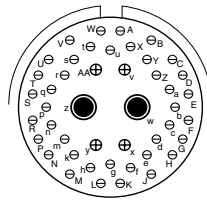
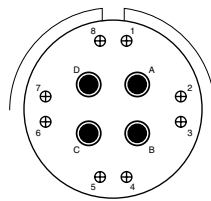

Shell Size &  
Insert Arrg. for:

Series III TV	25-62		25-90			25-F4			25-187 HD	
Service Rating	I		I			Size 22D=M, Balance =I			N	
Number of Contacts	8	4	40	4	2	49	13	4	187	
Contact Size	16	8	20	16	8 Twinax	22D	16	12	23	

Ground Plane Only

### SPECIALS



Shell Size &  
Insert Arrg. for:

Series III TV	25-92		25-97			25-16		25L-3		25L-7	
Service Rating	M		M			M		II		II	
Number of Contacts	92	9	26	3	13	6	2	1	2	7	
Contact Size	22D	16	22D	16	12	20	4	8	4	8	

# TV Breakaway Fail-Safe Lanyard Release Connector

## Commercial (88-725014 & 88-725041) Version of D38999/31 Type 6

38999

88-725041 INTEGRATED BANDING PLATFORM



88-725014 EXTENDED BACKSKIRT



Series III

A



# D38999 Type Hybrid Breakaway – Series III

## Lower Profile Lanyard Release Plug, Crimp

### METAL SHELLS WITH COMPOSITE OPERATING SLEEVE

New Hybrid Lanyard Breakaway Fail-Safe connector with a composite thermoplastic outer operating sleeve for greater durability.

This new hybrid breakaway is the breakaway of choice for the Navy F-18 Program. Amphenol's hybrid lanyard design offers greater durability over D38999 aluminum and composite designs because of its ability to handle abuse taken after weapons release.

Other advantages include:

- Lower profile compared to full metal breakaway Fail-Safe connectors
- Less weight

This Hybrid Breakaway meets the applicable requirements of MIL-DTL-38999/31 including random & sine vibration, ice resistance, fluid immersion and hydrolytic stability tests. (Test reports are available upon request).

Currently the hybrid breakaway is available in shell sizes 25 and 17. It uses standard inserts available for breakaway plugs sizes 25 and 17, and is also available with inserts 25-20 and 25-11 for MIL-STD-1760. These hybrid connectors will accommodate the standard backshells for breakaway connectors shown on Accessories section or the backshell section.

[Consult Amphenol Aerospace for ordering of the new hybrid breakaway connectors.](#)



*New Hybrid Lanyard Release Plugs  
(Metal inside shells and Composite,  
lower profile outer sleeves)*

CONDITION/TEST	DESCRIPTION	REFERENCE
Durability	400 complete mating/unmating cycles	MIL-DTL-38999/31D
High Impact Shock	Nine hammer blows from 1,3 and 5 feet, three each in three axes on mounting panel.	MIL-S- 901D
Vibration	10 to 2000Hz in three perpendicular axes, 4 hours in each axis for a total of 12 hours with no fracturing or breaking of parts.	MIL-STD-202F, Method 204
Ice Resistance	Pull tested after conditioned with Ice water at -18C for 35 minutes.	MIL-DTL-38999/31D
Fail Safe Disengagement	Rotationally unmated 180° from full mate position and pull tested in both a straight direction and at 15°.	MIL-DTL-38999/31D
High Speed Pull Separation	100 cycles at 30 feet per second.	MIL-DTL-38999/31D

### STORES MANAGEMENT TYPE II, RAIL LAUNCH

#### Plugs and Receptacles that meet MIL-STD-1760

Amphenol provides a Breakaway Rail Launch connector that is designed for use on aircraft that carry rail launch missiles such as AMRAAM.

These connectors are designed for blindmating of stores on rail launch applications. They consist of a buffer plug and a missile receptacle that meet the specifications of MIL-STD-1760 Stores Management.

Other features and benefits include:

- Designed to MIL-C-83538 specifications
- Bayonet and push pull coupling
- Use standard MIL-DTL-38999 crimp termination with power, coax and twinax contacts also available
- Buffer provides flame barrier
- Buffers are replaceable

[Consult Amphenol Aerospace for more information and ordering.](#)



*Stores Management Type II  
Rail Launch Connectors*

38999

III

II

I

SJT

Access

Aquacon

Series III

A

# MIL-DTL-38999/ 27599, Series II JT

# MIL-DTL-38999/ 27599, Series I LJT



Series I LJT



Series II JT

## FEATURES & BENEFITS

Amphenol® LJT and JT Series subminiature cylindrical connectors are qualified to MIL-DTL-38999\*, Series I and II respectively. These connectors were developed to meet the needs of the aerospace industry, and provided the impetus for development of the MIL-C-38999 specifications, which has been superseded by MIL-DTL-38999. Meeting or exceeding MIL-DTL-38999 requirements, Amphenol® JT/LJT connectors feature:

- Lightweight, Space Saving Design
- Contact Protection - 100% scoop-proof LJT design prevents bent pins and short circuits during mating
- Quick Positive Coupling - 3 point bayonet lock system
- Mismatching Eliminated - with 5 key/keyway design
- Error Proof Alternate Positioning - insured by different key/ keyway locations
- EMI Shielding - grounding fingers standard in LJT Series; optional in JT Series
- Nine Shell Sizes and a Variety of Shell Styles
- Contact Options - size 8, 10, 12, 16, 20, 22M and 22D Crimp, Solder, PCB, Wire wrap, Coax, Twinax, Triax, Thermocouple, Fiber Optic and Filter
- Fixed Solder Contacts - Amphenol MIL-DTL-38999 Series I LJT and II JT, are available in solder versions as both Commercial and Military qualified to MIL-DTL-27599
- Hermetic - air leakage limited to  $1 \times 10^{-7}$  cm<sup>3</sup> per second optional
- “Breakaway” Lanyard Release Style - available in LJT plugs. Provides quick disconnect of the connector plug and receptacle with axial pull on the lanyard. See pages 94-96.
- Inventory Support Commonality - uses standard MIL-DTL-38999 contacts, insert arrangements and application tools.
- RoHS Compliant Product Available - Consult Amphenol Aerospace Operations.



### TABLE OF CONTENTS

MIL-DTL-38999, Series I and II	
Shell Size & Insert Arrangement Availability	2-5
Insert Arrangement Drawings	6-10
PCB Insert Arrangements	14-28
Contact rating/Service Rating/Sealing Plugs	29-31
Series II	84-111
Series I	112-141

# MIL-DTL-38999, Series II JT MIL-DTL-38999, Series I LJT

## COMPONENTS

Shell components are impact extruded or machined bar stock aluminum. Standard plating on shell components is cadmium over nickel. Many finishes are optional (see "Specifications" page 32). Hermetic seal receptacles are available in carbon steel or stainless steel shells. Dependable 5 key/keyway polarization with bayonet lock coupling is incorporated to aid and assure positive mating.

Insert material is a rigid dielectric with excellent electrical characteristics, providing durable protection for molded-in solder type contacts. Contrasting letter or number designations are used on insert faces.

A fluorinated silicone interfacial seal wafer is featured on the mating face of "crimp type pin" inserts. This assures complete electrical isolation of pins when connector halves are mated. In addition, a main joint gasket is installed in the receptacle for moisture sealing between connector halves. Both features are also available for hermetic receptacles.

## CONTACTS

Maximum design flexibility is built into the JT/LJT Series, with a minimum of 2 to a maximum of 128 circuits per connector in a wide variety of contact arrangements. Contacts are available in sizes 8, 10, 12, 16, 20, 22, 22D and 22M with standard 50 micro inch minimum gold plating (100 micro inches optional). All socket contacts are probe proof. Crimp type rear removable contacts are featured in JT-R and LJT-R connectors. Solder termination contacts are also available, as well as PCB, wire wrap, thermocouple, fiber optic, coaxial, triaxial and twinax contact options.

## OPTIONAL FEATURES

High temperature capability of 392°F is available only in JTS or LJTS crimp type connectors. High temperature versions feature gold plated contacts, high temperature shell plating, stainless steel coupling nut spring, and epoxy inserts/fluorinated silicone grommet combination. Standard temperature capability for both solder and crimp is 302°F.

The JTN or LJTN type connectors are available for  $N_2O_4$  resistance provided they are mated, and un-grommeted rear faces are suitably protected.

For information on Fail-Safe Lanyard Release style plugs, see pages 141.



MIL-DTL-38999  
Series I LJT



MIL-DTL-38999  
Series II JT

Where proof of high reliability and lot control is required, MS approved equivalents to most proprietary JT and LJT connectors are available.

\* MIL-DTL-38999 Series I supersedes MIL-C-38999 Series I.  
MIL-DTL-38999 Series II supersedes MIL-C-38999 Series II.

## B



### TABLE OF CONTENTS FOR SECTION B

MIL-DTL-38999, Series II JT

Shell Size & Insert Arrangement Availability . . . . .	2-5
Insert Arrangement Drawings . . . . .	6-10
PCB Insert Arrangements . . . . .	14-28
Contact rating/Service Rating/Sealing Plugs . . . . .	29-31
How to Order (Military) . . . . .	85-86
How to Order (Commercial) . . . . .	87-89

#### JT Shell Styles:

Crimp Wall Mounting Receptacle JT00R (MS27472)	90
Crimp Wall Mounting Receptacle for Back Panel Mounting JTPQ00R (MS27497) . . . . .	91
Crimp Line Receptacle JT01R . . . . .	92
Crimp Box Mounting Receptacles JT02RE (MS27499), JT02RE(053) (MS27513) . . . . .	93
Crimp Box Mounting Receptacle for Back Panel Mounting JTP02R (MS27508) . . . . .	94
Crimp Jam Nut Receptacle JT07R (MS27474) . . . . .	95
Crimp Jam Nut Receptacle (Miniature Jam Nut Mounting Dimensions) JTL07R . . . . .	96
Crimp Straight Plug JT06R (MS27473) . . . . .	97
Crimp Straight Plug with Grounding Fingers JTG06R (MS27484) . . . . .	98
Crimp 90° Plug JT08R (MS27500) . . . . .	99

#### HERMETIC:

Hermetic Wall Mounting Receptacle JT00 (MS27475), Hermetic Box Mounting Receptacle JT02 (MS27476) . . . . .	100
Hermetic Jam Nut Receptacle JT07 (MS27477 & MS27483)	
Hermetic Solder Mounting Receptacle JTI (MS27478 & MS27508) . . . . .	101
Solder Wall Mounting Receptacle JT00 (MS27334), Solder Box Mounting Receptacle JT02 (MS27335) . . . . .	102
Solder Straight Plug JT06 (MS27336), Solder Straight Plug with Grounding Ring JTG06A . . . . .	103
Solder Jam Nut Receptacle JT07 (MS27337), Solder 90° Plug JT08 . . . . .	104

#### PCB:

PCB Wall Mounting Receptacle (JTPQ00R) . . . . .	105
PCB Box Mounting Receptacle, Back Panel (JTP02R) . . . . .	106
PCB Jam Nut Receptacle (JT07) . . . . .	107
PCB Wall Mounting Receptacle Hermetic (JT00) . . . . .	108
PCB box Mounting Receptacle Hermetic (JT02) . . . . .	109
PCB Jam Nut Receptacle Hermetic (JT07) . . . . .	110
PCB Solder Mounting Receptacle Hermetic (JTI) . . . . .	111

#### Accessories:

Section F . . . . .	164-183
---------------------	---------

# Military to Commercial Shell Style Conversion Table

## How to Order (Military)

MILITARY	DESCRIPTION	COMMERCIAL
<b>MS27472</b>	Crimp Wall Mounting Receptacle	<b>JT00</b>
<b>MS27497</b>	Crimp Wall Mounting Receptacle (Back Panel Mounting)	<b>JTPQ00</b>
<b>MS27499</b>	Crimp Box Mounting Receptacle	<b>JT02, JTS02, JTN02</b>
<b>MS27513</b>	Crimp Box Mounting Receptacle with grommet	<b>JT02, JTS02, JTN02</b>
<b>MS27508</b>	Crimp Box Mounting Receptacle (Back Panel Mounting)	<b>JTP02, JTPN02, JTPS02</b>
<b>MS27473</b>	Crimp Straight Plug	<b>JT06, JTS06, JTN06</b>
<b>MS27484</b>	Crimp Straight Plug with Grounding Fingers	<b>JTG06, JTNG06</b>
<b>MS27474</b>	Crimp Jam Nut Receptacle	<b>JT07, JTS07, JTN07</b>
<b>MS27500</b>	Crimp 90° plug	<b>JT08, JTS08, JTN08</b>
<b>MS27475</b>	Hermetic Wall Mounting Receptacle	<b>JT00</b>
<b>MS27476</b>	Hermetic Box Mounting Receptacle	<b>JT02, JTS02</b>
<b>MS27477</b>	Hermetic Jam Nut Receptacle	
<b>MS27478</b>	Hermetic Solder Mounting Receptacle	<b>JTSIY</b>
<b>MIL-DTL-27599</b>		
<b>MS27334</b>	Solder Wall Mounting Receptacle	<b>JT00</b>
<b>MS27335</b>	Solder Box Mounting Receptacle	<b>JT02</b>
<b>MS27336</b>	Solder Straight Plug	<b>JT06</b>
<b>MS27337</b>	Solder Jam Mounting Receptacle	<b>JT07</b>

38999

III

II

I

SJT

Access

Aquacon

**Series II**

## HOW TO ORDER - MILITARY SERIES II

1.	2.	3.	4.	5.	6.	7.
MS Number	Service Class	Shell Size	Finishes	Insert Arrangement	Contact Style (P or S)	Alternate Keying Position
<b>MS27472</b>	<b>E</b>	<b>14</b>	<b>A</b>	<b>18</b>	<b>P</b>	<b>A</b>

### 1. MS NUMBER SERIES II JT

<b>MS27472</b>	Crimp Wall Mount Receptacle
<b>MS27497</b>	Crimp Wall Mount Receptacle (Back Panel Mounting)
<b>MS27499</b>	Crimp Box Mounting Receptacle
<b>MS27513</b>	Crimp Box Mounting Receptacle with grommet
<b>MS27508</b>	Crimp Box Mounting Receptacle (Back Panel Mounting)
<b>MS27473</b>	Crimp Straight Plug
<b>MS27484</b>	Crimp Straight Plug with Grounding Fingers
<b>MS27474</b>	Crimp Jam Nut Receptacle
<b>MS27500</b>	Crimp 90° plug
<b>MS27475</b>	Hermetic Wall Mounting Receptacle
<b>MS27476</b>	Hermetic Box Mounting Receptacle
<b>MS27477</b>	Hermetic Jam Nut Receptacle
<b>MS27478</b>	Hermetic Solder Mounting Receptacle
<b>MIL-DTL-27599</b>	
<b>MS27334</b>	Solder Wall Mount Receptacle
<b>MS27335</b>	Solder Box Mounting Receptacle
<b>MS27336</b>	Solder Straight Plug
<b>MS27337</b>	Solder Jam Mounting Receptacle

### 2. HERMETIC SERVICE CLASS

<b>WALL MOUNT (475)</b>	
<b>BOX MOUNT (476)</b>	
<b>JAM NUT (477)</b>	
<b>SOLDER MOUNT (478)</b>	
<b>Y</b>	Hermetically interfacial seal

Service Class continues on next page.

# MIL-DTL-38999/27599, Series II JT

## How to Order (Military)

38999

Series II

2. SERVICE CLASS						
CRIMP		SOLDER				
WALL MOUNT (472)	BOX MOUNT (499)	WALL MOUNT (334)	JAM NUT (337)	BOX MOUNT (335)		
WALL MOUNT BPM (497)	BOX MOUNT GROMMET (513)	STRAIGHT PLUG (336)				
STRAIGHT PLUG (473)	BOX MOUNT BPM (508)					
STRAIGHT PLUG GF (484)	90° Plug (500)					
JAM NUT (474)						
<b>E</b>	<b>E</b>				Environmental crimp applications. Box Mount versions using spacer grommets are not environmental.	
<b>P</b>		<b>P</b>	<b>P</b>		Potting crimp applications. Supplied with spacer grommet and potting boot.	
<b>T</b>		<b>T</b>		<b>T</b>	Environmental applications. Supplied without rear accessories. Design provides serrations on rear threads of shells.	

1.	2.	3.	4.	5.	6.	7.
MS Number	Service Class	Shell Size	Finishes	Insert Arrangement	Contact Style (P or S)	Alternate Keying Position
<b>MS27472</b>	<b>E</b>	<b>14</b>	<b>A</b>	<b>18</b>	<b>P</b>	<b>A</b>

### 3. & 5. SHELL SIZE

See table on page 2-5

Shell Size & Insert Arrangement are on pages 2-5. First number represents Shell Size, second number is the Insert Arrangement. Place Shell Size in box 3 and Insert Arrangement in box 5.

### 4. FINISHES

Finish	Military Finish Data
Cadmium plated nickel base 175°C	<b>A</b>
Olive drab cadmium plate nickel base 175°C	<b>B</b>
Electroless nickel 200°C	<b>F</b>
Electroless nickel, space compatible 200°C	
Anodic coating (Alumilite) 200°C	<b>C</b>
Chromate treated (Iridite 14-2) 125°C	
Passivated steel 200°C	<b>E</b>
Nickel-PTFE 175°C	

### 6. CONTACTS

<b>P</b>	Pin Contacts
<b>S</b>	Socket Contacts



RELATIVE POSSIBLE POSITION OF ROTATED MASTER KEYWAY (front face of receptacle shown)

### JT Key/Keyway Rotation

AB ANGLE OF ROTATION (Degrees)						
Shell Size	Normal	A	B	C	D	
8	100°	82°	-	-	118°	
10	100°	86°	72°	128°	114°	
12	100°	80°	68°	132°	120°	
14	100°	79°	66°	134°	121°	
16	100°	82°	70°	130°	118°	
18	100°	82°	70°	130°	118°	
20	100°	82°	70°	130°	118°	
22	100°	85°	74°	126°	115°	
24	100°	85°	74°	126°	115°	

### 7. SELECT AN ALTERNATE KEYING POSITION

“A” designates Alternate keying connector assembly. Other basic alternate keys are “B”, “C” and “D”. No letter required for normal rotation (no rotation) position.

A plug with a given rotation letter will mate with a receptacle with the same rotation letter. The AB angle for a given connector is the same whether it contains pins or sockets. Only the master key/keyway rotates in the shell, and the minor keys are fixed.

AB angles shown are viewed from the front face of the connector, a receptacle is shown below. The angles for the plug are exactly the same except the direction of rotation is opposite of that shown for the receptacle.

The “N” designation is not referenced in part number, it is omitted.

B

# MIL-DTL-38999/27599, Series II JT

## How to Order (Commercial)

1. Type & Style	2. Service Class	3. Shell Size-Insert Arrg.	4. Contact Type	5. Alternate Position	6. Strain Relief/Finish Variation Suffix	
JT00	RT	9-35	P	B	SR	(014)

### MIL-DTL-38999, SERIES II

		Standard Junior Tri-Lock	High Temperature	Chemical and Fuel Resistant	Miniature Mounting Dimensions	Miniature Mounting Dimensions/ Chemical Resistant	Miniature Mounting Dimensions/ High Temperature
<b>Receptacle Crimp</b>	Wall Mounting Receptacle	JT00	JTS00	JTN00	-	-	-
	Box Mounting Receptacle	JT02	JTS02	JTN02	-	-	-
	Line Receptacle	JT01	JTS01	JTN01	-	-	-
	Jam Nut Receptacle	JT07	JTS07	JTN07	JTL07	JTLN07	JTLS07
	Wall Mounting Receptacle (Back Panel)	JTPQ00	JTPS00	JTPN00			
	Box Mounting Receptacle (Back Panel)	JTP02	JTPS02	JTPN02			

<b>Plugs</b>	Straight Plug	JT06	JTS06	JTN06			
	90° Plug	JT08	JTS08	JTN08			
	90° Plug with Grounding Fingers	JTG08		JTNG08			

CONNECTOR TYPE & STYLE

<b>Printed Circuit Board</b>	Wall Mounting Receptacle (Back Panel)	88/91 56973	See page 105 for part number order guide				
	Box Mounting Receptacle (Back Panel)	88/91 56974	See page 106 for part number order guide				
	Jam Nut Receptacle	88/91 56975	See page 107 for part number order guide				
	Wall Mounting Receptacle (Hermetic)	10-62643	See page 108 for part number order guide				
	Box Mounting Receptacle (Hermetic)	10-62646	See page 109 for part number order guide				
	Jam Nut Receptacle (Hermetic)	10-62644	See page 110 for part number order guide				

<b>Hermetic</b>	Wall Mounting Receptacle	JT00	JTS00	JTN00			
	Box Mounting Receptacle	JT02	JTS02	JTN02			
	Jam Nut Receptacle	JT07	JTS07	JTN07	JTL07	JTLN07	JTLS07
	Solder Mounting Receptacle	JTI	JTSI	JTNI			

Wall Mounting Receptacle



Box Mounting Receptacle



Straight Plug



Jam Nut Receptacle



90° Plug



Solder Mounting Receptacle



# MIL-DTL-38999/ 27599, Series II JT

## How to Order (Commercial)

38999

### 2. SELECT A SERVICE CLASS

1.	2.	3.	4.	5.	6.
Type & Style	Service Class	Shell Size-Insert Arrg.	Contact Type	Alternate Position	Strain Relief/Finish Variation Suffix
JT00	<b>RT</b>	9-35	P	B	SR (014)

### 2. SERVICE CLASS

CRIMP			SOLDER			90° PLUG GR	
WALL MOUNT	BOX MOUNT	JAMNUT (JTL)	WALL MOUNT	STRAIGHT PLUG	STRAIGHT PLUG GR		
WALL MOUNT BPM	BOX MOUNT BACKPANEL	90° PLUG	BOX MOUNT				
LINE			JAM NUT				
STRAIGHT PLUG							
STRAIGHT PLUG GF							
JAM NUT							
<b>RE</b>	<b>RE</b>						Environmental crimp applications. Box Mount versions using spacer grommets are not environmental.
<b>RP</b>		<b>RP</b>	<b>P</b>	<b>P</b>		<b>P</b>	Potting crimp applications. Supplied with spacer grommet and potting boot.
<b>RT</b>		<b>RT</b>					Environmental applications. Supplied without rear accessories. Design provides serrations on rear threads of shells.
			<b>A</b>	<b>A</b>	<b>A</b>		General applications- applicable with strain relief.
			<b>C</b>				Pressurized applications- applicable with strain relief.

### 2. HERMETIC SERVICE CLASS

WALL MOUNT	
BOX MOUNT	
JAM NUT	
SOLDER MOUNT	
<b>Y</b>	Hermetically interfacial seal
<b>H</b>	Hermetic applications- Fused compression glass sealed inserts. Leakage rate less than .01 micron cu. ft./hr. (1 x 10 <sup>-7</sup> cc/sec.) at 15 psi differential.

### 3. SELECT A SHELL SIZE & INSERT ARRANGEMENT SEE PAGE 2-5

First number represents Shell Size, second number is the Insert Arrangement.

1.	2.	3.	4.	5.	6.
Type & Style	Service Class	Shell Size-Insert Arrg.	Contact Type	Alternate Position	Special Variations
		<b>22-2</b>	<b>P</b>		

### 4. SELECT A CONTACT TYPE

	Designates
<b>P</b>	Pin Contacts
<b>S</b>	Socket Contacts

B



1.	2.	3.	4.	<b>5.</b>	6.
Connector Type	Service Class	Shell Size Insert Arrg.	Contact Type	<b>Alternate Position</b>	Special Variations
				<b>A</b>	



RELATIVE POSSIBLE POSITION OF ROTATED MASTER KEYWAY (front face of receptacle shown)

### 5. SELECT AN ALTERNATE KEYING POSITION

“A” designates Alternate keying connector assembly. Other basic alternate keys are “B”, “C” and “D”. No letter required for normal rotation (no rotation) position.

A plug with a given rotation letter will mate with a receptacle with the same rotation letter. The AB angle for a given connector is the same whether it contains pins or sockets. Only the master key/keyway rotates in the shell, and the minor keys are fixed.

AB angles shown are viewed from the front face of the connector, a receptacle is shown below. The angles for the plug are exactly the same except the direction of rotation is opposite of that shown for the receptacle.

The “N” designation is not referenced in part number, it is omitted.

### JT Key/Keyway Rotation

Shell Size	AB ANGLE OF ROTATION (Degrees)				
	Normal	A	B	C	D
8	100°	82°	-	-	118°
10	100°	86°	72°	128°	114°
12	100°	80°	68°	132°	120°
14	100°	79°	66°	134°	121°
16	100°	82°	70°	130°	118°
18	100°	82°	70°	130°	118°
20	100°	82°	70°	130°	118°
22	100°	85°	74°	126°	115°
24	100°	85°	74°	126°	115°

1.	2.	3.	4.	5.	<b>6.</b>
Connector Type	Service Class	Shell Size-Insert Arrg.	Contact Type	Alternate Position	<b>Special Variations</b>
					<b>( )</b>

### 6. SELECT A STRAIN RELIEF OPTION OR FINISH VARIATION SUFFIX

Strain Relief Options: “SR” designates a strain relief clamp. Strain reliefs are available only on Service Class “A”, “C” and “RE” (see step 2. Service Class) Finish Variation Suffix: See finish variations available in table to your right.

Finish	Military Finish Data	Finish Suffix	Finish Plus “SR” Suffix
Cadmium plated nickel base 175°C	A		<b>(SR)</b>
Olive drab cadmium plate nickel base 175°C	B	<b>(014)</b>	<b>(386)</b>
Electroless nickel 200°C	F	<b>(023)</b>	<b>(424)</b>
Electroless nickel, space compatible 200°C		<b>(453)</b>	<b>(467)</b>
Anodic coating (Alumilite) 200°C	C	<b>(005)</b>	<b>(300)</b>
Chromate treated (Iridite 14-2) 125°C		<b>(011)</b>	<b>(344)</b>
Passivated steel 200°C	E	-	-
Nickel-PTFE 175°C		<b>(045)</b>	<b>(582)</b>
Zinc-Nickel Plated 175°C		<b>(033)</b>	

III
<b>II</b>
I
SJT
Access
Aquacon

**Series II**

**B**

# Wall Mounting Receptacle - Crimp

**Military (MS27472 & MS27479), Commercial (JT00, JTS00 & JTN00) (SR)**

38999

PART NUMBER BUILDER Page 85-89

**MILITARY**  
 MS27472E  
 MS27472P  
 MS27472T  
 MS27479E  
 MS27479T

**Commercial**  
 JT00RT, JT00RE, JT00RP  
 JTS00RT, JTS00RE, JTS00RP  
 JTN00RT, JTN00RE, JTN00RP



**Commercial**  
 \* JT00RT-XX-XXX  
 \*\* JTS00RT-XX-XXX  
 \*\*\* JTN00RT-XX-XXX

**Military**  
 MS27472T  
 MS27479T



**Commercial**  
 \* JT00RE-XX-XXX  
 \*\* JTS00RE-XX-XXX  
 \*\*\* JTN00RE-XX-XXX

**Military**  
 MS27472E  
 MS27479E



**Commercial**  
 \* JT00RP-XX-XXX  
 \*\* JTS00RP-XX-XXX  
 \*\*\* JTN00RP-XX-XXX

**Military**  
 MS27472P



**Commercial**  
 \* JT00RE-XX-XXX (SR)  
 \*\* JTS00RE-XX-XXX (SR)  
 \*\*\* JTN00RE-XX-XXX (SR)

⊕ .005 DIA ⊖

- \* Standard Junior Tri-Lock
- \*\* High temperature version
- \*\*\* Clear iridite finish (gold color), N<sub>2</sub>O<sub>4</sub> resistant

Shell Size	F Dia. +.010 -0.025	F <sup>1</sup> Dia. ±.010	L Max.	L <sup>1</sup> Max.	L <sup>2</sup> Max.	L <sup>3</sup> Max.	N +.001 -0.005	R (TP)	S ±.016	T ±.005	V Thread UNEF Class 2A (Plated)	KK Max.	KK <sup>1</sup> Dia. Max.	KK <sup>2</sup> Dia. Max.
8	.125	.444	1.094	.609	.547	.500	.473	.594	.812	.120	.4375-28	.812	.625	.578
10	.188	.558	1.094	.609	.547	.500	.590	.719	.938	.120	.5625-24	.875	.750	.703
12	.312	.683	1.094	.609	.547	.500	.750	.812	1.031	.120	.6875-24	1.000	.875	.828
14	.375	.808	1.344	.609	.547	.500	.875	.906	1.125	.120	.8125-20	1.125	1.000	.953
16	.500	.909	1.344	.609	.547	.500	1.000	.969	1.219	.120	.9375-20	1.188	1.125	1.078
18	.625	1.034	1.344	.609	.547	.500	1.125	1.062	1.312	.120	1.0625-18	1.438	1.250	1.203
20	.625	1.159	1.344	.609	.547	.500	1.250	1.156	1.438	.120	1.1875-18	1.438	1.375	1.328
22	.750	1.284	1.469	.609	.547	.500	1.375	1.250	1.562	.120	1.3125-18	1.625	1.500	1.453
24	.800	1.409	1.469	.688	.547	.500	1.500	1.375	1.688	.147	1.4375-18	1.719	1.625	1.578

All dimensions for reference only.

B

# Wall Mounting Receptacle (Back Panel) - Crimp Military (MS27497), Commercial (JTPQ00 & JTPSQ00)

PART NUMBER BUILDER Page 85-89

**MILITARY**  
MS27497E  
MS27497P  
MS27497T

**Commercial**  
JTPQ00RE, JTPQ00RP, JTPQ00RT  
JTPSQ00RT



⊕ .005 DIA M

\* Standard Junior Tri-Lock  
\*\* High temperature version

Shell Size	F Dia. +.010 -0.025	F' Dia. ±.010	L Max.	L' Max.	N +.001 -0.005	P Max. Panel Thickness	S R (TP)	T ±.016	T ±.005	V Thread UNEF Class 2A (Plated)	AD Dia. ±.005	KK Max.	KK <sup>1</sup> Dia. Max.	KK <sup>2</sup> Dia. Max.	SS Dia. +.000 -0.016
8	.125	.444	1.140	.468	.473	.142	.594	.812	.120	.4375-28	.516	.781	.625	.578	.563
10	.188	.558	1.140	.468	.590	.142	.719	.938	.120	.5625-24	.633	.844	.750	.703	.680
12	.312	.683	1.140	.468	.750	.142	.812	1.031	.120	.6875-24	.802	.969	.875	.828	.859
14	.375	.808	1.375	.468	.875	.142	.906	1.125	.120	.8125-20	.927	1.094	1.000	.953	.984
16	.500	.909	1.375	.468	1.000	.142	.969	1.219	.120	.9375-20	1.052	1.154	1.125	1.078	1.108
18	.625	1.034	1.375	.468	1.125	.142	1.062	1.312	.120	1.0625-18	1.177	1.406	1.250	1.203	1.233
20	.625	1.159	1.375	.468	1.250	.142	1.156	1.438	.120	1.1875-18	1.302	1.406	1.375	1.328	1.358
22	.750	1.284	1.516	.468	1.375	.142	1.250	1.562	.120	1.3125-18	1.427	1.594	1.500	1.453	1.483
24	.800	1.409	1.500	.540	1.500	.142	1.375	1.688	.147	1.4375-18	1.552	1.688	1.625	1.578	1.610

# Line Receptacle - Crimp

## Commercial (JT01, JTS01 & JTN01)

38999

PART NUMBER BUILDER Page 85-89

Commercial

JT01RE, JT01RP, JT01RT  
 JTS01RE, JTS01RP, JTS01RT  
 JTN01RE, JTN01RP, JTN01RT



Commercial  
 \* JT01RT-XX-XXX  
 \*\* JTS01RT-XX-XXX  
 \*\*\* JTN01RT-XX-XXX



Commercial  
 \* JT01RE-XX-XXX  
 \*\* JTS01RE-XX-XXX  
 \*\*\* JTN01RE-XX-XXX



Commercial  
 \* JT01RP-XX-XXX  
 \*\* JTS01RP-XX-XXX  
 \*\*\* JTN01RP-XX-XXX



Commercial  
 \* JT01RE-XX-XXX (SR)  
 \*\* JTS01RE-XX-XXX (SR)  
 \*\*\* JTN01RE-XX-XXX (SR)

- \* Standard Junior Tri-Lock
- \*\* High temperature version
- \*\*\* Clear iridite finish (gold color), N<sub>2</sub>O<sub>4</sub> resistant

Shell Size	C Max.	F Dia. +.010	F¹ Dia. +.010 -0.025	L Max.	L¹ Max.	N Dia. +.001 -0.005	S +.017 -0.016	V Thread UNEF Class 2A (Plated)	KK Dia. Max.	KK¹ Dia. Max.	KK² Max.
8	.965	.444	.125	1.031	1.562	.473	.812	.4375-28	.578	.625	.812
10	1.089	.558	.188	1.031	1.562	.590	.938	.5625-24	.703	.750	.875
12	1.183	.683	.312	1.031	1.562	.750	1.031	.6875-24	.828	.875	1.000
14	1.277	.808	.375	1.031	1.812	.875	1.125	.8125-20	.953	1.000	1.125
16	1.371	.909	.500	1.031	1.812	1.000	1.219	.9375-20	1.078	1.125	1.188
18	1.465	1.034	.625	1.031	1.812	1.125	1.312	1.0625-18	1.203	1.250	1.438
20	1.589	1.159	.625	1.031	1.812	1.250	1.438	1.1875-18	1.328	1.375	1.438
22	1.715	1.284	.750	1.031	1.938	1.375	1.562	1.3125-18	1.453	1.500	1.625
24	1.838	1.409	.800	1.109	1.938	1.500	1.688	1.4375-18	1.578	1.625	1.719

All dimensions for reference only.

B

# Box Mounting Receptacle - Crimp

## Military (MS27499 & MS27513), Commercial (JT02) (053)

PART NUMBER BUILDER Page 85-89

**MILITARY**  
MS27499E  
MS27513E

**Commercial**

**JT02RE**  
**JTS02RE**  
**JTN02RE**



**Commercial**  
\* JT02RE-XX-XXX  
\*\* JTS02RE-XX-XXX  
\*\*\* JTN02RE-XX-XXX

**Military**  
MS27499E

**Commercial- With Grommet**  
\* JT02RE-XX-XXX (053)  
\*\* JTS02RE-XX-XXX (053)  
\*\*\* JTN02RE-XX-XXX (053)

**Military- With Grommet**  
MS27513E



- \* Standard Junior Tri-Lock
- \*\* High temperature version
- \*\*\* Clear iridite finish (gold color),  $\text{N}_2\text{O}_4$  resistant

Shell Size	L Max.	N $+0.001$ / $-0.005$	R (TP)	S $\pm 0.016$	T Dia. $\pm 0.005$	KK Dia. Max.
8	.286	.473	.594	.812	.120	.438
10	.286	.590	.719	.938	.120	.563
12	.286	.750	.812	1.031	.120	.688
14	.286	.875	.906	1.125	.120	.813
16	.286	1.000	.969	1.219	.120	.938
18	.286	1.125	1.062	1.312	.120	1.047
20	.286	1.250	1.156	1.438	.120	1.172
22	.286	1.375	1.250	1.562	.120	1.297
24	.286	1.500	1.375	1.688	.147	1.422

All dimensions for reference only.

NOTE: For applications requiring an environmental seal, please refer to JT00R, page 91.

- III
- II
- I
- SJT
- Access
- Aquacon

**Series II**

**B**

# Box Mounting Receptacle (Back Panel Mounting)

## Military (MS27508), Commercial (JTP02, JTPS02 & JTPN02)

38999

PART NUMBER BUILDER Page 85-89

MILITARY  
MS27508E

Commercial  
JTP02RE  
JTPS02RE  
JTPN02RE



Commercial  
\* JTP02RE-XX-XXX  
\*\* JTPS02RE-XX-XXX  
\*\*\* JTPN02RE-XX-XXX

Military  
MS27508E

⊕ .005 DIA (M)

- \* Standard Junior Tri-Lock
- \*\* High temperature version
- \*\*\* Clear iridite finish (gold color),  $N_2O_4$  resistant

Shell Size	L Max.	N $+0.001/-0.005$	P Max. Panel Thickness	R (TP)	S $\pm.016$	T Dia. $\pm.005$	AD Dia. $\pm.005$	KK Dia. Max.
8	.225	.473	.147	.594	.812	.120	.516	.531
10	.225	.590	.152	.719	.938	.120	.633	.656
12	.225	.750	.152	.812	1.031	.120	.802	.828
14	.225	.875	.152	.906	1.125	.120	.927	.953
16	.225	1.000	.152	.969	1.219	.120	1.052	1.078
18	.225	1.125	.152	1.062	1.312	.120	1.177	1.203
20	.225	1.250	.179	1.156	1.438	.120	1.302	1.328
22	.225	1.375	.179	1.250	1.562	.120	1.427	1.453
24	.225	1.500	.169	1.375	1.688	.147	1.552	1.578

B

# Jam Nut Receptacle

## Military (MS27474), Commercial (JT07, JTS07 & JTN07) (SR)

PART NUMBER BUILDER Page 85-89

**MILITARY**  
**MS27474E**  
**MS27474P**  
**MS27474T**

**Commercial**

**JT07RE, JT07RP, JT07RT**  
**JTS07RE, JTS07RP, JTS07RT**  
**JTN07RE, JTN07RP, JTN07RT**



**Commercial**  
\* **JT07RE-XX-XXX (SR)**  
\*\*\* **JTS07RE-XX-XXX (SR)**  
\*\*\*\* **JTN07RE-XX-XXX (SR)**



**Commercial**      **Military**  
\* **JT07RE-XX-XXX**      **MS27474E**  
\*\*\* **JTS07RE-XX-XXX**  
\*\*\*\* **JTN07RE-XX-XXX**



**Commercial**      **Military**  
\* **JT07RP-XX-XXX**      **MS27474P**  
\*\*\* **JTS07RP-XX-XXX**  
\*\*\*\* **JTN07RP-XX-XXX**



**Commercial**      **Military**  
\* **JT07RT-XX-XXX**      **MS27474T**  
\*\*\* **JTS07RT-XX-XXX**  
\*\*\*\* **JTN07RT-XX-XXX**

- ★ .059 Dia. Min. 3 lockwire holes.  
Formed lockwire hole design (6 holes) is optional.
- + "D" shaped mounting hole dimensions.
- \* Standard Junior Tri-Lock
- \*\* Panel Thickness
- \*\*\* High temperature version
- \*\*\*\* Clear iridite finish (gold color), N<sub>2</sub>O<sub>4</sub> resistant

Shell Size	A+ +.000 -.010	C Max.	F Dia. +.010 -.025	F <sup>1</sup> Dia.	H Hex +.017 -.016	L Max.	L <sup>1</sup> Max.	L <sup>2</sup> Max.	L <sup>3</sup> Max.	M ±.005	N Dia. +.001 -.005	S ±.016	T+ +.010 -.000	V Thread UNEF Class 2A	Z ±.031	KK Max.	KK <sup>1</sup> Dia. Max.	KK <sup>2</sup> Max.	RR Thread (Plated) Class 2A
8	.830	1.390	.125	.444	1.062	.484	.453	.563	1.047	.438	.473	1.250	.884	.4375-28	.144	.812	.625	.578	.8750-20UNEF
10	.955	1.515	.188	.558	1.188	.484	.453	.563	1.047	.438	.590	1.375	1.007	.5625-24	.144	.875	.750	.703	1.0000-20UNEF
12	1.084	1.640	.312	.683	1.312	.484	.453	.563	1.047	.438	.750	1.500	1.134	.6875-24	.144	1.000	.875	.828	1.1250-18UNEF
14	1.208	1.765	.375	.808	1.438	.484	.453	.563	1.297	.438	.875	1.625	1.259	.8125-20	.144	1.125	1.000	.953	1.2500-18UNEF
16	1.333	1.953	.500	.909	1.562	.484	.453	.563	1.297	.438	1.000	1.781	1.384	.9375-20	.144	1.188	1.125	1.078	1.3750-18UNEF
18	1.459	2.031	.625	1.034	1.688	.484	.453	.563	1.297	.438	1.125	1.890	1.507	1.0625-18	.144	1.438	1.250	1.203	1.5000-18UNEF
20	1.576	2.156	.625	1.159	1.812	.453	.422	.531	1.266	.464	1.250	2.016	1.634	1.1875-18	.188	1.438	1.375	1.328	1.6250-18UNEF
22	1.701	2.280	.750	1.284	2.000	.453	.422	.531	1.391	.464	1.375	2.140	1.759	1.3125-18	.188	1.625	1.500	1.453	1.7500-18UNS
24	1.826	2.405	.800	1.409	2.125	.375	.422	.609	1.391	.464	1.500	2.265	1.884	1.4375-18	.188	1.719	1.625	1.578	1.8750-16UN

All dimensions for reference only.

# Jam Nut Receptacle - Crimp

## Commercial (JTL07, JTLS07 & JTLN07) (SR)

38999

PART NUMBER BUILDER Page 85-89

**Commercial**  
**JTL07RE, JTL07RP**  
**JTLS07RE, JT0S7RP**  
**JTLN07RE**



**Commercial**

- \* JTL07RP-XX-XXX
- \*\*\* JTLS07RP-XX-XXX
- \*\*\*\* JTLN07RP-XX-XXX



**Commercial**

- \* JTL07RE-XX-XXX (SR)
- \*\*\* JTLS07RE-XX-XXX (SR)
- \*\*\*\* JTLN07RE-XX-XXX (SR)



**Commercial**

- \* JTL07RE-XX-XXX
- \*\*\* JTLS07RE-XX-XXX
- \*\*\*\* JTLN07RE-XX-XXX

- ★ .059 Dia. Min. 3 lockwire holes. Formed lockwire hole design (6 holes) is optional.
- + "D" shaped mounting hole dimensions.
- \* Miniature mounting dimensions
- \*\*\* High temperature version
- \*\*\*\* Clear iridite finish (gold color), N<sub>2</sub>O<sub>4</sub> resistant

Shell Size	A+	C	F Dia.	H Hex	K	L	L <sup>1</sup>	L <sup>2</sup>	M	N Dia.	P Panel Thickness		S	T+	Z	KK Dia.	KK <sup>1</sup>	RR Thread
	+0.000 -0.010	Max.	+0.010 -0.025	+0.017 -0.016	+0.011 -0.010	Max.	Max.	Max.	±.005	+0.001 -0.005	Min.	Max.	±.016	+0.010 -0.000	±.026	Max.	Max.	Class 2A
8	.542	1.077	.125	.750	.125	1.062	.641	.375	.630	.473	.062	.125	.938	.572	.047	.688	.812	.5625-24UNEF
10	.669	1.203	.188	.875	.125	1.062	.641	.375	.630	.590	.062	.125	1.062	.697	.047	.812	.875	.6875-24UNEF
12	.830	1.390	.312	1.062	.125	1.062	.641	.375	.630	.750	.062	.125	1.250	.844	.047	.938	1.000	.8750-20UNEF
14	.955	1.515	.375	1.188	.125	1.062	.641	.375	.630	.875	.062	.125	1.375	1.007	.047	1.062	1.125	1.0000-20UNEF
16	1.084	1.640	.500	1.312	.125	1.062	.641	.375	.630	1.000	.062	.125	1.500	1.134	.047	1.188	1.188	1.1250-18UNEF
18	1.208	1.765	.625	1.438	.125	1.062	.641	.375	.630	1.125	.062	.125	1.625	1.259	.047	1.312	1.438	1.2500-18UNEF
20	1.333	1.953	.625	1.562	.156	1.062	.703	.328	.755	1.250	.062	.250	1.812	1.384	.172	1.469	1.438	1.3750-18UNEF
22	1.459	2.075	.750	1.688	.156	1.062	.703	.328	.755	1.375	.062	.250	1.938	1.507	.172	1.594	1.625	1.5000-18UNEF
24	1.575	2.203	.800	1.812	.156	1.062	.703	.328	.755	1.500	.062	.250	2.062	1.634	.172	1.719	1.719	1.6250-18UNEF

All dimensions for reference only.



# Straight Plug

## Military (MS27473), Commercial (JT06, JTS06 & JTN06) (SR)

38999

PART NUMBER BUILDER Page 85-89

**MILITARY**  
MS27473E  
MS27473P  
MS27473T

**Commercial**

**JT06RE, JT06RP, JT06RT**  
**JTS06RE, JTS06RP, JTS06RT**  
**JTN06RE, JTN06RP, JTN06RT**



\* Standard Junior Tri-Lock  
\*\* High temperature version  
\*\*\*Clear iridite finish (gold color), N<sub>2</sub>O<sub>4</sub> resistant

Shell Size	F Dia.	F <sup>1</sup> Dia. +.001 -.025	L Max.	L <sup>1</sup> Max.	L <sup>2</sup> Max.	L <sup>3</sup> Max.	Q Dia. Max.	V Thread Modified		KK Dia. Max.	KK <sup>1</sup> Max.	KK <sup>2</sup> Dia. Max.
								Class 2A UNEF	Modified Major Dia.			
8	.444	.125	1.562	1.000	.938	.891	.734	.4375-28	.421 - .417	.625	.812	.578
10	.558	.188	1.562	1.000	.938	.891	.844	.5625-24	.542 - .538	.750	.875	.703
12	.683	.312	1.562	1.000	.938	.891	1.016	.6875-24	.667 - .663	.875	1.000	.828
14	.808	.375	1.812	1.000	.938	.891	1.141	.8125-20	.791 - .787	1.000	1.125	.953
16	.909	.500	1.812	1.000	.938	.891	1.265	.9375-20	.916 - .912	1.125	1.188	1.078
18	1.034	.625	1.812	1.000	.938	.891	1.391	1.0625-18	1.034 - 1.030	1.250	1.438	1.203
20	1.159	.625	1.812	1.000	.938	.891	1.500	1.1875-18	1.158 - 1.154	1.375	1.438	1.328
22	1.284	.750	1.938	1.000	.938	.891	1.625	1.3125-18	1.283 - 1.279	1.500	1.625	1.453
24	1.409	.800	1.938	1.062	.938	.891	1.750	1.4375-18	1.408 - 1.404	1.625	1.719	1.578

All dimensions for reference only.

# Straight Plug (With Grounding Fingers) - Crimp Military (MS27484), Commercial (JTG06 & JTNG06)

38999

PART NUMBER BUILDER Page 85-89

**MILITARY**  
MS27484E  
MS27484P  
MS27484T

**Commercial**  
JTG06RE, JTG06RP, JTG02RT  
JTNG06RE, JTNG06RP, JTNG06RT

Commercial



- \* Plug with grounding fingers
- \*\* Clear iridite finish (gold color), N2O4 resistant

Shell Size	F Dia.	L Max.	L <sup>1</sup> Max.	Q Dia Max.	V Thread Modified		KK Dia. Max.	KK <sup>1</sup> Dia. Max.
					Class 2A UNEF	Modified Major Dia.		
8	.444	.891	1.000	.734	.4375-28	.421 - .417	.625	.578
10	.558	.891	1.000	.844	.5625-24	.542 - .538	.750	.703
12	.683	.891	1.000	1.016	.6875-24	.667 - .663	.875	.828
14	.808	.891	1.000	1.141	.8125-20	.791 - .787	1.000	.953
16	.909	.891	1.000	1.265	.9375-20	.916 - .912	1.125	1.078
18	1.034	.891	1.000	1.391	1.0625-18	1.034 - 1.030	1.250	1.203
20	1.159	.891	1.000	1.500	1.1875-18	1.158 - 1.154	1.375	1.328
22	1.284	.891	1.000	1.625	1.3125-18	1.283 - 1.279	1.500	1.453
24	1.409	.891	1.062	1.750	1.4375-18	1.408 - 1.404	1.625	1.578

All dimensions for reference only.

B

# 90° Plug - Crimp

## Military (MS27500), Commercial (JT08R, JTS08 & JTN08)

PART NUMBER BUILDER Page 85-89

**MILITARY**  
**MS27500E**

**Commercial**

**JT08RE, JT08RP**  
**JTS08RE, JTS08RP**  
**JTN08RE, JTN08RP**

**Commercial**

- \* JT08RP-XX-XXX
- \*\* JTS08RP-XX-XXX
- \*\*\* JTN08RP-XX-XXX

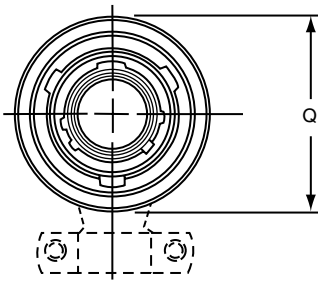

**Commercial**

- \* JT08RE-XX-XXX
- \*\* JTS08RE-XX-XXX
- \*\*\* JTN08RE-XX-XXX

**Military**  
**MS27500E**



- \* Standard Junior Tri-Lock
- \*\* High temperature version
- \*\*\* Clear iridite finish (gold color), N<sub>2</sub>O<sub>4</sub> resistant
- \*\*\*\* Dimensions L and X<sup>1</sup> are applicable when the end of the screw is flush with the surface BB.

Shell Size	H ±.010	K ±.010	L Max.	L <sup>1</sup> Max.	Q Dia. Max.	X Min. Cable	X <sup>1</sup> Max. Cable	FF Max.	FF <sup>1</sup> Max.	KK Max.
8	.547	.156	1.578	1.125	.734	.082	.234	.438	.984	.755
10	.709	.188	1.578	1.156	.844	.082	.234	.516	1.016	.755
12	.829	.281	1.656	1.250	1.016	.114	.328	.594	1.078	.817
14	1.000	.438	1.844	1.406	1.141	.176	.457	.656	1.203	.943
16	1.021	.500	2.000	1.469	1.265	.238	.634	.719	1.265	1.067
18	1.145	.562	2.046	1.531	1.391	.208	.614	.781	1.328	1.149
20	1.270	.625	2.125	1.594	1.500	.302	.608	.844	1.359	1.399
22	1.395	.688	2.250	1.656	1.625	.302	.823	.906	1.421	1.399
24	1.520	.750	2.422	1.797	1.750	.332	.853	.969	1.703	1.587

All dimensions for reference only.

# Wall Mounting Receptacle - Hermetic

## Military (MS27475 & MS27482), Commercial (JT00 & JTS00)

38999

PART NUMBER BUILDER Page 85-89

**MILITARY**  
MS27475Y  
MS27482Y

Commercial

JT00H, JT00Y  
JTS00Y



Commercial

- \* JT00H-XX-XXX
- \*\* JT00Y-XX-XXX
- \*\*\* JTS00Y-XX-XXX

Military

- MS27475YXXDXXX
- MS27482YXXEXXX

Shell Size	L Max.	N +.001 -.005	R (TP)	S ±.016	T ±.005	V Thread Class 2A
8	.234	.473	.594	.812	.120	.5625-24UNEF
10	.234	.590	.719	.938	.120	.6875-24UNEF
12	.234	.750	.812	1.031	.120	.8125-20UNEF
14	.234	.875	.906	1.125	.120	.9375-20UNEF
16	.234	1.000	.969	1.219	.120	1.0625-18UNEF
18	.234	1.125	1.062	1.312	.120	1.1875-18UNEF
20	.234	1.250	1.156	1.438	.120	1.3125-18UNEF
22	.234	1.375	1.250	1.562	.120	1.4375-18UNEF
24	.313	1.500	1.375	1.688	.147	1.5625-18UNEF

- \* Standard Junior Tri-Lock
- \*\* Interfacial seal wafer
- \*\*\* High temperature version, interfacial seal wafer with stainless steel shell

# Box Mounting Receptacle - Hermetic

## Military (MS27476), Commercial (JT02 & JTS02)

PART NUMBER BUILDER Page 85-89

**MILITARY**  
MS27476Y

Commercial

JT02H, JT02Y  
JTS02Y



Commercial

- \* JT02H-XX-XXX
- \*\* JT02Y-XX-XXX
- \*\*\* JTS02Y-XX-XXX

Military

- MS27476YXXDXXX
- MS27476YXXEXXX

Shell Size	L +.006 -.015	N +.001 -.005	R (TP)	S ±.016	T ±.005	KK +.001 -.005
8	.051	.473	.594	.812	.120	.562
10	.051	.590	.719	.938	.120	.672
12	.051	.750	.812	1.031	.120	.781
14	.051	.875	.906	1.125	.120	.906
16	.051	1.000	.969	1.219	.120	1.031
18	.051	1.125	1.062	1.312	.120	1.156
20	.051	1.250	1.156	1.438	.120	1.250
22	.080	1.375	1.250	1.562	.120	1.375
24	.080	1.500	1.375	1.688	.147	1.500

- \* Standard Junior Tri-Lock
- \*\* Interfacial seal wafer
- \*\*\* High temperature version, interfacial seal wafer with stainless steel shell

All dimensions for reference only.

Series II

B

# Jam Nut Receptacle - Hermetic

## Military (MS27477 & MS27483), Commercial (JT07 & JTS07)

PART NUMBER BUILDER Page 85-89

**MILITARY**  
**MS27477Y**  
**MS27483Y**

**Commercial**

**JT07H, JT07Y**  
**JTS07Y**



- \* Standard Junior Tri-Lock
- ★ .059 Dia. Min. 3 lockwire holes. Formed lockwire hole design (6 holes) is optional.
- + "D" shaped mounting hole dimensions.
- \*\* Panel Thickness
- \*\*\* Interfacial seal wafer
- \*\*\*\* High temperature version, interfacial seal wafer with stainless steel shell

**Commercial**  
\* **JT07H-XX-XXX**  
\*\*\* **JT07Y-XX-XX**  
\*\*\*\* **JTS07Y-XX-XXX**

**Military**  
**MS27477YXXDXXX**  
**MS27483YXXEXXX**

Shell Size	A+ +.000 -.010	C Max.	H +.017 -.016	M ±.005	N +.001 -.005	S ±.016	T+ +.010 -.000	Z Max.	RR Thread Class 2A
8	.830	1.390	1.062	.438	.473	1.250	.884	.244	.8750-20UNEF
10	.955	1.515	1.188	.438	.590	1.375	1.007	.244	1.0000-20UNEF
12	1.084	1.640	1.312	.438	.750	1.500	1.134	.244	1.1250-18UNEF
14	1.208	1.765	1.438	.438	.875	1.625	1.259	.244	1.2500-18UNEF
16	1.333	1.953	1.562	.438	1.000	1.781	1.384	.244	1.3750-18UNEF
18	1.459	2.031	1.688	.438	1.125	1.890	1.507	.244	1.5000-18UNEF
20	1.576	2.156	1.812	.464	1.250	2.016	1.634	.218	1.6250-18UNEF
22	1.701	2.280	2.000	.464	1.375	2.140	1.759	.218	1.7500-18UNS
24	1.826	2.405	2.125	.464	1.500	2.265	1.884	.218	1.8750-16UN

# Solder Mounting Receptacle - Hermetic

## Military (MS27478 & MS27503), Commercial (JTI & JTSI)

PART NUMBER BUILDER Page 85-89

**MILITARY**  
**MS27478Y**  
**MS27503Y**

**Commercial**

**JTIH, JTIY**  
**JTSIY**

**Commercial**  
\* **JTIH-XX-XXX**  
\*\* **JTIY-XX-XX**  
\*\*\* **JTSIY-XX-XXX**

**Military**  
**MS27478YXXDXXX**  
**MS27503YXXEXXX**



Shell Size	L +.011 -.010	N +.001 -.005	GG +.011 -.010	KK +.001 -.005
8	.078	.473	.687	.562
10	.078	.590	.797	.672
12	.078	.750	.906	.781
14	.078	.875	1.031	.906
16	.078	1.000	1.156	1.031
18	.078	1.125	1.281	1.156
20	.078	1.250	1.375	1.250
22	.107	1.375	1.500	1.375
24	.107	1.500	1.625	1.500

- \* Standard Junior Tri-Lock
- \*\* Interfacial seal wafer
- \*\*\* High temperature version, interfacial seal wafer with stainless steel shell

All dimensions for reference only. Weld mounting hermetic receptacle also available. Consult Amphenol Aerospace for availability and dimensions.

# Wall Mounting Receptacle - Solder

## Military (MS27334), Commercial (JT00 & JTN00)

38999

PART NUMBER BUILDER Page 85-89

Military qualified to MIL-DTL-27599

**MILITARY**  
MS27334P  
MS27334T

**Commercial**  
JT00A, JT00C, JT00P  
JTN00A, JTN00C, JTN00P

\* Standard Junior Tri-Lock  
NOTE: For availability of back panel mounting types, consult Amphenol Aerospace.



Shell Size	F Dia. Min.	F <sup>1</sup> +.010 - .025	L <sup>1</sup> Max.	L Max.	L <sup>3</sup> Max.	N +.001 - .005	R (TP)	S ±.016	T ±.005	V Thread Modified		KK Dia. Max.	KK <sup>1</sup> Max.
										Size Class 2A	Modified Major Dia.		
8	.312	.125	.422	.734	.234	.473	.594	.812	.120	.4375-28UNEF	.421 - .417	.500	.812
10	.429	.188	.422	.734	.234	.590	.719	.938	.120	.5625-24UNEF	.542 - .538	.625	.875
12	.543	.312	.422	.734	.234	.750	.812	1.031	.120	.6875-24UNEF	.667 - .663	.750	1.000
14	.668	.375	.422	.797	.234	.875	.906	1.125	.120	.8125-20UNEF	.791 - .787	.875	1.125
16	.793	.500	.422	.797	.234	1.000	.969	1.219	.120	.9375-20UNEF	.916 - .912	1.000	1.188
18	.894	.625	.422	.797	.234	1.125	1.062	1.312	.120	1.0625-18UNEF	1.034 - 1.030	1.109	1.438
20	1.019	.625	.422	.859	.234	1.250	1.156	1.438	.120	1.1875-18UNEF	1.158 - 1.154	1.234	1.438
22	1.144	.750	.422	.859	.234	1.375	1.250	1.562	.120	1.3125-18UNEF	1.283 - 1.279	1.359	1.625
24	1.269	.800	.422	.922	.313	1.500	1.375	1.688	.147	1.4375-18UNEF	1.408 - 1.404	1.484	1.719

# Box Mounting Receptacle - Solder

## Military (MS27335), Commercial (JT02 & JTN02)

Military qualified to MIL-DTL-27599

PART NUMBER BUILDER Page 85-89

**MILITARY**  
MS27335T

**Commercial**  
JT02A, JT02C, JT02P  
JTN02A, JTN02C, JTN02P

\* Standard Junior Tri-Lock  
NOTE: For availability of back panel mounting types, consult Amphenol Aerospace.

■ ⊕ .005 DIA ⊗



Shell Size	N +.001 - .005	R (TP)	S ±.016	T ±.005	KK Max.
8	.473	.594	.812	.120	.391
10	.590	.719	.938	.120	.508
12	.750	.812	1.031	.120	.622
14	.875	.906	1.125	.120	.749
16	1.000	.969	1.219	.120	.872
18	1.125	1.062	1.312	.120	.976
20	1.250	1.156	1.438	.120	1.101
22	1.375	1.250	1.562	.120	1.226
24	1.500	1.375	1.688	.147	1.351

All dimensions for reference only.

# Straight Plug - Solder

## Military (MS27336), Commercial (JT06 & JTN06)

Military qualified to MIL-DTL-27599

38999

PART NUMBER BUILDER Page 85-89

**MILITARY**  
MS27336P  
MS27336T

**Commercial**  
JT06A, JT06P  
JTN06A, JTN06P



**Commercial**  
\*JT06P-XX-XXX  
\*JTN06P-XX-XXX

**Military**  
MS27336P

**Commercial**  
\*JT06A-XX-XXX  
\*JTN06A-XX-XXX

**Military**  
MS27336T

**Commercial**  
\*JT06A-XX-XXX(SR)  
\*JTN06A-XX-XXX(SR)

\*Standard Junior Tri-Lock

Shell Size	F Min.	F+.010 -.025	H +.010 -.001	L Max.	LMax.	LMax.	Q Max.	V Thread Modified		KK Max.
								Size Class 2A	Modified Major Dia.	
8	.312	.125	.635	.812	.625	1.109	.734	.4375-28UNEF	.421 - .417	.812
10	.429	.188	.734	.812	.625	1.109	.844	.5625-24UNEF	.542 - .538	.875
12	.543	.312	.870	.812	.625	1.109	1.016	.6875-24UNEF	.667 - .663	1.000
14	.668	.375	.996	.812	.625	1.172	1.141	.8125-20UNEF	.791 - .787	1.125
16	.793	.500	1.122	.828	.625	1.172	1.265	.9375-20UNEF	.916 - .912	1.188
18	.894	.625	1.246	.828	.625	1.172	1.391	1.0625-18UNEF	1.034 - 1.030	1.438
20	1.019	.625	1.372	.828	.625	1.234	1.500	1.1875-18UNEF	1.158 - 1.154	1.438
22	1.144	.750	1.496	.828	.625	1.234	1.625	1.3125-18UNEF	1.283 - 1.279	1.625
24	1.269	.800	1.622	.906	.688	1.297	1.750	1.4375-18UNEF	1.408 - 1.404	1.719

# Straight Plug (With Grounding Ring)

## Commercial (JTG06 & JTNG06)

Military qualified to MIL-DTL-27599

PART NUMBER BUILDER Page 85-89

**Commercial**  
JTG06A  
JTNG06A

**Commercial**  
\*JTG06A-XX-XXX  
\*\*JTNG06A-XX-XXX



- \* Plug with grounding fingers
- \*\* Coupling nut is clear iridite finish (gold color), shell and grounding fingers are gold plated N2O4 resistant.

Shell Size	H Dia. +.010 -.001	L Max.	Q Dia. Max.	V Thread Modified	
				Size Class 2A	Modified Major Dia.
8	.635	.625	.734	.4375-28UNEF	.421 - .417
10	.734	.625	.844	.5625-24UNEF	.542 - .538
12	.870	.625	1.016	.6875-24UNEF	.667 - .663
14	.996	.625	1.141	.8125-20UNEF	.791 - .787
16	1.122	.625	1.265	.9375-20UNEF	.916 - .912
18	1.246	.625	1.391	1.0625-18UNEF	1.034 - 1.030
20	1.372	.625	1.500	1.1875-18UNEF	1.158 - 1.154
22	1.496	.625	1.625	1.3125-18UNEF	1.283 - 1.279
24	1.622	.688	1.750	1.4375-18UNEF	1.408 - 1.404

All dimensions for reference only.

# Jam Mounting Receptacle - Solder

## Military (MS27337), Commercial (JT07 & JTN07)

38999

Military qualified to MIL-DTL-27599

PART NUMBER BUILDER Page 85-89

**MILITARY** JT07A, JT07C, JT07P  
**MS27337P** JTN07A, JTN07C, JTN07P

Commercial



H .059 dia. min. 3 lockwire holes  
 + "D" shaped mounting hole dimensions.  
 \* Standard Junior Tri-Lock  
 \*\* Panel thickness  
 † O Ring not furnished with MS27337

**Commercial**  
 \*JT07P-XX-XXX  
 \*JTN07P-XX-XXX

**Military**  
 MS27337P

**Commercial**  
 \*JT07A-XX-XXX  
 \*JT07C-XX-XXX  
 \*JTN07A-XX-XXX  
 \*JTN07C-XX-XXX

**Commercial**  
 \*JT07A-XX-XXX(SR)  
 \*JTN07A-XX-XXX(SR)  
 \*JTN07C-XX-XXX(SR)

Shell Size	A+ +.000 -.010	C Max.	F Min.	F+.010 -.025	H +.017 -.016	L Max.	M ±.005	N +.001 -.005	S ±.016	T+ +.010 -.000	KK Max.	RR Thread Class 2A
8	.830	1.390	.312	.125	1.062	.666	.438	.473	1.250	.884	.812	.8750-20UNEF
10	.955	1.515	.429	.188	1.188	.666	.438	.590	1.375	1.007	.875	1.0000-20UNEF
12	1.084	1.640	.543	.312	1.312	.666	.438	.750	1.500	1.134	1.000	1.1250-18UNEF
14	1.208	1.765	.668	.375	1.438	.729	.438	.875	1.625	1.259	1.125	1.2500-18UNEF
16	1.333	1.953	.793	.500	1.562	.729	.438	1.000	1.781	1.384	1.188	1.3750-18UNEF
18	1.459	2.031	.894	.625	1.688	.729	.438	1.125	1.890	1.507	1.438	1.5000-18UNEF
20	1.576	2.156	1.019	.625	1.812	.765	.464	1.250	2.016	1.634	1.438	1.6250-18UNEF
22	1.701	2.280	1.144	.750	2.000	.765	.464	1.375	2.140	1.759	1.625	1.7500-18UNS
24	1.826	2.405	1.269	.800	2.125	.828	.464	1.500	2.265	1.884	1.719	1.8750-16UN

# 90° Plug - Solder

## Commercial (JT08 & JTN08)

Military qualified to MIL-DTL-27599

PART NUMBER BUILDER Page 85-89

**Commercial** JT08P  
 JTN08P

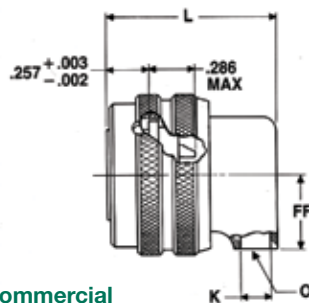
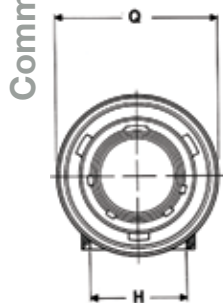

**Commercial**  
 \*JT08P-XX-XXX  
 \*JTN08P-XX-XXX

Shell Size	H Min.	K Min.	L Max.	Q Max.	FF Max.
8	.396	.126	.891	.734	.391
10	.532	.141	.906	.844	.438
12	.694	.173	.938	1.016	.516
14	.814	.266	1.031	1.141	.594
16	.985	.423	1.188	1.265	.656
18	1.006	.485	1.250	1.391	.719
20	1.130	.547	1.312	1.500	.781
22	1.255	.610	1.375	1.625	.844
24	1.380	.673	1.516	1.750	.906

All dimensions for reference only.

B



# PCB Wall Mounting Receptacle Commercial (JTPQ00R)

38999



1. 2. 3. 4. 5.

## PART #

See chart below

1. Shell Finish	2. Base Number	3. Coded Shell Size	4. Insert Arrg.	5. Contact Type/Alt. Keying
88/91	569	731	-35	P

## HOW TO ORDER

### 1. SELECT A SHELL FINISH:

<b>88</b>	Designates olive drab cadmium plated connector shell
<b>91</b>	Designates electroless nickel plated connector shell

Consult Amphenol Aerospace for ordering of composite styles.

### 2. BASE NUMBER:

<b>569</b>	Base Number
------------	-------------

### 3. SELECT A CODED SHELL SIZE:

See chart below **731-739**, designates size 9-25 shell size.

Example: **731** = Size 9 Shell

### 4. SELECT AN INSERT ARRANGEMENT:

Refer to insert availability chart on page 2-5 and pin-out illustrations on pages 14-28.

<b>-35</b>	Designates Insert Arrangement Number
------------	--------------------------------------

### 5. CONTACT TYPE/ALTERNATE KEYING POSITIONS:

Refer to page 89 for alternate rotation letters to use.

<b>P</b>	Designates Pin Contacts in Normal Position
<b>S</b>	Designates Socket Contacts in Normal Position

■  $\oplus$  .005 DIA (M)

Shell Size	Coded Shell Size	N +.001 -.005	P Max. Panel Thickness	R (TP)	S ±.016	T Dia. ±.005	V Thread Class 2A (Plated)	AD Dia. ±.005	SS Dia. +.000 -.016
8	<b>731</b>	.473	.142	.594	.812	.120	.4375-28 UNEF	.516	.563
10	<b>732</b>	.590	.142	.719	.938	.120	.5625-24 UNEF	.633	.680
12	<b>733</b>	.750	.142	.812	1.031	.120	.6875-24 UNEF	.802	.859
14	<b>734</b>	.875	.142	.906	1.125	.120	.8125-20 UNEF	.927	.984
16	<b>735</b>	1.000	.142	.969	1.219	.120	.9375-20 UNEF	1.052	1.108
18	<b>736</b>	1.125	.142	1.062	1.312	.120	1.0625-18 UNEF	1.177	1.233
20	<b>737</b>	1.250	.142	1.156	1.438	.120	1.1875-18 UNEF	1.302	1.358
22	<b>738</b>	1.375	.142	1.250	1.562	.120	1.3125-18 UNEF	1.427	1.483
24	<b>739</b>	1.500	.142	1.375	1.688	.147	1.4375-18 UNEF	1.552	1.610

All dimensions for reference only. Most common options are shown; other options are available.

III

II

I

SJT

Access

Aquacon

Series II

B

# PCB Box Mounting Receptacle (Back Panel Mounting)

## Commercial (JTP02R)

38999

III

II

I

SJT

Access

Aquacon

Series II



	1.	2.	3.	4.	5.
<b>PART #</b>	Shell Finish	Base Number	Coded Shell Size	Insert Arrg.	Contact Type/Alt. Keying
See chart below	88/91	569	74x	-35	P

### HOW TO ORDER

#### 1. SELECT A SHELL FINISH:

<b>88</b>	Designates olive drab cadmium plated connector shell
<b>91</b>	Designates electroless nickel plated connector shell

Consult Amphenol Aerospace for ordering of composite styles.

#### 2. BASE NUMBER:

<b>569</b>	Base Number
------------	-------------

#### 3. SELECT A CODED SHELL SIZE:

See chart below **741-749**, designates size 9-25 shell size.  
Example: **741**= Size 9 Shell

#### 4. SELECT AN INSERT ARRANGEMENT:

Refer to insert availability chart on page 2-5 and pin-out illustrations on pages 14-28.

<b>-35</b>	Designates Insert Arrangement Number
------------	--------------------------------------

#### 5. CONTACT TYPE/ALTERNATE KEYING POSITIONS:

Refer to page 89 for alternate rotation letters to use.

<b>P</b>	Designates Pin Contacts in Normal Position
<b>S</b>	Designates Socket Contacts in Normal Position

■ (+) .005 DIA (M)

Shell Size	Coded Shell Size	L Max.	N +.001 / -.005	P Max. Panel Thickness	R (TP)	S ±.016	T Dia. ±.005	AD Dia. ±.005	KK Dia. Max.
8	<b>741</b>	.225	.473	.147	.594	.812	.120	.516	.531
10	<b>742</b>	.225	.590	.152	.719	.938	.120	.633	.656
12	<b>743</b>	.225	.750	.152	.812	1.031	.120	.802	.828
14	<b>744</b>	.225	.875	.152	.906	1.125	.120	.927	.953
16	<b>745</b>	.225	1.000	.152	.969	1.219	.120	1.052	1.078
18	<b>746</b>	.225	1.125	.152	1.062	1.312	.120	1.177	1.203
20	<b>747</b>	.225	1.250	.179	1.156	1.438	.120	1.302	1.328
22	<b>748</b>	.225	1.375	.179	1.250	1.562	.120	1.427	1.453
24	<b>749</b>	.225	1.500	.169	1.375	1.688	.147	1.552	1.578

All dimensions for reference only. Most common options are shown; other options are available

B

# PCB Jam Nut Receptacle Commercial (JT07)



	1.	2.	3.	4.	5.
<b>PART #</b> See chart below	Shell Finish 88/91	Base Number 569	Coded Shell Size 75*	Insert Arrg. -35	Contact Type/Alt. Keying P

## HOW TO ORDER

### 1. SELECT A SHELL FINISH:

<b>88</b>	Designates olive drab cadmium plated connector shell
<b>91</b>	Designates electroless nickel plated connector shell

Consult Amphenol Aerospace for ordering of composite styles.

### 2. BASE NUMBER:

<b>569</b>	Base Number
------------	-------------

### 3. SELECT A CODED SHELL SIZE:

See chart below **751-759**, designates size 9-25 shell size.  
Example: **751** = Size 9 Shell

### 4. SELECT AN INSERT ARRANGEMENT:

Refer to insert availability chart on page 2-5 and pin-out illustrations on pages 14-28.

<b>-35</b>	Designates Insert Arrangement Number
------------	--------------------------------------

### 5. CONTACT TYPE/ALTERNATE KEYING POSITIONS:

Refer to page 89 for alternate rotation letters to use.

<b>P</b>	Designates Pin Contacts in Normal Position
<b>S</b>	Designates Socket Contacts in Normal Position

Shell Size	Coded Shell Size	A* +.000 -.010	C Max.	H Hex +.017 -.016	L Max.	M ±.005	N +.001 -.005	S ±.016	T* +.010 -.000	V Thread Class 2A (Plated)	RR Thread Class 2A (Plated)
8	<b>751</b>	.830	1.390	1.062	.453	.438	.473	1.250	.884	.4375-28 UNEF	.8750-20 UNEF
10	<b>752</b>	.955	1.515	1.188	.453	.438	.590	1.375	1.007	.5625-24 UNEF	1.0000-20 UNEF
12	<b>753</b>	1.084	1.640	1.312	.453	.438	.750	1.500	1.134	.6875-24 UNEF	1.1250-18 UNEF
14	<b>754</b>	1.208	1.765	1.438	.453	.438	.875	1.625	1.259	.8125-20 UNEF	1.2500-18 UNEF
16	<b>755</b>	1.333	1.953	1.562	.453	.438	1.000	1.781	1.384	.9375-20 UNEF	1.3750-18 UNEF
18	<b>756</b>	1.459	2.031	1.688	.453	.438	1.125	1.890	1.507	1.0625-18 UNEF	1.5000-18 UNEF
20	<b>757</b>	1.576	2.156	1.812	.422	.464	1.250	2.016	1.634	1.1875-18 UNEF	1.6250-18 UNEF
22	<b>758</b>	1.701	2.280	2.000	.422	.464	1.375	2.140	1.759	1.3125-18 UNEF	1.7500-18 UNS
24	<b>759</b>	1.826	2.405	2.125	.422	.464	1.500	2.265	1.884	1.4375-18 UNEF	1.8750-16 UN

All dimensions for reference only.

Most common options are shown; other options are available

★ .059 dia. min. 3 lockwire holes.

Formed lockwire hole design (6 holes) is optional.

\* "D" shaped mounting hole dimensions

# PCB Wall Mounting Receptacle Hermetic Commercial (JT00)

38999

III  
II  
I  
SJT  
Access  
Aquacon

Series II



	1.	2.	3.	4.	5.	6.
<b>PART #</b>	Base Number	Coded Shell Size	Insert Arrg.	Contact Type/ Alt. Keying Position	Shell Finish	Tail Length
See chart below	10-626	431	-35	P	T	B

## HOW TO ORDER

### 1. BASE NUMBER:

**10-626** Base Number for MIL-DTL-38999 Series III Hermetic with PCB Tail

### 2. SELECT A CODED SHELL SIZE:

See chart below **431-439**, designates size 9-25 shell size.

### 3. SELECT AN INSERT ARRANGEMENT:

Refer to insert availability chart on page 2-5 and pin-out illustrations on pages 14-28.

**-35** Designates Insert Arrangement Number

### 4. CONTACT TYPE/ALTERNATE KEYING POSITIONS:

Refer to page 89 for alternate rotation letters to use.

**P** Designates Pin Contacts in Normal Position  
**S** Designates Socket Contacts in Normal Position

### 5. SELECT A SHELL FINISH:

**1** Hermetic seal, passivated Stainless Steel, 200°C  
**2** Hermetic seal, Stainless Steel w/Nickel Plate  
**3** Carbon Steel w/reflowed tin plate

### 6. SELECT A TAIL LENGTH:

**B** .100±.03  
**D** .200±.03  
**F** .300±.03

■ ⊕ .005 DIA (M)

Shell Size	Part Number	L Max.	N +.001 -.005	R (TP)	S ±.016	T ±.005	V Thread Class 2A
8	10-626 <b>431</b> -XXX	.234	.473	.594	.812	.120	.5625-24UNEF
10	<b>432</b> -XXX	.234	.590	.719	.938	.120	.6875-24UNEF
12	<b>433</b> -XXX	.234	.750	.812	1.031	.120	.8125-20UNEF
14	<b>434</b> -XXX	.234	.875	.906	1.125	.120	.9375-20UNEF
16	<b>435</b> -XXX	.234	1.000	.969	1.219	.120	1.0625-18UNEF
18	<b>436</b> -XXX	.234	1.125	1.062	1.312	.120	1.1875-18UNEF
20	<b>437</b> -XXX	.234	1.250	1.156	1.438	.120	1.3125-18UNEF
22	<b>438</b> -XXX	.234	1.375	1.250	1.562	.120	1.4375-18UNEF
24	<b>439</b> -XXX	.313	1.500	1.375	1.688	.147	1.5625-18UNEF

B

# PCB Box Mounting Receptacle Hermetic

## Commercial JT02



PART #	1. Base Number	2. Coded Shell Size	3. Insert Arrg.	4. Contact Type/Alt. Keying Position	5. Shell Finish	6. Tail Length
See chart below	10-626	461	-35	P	1	B

## HOW TO ORDER

### 1. BASE NUMBER:

**10-626** Base Number for MIL-DTL-38999 Series III Hermetic with PCB Tail

### 2. SELECT A CODED SHELL SIZE:

See chart below **461-469**, designates size 9-25 shell size.

### 3. SELECT AN INSERT ARRANGEMENT:

Refer to insert availability chart on page 2-5 and pin-out illustrations on pages 14-28.

**-35** Designates Insert Arrangement Number

### 4. CONTACT TYPE/ALTERNATE KEYING POSITIONS:

Refer to page 89 for alternate rotation letters to use.

**P** Designates Pin Contacts in Normal Position  
**S** Designates Socket Contacts in Normal Position

### 5. SELECT A SHELL FINISH:

**1** Hermetic seal, passivated Stainless Steel, 200°C  
**2** Hermetic seal, Stainless Steel w/Nickel Plate  
**3** Carbon Steel w/reflowed tin plate

### 6. SELECT A TAIL LENGTH:

**B** .100±.03  
**D** .200±.03  
**F** .300±.03

⊕ .005 DIA (M)

Shell Size	Part Number	L +.006 -.015	N +.001 -.005	R (TP)	S ±.016	T ±.005	KK +.001 -.005
8	10-626 <b>461</b> -XXX	.051	.473	.594	.812	.120	.562
10	<b>462</b> -XXX	.051	.590	.719	.938	.120	.672
12	<b>463</b> -XXX	.051	.750	.812	1.031	.120	.781
14	<b>464</b> -XXX	.051	.875	.906	1.125	.120	.906
16	<b>465</b> -XXX	.051	1.000	.969	1.219	.120	1.031
18	<b>466</b> -XXX	.051	1.125	1.062	1.312	.120	1.156
20	<b>467</b> -XXX	.051	1.250	1.156	1.438	.120	1.250
22	<b>468</b> -XXX	.080	1.375	1.250	1.562	.120	1.375
24	<b>469</b> -XXX	.080	1.500	1.375	1.688	.147	1.500

All dimensions for reference only.

# PCB Jam Nut Receptacle Hermetic Commercial (JT07)

38999

III  
II  
I  
SJT  
Access  
Aquacon

Series II



	1.	2.	3.	4.	5.	6.
<b>PART #</b>	Base Number	Coded Shell Size	Insert Arrg.	Contact Type/ Alt. Keying Position	Shell Finish	Tail Length
See chart below	10-626	441	-35	P	1	B

## HOW TO ORDER

### 1. BASE NUMBER:

**10-626** Base Number for MIL-DTL-38999 Series III Hermetic with PCB Tail

### 2. SELECT A CODED SHELL SIZE:

See chart below **441-449**, designates size 9-25 shell size.

### 3. SELECT AN INSERT ARRANGEMENT:

Refer to insert availability chart on page 2-5 and pin-out illustrations on pages 14-28.

**-35** Designates Insert Arrangement Number

### 4. CONTACT TYPE/ALTERNATE KEYING POSITIONS:

Refer to page 89 for alternate rotation letters to use.

- P** Designates Pin Contacts in Normal Position
- S** Designates Socket Contacts in Normal Position

### 5. SELECT A SHELL FINISH:

- 1** Hermetic seal, passivated Stainless Steel, 200°C
- 2** Hermetic seal, Stainless Steel w/Nickel Plate
- 3** Carbon Steel w/reflowed tin plate

### 6. SELECT A TAIL LENGTH:

- B** .100±.03
- D** .200±.03
- F** .300±.03

Shell Size	Part Number	A+ +.000 -.010	C Max.	H +.017 -.016	M ±.005	N +.001 -.005	S ±.016	T+ +.010 -.000	RR Thread Class 2A
8	10-626 <b>441</b> -XXX	.830	1.390	1.062	.438	.473	1.250	.884	.8750-20UNEF
10	<b>442</b> -XXX	.955	1.515	1.188	.438	.590	1.375	1.007	1.0000-20UNEF
12	<b>443</b> -XXX	1.084	1.640	1.312	.438	.750	1.500	1.134	1.1250-18UNEF
14	<b>444</b> -XXX	1.208	1.765	1.438	.438	.875	1.625	1.259	1.2500-18UNEF
16	<b>445</b> -XXX	1.333	1.953	1.562	.438	1.000	1.781	1.384	1.3750-18UNEF
18	<b>446</b> -XXX	1.459	2.031	1.688	.438	1.125	1.890	1.507	1.5000-18UNEF
20	<b>447</b> -XXX	1.576	2.156	1.812	.464	1.250	2.016	1.634	1.6250-18UNEF
22	<b>448</b> -XXX	1.701	2.280	2.000	.464	1.375	2.140	1.759	1.7500-18UNS
24	<b>449</b> -XXX	1.826	2.405	2.125	.464	1.500	2.265	1.884	1.8750-16UN

★ .059 Dia. Min. 3 lockwire holes. Formed lockwire hole design (6 holes) is optional.

+ "D" shaped mounting hole dimensions.

\*\* Panel Thickness

All dimensions for reference only.

B

# PCB Solder Mounting Receptacle Hermetic Commercial (JTI)

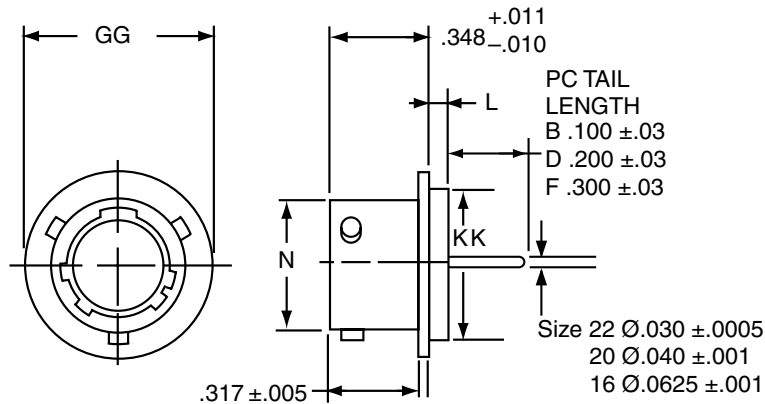

PART #	1. Base Number	2. Coded Shell Size	3. Insert Arrg.	4. Contact Type/ Alt. Keying Position	5. Shell Finish	6. Tail Length
See chart below	10-626	451	-35	P	1	B

## HOW TO ORDER

### 1. BASE NUMBER:

<b>10-626</b>	Base Number for MIL-DTL-38999 Series III Hermetic with PCB Tail
---------------	---

### 2. SELECT A CODED SHELL SIZE:

See chart below **451-459**, designates size 9-25 shell size.

### 3. SELECT AN INSERT ARRANGEMENT:

Refer to insert availability chart on page 2-5 and pin-out illustrations on pages 14-28.

<b>-35</b>	Designates Insert Arrangement Number
------------	--------------------------------------

### 4. CONTACT TYPE/KEYING POSITIONS:

Refer to page 89 for alternate rotation letters to use.

<b>P</b>	Designates Pin Contacts in Normal Position
<b>S</b>	Designates Socket Contacts in Normal Position

### 5. SELECT A SHELL FINISH:

<b>1</b>	Hermetic seal, passivated Stainless Steel, 200°C
<b>2</b>	Hermetic seal, Stainless Steel w/Nickel Plate
<b>3</b>	Carbon Steel w/reflowed tin plate

### 6. SELECT A TAIL LENGTH:

<b>B</b>	.100±.03
<b>D</b>	.200±.03
<b>F</b>	.300±.03

Shell Size	Part Number	L +.011 -.010	N +.001 -.005	GG +.011 -.010	KK +.001 -.005
8	10-626 <b>451</b> -XXX	.078	.473	.687	.562
10	<b>452</b> -XXX	.078	.590	.797	.672
12	<b>453</b> -XXX	.078	.750	.906	.781
14	<b>454</b> -XXX	.078	.875	1.031	.906
16	<b>455</b> -XXX	.078	1.000	1.156	1.031
18	<b>456</b> -XXX	.078	1.125	1.281	1.156
20	<b>457</b> -XXX	.078	1.250	1.375	1.250
22	<b>458</b> -XXX	.107	1.375	1.500	1.375
24	<b>459</b> -XXX	.107	1.500	1.625	1.500

All dimensions for reference only.  
Weld mounting hermetic receptacle also available.  
Consult Amphenol Aerospace for availability and dimensions.

# MIL-DTL-38999/ 27599, Series I LJT

# C



## TABLE OF CONTENTS FOR SECTION C

Combined MIL-DTL-38999 Series I, II, III

Shell Size & Insert Arrangement Availability . . . . .	2-5
Insert Arrangement Drawings . . . . .	10-17
Contact -Ratings, Service Ratings, Finish Data . . . . .	18, 19
Sealing Plugs . . . . .	19
MIL-DTL-38999, Series II JT and Series I LJT	
Features and Benefits . . . . .	82-83
How to Order (Military) . . . . .	113-114
How to Order (Commercial) . . . . .	115-117

### LJT SHELL STYLES:

Crimp Wall Mounting Receptacle LJT00R (MS27466) . . . . .	118
Crimp Wall Mount Recept. for Back Panel Mounting LJTPQ00R (MS27656) . . . . .	119
Crimp Line Receptacle LJT01R . . . . .	120
Crimp Box Mounting Receptacle LJT02R (MS27496), Crimp Box Mounting Receptacle for Back Panel Mounting LJTP02R (MS27505) . . . . .	121
Crimp Jam Nut Receptacle LJT07R (MS27468) . . . . .	122
Crimp Straight Plug LJT06R (MS27467) . . . . .	123

### HERMETIC:

Hermetic Wall Mounting Receptacle LJT00 (MS27469) . . . . .	124
Hermetic Jam Nut Receptacle LJT07 (MS27470) . . . . .	125
Hermetic Solder Mounting Receptacle LJTL (MS27471) . . . . .	126
Solder Wall Mounting Receptacle LJT00 (MS20026) . . . . .	127
Solder Line Receptacle LJT01 (MS20027) . . . . .	128
Solder Straight Plug LJT06 (MS20028) . . . . .	129
Solder Jam Nut Receptacle LJT07 (MS20029) . . . . .	130

### PCB Shell:

PCB Wall Mounting Receptacle, Back Panel Mounting . . . . .	131
PCB Wall Mounting Receptacle, Back Panel Mounting, Clinch Nuts . . . . .	132
PCB Box Mounting Receptacle, Back Panel Mounting . . . . .	133
PCB Box Mounting Receptacle, Back Panel Mounting, Clinch Nuts . . . . .	134
PCB Jam Nut Receptacle (LJT07) . . . . .	135
PCB Hermetic Wall Mounting Receptacle (LJT00) . . . . .	136
PCB Hermetic Jam Nut Receptacle . . . . .	137
PCB Solder Mounting Receptacle (LJTI) . . . . .	138

### BREAKAWAY:

Breakaway Fail-Safe How to Order (Military /Commercial) . . . . .	139
Breakaway Fail-Safe Insert Availability Chart . . . . .	140
Breakaway Fail-Safe Overview/Information. . . . .	141

### ACCESSORIES:

Section F . . . . .	164-183
---------------------	---------

# C



# Military to Commercial Shell Style Conversion Table

## How to Order (Military)

38999

III  
II  
I  
SJT  
Access  
Aquacon

Series I

MILITARY	DESCRIPTION	COMMERCIAL
<b>MS27466</b>	Crimp Wall Mounting Receptacle	<b>LJT00</b>
<b>MS27656</b>	Crimp Wall Mounting Receptacle (Back Panel)	<b>LJTPQ00</b>
<b>MS27496</b>	Crimp Box Mounting Receptacle	<b>LJT02, LJTP02</b>
<b>MS27505</b>	Crimp Box Mounting Receptacle (Back Panel)	<b>LJTP02</b>
<b>MS27467</b>	Crimp Straight Plug	<b>LJT06</b>
<b>MS27468</b>	Crimp Jam Nut Receptacle	<b>LJT07</b>
<b>MS27469</b>	Hermetic Wall Mounting Receptacle	<b>LJT00, LJTS00</b>
<b>MS27470</b>	Hermetic Jam Nut Receptacle	<b>LJT07, LJTS07</b>
<b>MS27471</b>	Hermetic Solder Mounting Receptacle	<b>LJTIH, LJTIY, LJTSIY</b>
<b>MIL-DTL-27599</b>		
<b>MS20026</b>	Solder Wall Mounting Receptacle	<b>LJT00</b>
<b>MS20027</b>	Solder Line Receptacle	<b>LJT01</b>
<b>MS20028</b>	Solder Straight Plug	<b>LJT06</b>
<b>MS20029</b>	Solder Jam Mounting Receptacle	<b>LJT07</b>

## HOW TO ORDER - MILITARY SERIES I

1. MS Number	2. Service Class	3. Shell Size	4. Finishes	5. Insert Arrangement	6. Contact Style (P or S)	7. Alternate Keying Position
<b>MS27466</b>	<b>E</b>	<b>14</b>	<b>A</b>	<b>18</b>	<b>P</b>	<b>A</b>

1. MS NUMBER SERIES I LJT		2. SERVICE CLASS				
		CRIMP		SOLDER		
<b>MS27466</b>	Crimp Wall Mounting Receptacle	<b>WALL MOUNT (466)</b>	<b>BOX MOUNT (496)</b>	<b>WALL MOUNT (026)</b>	<b>JAM NUT (029)</b>	
<b>MS27656</b>	Crimp Wall Mounting Receptacle (Back Panel Mounting)	<b>WALL MOUNT BPM (656)</b>	<b>BOX MOUNT BPM (505)</b>	<b>LINE (027)</b>		
<b>MS27496</b>	Crimp Box Mounting Receptacle	<b>STRAIGHT PLUG (467)</b>		<b>STRAIGHT PLUG (028)</b>		
<b>MS27505</b>	Crimp Box Mounting Receptacle (Back Panel Mounting)	<b>JAM NUT (468)</b>				
<b>MS27467</b>	Crimp Straight Plug	<b>E</b>	<b>E</b>			Environmental crimp applications. Box Mount versions using spacer grommets are not environmental.
<b>MS27468</b>	Crimp Jam Nut Receptacle	<b>P</b>			<b>P</b>	Potting crimp applications. Supplied with spacer grommet and potting boot.
<b>MS27469</b>	Hermetic Wall Mounting Receptacle					Environmental applications. Supplied without rear accessories. Design provides serrations on rear threads of shells.
<b>MS27470</b>	Hermetic Jam Nut Receptacle	<b>T</b>		<b>T</b>		
<b>MS27471</b>	Hermetic Solder Mounting Receptacle					
<b>MIL-DTL-27599</b>						
<b>MS20026</b>	Solder Wall Mounting Receptacle					
<b>MS20027</b>	Solder Line Receptacle					
<b>MS20028</b>	Solder Straight Plug					
<b>MS20029</b>	Solder Jam Nut Receptacle					
2. HERMETIC SERVICE CLASS						
<b>WALL MOUNT (469)</b>						
<b>JAM NUT (470)</b>						
<b>SOLDER MOUNT (471)</b>						
<b>Y</b>	Hermetically interfacial seal					



# MIL-DTL-38999/ 27599, Series I LJT

## How to Order (Military)

38999

1.	2.	3.	4.	5.	6.	7.
MS Number	Service Class	Shell Size	Finishes	Insert Arrangement	Contact Style (P or S)	Alternate Keying Position
<b>MS27466</b>	<b>E</b>	<b>15</b>	<b>A</b>	<b>18</b>	<b>P</b>	<b>A</b>

### 3. SHELL SIZE

See table on page 2-5

Shell Size & Insert Arrangement are on pages 2-5. First number represents Shell Size, second number is the Insert Arrangement. Place Shell Size in box 3 and Insert Arrangement in box 5.

### 4. FINISHES

Finish	Military Finish Data
Cadmium plated nickel base 175°C	<b>A</b>
Olive drab cadmium plate nickel base 175°C	<b>B</b>
Electroless nickel 200°C	<b>F</b>
Electroless nickel, space compatible 200°C	
Anodic coating (Alumilite) 200°C	<b>C</b>
Chromate treated (Iridite 14-2) 125°C	
Passivated steel 200°C	<b>E</b>
Nickel-PTFE 175°C	

### 4. HERMETIC FINISHES

Finish	Military Finish Data
Carbon steel shell tin plated & contacts	<b>D</b>
Stainless steel shell passivated	<b>N</b>
Stainless steel nickel plated	<b>N</b>

### 5. INSERT ARRANGEMENT

See table on page 2-5

### 6. CONTACTS

<b>P</b>	Pin Contacts
<b>S</b>	Socket Contacts

### 7. ALTERNATE KEYING POSITION

"A" designates Alternate keying connector assembly. Other basic alternate keys are "B", "C" and "D". No letter required for normal rotation (no rotation) position.

A plug with a given rotation letter will mate with a receptacle with the same rotation letter. The AB angle for a given connector is the same whether it contains pins or sockets. Only the master key/keyway rotates in the shell, and the minor keys are fixed. AB angles shown are viewed from the front face of the connector, a receptacle is shown below. The angles for the plug are exactly the same except the direction of rotation is opposite of that shown for the receptacle.

The "N" designation is not referenced in part number, it is omitted.



RELATIVE POSSIBLE POSITION OF ROTATED MASTER KEYWAY (front face of receptacle shown)

### LJT Key/Keyway Rotation

AB ANGLE OF ROTATION (Degrees)					
Shell Size	Normal	A	B	C	D
9	95°	77°	-	-	113°
11	95°	81°	67°	123°	109°
13	95°	75°	63°	127°	115°
15	95°	74°	61°	129°	116°
17	95°	77°	65°	125°	113°
19	95°	77°	65°	125°	113°
21	95°	77°	65°	125°	113°
23	95°	80°	69°	121°	110°
25	95°	80°	69°	121°	110°

## How to Order (Commercial)

38999

1.	2.	3.	4.	5.	6.
Table & Style	Service Class	Shell Size -Insert Arrg.	Contact Style (P or S)	Alternate Keying Position	Strain Relief/Finish Variation Suffix**
<b>LJT00</b>	<b>RT</b>	<b>9-35</b>	<b>P</b>	<b>B</b>	<b>(014)</b>

\*\* If Required

III

II

I

SJT

Access

Aquacon

Series I

CONNECTOR TYPE & STYLE

		SERIES I		
		Long Junior Tri-Lock	High Temperature	Chemical and Fuel Resistant
Receptacle Crimp	Wall Mounting Receptacle	LJT00	LJTS00	LJTN00
	Box Mounting Receptacle	LJT02	LJTS02	LJTN02
	Line Receptacle	LJT01	LJTS01	LJTN01
	Jam Nut Receptacle	LJT07	LJTS07	LJTN07
	Wall Mounting Receptacle (Back Panel)	LJTPQ00	LJTPS00	LJTPN00
	Box Mounting Receptacle (Back Panel)	LJTP02	LJTPS02	LJTPN02

Plugs	Straight Plug	LJT06	LJTS06	LJTN06
-------	---------------	-------	--------	--------

Printed Circuit Board	Wall Mounting Receptacle	See page 130 for part number order guide		
	Wall Mounting Receptacle (Back Panel)	See page 131 for part number order guide		
	Wall Mounting Receptacle (Back Panel) (Clinch Nut)	See page 132 for part number order guide		
	Box Mounting Receptacle (Back Panel)	See page 133 for part number order guide		
	Box Mounting Receptacle (Back Panel) (Clinch Nut)	See page 134 for part number order guide		
	Jam Nut Receptacle	See page 135 for part number order guide		
	Jam Nut Receptacle	See page 136 for part number order guide		
	Jam Nut Receptacle (Hermetic)	See page 137 for part number order guide		
Solder Mounting Receptacle (Hermetic)	See page 138 for part number order guide			

Hermetic	Wall Mounting Receptacle	LJT00	LJTS00	LJTN00
	Jam Nut Receptacle	LJT07	LJTS07	LJTN07
	Solder Mounting Receptacle	LJTI	LJTSI	LJTNI

Wall Mounting Receptacle



Line Receptacle



Jam Nut Receptacle



Straight Plug



Solder Mounting Receptacle



Lanyard Release Plug



# MIL-DTL-38999/ 27599, Series I LJT

## How to Order (Commercial)

38999

### 2. SERVICE CLASS

CRIMP		
WALL MOUNT	Box Mount	Crimp Contacts/ Connectors
PLUG		
LINE		
JAM NUT		
<b>RP</b>		Potting crimp applications. Supplied with spacer grommet and potting boot.††
<b>RE</b>	<b>RE</b>	Environmental crimp applications. Supplied with a grommet and compression nut. Can be supplied with strain relief integral with compression nut "RE(SR)".
<b>RT</b>		Environmental applications. Supplied without rear accessories. Design provides serrations on rear threads of shells.
SOLDER		
WALL MOUNT		Solder Contacts/ Connectors
LINE		
STRAIGHT PLUG		
JAM NUT		
<b>P</b>		Potting applications: These connectors are supplied with a potting boot. All shells are designed with integral features to retain potting boots.
<b>C</b>		Pressurized applications
<b>T</b>		MIL-DTL-27599 applications-general duty, pressurized (receptacle only) (LJT only molded in solder type contacts) Not applicable with Box Mount Styles
HERMETIC		
WALL MOUNT		
JAM NUT		
SOLDER MOUNTING RECEPTACLE		
<b>Y</b>		Same as "H" with interfacial seal.
<b>H</b>		Hermetic applications- Fused compression glass sealed inserts. Leakage rate less than .01 micron cu. ft./hr. (1 x 10 <sup>-7</sup> cc/sec.) at 15 psi differential.

### 3. SHELL SIZE & INSERT ARRANGEMENT SEE PAGE 2-5

First number represents Shell Size,  
second number is the Insert Arrangement.

4. CONTACTS	
<b>P</b>	Pin Contacts
<b>S</b>	Socket Contacts

**How to Order (Commercial)**

38999

- III
- II
- I**
- SJT
- Access
- Aquacon

**5. ALTERNATE KEYING POSITION**

“A” designates Alternate keying connector assembly. Other basic alternate keys are “B”, “C” and “D”. No letter required for normal rotation (no rotation) position.



RELATIVE POSSIBLE POSITION OF ROTATED MASTER KEYWAY (front face of receptacle shown)

A plug with a given rotation letter will mate with a receptacle with the same rotation letter. The AB angle for a given connector is the same whether it contains pins or sockets. Only the master key/keyway rotates in the shell, and the minor keys are fixed.

AB angles shown are viewed from the front face of the connector, a receptacle is shown below. The angles for the plug are exactly the same except the direction of rotation is opposite of that shown for the receptacle.

The “N” designation is not referenced in part number, it is omitted.

**LJT Key/Keyway Rotation**

AB ANGLE OF ROTATION (Degrees)					
Shell Size	Normal	A	B	C	D
9	95°	77°	-	-	113°
11	95°	81°	67°	123°	109°
13	95°	75°	63°	127°	115°
15	95°	74°	61°	129°	116°
17	95°	77°	65°	125°	113°
19	95°	77°	65°	125°	113°
21	95°	77°	65°	125°	113°
23	95°	80°	69°	121°	110°
25	95°	80°	69°	121°	110°

**6. SELECT A STRAIN RELIEF OPTION OR FINISH VARIATION SUFFIX**

Strain Relief Options: “SR” designates a strain relief clamp. Strain reliefs are available only on Service Class “C” and “RE” (see step 3. Service Class)

Finish Variation Suffix: See finish variations available in table to your right.

**6. HERMETIC FINISHES**

Finish	Finish Suffix
Carbon steel shell tin plated & contacts	<b>(468)</b>
Stainless steel shell pas-sivated	<b>(162)</b>
Stainless steel nickel plated	<b>0</b>

**6. FINISHES**

Finish	Finish Suffix	Finish Plus “SR” Suffix
		<b>Class RE and C Only</b>
Cadmium plated nickel base 175°C		<b>(SR)</b>
Olive drab cadmium plate nickel base 175°C	<b>(014)</b>	<b>(386)</b>
Electroless nickel 200°C	<b>(023)</b>	<b>(424)</b>
Electroless nickel, space compatible 200°C	<b>(453)</b>	<b>(467)</b>
Anodic coating (Alumilite) 200°C	<b>(005)</b>	<b>(300)</b>
Chromate treated (Iridite 14-2) 125°C	<b>(011)</b>	<b>(344)</b>
Passivated steel 200°C	-	-
Nickel-PTFE 175°C	<b>(045)</b>	<b>(582)</b>
Zinc-Nickel Plated 175°C	<b>(033)</b>	

Series I

C

# Wall Mounting Receptacle - Crimp

**Military (MS27466), Commercial (LJT00R)**

38999

PART NUMBER BUILDER Page 113-117

**MILITARY**  
**MS27466E**  
**MS27466P**  
**MS27466T**

**Commercial**  
**LJT00RE**  
**LJT00RP**  
**LJT00RT**



**Commercial**  
**LJT00RE-XX-XXX**  
**LJT00RT-XX-XXX**

**Military**  
**MS27466E**  
**MS27466T**



**Commercial**  
**LJT00RP-XX-XXX**

**Military**  
**MS27466P**

■ ⊕ .005 DIA ⊕

Shell Size	F Dia. ±.010	L Max.	M +.000 - .005	N +.001 - .005	R (TP)	S ±.016	T Dia. ±.005	V Thread Class 2A (Plated)	KK Dia. Max
9	.444	.813	.632	.572	.719	.938	.128	.4375-28 UNEF	.608
11	.558	.813	.632	.700	.812	1.031	.128	.5625-24 UNEF	.734
13	.683	.813	.632	.850	.906	1.125	.128	.6875-24 UNEF	.858
15	.808	.813	.632	.975	.969	1.219	.128	.8125-20 UNEF	.984
17	.909	.813	.632	1.100	1.062	1.312	.128	.9375-20 UNEF	1.110
19	1.034	.813	.632	1.207	1.156	1.438	.128	1.0625-18 UNEF	1.234
21	1.159	.906	.602	1.332	1.250	1.562	.128	1.1875-18 UNEF	1.360
23	1.284	.906	.602	1.457	1.375	1.688	.147	1.3125-18 UNEF	1.484
25	1.409	.906	.602	1.582	1.500	1.812	.147	1.4375-18 UNEF	1.610

All dimensions for reference only.

# Wall Mounting Receptacle (Back Panel Mounting)

**Military (MS27656), Commercial (LJTPQ00R)**

38999

PART NUMBER BUILDER Page 113-117

**MILITARY**  
MS27656E  
MS27656P  
MS27656T

**Commercial**  
LJTQ00RE  
LJTPQ00RP  
LJTPQ00RT



**Commercial**  
LJTPQ00RE-XX-XXX  
LJTPQ00RT-XX-XXX

**Military**  
MS27656E  
MS27656T



**Commercial**  
LJTPQ00RP-XX-XXX

**Military**  
MS27656P

■  $\oplus$  .005 DIA  $\text{\textcircled{M}}$

Shell Size	F Dia. $\pm .010$	L Max.	L' Max.	M $^{+.000}_{-.005}$	N Dia.	P Max. Panel Thickness	R (TP)	S $^{+.011}_{-.010}$	T Dia. $\pm .005$	V Thread Class 2A (Plated)	Z Max	KK Dia. Max	SS Dia. $^{+.000}_{-.016}$
9	.444	.453	.641	.820	.572	.234	.719	.938	.128	.4375-28 UNEF	.138	.625	.662
11	.558	.453	.641	.820	.700	.234	.812	1.031	.128	.5625-24 UNEF	.138	.750	.810
13	.683	.453	.641	.820	.850	.234	.906	1.125	.128	.6875-24 UNEF	.138	.875	.960
15	.808	.453	.641	.820	.975	.234	.969	1.219	.128	.8125-20 UNEF	.138	1.000	1.085
17	.909	.453	.641	.820	1.100	.234	1.062	1.312	.128	.9375-20 UNEF	.138	1.125	1.210
19	1.034	.453	.641	.820	1.207	.234	1.156	1.438	.128	1.0625-18 UNEF	.138	1.250	1.317
21	1.159	.484	.672	.790	1.332	.204	1.250	1.562	.128	1.1875-18 UNEF	.168	1.375	1.442
23	1.284	.484	.672	.790	1.457	.204	1.375	1.688	.147	1.3125-18 UNEF	.168	1.500	1.567
25	1.409	.484	.672	.790	1.582	.193	1.500	1.812	.147	1.4375-18 UNEF	.168	1.625	1.692

All dimensions for reference only.  
Note: MS27656 superseded MS 27515.

# Line Receptacle - Crimp

## Commercial (LJT01R)

38999

PART NUMBER BUILDER Page 113-117

Commercial  
**LJT01RE**  
**LJT01RT**  
**LJT01RP**

Series I

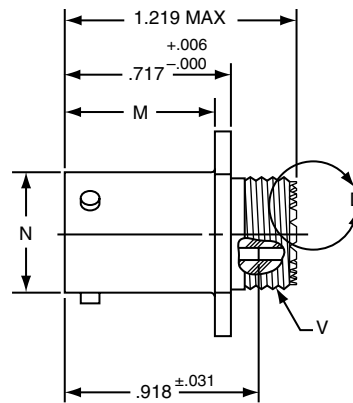

Commercial  
**LJT01RE-XX-XXX**  
**LJT01RT-XX-XXX**  
**LJT01RP-XX-XXX**

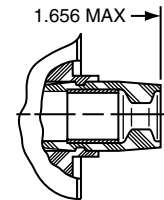

VIEW D ENLARGED  
 FOR COAXIAL USE ONLY

Shell Size	C Max.	M +.000 -.005	N +.001 -.005	S ±.016	V Thread Class 2A (Plated)
9	1.094	.632	.572	.938	.4375-28 UNEF
11	1.188	.632	.700	1.031	.5625-24 UNEF
13	1.281	.632	.850	1.125	.6875-24 UNEF
15	1.375	.632	.975	1.219	.8125-20 UNEF
17	1.469	.632	1.100	1.312	.9375-20 UNEF
19	1.594	.632	1.207	1.438	1.0625-18 UNEF
21	1.719	.602	1.332	1.562	1.1875-18 UNEF
23	1.844	.602	1.457	1.688	1.3125-18 UNEF
25	1.969	.602	1.582	1.812	1.4375-18 UNEF

All dimensions for reference only.



# Box Mounting Receptacle (Back Panel Mounting)

## Military (MS27496 & MS27505), Commercial (LJT02R & LJTP02R)

PART NUMBER BUILDER Page 113-117

**MILITARY** LJT02RE  
MS27496E LJTP02RE (Back Panel Mounting)  
MS27505E

Commercial



**Commercial**  
LJT02RE-XX-XXX

**Military**  
MS27496E



**Commercial**  
LJTP02RE-XX-XXX

**Military**  
MS27505E

⊕ .005 DIA M

Shell Size	L Max.	M +.000 -.005	M' +.001 -.005	N Dia +.001 -.005	P Max. Panel Thickness	R (TP)	S +.011 -.010	T Dia. ±.005	Z ±.031	KK Dia. +.006 -.005	SS Dia. +.000 -.016
9	.203	.632	.820	.572	.234	.719	.938	.128	.107	.433	.662
11	.203	.632	.820	.700	.234	.812	1.031	.128	.107	.557	.810
13	.203	.632	.820	.850	.234	.906	1.125	.128	.107	.676	.960
15	.203	.632	.820	.975	.234	.969	1.219	.128	.107	.801	1.085
17	.203	.632	.820	1.100	.234	1.062	1.312	.128	.107	.926	1.210
19	.203	.632	.820	1.207	.234	1.156	1.438	.128	.107	1.032	1.317
21	.234	.602	.790	1.332	.204	1.250	1.562	.128	.137	1.157	1.442
23	.234	.602	.790	1.457	.204	1.375	1.688	.147	.137	1.282	1.567
25	.234	.602	.790	1.582	.193	1.500	1.812	.147	.137	1.407	1.692

All dimensions for reference only.

# Jam Nut Receptacle - Crimp

## Military (MS27468), Commercial (LJT07R)

38999

PART NUMBER BUILDER Page 113-117

**MILITARY** LJT07RE, LJT07RP, LJT07RT  
**MS27468E**  
**MS27468P**  
**MS27468T**

Commercial



VIEW D ENLARGED FOR COAXIAL USE ONLY

**Commercial**  
**LJT07RE-XX-XXX**  
**LJT07RT-XX-XXX**

**Military**  
**MS27468E**  
**MS27468T**



**Commercial**  
**LJT07RP-XX-XXX**

**Military**  
**MS27468P**

- ★ .059 Dia. Min. 3 lockwire holes.  
Formed lockwire hole design (6 holes) is optional.
- + "D" shaped mounting hole dimensions.

Shell Size	A+ +.000 -.010	C Max.	F Dia. ±.010	H Hex +.017 -.016	L Max.	N +.001 -.005	S ±.016	T+ +.010 -.000	V Thread Class 2A (Plated)	KK Dia. Max.	RR Thread Class 2A (Plated)
9	.669	1.199	.444	.875	.625	.572	1.062	.697	.4375-28 UNEF	.608	.6875-24 UNEF
11	.769	1.386	.558	1.000	.625	.700	1.250	.822	.5625-24 UNEF	.734	.8125-20 UNEF
13	.955	1.511	.683	1.188	.625	.850	1.375	1.007	.6875-24 UNEF	.858	1.0000-20 UNEF
15	1.084	1.636	.808	1.312	.625	.975	1.500	1.134	.8125-20 UNEF	.984	1.1250-18 UNEF
17	1.208	1.761	.909	1.438	.625	1.100	1.625	1.259	.9375-20 UNEF	1.110	1.2500-18 UNEF
19	1.333	1.949	1.034	1.562	.656	1.207	1.812	1.384	1.0625-18 UNEF	1.234	1.3750-18 UNEF
21	1.459	2.073	1.159	1.688	.750	1.332	1.938	1.507	1.1875-18 UNEF	1.360	1.5000-18 UNEF
23	1.580	2.199	1.284	1.812	.750	1.457	2.062	1.634	1.3125-18 UNEF	1.484	1.6250-18 UNEF
25	1.709	2.323	1.409	2.000	.750	1.582	2.188	1.759	1.4375-18 UNEF	1.610	1.7500-18 UNS

All dimensions for reference only.

# Straight Plug - Crimp

## Military (MS27467), Commercial (LJT06R)

PART NUMBER BUILDER Page 113-117

**MILITARY**  
MS27467E  
MS27467P  
MS27467T

Commercial

LJT06RE, LJT02RP, LJT02RT



Shell Size	F Dia. ±.010	L Max.	Q Max.	V Thread Class 2A (Plated)	KK Dia. Max.
9	.444	1.531	.844	.4375-28 UNEF	.608
11	.528	1.531	.969	.5625-24 UNEF	.734
13	.683	1.531	1.141	.6875-24 UNEF	.858
15	.808	1.531	1.266	.8125-20 UNEF	.984
17	.909	1.531	1.391	.9375-20 UNEF	1.110
19	1.034	1.531	1.500	1.0625-18 UNEF	1.234
21	1.159	1.625	1.625	1.1875-18 UNEF	1.360
23	1.284	1.625	1.750	1.3125-18 UNEF	1.484
25	1.409	1.625	1.875	1.4375-18 UNEF	1.610

All dimensions for reference only.

# Wall Mounting Receptacle - Hermetic

**Military (MS27469), Commercial (LJT00)**

38999

PART NUMBER BUILDER Page 113-117

**MILITARY**  
**MS27469Y**

**Commercial**

**LJT00H, LJT00Y**  
**LJTS00Y**



**Commercial**

- \* LJT00H-XX-XXX
- \*\* LJT00Y-XX-XXX
- \*\*\* LJTS00Y-XX-XXX

**Military**

- MS27469YXXD
- MS27469YXXE

■  $\text{⊕}$  .005 DIA  $\text{Ⓜ}$

- \* Long Junior Tri-Lock
- \*\* Interfacial seal wafer
- \*\*\* High temperature version, interfacial seal wafer with stainless steel shell

Shell Size	N Dia. +.001 -.005	R (TP)	S ±.016	T Dia. ±.005	RR Thread Class 2A
9	.572	.719	.938	.128	.6875-24 UNEF
11	.700	.812	1.031	.128	.8125-20 UNEF
13	.850	.906	1.125	.128	.9375-20 UNEF
15	.975	.969	1.219	.128	1.0625-18 UNEF
17	1.100	1.062	1.312	.128	1.1875-18 UNEF
19	1.207	1.156	1.438	.128	1.3125-18 UNEF
21	1.332	1.250	1.562	.128	1.4375-18 UNEF
23	1.457	1.375	1.688	.147	1.5625-18 UNEF
25	1.582	1.500	1.812	.147	1.6875-18 UNEF

All dimensions for reference only.

**Series I**

**C**

# Jam Nut Receptacle - Hermetic

## Military (MS27470) Commercial (LJT07 & LJTS07)

PART NUMBER BUILDER Page 113-117

**MILITARY**  
**MS27470Y**

**Commercial**

**LJT07H, LJT07Y**  
**LJTS07Y**



**Commercial**  
\* LJT07H-XX-XXX  
\*\* LJT07Y-XX-XXX  
\*\*\* LJTS07Y-XX-XXX

**Military**  
MS27470YXXD  
MS27470YXXE

- ★ .059 Dia. Min. 3 lockwire holes.  
Formed lockwire hole design  
(6 holes) is optional.
- + "D" shaped mounting hole dimensions.
- \* \*Long Junior Tri-Lock
- \*\* Interfacial seal wafer
- \*\*\* High temperature version, interfacial seal wafer with stainless steel shell

Shell Size	A+ +.000 -.010	C Max.	H Hex +.017 -.016	L Max.	N +.000 -.005	S ±.016	T+ +.010 -.000	KK +.011 -.000	RR Thread Class 2A (Plated)
9	.669	1.199	.875	.297	.572	1.062	.697	.642	.6875-24 UNEF
11	.769	1.386	1.000	.297	.700	1.250	.822	.766	.8125-20 UNEF
13	.955	1.511	1.188	.297	.850	1.375	1.007	.892	1.0000-20 UNEF
15	1.084	1.636	1.312	.297	.975	1.500	1.134	1.018	1.1250-18 UNEF
17	1.208	1.761	1.438	.297	1.100	1.625	1.259	1.142	1.2500-18 UNEF
19	1.333	1.949	1.562	.328	1.207	1.812	1.384	1.268	1.3750-18 UNEF
21	1.459	2.073	1.688	.328	1.332	1.938	1.507	1.392	1.5000-18 UNEF
23	1.580	2.199	1.812	.328	1.457	2.062	1.634	1.518	1.6250-18 UNEF
25	1.709	2.328	2.000	.328	1.582	2.188	1.759	1.642	1.7500-18 UNS

All dimensions for reference only.

# Solder Mounting Receptacle - Hermetic

**Military (MS27471), Commercial (LJTI & LJTSI)**

38999

PART NUMBER BUILDER Page 113-117

**MILITARY  
MS27471Y**

Commercial

**LJTIH, LJTIY  
LJTSIY**

Series I

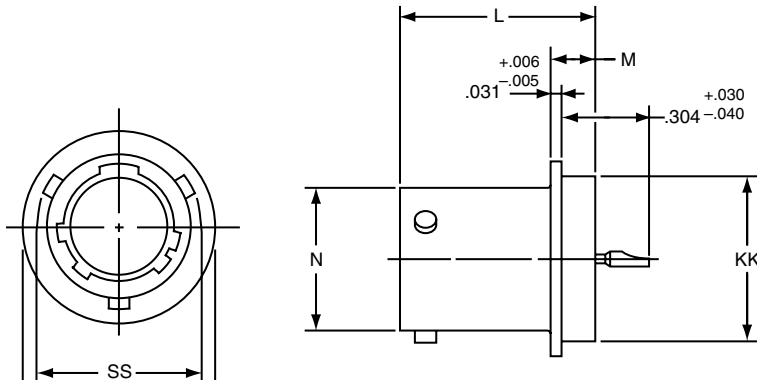

**Commercial**  
\* LJTIH-XX-XXX  
\*\* LJTIY-XX-XXX  
\*\*\* LJTSIY-XX-XXX

**Military**  
MS27471YXXD  
MS27471YXXE

- \* Long Junior Tri-Lock
- \*\* Interfacial seal wafer
- \*\*\* High temperature version, interfacial seal wafer with stainless steel shell

Shell Size	N Dia. +.001 -.005	SS Dia. +.000 -.016	L +.011 -.000	M +.006 -.005	GG Dia. +.011 -.010	KK Dia. +.001 -.005
9	.572	.662	.789	.125	.750	.672
11	.700	.810	.789	.125	.844	.781
13	.850	.960	.789	.125	.969	.906
15	.975	1.085	.789	.125	1.094	1.031
17	1.100	1.210	.789	.125	1.218	1.156
19	1.207	1.317	.789	.125	1.312	1.250
21	1.332	1.442	.789	.125	1.438	1.375
23	1.457	1.567	.821	.156	1.563	1.500
25	1.582	1.692	.821	.156	1.688	1.625

All dimensions for reference only. Weld mounting hermetic receptacle also available.  
Consult Amphenol Aerospace for availability and dimensions.

# Wall Mounting Receptacle - Solder

## Military (MS20026), Commercial (LJT00)

PART NUMBER BUILDER Page 113-117

**Military qualified to MIL-DTL-27599**

**MILITARY**  
**MS20020T**

**Commercial**

**LJT00T, LJT00C, LJT00P**

38999

- III
- II
- I
- SJT
- Access
- Aquacon

**Series I**



**Commercial**  
**LJT00T-XX-XXX**  
**LJT00C-XX-XXX**

**Military**  
**MS20026T**

**Commercial**  
**LJT00P-XX-XXX**

■  $\text{⊕}$  .005 DIA  $\text{Ⓜ}$

NOTE: For availability of back panel mounting types, check with nearest sales office or call Amphenol Aerospace.

Shell Size	F Dia.	L Max.	M +.000 - .005	N +.001 - .005	R (TP)	S ±.016	T Dia. ±.005	V Thread Class 2A UNEF (Plated)	KK Dia. Max.
9	.327	.625	.632	.572	.719	.938	.128	.4375-28	.608
11	.444	.625	.632	.700	.812	1.031	.128	.5625-24	.734
13	.558	.625	.632	.850	.906	1.125	.128	.6875-24	.858
15	.683	.625	.632	.975	.969	1.219	.128	.8125-20	.984
17	.808	.625	.632	1.100	1.062	1.312	.128	.9375-20	1.110
19	.909	.625	.632	1.207	1.156	1.438	.128	1.0625-18	1.234
21	1.034	.703	.602	1.332	1.250	1.562	.128	1.1875-18	1.360
23	1.159	.703	.602	1.457	1.375	1.688	.147	1.3125-18	1.484
25	1.284	.703	.602	1.582	1.500	1.812	.147	1.4375-18	1.610



# Line Receptacle - Solder

## Military (MS20027), Commercial (LJT01)

38999

PART NUMBER BUILDER Page 113-117

Military qualified to MIL-DTL-27599

**MILITARY** LJT01T, LJT01C, LJT01P  
**MS20027T**

Commercial



**Commercial** LJT01T-XX-XXX  
**LJT01C-XX-XXX**

**Military** MS20027T

**Commercial** LJT01P-XX-XXX

Shell Size	C Max.	F Dia.	L Max.	M +.000 / -.005	N +.001 / -.005	S ±.016	V Thread Class 2A UNEF (Plated)	KK Dia. Max.
9	1.094	.327	.625	.632	.572	.938	.4375-28	.608
11	1.188	.444	.625	.632	.700	1.031	.5625-24	.734
13	1.281	.558	.625	.632	.850	1.125	.6875-24	.858
15	1.375	.683	.625	.632	.975	1.219	.8125-20	.984
17	1.469	.808	.625	.632	1.100	1.312	.9375-20	1.110
19	1.594	.909	.625	.632	1.207	1.438	1.0625-18	1.234
21	1.719	1.034	.703	.602	1.332	1.562	1.1875-18	1.360
23	1.844	1.159	.703	.602	1.457	1.688	1.3125-18	1.484
25	1.969	1.284	.703	.602	1.582	1.812	1.4375-18	1.610

Series I





# Straight Plug -Solder

**Military (MS20028), Commercial (LJT06)**

38999

PART NUMBER BUILDER Page 113-117

**Military qualified to MIL-DTL-27599**

**MILITARY  
MS20028T**

**Commercial**

**LJT06T, LJT06C, LJT06P,**

- III
- II
- I
- SJT
- Access
- Aquacon

**Series I**

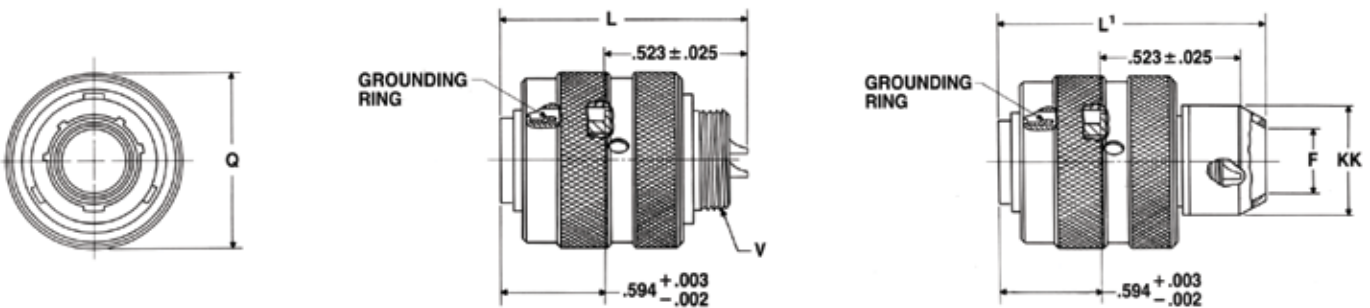

**Commercial**  
**LJT06T-XX-XXX**  
**LJT06C-XX-XXX**

**Military**  
**MS20028T**

**Commercial**  
**LJT06P-XX-XXX**

Shell Size	F Dia.	L Max.	L' Max.	Q Max.	V Thread Class 2A UNEF (Plated)	KK Dia. Max.
9	.327	1.128	1.488	.844	.4375-28	.608
11	.444	1.128	1.488	.969	.5625-24	.734
13	.558	1.128	1.488	1.141	.6875-24	.858
15	.683	1.128	1.488	1.266	.8125-20	.984
17	.808	1.128	1.488	1.391	.9375-20	1.110
19	.909	1.128	1.488	1.500	1.0625-18	1.234
21	1.034	1.128	1.566	1.625	1.1875-18	1.360
23	1.159	1.128	1.566	1.750	1.3125-18	1.484
25	1.284	1.191	1.644	1.875	1.4375-18	1.610



# Jam Nut Receptacle - Solder

## Military (MS20029), Commercial (LJT07)

38999

PART NUMBER BUILDER Page 113-117

Military qualified to MIL-DTL-27599

MILITARY  
MS20029P

Commercial  
LJT07P, LJT07T

Series I



Commercial  
LJT07T-XX-XXX

Commercial Military  
LJT07P-XX-XXX MS20029P

+ "D" shaped mounting hole dimensions

Shell Size	A+ +.000 -.010	C Max.	F Dia.	H Hex +.017 -.016	L Max.	L' Max.	N +.001 -.005	S ±.016	T+ +.010 -.000	KK +.011 -.000	KK Dia. Max.	RR Thread Class 2A (Plated)
9	.669	1.199	.327	.875	.234	.625	.572	1.062	.697	.516	.608	.6875-24UNEF
11	.769	1.386	.444	1.000	.234	.625	.700	1.250	.822	.642	.734	.8125-20UNEF
13	.955	1.511	.558	1.188	.234	.625	.850	1.375	1.007	.766	.858	1.0000-20UNEF
15	1.084	1.636	.683	1.312	.234	.625	.975	1.500	1.134	.892	.984	1.1250-18UNEF
17	1.208	1.761	.808	1.438	.234	.625	1.100	1.625	1.259	1.018	1.110	1.2500-18UNEF
19	1.333	1.949	.909	1.562	.266	.625	1.207	1.812	1.384	1.142	1.234	1.3750-18UNEF
21	1.459	2.073	1.034	1.688	.266	.656	1.332	1.938	1.507	1.268	1.360	1.5000-18UNEF
23	1.580	2.199	1.159	1.812	.266	.750	1.457	2.062	1.634	1.392	1.484	1.6250-18UNEF
25	1.709	2.323	1.284	2.000	.266	.750	1.582	2.188	1.759	1.518	1.610	1.7500-18UNS

All dimensions for reference only.

# PCB Wall Mounting Receptacle (Back Panel Mounting)

Commercial (LJTPQ00)

38999



	1.	2.	3.	4.	5.
<b>PART #</b>	Shell Finish	Base Number	Coded Shell Size	Insert Arrg.	Contact Type/Alt. Keying
See chart below	88/91	569	701	-35	P

## HOW TO ORDER

### 1. SELECT A SHELL FINISH:

<b>88</b>	Designates olive drab cadmium plated connector shell
<b>91</b>	Designates electroless nickel plated connector shell

Consult Amphenol Aerospace for ordering of composite styles.

### 2. BASE NUMBER:

<b>569</b>	Base Number
------------	-------------

### 3. SELECT A CODED SHELL SIZE:

See chart below **701-709**, designates size 9-25 shell size. Example: **701**= Size 9 Shell

■ (+) .005 DIA (M)

Shell Size	Coded Shell Size	L Max.	M +.000 -.005	N Dia.	P Max. Panel Thickness	R (TP)	S +.011 -.010	T Dia. ±.005	V Thread Class 2A (Plated)	SS Dia. +.000 -.016
9	<b>701</b>	.453	.820	.572	.234	.719	.938	.128	.4375-28 UNEF	.662
11	<b>702</b>	.453	.820	.700	.234	.812	1.031	.128	.5625-24 UNEF	.810
13	<b>703</b>	.453	.820	.850	.234	.906	1.125	.128	.6875-24 UNEF	.960
15	<b>704</b>	.453	.820	.975	.234	.969	1.219	.128	.8125-20 UNEF	1.085
17	<b>705</b>	.453	.820	1.100	.234	1.062	1.312	.128	.9375-20 UNEF	1.210
19	<b>706</b>	.453	.820	1.207	.234	1.156	1.438	.128	1.0625-18 UNEF	1.317
21	<b>707</b>	.484	.790	1.332	.204	1.250	1.562	.128	1.1875-18 UNEF	1.442
23	<b>708</b>	.484	.790	1.457	.204	1.375	1.688	.147	1.3125-18 UNEF	1.567
25	<b>709</b>	.484	.790	1.582	.193	1.500	1.812	.147	1.4375-18 UNEF	1.692

All dimensions for reference only.

Most common options are shown; other options are available.

### 4. SELECT AN INSERT ARRANGEMENT:

Refer to insert availability chart on page 2-5 and pin-out illustrations on pages 14-28.

<b>-35</b>	Designates Insert Arrangement Number
------------	--------------------------------------

### 5. CONTACT TYPE/ALTERNATE KEYING POSITIONS:

Refer to page 117 for alternate rotation letters to use.

<b>P</b>	Designates Pin Contacts in Normal Position
<b>S</b>	Designates Socket Contacts in Normal Position

# PCB Wall Mounting Receptacle (Back Panel Mounting) (With Clinch Nuts)

**Commercial (LJTPQ00)**

38999

III

II

I

SJT

Access

Aquacon

Series I



	1.	2.	3.	4.	5.
<b>PART #</b>	Shell Finish	Base Number	Coded Shell Size	Insert Arrg.	Contact Type/Alt. Keying
See chart below	88/91	628	701	-35	P

## HOW TO ORDER

### 1. SELECT A SHELL FINISH:

<b>88</b>	Designates olive drab cadmium plated connector shell
<b>91</b>	Designates electroless nickel plated connector shell

Consult Amphenol Aerospace for ordering of composite styles.

### 2. BASE NUMBER:

<b>628</b>	Base Number
------------	-------------

### 3. SELECT A CODED SHELL SIZE:

See chart below **701-709**, designates size 9-25 shell size. Example: **701** = Size 9 Shell

■ (+) .005 DIA (M)

Shell Size	Coded Shell Size	L Max.	M +.000 / -.005	N Dia.	P Max. Panel Thickness	R (TP)	S +.011 / -.010	T Thread	V Thread Class 2A (Plated)	SS Dia. +.000 / -.016
9	<b>701</b>	.453	.820	.572	.234	.719	.938	.112-40UNJC-3B	.4375-28 UNEF	.662
11	<b>702</b>	.453	.820	.700	.234	.812	1.031	.112-40UNJC-3B	.5625-24 UNEF	.810
13	<b>703</b>	.453	.820	.850	.234	.906	1.125	.112-40UNJC-3B	.6875-24 UNEF	.960
15	<b>704</b>	.453	.820	.975	.234	.969	1.219	.112-40UNJC-3B	.8125-20 UNEF	1.085
17	<b>705</b>	.453	.820	1.100	.234	1.062	1.312	.112-40UNJC-3B	.9375-20 UNEF	1.210
19	<b>706</b>	.453	.820	1.207	.234	1.156	1.438	.112-40UNJC-3B	1.0625-18 UNEF	1.317
21	<b>707</b>	.484	.790	1.332	.204	1.250	1.562	.112-40UNJC-3B	1.1875-18 UNEF	1.442
23	<b>708</b>	.484	.790	1.457	.204	1.375	1.688	.138-32UNJC-3B	1.3125-18 UNEF	1.567
25	<b>709</b>	.484	.790	1.582	.193	1.500	1.812	.138-32UNJC-3B	1.4375-18 UNEF	1.692

All dimensions for reference only.

\*Consult Amphenol for more information on ordering connectors with clinch nuts. There is also a 3mm clinch nut available (part number 88/91-628401/409)

Most common options are shown; other options are available.

### 4. SELECT AN INSERT ARRANGEMENT:

Refer to insert availability chart on page 2-5 and pin-out illustrations on pages 14-28.

<b>-35</b>	Designates Insert Arrangement Number
------------	--------------------------------------

### 5. CONTACT TYPE/ALTERNATE KEYING POSITIONS:

Refer to page 117 for alternate rotation letters to use.

<b>P</b>	Designates Pin Contacts in Normal Position
<b>S</b>	Designates Socket Contacts in Normal Position

# PCB Box Mounting Receptacle (Back Panel Mounting)

**Commercial (LJTP02)**

38999



	1.	2.	3.	4.	5.
<b>PART #</b>	Shell Finish	Base Number	Coded Shell Size	Insert Arrg.	Contact Type/Alt. Keying
See chart below	88/91	569	71X	-35	P

## HOW TO ORDER

### 1. SELECT A SHELL FINISH:

<b>88</b>	Designates olive drab cadmium plated connector shell
<b>91</b>	Designates electroless nickel plated connector shell

Consult Amphenol Aerospace for ordering of composite styles.

### 2. BASE NUMBER:

<b>569</b>	Base Number
------------	-------------

### 3. SELECT A CODED SHELL SIZE:

See chart below **711-719**, designates size 9-25 shell size. Example: **711**= Size 9 Shell

■ (+) .005 DIA (M)

Shell Size	Coded Shell Size	L Max.	M +.000 -.005	N +.001 -.005	P Max. Panel Thickness	R (TP)	S +.011 -.010	T Dia. ±.005	KK Dia. +.006 -.005	SS Dia. +.000 -.016
9	<b>711</b>	.203	.820	.572	.234	.719	.938	.128	.433	.662
11	<b>712</b>	.203	.820	.700	.234	.812	1.031	.128	.557	.810
13	<b>713</b>	.203	.820	.850	.234	.906	1.125	.128	.676	.960
15	<b>714</b>	.203	.820	.975	.234	.969	1.219	.128	.801	1.085
17	<b>715</b>	.203	.820	1.100	.234	1.062	1.312	.128	.926	1.210
19	<b>716</b>	.203	.820	1.207	.234	1.156	1.438	.128	1.032	1.317
21	<b>717</b>	.234	.790	1.332	.204	1.250	1.562	.128	1.157	1.442
23	<b>718</b>	.234	.790	1.457	.204	1.375	1.688	.147	1.282	1.567
25	<b>719</b>	.234	.790	1.582	.193	1.500	1.812	.147	1.407	1.692

All dimensions for reference only.

Most common options are shown; other options are available.

### 4. SELECT AN INSERT ARRANGEMENT:

Refer to insert availability chart on page 2-5 and pin-out illustrations on pages 14-28.

<b>-35</b>	Designates Insert Arrangement Number
------------	--------------------------------------

### 5. CONTACT TYPE/ALTERNATE KEYING POSITIONS:

Refer to page 117 for alternate rotation letters to use.

<b>P</b>	Designates Pin Contacts in Normal Position
<b>S</b>	Designates Socket Contacts in Normal Position

III  
II  
I  
SJT  
Access  
Aquacon

Series I

C

# PCB Box Mounting Receptacle (Back Panel Mounting) (With Clinch Nuts)

## Commercial (LJTP02)

38999

III

II

I

SJT

Access

Aquacon

Series I



PART #	1. Shell Finish	2. Base Number	3. Coded Shell Size	4. Insert Arrg.	5. Contact Type/Alt. Keying
See chart below	88/91	628	71X	-35	P

### HOW TO ORDER

#### 1. SELECT A SHELL FINISH:

<b>88</b>	Designates olive drab cadmium plated connector shell
<b>91</b>	Designates electroless nickel plated connector shell

Consult Amphenol Aerospace for ordering of composite styles.

#### 2. BASE NUMBER:

<b>628</b>	Base Number
------------	-------------

#### 3. SELECT A CODED SHELL SIZE:

See chart below **711-719**, designates size 9-25 shell size. Example: **711**= Size 9 Shell

■ (+) .005 DIA (M)

Shell Size	Coded Shell	L Max.	M +.000 - .005	N +.001 - .005	P Max. Panel Thickness	R (TP)	S +.011 - .010	T Thread	KK Dia. +.006 - .005	SS Dia. +.000 - .016
9	<b>711</b>	.203	.820	.572	.234	.719	1.031	.112-40UNJC-3B	.433	.662
11	<b>712</b>	.203	.820	.700	.234	.812	1.125	.112-40UNJC-3B	.557	.810
13	<b>713</b>	.203	.820	.850	.234	.906	1.172	.112-40UNJC-3B	.676	.960
15	<b>714</b>	.203	.820	.975	.234	.969	1.281	.112-40UNJC-3B	.801	1.085
17	<b>715</b>	.203	.820	1.100	.234	1.062	1.375	.112-40UNJC-3B	.926	1.210
19	<b>716</b>	.203	.820	1.207	.234	1.156	1.469	.112-40UNJC-3B	1.032	1.317
21	<b>717</b>	.234	.790	1.332	.204	1.250	1.625	.112-40UNJC-3B	1.157	1.442
23	<b>718</b>	.234	.790	1.457	.204	1.375	1.750	.138-32UNJC-3B	1.282	1.567
25	<b>719</b>	.234	.790	1.582	.193	1.500	1.875	.138-32UNJC-3B	1.407	1.692

All dimensions for reference only.

\*Consult Amphenol for more information on ordering connectors with clinch nuts. There is also a 3mm clinch nut available (part number 88/91-628410/419)

Most common options are shown; other options are available.

#### 4. SELECT AN INSERT ARRANGEMENT:

Refer to insert availability chart on page 2-5 and pin-out illustrations on pages 14-28.

<b>-35</b>	Designates Insert Arrangement Number
------------	--------------------------------------

#### 5. CONTACT TYPE/ALTERNATE KEYING POSITIONS:

Refer to page 117 for alternate rotation letters to use.

<b>P</b>	Designates Pin Contacts in Normal Position
<b>S</b>	Designates Socket Contacts in Normal Position

# PCB Jam Nut Receptacle

## Commercial (LJT07)

38999



	1.	2.	3.	4.	5.
<b>PART #</b>	Shell Finish	Base Number	Coded Shell Size	Insert Arrg.	Contact Type/Alt. Keying
See chart below	88/91	569	72*	-35	P

## HOW TO ORDER

### 1. SELECT A SHELL FINISH:

<b>88</b>	Designates olive drab cadmium plated connector shell
<b>91</b>	Designates electroless nickel plated connector shell

Consult Amphenol Aerospace for ordering of composite styles.

### 2. BASE NUMBER:

<b>569</b>	Base Number
------------	-------------

### 3. SELECT A CODED SHELL SIZE:

See chart below **721-729**, designates size 9-25 shell size.

Example: **721** = Size 9 Shell

Shell Size	Coded Shell	A* +.000 -.010	C Max.	H Hex +.017 -.016	L Max.	N +.001 -.005	S ±.016	T* +.010 -.000	V Thread Class 2A (Plated)	RR Thread Class 2A (Plated)
9	<b>721</b>	.669	1.199	.875	.625	.572	1.062	.697	.4375-28 UNEF	.6875-24 UNEF
11	<b>722</b>	.769	1.386	1.000	.625	.700	1.250	.822	.5625-24 UNEF	.8125-20 UNEF
13	<b>723</b>	.955	1.511	1.188	.625	.850	1.375	1.007	.6875-24 UNEF	1.0000-20 UNEF
15	<b>724</b>	1.084	1.636	1.312	.625	.975	1.500	1.134	.8125-20 UNEF	1.1250-18 UNEF
17	<b>725</b>	1.208	1.761	1.438	.625	1.100	1.625	1.259	.9375-20 UNEF	1.2500-18 UNEF
19	<b>726</b>	1.333	1.949	1.562	.656	1.207	1.812	1.384	1.0625-18 UNEF	1.3750-18 UNEF
21	<b>727</b>	1.459	2.073	1.688	.750	1.332	1.938	1.507	1.1875-18 UNEF	1.5000-18 UNEF
23	<b>728</b>	1.580	2.199	1.812	.750	1.457	2.062	1.634	1.3125-18 UNEF	1.6250-18 UNEF
25	<b>729</b>	1.709	2.323	2.000	.750	1.582	2.188	1.759	1.4375-18 UNEF	1.7500-18 UNS

All dimensions for reference only.

Most common options are shown; other options are available.

★ .059 dia. min. 3 lockwire holes.

Formed lockwire hole design (6 holes) is optional.

\* "D" shaped mounting hole dimensions

### 4. SELECT AN INSERT ARRANGEMENT:

Refer to insert availability chart on page 2-5 and pin-out illustrations on pages 14-28.

<b>-35</b>	Designates Insert Arrangement Number
------------	--------------------------------------

### 5. CONTACT TYPE/ KEYING POSITIONS:

Refer to page 117 for alternate rotation letters to use.

<b>P</b>	Designates Pin Contacts in Normal Position
<b>S</b>	Designates Socket Contacts in Normal Position

Series I

# PCB Hermetic Wall Mounting Receptacle

## Commercial (LJT00)

38999

III

II

I

SJT

Access

Aquacon

Series I



	1.	2.	3.	4.	5.	6.
<b>PART #</b>	Base Number	Coded Shell Size	Insert Arrg.	Contact Type/Alt. Keying Position	Shell Finish	Tail Length
See chart below	10-626	401	-35	P	1	B

## HOW TO ORDER

### 1. BASE NUMBER:

**10-626** Base Number for MIL-DTL-38999 Series III Hermetic with PCB Tail

### 2. SELECT A CODED SHELL SIZE:

See chart below **401-409**, designates size 9-25 shell size.

### 3. SELECT AN INSERT ARRANGEMENT:

Refer to insert availability chart on page 2-5 and pin-out illustrations on pages 14-28.

**-35** Designates Insert Arrangement Number

### 4. CONTACT TYPE/ALTERNATE KEYING POSITIONS:

Refer to page 117 for alternate rotation letters to use.

**P** Designates Pin Contacts in Normal Position  
**S** Designates Socket Contacts in Normal Position

### 5. SELECT A SHELL FINISH:

**1** Hermetic seal, passivated Stainless Steel, 200°C  
**2** Hermetic seal, Stainless Steel w/Nickel Plate  
**3** Carbon Steel w/reflowed tin plate

### 6. SELECT A TAIL LENGTH:

**B** .100±.03  
**D** .200±.03  
**F** .300±.03

⊕ .005 DIA (M)

Shell Size	Part Number	N Dia. +.001 -.005	R TP)	S ±.016	T Dia. ±.005	RR Thread Class 2A
9	10-626 <b>401</b> -XXX	.572	.719	.938	.128	.6875-24 UNEF
11	<b>402</b> -XXX	.700	.812	1.031	.128	.8125-20 UNEF
13	<b>403</b> -XXX	.850	.906	1.125	.128	.9375-20 UNEF
15	<b>404</b> -XXX	.975	.969	1.219	.128	1.0625-18 UNEF
17	<b>405</b> -XXX	1.100	1.062	1.312	.128	1.1875-18 UNEF
19	<b>406</b> -XXX	1.207	1.156	1.438	.128	1.3125-18 UNEF
21	<b>407</b> -XXX	1.332	1.250	1.562	.128	1.4375-18 UNEF
23	<b>408</b> -XXX	1.457	1.375	1.688	.147	1.5625-18 UNEF
25	<b>409</b> -XXX	1.582	1.500	1.812	.147	1.6875-18 UNEF

All dimensions for reference only.





	1.	2.	3.	4.	5.	6.
<b>PART #</b> See chart below	Base Number 10-626	Coded Shell Size 411	Insert Arrg. -35	Contact Type/ Alt. Keying Position P	Shell Finish 1	Tail Length B

## HOW TO ORDER

### 1. BASE NUMBER:

<b>10-626</b>	Base Number for MIL-DTL-38999 Series III Hermetic with PCB Tail
---------------	---

### 2. SELECT A CODED SHELL SIZE:

See chart below **411-419**, designates size 9-25 shell size. Example: **411** = Size 9 Shell

### 3. SELECT AN INSERT ARRANGEMENT:

Refer to insert availability chart on page 2-5 and pin-out illustrations on pages 14-28.

<b>-35</b>	Designates Insert Arrangement Number
------------	--------------------------------------

### 4. CONTACT TYPE/ KEYING POSITIONS:

Refer to page 117 for alternate rotation letters to use.

<b>P</b>	Designates Pin Contacts in Normal Position
<b>S</b>	Designates Socket Contacts in Normal Position

### 5. SELECT A SHELL FINISH:

<b>1</b>	Hermetic seal, passivated Stainless Steel, 200°C
<b>2</b>	Hermetic seal, Stainless Steel w/Nickel Plate
<b>3</b>	Carbon Steel w/reflowed tin plate

### 6. SELECT A TAIL LENGTH

<b>B</b>	.100±.03
<b>D</b>	.200±.03
<b>F</b>	.300±.03

All dimensions for reference only.  
Weld mounting hermetic receptacle also available.  
Consult Amphenol for availability and dimensions.

Shell Size	Part Number	A+ +.000 -.010	C Max.	H Hex +.017 -.016	L Max.	N +.000 -.005	S ±.016	T+ +.010 -.000	KK +.011 -.000	RR Thread Class 2A (Plated)
9	<b>10-626411</b> -XXX	.669	1.199	.875	.297	.572	1.062	.697	.642	.6875-24 UNEF
11	<b>412</b> -XXX	.769	1.386	1.000	.297	.700	1.250	.822	.766	.8125-20 UNEF
13	<b>413</b> -XXX	.955	1.511	1.188	.297	.850	1.375	1.007	.892	1.0000-20 UNEF
15	<b>414</b> -XXX	1.084	1.636	1.312	.297	.975	1.500	1.134	1.018	1.1250-18 UNEF
17	<b>415</b> -XXX	1.208	1.761	1.438	.297	1.100	1.625	1.259	1.142	1.2500-18 UNEF
19	<b>416</b> -XXX	1.333	1.949	1.562	.328	1.207	1.812	1.384	1.268	1.3750-18 UNEF
21	<b>417</b> -XXX	1.459	2.073	1.688	.328	1.332	1.938	1.507	1.392	1.5000-18 UNEF
23	<b>418</b> -XXX	1.580	2.199	1.812	.328	1.457	2.062	1.634	1.518	1.6250-18 UNEF
25	<b>419</b> -XXX	1.709	2.328	2.000	.328	1.582	2.188	1.759	1.642	1.7500-18 UNS

All dimensions for reference only.

# PCB Hermetic Solder Mounting Receptacle

## Commercial (LJTI)

38999

III

II

I

SJT

Access

Aquacon

Series I



	1.	2.	3.	4.	5.	6.
<b>PART #</b>	Base Number	Coded Shell Size	Insert Arrg.	Contact Type/ Alt. Keying Position	Shell Finish	Tail Length
See chart below	10-626	421	-35	P	1	B

## HOW TO ORDER

### 1. BASE NUMBER:

**10-626** Base Number for MIL-DTL-38999 Series III Hermetic with PCB Tail

### 2. SELECT A CODED SHELL SIZE:

See chart below **421-429**, designates size 9-25 shell size. Example: **421** = Size 9 Shell

### 3. SELECT AN INSERT ARRANGEMENT:

Refer to insert availability chart on page 2-5 and pin-out illustrations on pages 14-28.

**-35** Designates Insert Arrangement Number

### 4. CONTACT TYPE/ALTERNATE KEYING POSITIONS:

Refer to page 117 for alternate rotation letters to use.

- P** Designates Pin Contacts in Normal Position
- S** Designates Socket Contacts in Normal Position

### 5. SELECT A SHELL FINISH:

- 1** Hermetic seal, passivated Stainless Steel, 200°C
- 2** Hermetic seal, Stainless Steel w/Nickel Plate
- 3** Carbon Steel w/reflowed tin plate

### 6. SELECT A TAIL LENGTH:

- B** .100±.03
- D** .200±.03
- F** .300±.03

All dimensions for reference only.  
Weld mounting hermetic receptacle also available.  
Consult Amphenol for availability and dimensions.

Shell Size	Part Number	N Dia. +.001 -.005	SS Dia. +.000 -.016	L +.011 -.000	M +.006 -.005	GG Dia. +.011 -.010	KK Dia. +.001 -.005
9	10-626 <b>421</b> -XXX	.572	.662	.789	.125	.750	.672
11	<b>422</b> -XXX	.700	.810	.789	.125	.844	.781
13	<b>423</b> -XXX	.850	.960	.789	.125	.969	.906
15	<b>424</b> -XXX	.975	1.085	.789	.125	1.094	1.031
17	<b>425</b> -XXX	1.100	1.210	.789	.125	1.218	1.156
19	<b>426</b> -XXX	1.207	1.317	.789	.125	1.312	1.250
21	<b>427</b> -XXX	1.332	1.442	.789	.125	1.438	1.375
23	<b>428</b> -XXX	1.457	1.567	.821	.156	1.563	1.500
25	<b>429</b> -XXX	1.582	1.692	.821	.156	1.688	1.625

# Series I, LJT Breakaway Fail Safe

## Lanyard Release Plug How to Order, cont.

### HOW TO ORDER-MILITARY FAIL SAFE MS27661

1. MS Number	2. Service Class	3. Shell Size	4. Finish	5. Insert Arrg.	6. Contact Style	7. Alternate Position
<b>MS27661</b>	<b>T</b>	<b>17</b>	<b>B</b>	<b>35</b>	<b>P</b>	<b>A</b>

#### 1. MS27661 NUMBER

MS Number designates MIL-DTL-38999, Series I LJT Lanyard Release Plug

#### 2. SELECT A SERVICE CLASS

- E** For environmental crimp applications (inactive for new design)
- T** For environmental crimp applications with serrations on rear threads of shell

#### 3. SELECT A SHELL SIZE

MIL-DTL-38999, sizes 11 through 25, see chart on page 140.

#### 4. SELECT A FINISH

- B** Designates corrosion resistant olive drab cadmium plated aluminum, 500 hour extended salt spray, EMI shielding effectiveness -50dB @ 10 GHz specification min., 175°C
- F** Designates electroless nickel plated aluminum, 48 hour salt spray, EMI shielding effectiveness -65dB @ 10 GHz/500 specification min., 200°C

These are standard finishes. Consult Amphenol Aerospace for variations.

#### 5. SELECT AN INSERT ARRANGEMENT

MIL-DTL-38999, see insert identification chart on page 140.

#### 6. SELECT A CONTACT STYLE

- P** Designates Lanyard Release plug with pin contacts
- S** Designates Lanyard Release plug with socket contacts

#### 7. ALTERNATE KEYING POSITION

For alternate position of connector (to prevent cross-mating) see LJT key/keyway rotation below. (No letter is required for normal)

#### LJT Key/Keyway Rotation

##### AB ANGLE OF ROTATION (Degrees)

Shell Size	Normal	A	B	C	D
<b>9</b>	95°	77°	-	-	113°
<b>11</b>	95°	81°	67°	123°	109°
<b>13</b>	95°	75°	63°	127°	115°
<b>15</b>	95°	74°	61°	129°	116°
<b>17</b>	95°	77°	65°	125°	113°
<b>19</b>	95°	77°	<b>65°</b>	125°	113°
<b>21</b>	95°	77°	65°	125°	113°
<b>23</b>	95°	80°	69°	121°	110°
<b>25</b>	95°	80°	69°	121°	110°



### HOW TO ORDER-COMMERCIAL FAIL SAFE 88-5388 OR 91-5388

1. Finish	2. Connector Type Identification	3. Shell Size & Insert Arrangement	4. Lanyard Length Code	5. Contact Type Alternate Rotation of Insert
<b>88</b>	<b>5388</b>	<b>29</b>	<b>40</b>	<b>P</b>

#### 1. SELECT A FINISH

- 88** Designates corrosion resistant olive drab cadmium plate over nickel, 500 hour extended salt spray, EMI -50dB @ 10 GHz specification min., 175°C
- 91** Designates electroless nickel plated aluminum, optimum EMI shielding effectiveness -65dB @ 10 GHz specification min., 48 hour salt spray, 200°C

These are standard finishes. Consult Amphenol Aerospace, Sidney, NY for variations.

#### 2. CONNECTOR TYPE IDENTIFICATION

- 5388** Designates MIL-DTL-38999, Series I LJT Lanyard Release Plug

#### 3. SELECT A SHELL SIZE & INSERT ARRANGEMENT

Shell sizes are MIL-DTL-38999, Series III from sizes 11 thru 25. The basic part number selected specifies the insert arrangement. See Table I (page 140) for coded part number that correlates to insert arrangement.

#### 4. SELECT A LANYARD LENGTH CODE

See Table II (page 140) for lanyard length code number.

#### 5. SELECT A CONTACT TYPE/ALTERNATE ROTATION OF INSERT

- P** Designates Lanyard Release plug with pin contacts
- S** Designates Lanyard Release plug with socket contacts

When an alternate position of the connector is required to prevent cross-mating, a different letter (other than P or S) is used. See alternate positioning for LJT (to your left), then convert to Amphenol commercial coding by the following chart below.

Pin Contacts		Socket Contacts	
MS Letter	Amphenol Letter	MS Letter	Amphenol Letter
P	P (normal)	S	S (normal)
PA	E	SA	F
PB	R	SB	T
PC	W	SC	X
PD	Y	SD	Z

# Series I, LJT Breakaway Fail Safe

## Lanyard Release Plug Insert Availability

38999

### INSERT AVAILABILITY

Shell Size / Insert Arrangement	Service Rating	Total Contacts	Contact Size						
			22D	20	16	12	12 Coax	8 Coax*	8 Twinax
11-2	I	2			2				
11-35	M	13	13						
11-98	I	6		6					
13-4	I	4			4				
13-8	I	8		8					
13-35	M	22	22						
13-98	I	10		10					
15-5	II	5			5				
15-15	I	15		14	1				
15-18	I	18		18					
15-19	I	19		19					
15-35	M	37	37						
15-97	I	12		8	4				
17-6	I	6				6			
17-8	II	8			8				
17-26	I	26		26					
17-35	M	55	55						
17-99	I	23		21	2				
19-11	II	11			11				
19-32	I	32		32					
19-35	M	66	66						
21-11	I	11				11			
21-16	II	16			16				
21-35	M	79	79						
21-39	I	39		37	2				
21-41	I	41		41					
23-21	II	21			21				
23-35	M	100	100						
23-53	I	53		53					
23-54	M	53	40		9	4			
23-55	I	55		55					
25-4	I	56		48	8				
25-19	I	19				19			
25-20	N	30		10	13		4		3
25-24	I	24			12	12			
25-29	I	29			29				
25-35	M	128	128						
25-43	I	43		23	20				
25-46	I	46		40	4			2*	
25-61	I	61		61					

#### LJT Lanyard Separation Forces

Shell Size	Straight Plug (lbs. max.)	15 Degree Pull (lbs. Max.)
11 13 15	45	55
17 19 21 23 25	90	100

\* For RG 180/U and RG 195/U cables only. (Check Amphenol Aerospace, Sidney, NY for other cable applications). For availability of other insert arrangements and accessories consult Amphenol Aerospace.

**TABLE I  
INSERT ARRANGEMENT CODE**

Basic Part Number	MIL-DTL-38999 Insert Arrangement
88/91-538808	11-99
06	11-35
07	11-98
10	13-4
11	13-8
13	13-98
14	13-35
18	15-5
22	15-18
19	15-19
20	15-35
27	17-6
28	17-8
29	17-26
30	17-35
31	17-99
37	19-11
39	19-32
40	19-35
47	21-11
48	21-16
49	21-35
50	21-41
51	21-39
57	23-21
58	23-35
59	23-53
60	23-55
66	25-19
74	25-4
67	25-29
68	25-35
69	25-43
70	25-61
71	25-46
72	25-2

**TABLE II  
LANYARD LENGTH  
CODES**

Lanyard Length (in.) ±.250	MS	Commercial Code
4.000		40
4.250		41
4.500		42
4.750		43
5.000		50
5.250		51
5.500		52
5.750		53
6.000	No	60
6.250	Code	61
6.500		62
6.750	Std.	63
7.000	Length	70
7.250	6.250	71
7.500		72
7.750		73
8.000		80
8.250		81
8.500		82
8.750		83
9.000		90
9.250		91
9.500		92
9.750		93



# Series I, LJT Breakaway Fail Safe

## Quick-Disconnect with Axial Pull of Lanyard

38999

III  
II  
I  
SJT  
Access  
Aquacon

Series I

Amphenol LJT Breakaway Fail Safe Connectors provide unequalled performance in environments requiring instant disengagement.

Designed to provide quick disconnect of a connector plug and receptacle with an axial pull on the lanyard, the "Breakaway" Fail Safe connector family offers a wide range of electrical and mechanical features:

- Instant decoupling and damage free separation
- Completely intermateable with standard LJT receptacles
- Inventory support commonality through the use of standard insert arrangements and contacts

Breakaway un-mating is initiated by applying a pull force to the lanyard which causes the operating sleeve on the plug to move away from the receptacle. Coupling segments on the plug then move away from the mating receptacle while expanding, thus releasing the receptacle. After completion of the un-mating sequence, spring compression returns the sleeve and segments to their original positions. Un-mating of the plug may also be accomplished by normal rotation of the coupling ring without affecting the breakaway capability.

The LJT Breakaway Fail Safe connector features which provide EMI EMP shielding in excess of MIL-DTL-38999 Series I requirements:

- Solid metal-to-metal coupling
- EMI grounding fingers
- Conductive finishes

Contact Amphenol Aerospace for more information on breakaway, quick-disconnect connectors. Other Amphenol cylindrical families (MIL-DTL-38999 Series III, MIL-DTL-26482, MIL-DTL-83723) also offer breakaway quick-disconnect connectors.



### LJT Breakaway Fail Safe

In addition to standard Breakaway connectors, Amphenol also manufactures custom breakaway connectors including those with:

- Increased pull-force capability
- Custom lanyard lengths and backshells
- Low force separation capabilities
- Low insertion/separation force contacts
- Non-cadmium finishes

Custom JT Series Breakaway designs have been developed for special applications; however the LJT Series is recommended over the JT Series for the quick-disconnect breakaway style.

## Lanyard Release Plug - Fail Safe

### Military (MS27661)

### Commercial (LJT 88-5388/91-5388)

To complete order number see page 140.



Shell Size	A Dia. Max.	B Max.	D Max. Accessory Dia.	L Max.	V Thread UNEF Class 2A (Plated)
11	1.393	1.797	.740	1.703	.5625-24
13	1.558	1.969	.926	1.703	.6875-24
15	1.669	2.078	1.051	1.703	.8125-20
17	1.797	2.203	1.176	1.703	.9375-20
19	1.926	2.323	1.300	1.703	1.0625-18
21	2.054	2.469	1.426	1.703	1.1875-18
23	2.183	2.594	1.551	1.703	1.3125-18
25	2.293	2.703	1.676	1.766	1.4375-18

All dimensions for reference only.

## D



### TABLE OF CONTENTS FOR SECTION D

Features, Specification . . . . .	143
How to Order . . . . .	144
Insert Availability . . . . .	145

#### SJT SHELL STYLES:

Crimp Wall Mounting Receptacle SJT00RT . . . . .	146
Crimp Wall Mount Receptacle Back Panel Mount SJTP00RT . . . . .	146
Crimp Box Mounting Receptacle for Back Panel Mounting SJTP02RE . . . . .	147
Crimp Jam Nut Receptacle SJT07RT . . . . .	147
Crimp Straight Plug SJT06RT . . . . .	148
Crimp Straight Plug with Grounding Fingers . . . . .	148
Hermetic Solder Mounting Receptacle SJTIY . . . . .	149
Hermetic Jam Nut Receptacle SJT07Y . . . . .	149

#### ACCESSORIES:

Section F . . . . .	164-183
---------------------	---------

# Amphenol SJT

## Features, Specifications

Amphenol® SJT connectors combine unique design features of the scoop-proof LJT series within standard mounting dimensions of JT types. Available in a wide range of shell sizes, finishes, insert arrangements and accessories.

### Components

Standard connectors use aluminum shells. Standard plating on shell components is cadmium over nickel with many optional finishes available. A dependable 5-key/keyway shell polarization with bayonet-lock coupling is incorporated to aid and assure positive mating.

The insert material is a high-temperature, rigid dielectric polymer providing excellent electrical characteristics. A fluorinated silicone interfacial seal is featured on the mating face of the pin inserts, assuring complete electrical isolation of the pins when connector halves are mated. Contrasting letter or number designations are used on the insert faces. A main joint gasket is installed in the receptacles for moisture sealing between connector halves.

Serrated and threaded shells, with a moisture sealing pilot for back shells, accept a wide range of accessories. Hermetic seal receptacles are available in carbon steel or stainless steel shells.

### Contacts

Rear insertable/rear release crimp contacts are standard in SJT connectors. Power contacts are available in sizes 10, 12, 16, 20, 22M and 22D. All socket contacts are probe proof. Standard contact plating is 50 μm minimum gold. Coaxial contacts are available in sizes 8, 12 and 16 to accommodate a wide range of coaxial cables; see Coaxial contact information in the High Speed Contact section of this catalog. Size 8 and 12 Twinax contacts are also available; see Concentric Twinax contact information in the High Speed Contact section of this catalog.

### Optional Features

Special adaptations of the SJT are available for hermetic and high temperature applications. The SJTS high temperature connector is rated at 392°F. SJT hermetic receptacles are described on page 150.

### Specials

Special types are available, such as connectors less contacts and circular rack and panel connectors with solderless wrap contacts. A complete listing of connector types, shell styles and service classes appears on page 145, How to Order. For further information on special application requirements, contact an Amphenol Sales Person or visit [www.amphenol-aerospace.com](http://www.amphenol-aerospace.com) for more information.



### SJT features:

- 100% scoop-proof design – basic MIL-DTL-38999 Series I\* lengths
- Standard mounting dimensions – MIL-DTL-38999, Series II\*\* dimensions
- Compliance with European Specifications – PAN6433-2, LN29729, VG96912

38999

III
II
I
<b>SJT</b>
Access
Aquacon

SJT

### CONTACT RATING

Contact Size	Test Current		Maximum Millivolt Drop Crimp*	Maximum Millivolt Drop Hermetic
	Standard	Hermetic		
22M	3	2	45	60
22D	5	3	73	85
22	5	3	73	85
20	7.5	5	55	60
16	13	10	49	85
12	23	17	42	85
10 Power	33	NA	33	NA

\* When using silver plated wire

Contact Size	Crimp Well Data	
	Well Diameter	Min. Well Depth
22M	.028 ±.001	.141
22D	.0345 ±.0010	.141
22	.0365 ±.0010	.141
20	.047 ±.001	.209
16	.067 ±.001	.209
12	.100 ±.002	.209
10 (Power)	.137 ±.002	.355

### SERVICE RATING\*\*

Service Rating	Suggested Operating Voltage (Sea Level)		Test Voltage (Sea Level)	Test Voltage 50,000 Ft.	Test Voltage 70,000 Ft.	Test Voltage 110,000 Ft.
	AC (RMS)	DC				
M	400	550	1300 VRMS	550 VRMS	350 VRMS	200 VRMS
N	300	450	1000 VRMS	400 VRMS	260 VRMS	200 VRMS
I	600	850	1800 VRMS	600 VRMS	400 VRMS	200 VRMS
II	900	1250	2300 VRMS	800 VRMS	500 VRMS	200 VRMS

\*\* Please note that the establishment of electrical safety factors is left entirely in the designer's hands, since he is in the best possible position to know what peak voltage, switching surges, transients, etc., can be expected in a particular circuit.

# SJT

## How to Order, Alternate Rotations

38999

III

II

I

SJT

Access

Aquacon

SJT

1.	2.	3.	4.	5.
Connector Type SJT, Shell Style, Service Class	Shell Size-Insert Arrangement.	Contact Type	Alternate Keying Position	Finish Variations Suffix
<b>SJT00RT</b>	<b>18-66</b>	<b>P</b>	<b>A</b>	<b>(XXX)</b>

		SJT SERIES		
		Standard Scoop-Proof Junior Tri-Lock	High Temperature	Back Panel Mounted
CONNECTOR TYPE & STYLE	Receptacle Crimp	Wall Mounting Receptacle (without rear accessories)	SJT00RT	SJTP00RT
		Box Mounting Receptacle (with grommet & nut) (can be supplied with strain relief intergral)		SJTP02RE
		Jam Nut Receptacle (without rear accessories)	SJT07RT	
Plugs		Straight Plug	SJT06RT	
		Straight Plug with Grounding Fingers	SJTG06RT	
Fused compression glass sealed inserts. Leakage rate less than 1.0x10-6 cc/sec at 15 psi differential; with interfacial seal.				
Hermetic		Jam Nut Receptacle	SJT07Y	
		Solder Mounting Receptacle	SJTIY	

### 2. SHELL SIZE & INSERT ARRANGEMENT SEE PAGE 145

First number represents Shell Size, second number is the Insert Arrangement.

### 4. ALTERNATE KEYING POSITION

A plug with a given rotation letter will mate with a receptacle with the same rotation letter. The AB angle for a given connector is the same whether it contains pins or sockets. Inserts are not rotated in conjunction with the master key/keyway.

AB angles shown are viewed from the front face of the connector. A receptacle is shown below. The angles for the plug are exactly the same, except the direction of rotation is opposite of that shown for the receptacle.

#### KEY/KEYWAY ROTATION AB ANGLE OF ROTATION (DEGREES)

Shell Size	Normal	A	B	C	D
8	95				
10	95	81	67	123	109
12	95	75	63	127	115
14	95	74	61	129	116
16	95	77	65	125	113
18	95	77	65	125	113
20	95	77	65	125	113
22	95	80	69	121	110
24	95	80	69	121	110



RELATIVE POSSIBLE POSITION OF ROTATED MASTER KEYWAY (front face of receptacle shown)

### 3. CONTACT TYPE

P	Pin Contacts
S	Socket Contacts

### 5. FINISH VARIATION SUFFIX

Finish	Suffix	Indicated Finish Standard for SJT Types
Aluminum Shell Components Non-Hermetic		
Bright Cadmium Plated Nickel Base		<b>SJT/SJTG</b>
Anodic Coating (Alumilite)	<b>(005)</b>	
Chromate Treated (Iridite 14-2)	<b>(011)</b>	
Olive Drab Cadmium Plate Nickel Base	<b>(014)</b>	
Electroless Nickel Coating	<b>(023)</b>	
Hermetic Connectors		
Carbon Steel Shell, Tin Plated Shell and Contacts		<b>SJT( JY</b>
Stainless Steel Shell, Gold Plated Contacts	Consult Amphenol	

D



**Insert Availability and Identification**

Shell Size	Crimp	Hermetics* Class Y	Service Rating	Total Contacts	Contact Size										
					22D	22M	22	20	16	12	12 (Coax)	10 (Power)	8 (Coax)	8††† (Twinax)	
8-6	X		M	6		6									
8-35	X		M	6	6										
8-44	X		M	4			4								
8-98	X		I	3				3							
10-2	X		I	2					2						
10-4	◆		I	4				4							
10-5	X		I	5				5							
10-13	X		M	13		13									
10-35	X		M	13	13										
10-98	X		I	6				6							
12-4	X		I	4					4						
12-8	X		I	8				8							
12-22	X		M	22		22									
12-35	X		M	22	22										
12-98	X	X	I	10				10							
14-5	X		II	5					5						
14-15	X		I	15				14	1						
14-18	X		I	18				18							
14-19	X	X	I	19				19							
14-35	X	X	M	37	37										
14-37	X	X	M	37		37									
14-97	X		I	12				8	4						
16-2	◆		M	39	38										1**
16-6	X		I	6						6					
16-8	X		II	8					8						
16-13	◆		I	13					13						
16-26	X		I	26				26							
16-35	X		M	55	55										
16-42	X		M	42			42								
16-55	X		M	55		55									
16-99	X	X	I	23				21	2						
18-11	X		II	11					11						
18-32	X		I	32				32							
18-35	X	X	M	66	66										
18-66	X	X	M	66		66									
20-1	X	X	M	79		79									
20-2	X		M	65			65								
20-11	X		I	11						11					
20-16	X		II	16					16						
20-35	X	X	M	79	79										
20-39	X		I	39				37	2						
20-41	X		I	41				41							
20-75	◆		M	4										4††	
20-79	◆		II	19	17									2†	
22-1	X	X	M	100		100									
22-2	X		M	85			85								
22-21	X		II	21					21						
22-35	X	X	M	100	100										
22-53	X		I	53				53							
24-1	X		M	128		128									
24-2	X		M	100			100								
24-4	X		I	56				48	8						
24-7	X		M	99	97										2**
24-11	◆		N	11				2				9			
24-19	X		I	19						19					
24-20	◆		N	30				10	13***		4				3
24-24	X		I	24					12	12					
24-29	X		I	29					29						
24-35	X		M	128	128										
24-37	X		I	37					37						
24-43	◆		I	43				23	20						
24-46	◆		I	46				40	4					2††	
24-61	X		I	61				61							

◆ Not tooled for 02-RE

\* Pin inserts only (contact Amphenol for socket availability).

\*\* twinax contacts for MIL-C-17/176-00002 cable.

\*\*\* Two size 16 contacts dedicated to fiber optics. Consult Amphenol or Fiber Optic Section for more information.

† Must be ordered separately

†† Coax Contacts for RG180 or RG195 cable.

††† Size 8 Coax and Twinax are interchangeable.

For availability of size 12 twinax contacts, consult Amphenol Aerospace.

38999

III

II

I

SJT

Access

Aquacon

SJT

D

# SJT00RT – Crimp Wall Mounting Receptacle

38999  
III  
II  
I  
SJT  
Access  
Aquacon

PART NUMBER BUILDER Page 144

Commercial  
SJT00RT



Note: Standard wall mount may be back panel mounted where panel thickness does not exceed these dimensions. For thicker panel applications, SJTP00RT should be used.

Shell Size	L Max	M +.000 - .005	R (TP)	S ±.016	T ±.005	V Thread Modified			N +.001 - .005	P** Max
						Class 2A UNEF (Plated)	Modified Major Dia.			
8	.500	.632	.594	.812	.120	.4375-28	.421 -	.417	.473	.117
10	.500	.632	.719	.938	.120	.5625-24	.542 -	.538	.590	.117
12	.500	.632	.812	1.031	.120	.6875-24	.667 -	.663	.750	.117
14	.500	.632	.906	1.125	.120	.8125-20	.791 -	.787	.875	.117
16	.500	.632	.969	1.219	.120	.9375-20	.916 -	.912	1.000	.117
18	.500	.632	1.062	1.312	.120	1.0625-18	1.034 -	1.030	1.125	.117
20	.500	.602	1.156	1.438	.120	1.1875-18	1.158 -	1.154	1.250	.087
22	.500	.602	1.250	1.562	.120	1.3125-18	1.283 -	1.279	1.375	.087
24	.550	.602	1.375	1.688	.147	1.4375-18	1.408 -	1.404	1.500	.055



SJT

# SJTP00RT – Crimp Wall Mounting Receptacle (Back Panel Mounting)

PART NUMBER BUILDER Page 144

Commercial  
SJTP00RT



Shell Size	F +.000 - .005	K +.006 - .000	L Max.	M +.000 - .005	R (TP)	S +.011 - .010	T ±.005	Z ±.031	V Thread Class 2A UNEF (Plated)	P Dia. +.001 - .005	W Max.	G Max.
8	.609	.945	.539	.860	.594	.812	.120	.062	.4375-28	.516	.812	.345
10	.609	.945	.539	.860	.719	.938	.120	.062	.5625-24	.633	.812	.345
12	.609	.945	.539	.860	.812	1.031	.120	.062	.6875-24	.802	.812	.345
14	.609	.945	.539	.860	.906	1.125	.120	.062	.8125-20	.927	.812	.345
16	.609	.945	.539	.860	.969	1.219	.120	.062	.9375-20	1.052	.812	.345
18	.609	.945	.539	.860	1.062	1.312	.120	.062	1.0625-18	1.177	.812	.345
20	.609	.945	.539	.860	1.156	1.438	.120	.062	1.1875-18	1.302	.812	.345
22	.609	.945	.539	.860	1.250	1.562	.120	.062	1.3125-18	1.427	.812	.345
24	.750	1.085	.493	1.000	1.375	1.688	.147	.078	1.4375-18	1.552	.781	.452



All dimensions for reference only.

D

# SJTP02RE – Crimp

## Box Mounting Receptacle (Back Panel Mounting)

PART NUMBER BUILDER Page 144

Commercial  
SJTP02RE



Shell Size	F +.000 -.005	K +.006 -.000	M +.000 -.005	R (TP)	S +.011 -.010	T ±.005	Z ±.031	P Dia. +.001 -.005	KK Dia. +.005 -.002	G Max.
8	.609	.945	.860	.594	.812	.120	.062	.516	.417	.345
10	.609	.945	.860	.719	.938	.120	.062	.633	.538	.345
12	.609	.945	.860	.812	1.031	.120	.062	.802	.663	.345
14	.609	.945	.860	.906	1.125	.120	.062	.927	.787	.345
16	.609	.945	.860	.969	1.219	.120	.062	1.052	.912	.345
18	.609	.945	.860	1.062	1.312	.120	.062	1.177	1.030	.345
20	.609	.945	.860	1.156	1.438	.120	.062	1.302	1.154	.345
22	.609	.945	.860	1.250	1.562	.120	.062	1.427	1.279	.345
24	.750	1.085	1.000	1.375	1.688	.147	.078	1.552	1.404	.452

# SJT07RT – Crimp

## Jam Nut Receptacle

PART NUMBER BUILDER Page 144

Commercial  
SJT07RT



- “D” shaped panel cut-out dimensions
- \*\* Oversize threads. Check accessory threads before ordering

Shell Size	A* +.000 -.010	H Hex +.017 -.016	S ±.016	V Thread Class 2A UNEF (Plated)	R Thread Class 2A UNEF (Plated)	N +.001 -.005	C Max.	T* +.010 -.000
8	.542	.750	.938	.5625-24	.5625-24	.473	1.078	.572
10	.669	.875	1.062	.6875-24	.6875-24	.590	1.203	.697
12	.830	1.062	1.250	.8125-20	.8750-20	.750	1.391	.884
14	.955	1.188	1.375	.9375-20	1.0000-20	.875	1.515	1.007
16	1.084	1.312	1.500	1.0625-18	1.1250-18	1.000	1.641	1.134
18	1.208	1.438	1.625	1.1875-18	1.2500-18	1.125	1.766	1.259
20	1.333	1.562	1.812	1.3125-18	1.3750-18	1.250	1.953	1.384
22	1.459	1.688	1.938	1.4375-18	1.5000-18	1.375	2.078	1.507
24	1.580	1.812	2.062	1.4375-18	1.6250-18	1.500	2.203	1.634



All dimensions for reference only.

38999

III

II

I

SJT

Access

Aquacon

SJT

D

# SJT06RT/SJTG06RT – Crimp Straight Plug/Straight Plug (with Grounding Fingers)

38999

PART NUMBER BUILDER Page 144

Commercial

SJT06RT  
SJTG06RT

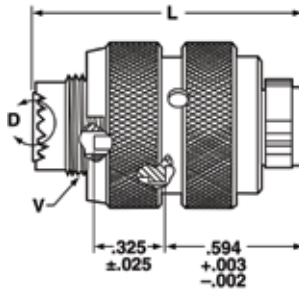

SJT06RT



SJTG06RT

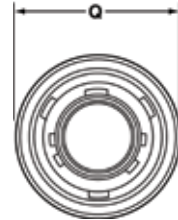

Shell Size	L Max	Q Dia. Max.	V Thread	
			Class 2A UNEF (Plated)	Modified Major Dia.
8	1.219	.734	.4375-28	.421 – .417
10	1.219	.844	.5625-24	.542 – .538
12	1.219	1.016	.6875-24	.667 – .663
14	1.219	1.141	.8125-20	.791 – .787
16	1.219	1.265	.9375-20	.916 – .912
18	1.219	1.391	1.0625-18	1.034 – 1.030
20	1.219	1.500	1.1875-18	1.158 – 1.154
22	1.219	1.625	1.3125-18	1.283 – 1.279
24	1.258	1.750	1.4375-18	1.408 – 1.404

All dimensions for reference only.

SJT

D

# SJTIY – Hermetic Solder Mounting Receptacle

PART NUMBER BUILDER Page 144

Commercial  
SJTIY



38999

III
II
I
<b>SJT</b>
Access
Aquacon

Shell Size	L +.011 -.000	M +.006 -.005	G Dia. +.011 -.010	K Dia. +.001 -.005	N +.001 -.005
8	.789	.125	.687	.562	.473
10	.789	.125	.797	.672	.590
12	.789	.125	.906	.781	.750
14	.789	.125	1.031	.906	.875
16	.789	.125	1.156	1.031	1.000
18	.789	.125	1.281	1.156	1.125
20	.789	.125	1.375	1.250	1.250
22	.821	.156	1.500	1.375	1.375
24	.821	.156	1.625	1.500	1.500

# SJT07Y – Hermetic Jam Nut Receptacle

PART NUMBER BUILDER Page 144

Commercial  
SJT07Y



SJT

- “D” shaped panel cut-out dimensions

Shell Size	N +.001 -.005	C Max.	A* +.000 -.010	L Max.	H Hex +.017 -.016	S ±.016	KK +.011 -.000	RR Thread Class 2A UNEF (Plated)	T* +.010 -.000
8	.473	1.078	.542	.297	.750	.938	.642	.5625-24	.572
10	.590	1.203	.669	.297	.875	1.062	.766	.6875-24	.697
12	.750	1.391	.830	.297	1.062	1.250	.892	.8750-20	.884
14	.875	1.515	.955	.297	1.188	1.375	1.018	1.0000-20	1.007
16	1.000	1.641	1.084	.297	1.312	1.500	1.142	1.1250-18	1.134
18	1.125	1.766	1.208	.328	1.438	1.625	1.268	1.2500-18	1.259
20	1.250	1.953	1.333	.328	1.562	1.812	1.392	1.3750-18	1.384
22	1.375	2.078	1.459	.328	1.688	1.938	1.518	1.5000-18	1.507
24	1.500	2.203	1.580	.328	1.812	2.062	1.642	1.6250-18	1.634

All dimensions for reference only.

D

## E



### TABLE OF CONTENTS FOR SECTION E

Design Features . . . . .	151
Specifications, Alternate Positioning . . . . .	152
Insert Availability . . . . .	153
Insert Arrangements . . . . .	154-155
How to Order . . . . .	156

### SJT SHELL STYLES:

AJ6/AS6 Straight Plug . . . . .	157
AJ7H/ AS7H Hermetic Jam Nut Receptacle . . . . .	158
AJ7/ AS7 Jam Nut Receptacle . . . . .	159
AJOH Hermetic Square Flange Receptacle . . . . .	160

### ACCESSORIES/INSTALLATION SECTION F:

Protection Caps . . . . .	161
Installation Instructions/ Application Tools . . . . .	162
Contact Installation . . . . .	163

## Design Features

The Amphenol® Aquacon Series of connectors has been designed to provide maximum service in oceanic or fluid immersion applications.

The AJ Aquacon offers the following features:

- 1500 PSI Capability
- “O” Ring Sealing, Thread
- Threaded Coupling
- Visual Mating Indication
- Design Flexibility

A specially designed aluminum bronze coupling nut and type 316 stainless steel shells resist corrosion and provide a pressure withstanding connector. Positive threaded coupling. “O” rings, and a color band visual indicator assure sealing and proper mating. A rear accessory thread provides for the use of EMI hardware or molding adapters.

Aquacon Connectors are available in a straight plug and two receptacle styles (see photos at right), with numerous MIL-DTL-38999 insert patterns.

AJ Aquacons use JT (38999 type) inserts that incorporate contact sizes 22D, 22M, 22, 20 or 16. AS Aquacons use SJT (38999 type) inserts that incorporate size 12 contacts. Hermetically sealed (1 X 10<sup>-6</sup> cc/sec leakage rate) arrangements are also available.

### DESIGN FEATURES OF AQUACON SERIES CONNECTORS



1. Corrosion resistant aluminum bronze coupling nut and stainless steel sleeve
2. Hermetic and non-hermetic inserts in MIL-DTL-38999 patterns. Glass or hard dielectric material.
3. Visual mating indicator
4. 1500 PSI sealing capability assured by threaded coupling and “O” ring
5. Pin or socket contacts in either plug or receptacle
6. Environmental resistant molded cable terminations with or without EMI accessory



**STRAIGHT PLUG**  
AJ6 / AS6



**HERMETIC JAM NUT RECEPTACLE**  
AJ7H/AS7H

**NON-HERMETIC JAM NUT RECEPTACLE**  
AJ7 / AS7



**HERMETIC SQUARE FLANGE RECEPTACLE**  
AJ0H

38999

III

II

I

SJT

Access

Aquacon

Aquacon

E

# Aquacon Series

## Specifications, Alternate Positioning

38999

### AQUACON CONTACT RATINGS

Contact Size	Test Current		Maximum Millivolt Drop			Crimp Well Data		Solder Well Data		
	Standard	Hermetic	Crimp	Solder	Solder Hermetic	Diameter	Depth	Diameter	Depth	
22M	3	2	30	20	60	.029 ±.001	.141	.029	+0.004 -0.000	.094
22D	5	-	40	-	-	.0345 ±.001	.141	-	-	-
22	5	3	40	20	85	.0365 ±.001	.141	.036	+0.004 -0.000	.094
20	7.5	5	35	20	60	.047 ±.001	.209	.044	+0.004 -0.000	.125
16	13	10	25	20	85	.067 ±.001	.209	.078	+0.004 -0.002	.141
12	23	17	25	20	85	.100 ±.002	.209	.116 ±.004	-	.151

### AQUACON SERVICE RATINGS

Service Rating	Suggested Operating Voltage (Sea Level)	
	AC (RMS)	DC
M	400	550
I	600	850
II	900	1250

The establishment of electrical safety factors is left entirely in the designer's hands, as he can best determine what peak voltage, switching surges, transients, etc. can be expected in a particular circuit.

### ALTERNATE POSITIONING

Alternate positioning of connectors allows connectors with identical insert arrangements to be mounted side by side by providing a positive means of eliminating inadvertent cross-mating or cross-plugging.

Alternate positioning of Aquacon Series is achieved by a rotation of the master key/keyway, relative to the insert, as part of the shell manufacturing operation.

Recommended practice is to use alternate position inserts only when necessary.

### AQUACON MASTER KEY/KEYWAY ROTATION

Shell Size	AB Angle of Rotation (Degrees)				
	Normal	A	B	C	D
8	100	82			118
10	100	86	72	128	114
12	100	80	68	132	120
14	100	79	66	134	121
16	100	82	70	130	118
18	100	82	70	130	118
20	100	82	70	130	118
22	100	85	74	126	115
24	100	85	74	126	115



RELATIVE POSSIBLE POSITION OF ROTATED MASTER KEYWAY  
(FRONT FACE OF AJ or AS RECEPTACLE SHOWN)



Aquacon Shell Size	Solder	Crimp	Hermetic*	Service Rating**	Total Contacts	Contact Size					
						22D	22M	22	20	16	12
8-3	X		X	M	3				3		
8-6	X	X	X	M	6		6				
8-35		X	X	M	6	6					
8-44		X		M	4			4			
8-98		X	X	I	3				3		
10-5	X	X	X	I	5				5		
10-13	X	X	X	M	13		13				
10-35		X	X	M	13	13					
10-98	X	X	X	I	6				6		
12-3	X	X	X	II	3					3	
12-8	X	X	X	I	8				8		
12-35		X	X	M	22	22					
12-98	X	X	X	I	10				10		
14-5	X	X	X	II	5					5	
14-15	X	X		I	15				14	1	
14-18	X	X	X	I	18				18		
14-35		X	X	M	37	37					
14-37	X	X	X	M	37		37				
16-6†		X	X	I	6						6
16-8	X	X	X	II	8					8	
16-26	X	X	X	I	26				26		
16-35		X	X	M	55	55					
16-55	X	X	X	M	55		55				
18-11	X	X		II	11					11	
18-32	X	X	X	I	32				32		
18-35		X	X	M	66	66					
18-66	X	X	X	M	66		66				
20-1		X		M	79		79				
20-2		X		M	65			65			
20-16	X	X	X	II	16					16	
20-35		X		M	79	79					
20-39	X	X		I	39				37	2	
20-41	X	X	X	I	41				41		
22-2	X	X		M	85			85			
22-21	X	X	X	II	21					21	
22-32	X			I	32				32		
22-35		X		M	100	100					
22-55	X	X	X	I	55				55		
24-19†		X	X	I	19						19
24-24†		X		I	24					12	12
24-35		X		M	128	128					
24-61	X	X		I	61				61		

\* Tooled for pin inserts only (contact Amphenol for socket availability).

\*\* See specifications

† AS Aquacon version - these arrangements use SJT (38999 type) patterns that incorporate size 12 contacts. See how to order page 156.

Additional insert arrangements may be made available upon request.

- III
- II
- I
- SJT
- Access

Aquacon

Aquacon

E

# Aquacon Series

## Insert Arrangements

38999

Front face of pin inserts illustrated



Insert Arrangement	8-3	8-6	8-35	8-44	8-98	10-5	10-13	10-35
Service Rating	M	M	M	M	I	I	M	M
Number of Contacts	3	6	6	4	3	5	13	13
Contact Size	20	22M	22D	22	20	20	22M	22D



Insert Arrangement	10-98	12-3	12-8	12-35	12-98	14-5	14-15	14-18	
Service Rating	I	II	I	M	I	II	I	I	
Number of Contacts	6	3	8	22	10	5	14	1	18
Contact Size	20	16	20	22D	20	16	20	16	20



Insert Arrangement	14-35	14-37	16-6†	16-8	16-26	16-35
Service Rating	M	M	I	II	I	M
Number of Contacts	37	37	6	8	26	55
Contact Size	22D	22M	12	16	20	22D



Insert Arrangement	16-55	18-11	18-32	18-35	18-66	20-1
Service Rating	M	II	I	M	M	M
Number of Contacts	55	11	32	66	66	79
Contact Size	22M	16	20	22D	22M	22M

See page 152 for service ratings and contact sizes.

† AS Aquacon version - uses an SJT (38999 type) pattern with size 12 contacts. See how to order page 156.



Aquacon

E

# AJ Aquacon

## Insert Arrangements

Front face of pin inserts illustrated

38999



Insert Arrangement	20-2	20-16	20-35	20-39		20-41
Service Rating	M	II	M	I		I
Number of Contacts	65	16	79	37	2	41
Contact Size	22	16	22D	20	16	20



Insert Arrangement	22-2	22-21	22-32	22-35	22-55
Service Rating	M	II	I	M	I
Number of Contacts	85	21	32	100	55
Contact Size	22	16	20	22D	20



Insert Arrangement	24-19†	24-24†		24-35	24-61
Service Rating	I	I		M	I
Number of Contacts	19	12	12	128	61
Contact Size	12	16	12	22D	20

See page 152 for service ratings and contact sizes.

† AS Aquacon version - uses an SJT (38999 type) pattern with size 12 contacts. See how to order page 156.



III  
II  
I  
SJT  
Access

Aquacon

Aquacon

E

1.	2.	3.	4.	5.	6.
Connector & Shell Style	Contact Type	Shell Size – Insert Arrangement	Contact Configuration	Insert Rotation	Special Variation
AJ6	R -	20-41	S	A	(445)

### AQUACON IMMERSIBLE CONNECTORS

		Aquacon with JT (38999 Type) Inserts	Aquacon with SJT (38999 Type) inserts- size 12 contacts only
CONNECTOR TYPE & STYLE	Receptacle Crimp	Jam Nut Receptacle AJ7	AS7
	Plugs	Straight Plug AJ6	AS6
	Hermetic	Jam Nut Receptacle AJ7	AS7
	Square Flange AJ0		

Fused compression glass sealed inserts. Leakage rate less than 1.0x10<sup>-6</sup> cc/sec at 15 psi differential; with interfacial seal.

## 2. CONTACT TYPE

### Receptacle

C	Non-Removable Solder Termination
R	Removable Crimp Termination
H	Hermetic (Glass Seal) Solder Termination (Receptacles only)

### Plug

C	Non-Removable Solder Termination
---	----------------------------------

## 5. ALTERNATE POSITIONING

Alternate positioning of Aquacon Series is achieved by a rotation of the master key/keyway, relative to the insert, as part of the shell manufacturing operation.

Recommended practice is to use alternate position inserts only when necessary.

### AQUACON MASTER KEY/KEYWAY ROTATION

Shell Size	AB Angle of Rotation (Degrees)				
	Normal	A	B	C	D
8	100	82			118
10	100	86	72	128	114
12	100	80	68	132	120
14	100	79	66	134	121
16	100	82	70	130	118
18	100	82	70	130	118
20	100	82	70	130	118
22	100	85	74	126	115
24	100	85	74	126	115

## 3. SELECT A SHELL SIZE & INSERT ARRANGEMENT SEE PAGES 2-5

Shell Size & Insert Arrangements are on pages 2-5. First number represents Shell Size, second number is the Insert Arrangement.

## 4. CONTACTS

P	Pin Contacts
S	Socket Contacts

Hermetics are available only in pin contacts.

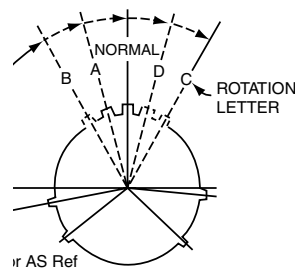

LATIVE POSSIBLE POSITION OF ROTATED MASTER KEYWAY (FACE OF AJ or AS RECEPTACLE SHOWN)

## 6. SPECIAL VARIATIONS

(168)	Rear Accessory Thread for Non-Hermetic Jam Nut Receptacle only.
(445)	Hex Coupling and Rear Accessory Threads for Straight Plug only.

Consult Amphenol Aerospace for other options and special variations available. See how to order protection caps on page 161.

# AJ6 / AS6 Aquacon

## Straight Plug

PART NUMBER BUILDER Page 156

Commercial  
AJ6X-  
AS6X-

38999

III  
II  
I  
SJT  
Access  
Aquacon

Aquacon



AJ6X-XX-XXX(445)



AS6X-XX-XXX(445)

AJ Aquacons use JT (38999 type) inserts that incorporate contact sizes 22D, 22M, 22, 20 or 16. AS Aquacons use SJT (38999 type) inserts that incorporate size 12 contacts

Shell Size	F Dia. +.000 -.005	L Max. (AJ)	L1 Max. (AS)	M ±.010	P Thread Class 2B	S Hex ±.016	V Thread Class 2A UNEF
8	.477	1.067	1.430	.360	.750-20 UNEF	.875	.5625-24
10	.602	1.067	1.430	.360	.875-20 UNEF	1.000	.6875-24
12	.727	1.062	1.430	.360	1.000-20 UNEF	1.125	.8125-20
14	.852	1.062	1.430	.360	1.125-18 UNEF	1.250	.9375-20
16	.977	1.062	1.430	.360	1.250-18 UNEF	1.375	1.0625-18
18	1.102	1.062	1.430	.360	1.375-18 UNEF	1.500	1.1875-18
20	1.227	1.312	1.680	.610	1.500-18 UNEF	1.625	1.3125-18
22	1.352	1.312	1.680	.610	1.625-18 UNEF	1.750	1.4375-18
24	1.477	1.312	1.680	.610	1.750-18 UNS	1.875	1.5625-18

All dimensions for reference only.

# AJ7H / AS7H Aquacon

## Hermetic Jam Nut Receptacle

38999

PART NUMBER BUILDER Page 156

Commercial  
AJ7H-  
AS7H-



AJ7H-XX-XXX(XXX)



AS7H-XX-XXX(XXX)

AJ Aquacons use JT (38999 type) inserts that incorporate contact sizes 22D, 22M, 22, 20 or 16. AS Aquacons use SJT (38999 type) inserts that incorporate size 12 contacts

Shell Size	A Thread Class 2A	G Dia.	H +.000 -.000	L ±.010 (Hermetic AJ)	L1 +.000 -.010 (Hermetic AS)	M	S Hex ±.016	X Bulkhead Thickness	X1 Bulkhead Thickness
								(AJ)	(AS)
8	.750-20 UNEF	1.125	.700	1.125	1.500	.125	.938	.03 – .31	.06 – .72
10	.875-20 UNEF	1.250	.825	1.125	1.500	.125	1.062	.03 – .31	.06 – .72
12	1.000-20 UNEF	1.406	.950	1.125	1.500	.125	1.188	.03 – .31	.06 – .72
14	1.125-18 UNEF	1.531	1.075	1.125	1.500	.125	1.312	.03 – .31	.06 – .72
16	1.250-18 UNEF	1.654	1.200	1.125	1.500	.125	1.438	.03 – .31	.06 – .72
18	1.375-18 UNEF	1.844	1.325	1.125	1.500	.125	1.562	.03 – .31	.06 – .72
20	1.500-18 UNEF	2.000	1.450	1.250	1.500	.188	1.688	.03 – .38	.06 – .65
22	1.625-18 UNEF	2.125	1.575	1.250	1.500	.188	1.812	.03 – .38	.06 – .65
24	1.750-18 UNS	2.250	1.700	1.250	1.500	.188	2.000	.03 – .38	.06 – .65

All dimensions for reference only.

# AJ7 / AS7 Aquacon

## Jam Nut Receptacle

PART NUMBER BUILDER Page 156

Commercial

AJ7X-  
ASJX-



AJ7X-XX-XXX(168)



ASJX-XX-XXX(168)

AJ Aquacons use JT (38999 type) inserts that incorporate contact sizes 22D, 22M, 22, 20 or 16. AS Aquacons use SJT (38999 type) inserts that incorporate size 12 contacts

Shell Size	A Thread Class 2A	F +.000 -.005	G Dia.	H +.000 -.005	L ±.010 (AJ)	L1 +.000 -.010 (AS)	M	S Hex ±.016	V Thread Class 2A UNEF	X Bulkhead Thickness	X1 Bulkhead Thickness
										(AJ)	(AS)
8	.750-20 UNEF	.477	1.125	.700	1.484	1.750	.125	.938	.5625-24	.03 - .31	.03 - .58
10	.875-20 UNEF	.602	1.250	.825	1.484	1.750	.125	1.062	.6875-24	.03 - .31	.03 - .58
12	1.000-20 UNEF	.727	1.406	.950	1.484	1.750	.125	1.188	.8125-20	.03 - .31	.03 - .58
14	1.125-18 UNEF	.852	1.531	1.075	1.484	1.750	.125	1.312	.9375-20	.03 - .31	.03 - .58
16	1.250-18 UNEF	.977	1.654	1.200	1.484	1.750	.125	1.438	1.0625-18	.03 - .31	.03 - .58
18	1.375-18 UNEF	1.102	1.844	1.325	1.484	1.750	.125	1.562	1.1875-18	.03 - .31	.03 - .58
20	1.500-18 UNEF	1.227	2.000	1.450	1.609	1.750	.188	1.688	1.3125-18	.03 - .38	.03 - .50
22	1.625-18 UNEF	1.352	2.125	1.575	1.609	1.750	.188	1.812	1.4375-18	.03 - .38	.03 - .50
24	1.750-18 UNS	1.477	2.250	1.700	1.609	1.750	.188	2.000	1.5625-18	.03 - .38	.03 - .50

All dimensions for reference only.

38999

- III
- II
- I
- SJT
- Access
- Aquacon

Aquacon

E

# AJOH Aquacon

## Hermetic Square Flange Receptacle

38999

PART NUMBER BUILDER Page 156

Commercial  
AJOH-



The Aquacon Hermetic Square Flange Receptacle is available in AJ style only which incorporates contact sizes 22D, 22M, 22, 20 or 16.

Shell Size	A Thread Class 2A	F Dia. +.000 -0.001	G ±.030	L	M	R	S	T ±.005	Packing Pos I Part Number	Packing Pos II Part Number
8	.750-20 UNEF	.685	.344	1.125	.125	.719	.938	.128	10-90351-15	10-90351-14
10	.875-20 UNEF	.810	.344	1.125	.125	.812	1.031	.128	10-90351-17	10-90351-16
12	1.000-20 UNEF	.935	.344	1.125	.125	.906	1.125	.128	10-90351-19	10-90351-18
14	1.125-18 UNEF	1.060	.344	1.125	.125	.969	1.219	.128	10-90351-21	10-90351-20
16	1.250-18 UNEF	1.185	.344	1.125	.125	1.062	1.312	.128	10-90351-23	10-90351-22
18	1.375-18 UNEF	1.248	.344	1.125	.125	1.156	1.438	.128	10-90351-24	10-90351-24
20	1.500-18 UNEF	1.373	.375	1.219	.188	1.250	1.562	.128	10-90351-26	10-90351-26
22	1.625-18 UNEF	1.498	.375	1.219	.188	1.375	1.688	.147	10-90351-28	10-90351-28
24	1.750-18 UNS	1.623	.375	1.219	.188	1.500	1.812	.147	10-90351-29	10-90351-29

All dimensions for reference only.





### RECEPTACLE PROTECTION CAP 10-377664-XX

Shell Size	P Thread Class 2A	R Ref.	S Hex +.005 -.010
8	.750-20 UNEF	1.010	.875
10	.875-20 UNEF	1.155	1.000
12	1.000-20 UNEF	1.299	1.125
14	1.125-18 UNEF	1.443	1.250
16	1.250-18 UNEF	1.588	1.375
18	1.375-18 UNEF	1.732	1.500
20	1.500-18 UNEF	1.876	1.625
22	1.625-18 UNEF	2.021	1.750
24	1.750-18 UNS	2.165	1.875



### PLUG PROTECTION CAP 10-399623-XX

Shell Size	A Dia. Max.	B +.031 -.000	D Thread Class 2A
8	.771	.625	.750-20 UNEF
10	.898	.625	.875-20 UNEF
12	1.010	.625	1.000-20 UNEF
14	1.137	.625	1.125-18 UNEF
16	1.264	.625	1.250-18 UNEF
18	1.392	.625	1.375-18 UNEF
20	1.519	.688	1.500-18 UNEF
22	1.646	.688	1.625-18 UNEF
24	1.744	.688	1.750-18 UNS

All dimensions for reference only.

### HOW TO ORDER PROTECTION CAPS

Protection Cap Style	Cap Size (Correlates to Connector Shell Size)
For Receptacle Connector	10-377664 - 20
For Plug Connector	10-399623 - 20

38999

III  
II  
I  
SJT  
Access

Aquacon

Aquacon

E

# Aquacon Series

## Installation Instructions, Application Tools

38999

### MOLDING

Suggested method of assembly to cable for Aquacon plugs and cable connecting receptacles is molding. The mold sealing diameter has been designed to use a common mold for both plug and receptacle in a given shell size.

### SEALING

In a mated condition, the red visual mating indicator band must be fully concealed by the plug coupling nut to assure a reliable, pressure rated sealed joint. Failure to fully tighten the coupling nut may allow leakage through the main joint seal. The red visual mating indicator is so located that only a full and proper mating of the plug and receptacle will cause the indicator to be fully hidden by the plug coupling nut.



Red Visual Mating Indicator Band

### MOUNTING SURFACES

The integrity of an "O" ring hydrostatic shell is dependent upon the flatness of the surface on which the receptacle is mounted. Surface finishes of 23 microns or less are recommended for "O" ring sealing areas when jam nut or through bulkhead receptacles are mounted.

MOUNTING CUTOUTS



Rear mount jam nut

Shell Size	B +.010 -.000	R +.010 -.000
8	.705	.759
10	.830	.884
12	.955	1.007
14	1.080	1.134
16	1.205	1.259
18	1.330	1.384
20	1.455	1.507
22	1.580	1.634
24	1.705	1.759

### RECEPTACLE "O" RING RACKING REQUIREMENTS ARP 568 UNIFORM DASH NUMBER

Shell Size	Main Joint Seal	Shell to Mounting Surface Seal
		Jam Nut
8	ARP-014	ARP-019
10	ARP-016	ARP-021
12	ARP-018	ARP-023
14	ARP-020	ARP-025
16	ARP-022	ARP-027
18	ARP-024	ARP-029
20	ARP-026	ARP-030
22	ARP-028	ARP-031
24	ARP-029	ARP-032

### CONVERSION TABLE SALT WATER DEPTH TO HYDROSTATIC PRESSURE

Salt-Water Depth in Feet	Pounds per Sq. Inch	Salt-Water Depth in Feet	Pounds per Sq. Inch
10	4	2,000	890
25	11	2,500	1,113
50	22	3,000	1,335
75	33	4,000	1,780
100	45	5,000	2,225
200	89	6,000	2,670
250	111	7,000	3,115
300	134	7,500	3,338
400	178	8,000	3,560
500	223	9,000	4,005
600	267	10,000	4,450
750	334	15,000	6,675
800	356	20,000	8,900
1,000	445	25,000	11,125

### APPLICATION TOOLING

Contact Size	Crimping Tool	Positioner	Insertion Tool*	Removal Tool*	Sealing Plug*	Color Code	Reference Publication
22M	M22520/2-01	M22520/2-09†	11-8674-24††	11-8675-24††	10-405996-22	Black	L-624
22D	M22520/2-01	M22520/2-09†	11-8674-24††	11-8675-24††	10-405996-22	Black	
22	M22520/2-01	M22520/2-09†	11-8674-22††	11-8675-22††	10-405996-22	Black	
20	M22520/1-01	M22520/1-04	11-8674-20††	11-8675-20††	10-405996-20	Red	
16	M22520/1-01	M22520/1-04	11-8674-16††	11-8675-16††	10-405996-16	Blue	
12	M22520/1-01	M2520/1-04	11-8674-12††	11-8675-12††	10-405996-12	Yellow	

\* Amphenol Part Numbers

† Pin only. Use M22520/2-06 for socket contacts.

†† Contact Daniels Manufacturing Co. or Astro Tool Corp. for availability.

\*\* Available online at [www.amphenol-aerospace.com/termination\\_instructions](http://www.amphenol-aerospace.com/termination_instructions)

### CONTACT INSTALLATION

#### WIRE AND CABLE PREPARATION

1. Cut wire or cable to desired length. Strip insulation from end of wire in accordance with the following table. Hot wire stripping methods are recommended. Avoid nicking or cutting wire strands.

#### WIRE STRIP LENGTH IN INCHES

Contact Type	Contact Size					
	22M	22D	22	20	16	12
Solder	1/8	-	1/8	5/32	5/32	
Crimp	1/8 - 5/32			7/32 - 1/4		

#### SOLDER CONTACT TERMINATION

1. Clean conductors and pre-tin with a good grade 60/40 tin-lead solder to 1/16 inch.
2. Pre-tin contact solder well.
3. With connector in a suitable holding device, solder wells facing operator, and the cutaway portion of the wells up, insert pre-tinned conductor into contact well. Apply heat to closed side of wire well to make joint. Remove heat and allow joint to cool.
4. A resistance soldering unit of approximately 125 watts is recommended. If a soldering iron is used, do not exceed 20 watts for size 22M, 22D and 22 contacts; 80 watts for size 20; and 150 watts for size 16 and 12 contacts.
5. Wipe or brush excess flux from terminations.

#### CRIMP CONTACT TERMINATION

1. Select proper crimping tool and positioner from Application Tooling table on previous page.
2. Position wire in wire well. Wire must be visible in the inspection hole provided.
3. With the wire in place, insert the contact fully into the crimping tool. Squeeze the crimping tool handles to the full extent of their travel. The recommended crimping tools are the "full cycling" type and will not release until a complete crimp is made. Release pressure on handles and remove the completed crimped contact/wire assembly.

#### CONTACT INSERTION

1. Select proper insertion tool from Application Tooling table on previous page.
2. With contact/wire assembly properly positioned in the insertion tool, push forward, directly in line with the grommet hole, until the contact is felt to snap into place.
3. Remove insertion tool.  
All unused contact positions must be filled with uncrimped contacts. In addition, sealing plugs (see Application Tooling table) should be inserted in all unused grommet holes.

#### CONTACT REMOVAL

1. Select proper removal tool from Application Tooling table on previous page.
2. Carefully insert removal tool until contact to be removed is released. Aquacon contacts are rear release, rear removable.
3. Remove contact.

# Accessories and Tools for MIL-DTL-38999 Series III, II, I and SJT

## F



### TABLE OF CONTENTS FOR SECTION F

Accessories for MIL-DTL-38999 Connectors	
MIL-DTL-38999 Backshells . . . . .	165
(Refers to Backshell Section from Amphenol PCD)	
Protection Caps for Series III . . . . .	166, 167
Dummy Receptacles for Series III . . . . .	168
Cable Clamps for Series III. . . . .	169
Accessories for Series III Breakaway Connectors . . . . .	170
Protection Caps for Series II . . . . .	171, 172
Strain Reliefs for Series II, I . . . . .	173
Protection Caps for Series I . . . . .	174, 175
Strain Reliefs for Series I . . . . .	176
Protection Caps for SJT. . . . .	177
Dummy Receptacles & Cable Clamps for SJT. . . . .	178
Header Assemblies for Series III, II, I . . . . .	179, 180
Application Tools (Crimp, Insertion, Removal) for Series III, II, I, SJT . . . . .	181
Assembly Instructions for Series III, II, I, SJT . . . . .	182, 183

Amphenol offers a full range of accessories that are designed to enhance the performance of Amphenol 38999 connectors, both military and non-military.

Backshells are an integral part of any circular connector when it comes to reliable cable connections. Amphenol divisions team up globally to provide a very large assortment of backshells for use with 38999 Series of connectors, as well as other circular series.

This Accessories and Tools section covers what is offered from Amphenol Aerospace, Sidney, NY. For MIL-DTL-38999 Series III, II, I and SJT (reference table of contents on preceding page).

**38999**

III

II

I

SJT

Access

Aquacon

**Accessories**

The section of this catalog called "Backshells" covers the backshell and adapters that are provided through the Amphenol PCD/Amphenol India divisions. Please refer to this section for:

- Backshells for Connector Family "L", which includes MIL-DTL-38999 Series III and Series IV
- Backshells for Connector Family "K", which includes MIL-DTL-38999 Series I and Series II
- Backshells for Connector Family "J", which includes MIL-DTL-24682 (Matrix, Series 2), MIL-DTL-5015 (Matrix, MS3400 Series), MIL-DTL-83723 (Series I & III), MIL-DTL-81703 (Series III)



The variety of types of backshells and adapters covered in the Backshells section of this catalog include:

- Non-environmental backshells
- Environmental backshells
- Non-environmental EMI/RFI backshells
- Environmental EMI/RFI backshells
- Shrink boot adapters
- Crimp ring adapters
- Band lock adapters
- Pre-shield adapters

For more information contact:

Amphenol Aerospace: [www.amphenol-aerospace.com](http://www.amphenol-aerospace.com) (phone: 800-678-0141)  
or visit [www.backshellworld.com](http://www.backshellworld.com) or email: [sales@backshellworld.com](mailto:sales@backshellworld.com)

# MIL-DTL-38999, Series III TV Receptacle Protection Cap

38999

III

II

I

SJT

Access

Aquacon

Accessories



\* To complete order number, add shell size and suffix number.  
For example, shell size 11 with olive drab cadmium nickel base, 10-552943-119

Inches				Millimeters			
Shell Size	A Thread Class 2B 0.1P-0.3L-TS	B Dia. Max.	D Dia. +.010 - .000	Shell Size	MS Shell Size Code	B Dia. Max.	D Dia. +.25 - .00
9	.6250	.875	.703	9	A	22.23	17.86
11	.7500	1.000	.844	11	B	25.40	21.44
13	.8750	1.125	1.016	13	C	28.58	25.81
15	1.0000	1.250	1.141	15	D	31.75	28.98
17	1.1875	1.438	1.266	17	E	36.53	32.16
19	1.2500	1.500	1.391	19	F	38.10	35.33
21	1.3750	1.625	1.516	21	G	41.28	38.51
23	1.5000	1.750	1.641	23	H	44.45	41.68
25	1.6250	1.875	1.766	25	J	47.63	44.86

All dimensions for reference only.

## TV SERIES III MS METAL PROTECTION CAPS

Shell Size	MS Shell Size Code	MS Receptacle Protection Cap
9	A	D38999/33W9X*
11	B	D38999/33W11X*
13	C	D38999/33W13X*
15	D	D38999/33W15X*
17	E	D38999/33W17X*
19	F	D38999/33W19X*
21	G	D38999/33W21X*
23	H	D38999/33W23X*
25	J	D38999/33W25X*

\* To complete order number, replace X with applicable letter as follows:  
R - designates eyelet type  
N - designates washer type

MS metal protection caps are supplied with service class W which designates corrosion resistant olive drab cadmium plate aluminum.  
Consult Amphenol Aerospace for more detailed information on ordering MS Metal protection caps.

Finish	10-No Suffix
Olive Drab, Cadmium, Nickel base	-XX9
Electroless Nickel	-XXG

Consult Amphenol Aerospace for availability of stainless steel protection caps.

## TV SERIES III PLASTIC PROTECTION CAPS

Shell Size	Receptacle
9	10-70500-10
11	10-70500-12
13	10-70500-14
15	10-70500-16
17	10-70500-19
19	10-70500-20
21	10-70500-22
23	10-70500-24
25	10-70524-1

F

# MIL-DTL-38999, Series III TV Plug Protection Cap

38999

III  
II  
I  
SJT  
Access  
Aquacon

Accessories



\* To complete order number, add shell size and suffix number.  
For example, shell size 11 with olive drab cadmium nickel base, 10-552944-119

Inches				Millimeters			
Shell Size	A Thread Class 2B 0.1P-0.3L-TS	D Dia. +.010 -.000	N Dia. Max.	Shell Size	MS Shell Size Code	D Dia. +.25 - .00	N Dia. Max.
9	.6250	.516	.895	9	A	13.11	22.73
11	.7500	.641	1.000	11	B	16.28	25.40
13	.8750	.766	1.171	13	C	19.46	29.74
15	1.0000	.891	1.299	15	D	22.63	32.99
17	1.1875	1.016	1.436	17	E	25.81	36.47
19	1.2500	1.141	1.543	19	F	28.98	39.19
21	1.3750	1.266	1.670	21	G	32.16	42.42
23	1.5000	1.343	1.787	23	H	34.11	45.39
25	1.6250	1.516	1.914	25	J	38.51	48.62

All dimensions for reference only.

## TV SERIES III MS METAL PROTECTION CAPS

Shell Size	MS Shell Size Code	MS Plug Protection Cap
9	A	D38999/32W9X*
11	B	D38999/32W11X*
13	C	D38999/32W13X*
15	D	D38999/32W15X*
17	E	D38999/32W17X*
19	F	D38999/32W19X*
21	G	D38999/32W21X*
23	H	D38999/32W23X*
25	J	D38999/32W25X*

\* To complete order number, replace X with applicable letter as follows:

R - designates eyelet type

N - designates washer type

MS metal protection caps are supplied with service class W which designates corrosion resistant olive drab cadmium plate aluminum.

Consult Amphenol Aerospace for more detailed information on ordering MS Metal protection caps.

Finish	10-No Suffix
Olive Drab, Cadmium, Nickel base	-XX9
Electroless Nickel	-XXG

Consult Amphenol Aerospace for availability of stainless steel protection caps.

## TV SERIES III PLASTIC PROTECTION CAPS

Shell Size	Plug
9	10-70506-14
11	10-70506-16
13	10-70500-18
15	10-70500-20
17	10-70500-22
19	10-70500-24
21	10-70524-1
23	10-70506-28
25	10-70500-28

# MIL-DTL-38999, Series III TV Dummy Receptacle

38999

III

II

I

SJT

Access

Aquacon

Accessories

PART NUMBER REFERENCE.  
SEE NOTE BELOW TO COMPLETE.

\*10-553974-XXX



\* To complete order number, add shell size and suffix number.  
For example, shell size 11 with olive drab cadmium nickel base, 10-553974-119

Inches

Shell Size	MS Shell Size Coded	B Thread 0.1P-0.3L-TS (Plated)	M +.020 -.000	R <sup>1</sup>	R <sup>2</sup>	S ±.010	T ±.008 -.006	W ±.010	TT ±.008 -.006
9	A	.6250	.822	.719	.594	.938	.128	.098	.216
11	B	.7500	.822	.812	.719	1.031	.128	.098	.194
13	C	.8750	.822	.906	.812	1.125	.128	.098	.194
15	D	1.0000	.822	.969	.906	1.219	.128	.098	.173
17	E	1.1875	.822	1.062	.969	1.312	.128	.098	.194
19	F	1.2500	.822	1.156	1.062	1.438	.128	.098	.194
21	G	1.3750	.791	1.250	1.156	1.562	.128	.125	.194
23	H	1.5000	.791	1.375	1.250	1.688	.154	.125	.242
25	J	1.6250	.791	1.500	1.375	1.812	.154	.125	.242

Millimeters

Finish	10-No Suffix
Olive Drab, Cadmium, Nickel Base	-XX9
Electroless Nickel	-XXG

Shell Size	MS Shell Size Coded	M +.51 -.00	R <sup>1</sup>	R <sup>2</sup>	S ±.25	T +.20 -.15	W ±.25	TT +.20 -.15
9	A	20.88	18.26	15.09	23.83	3.25	2.49	5.49
11	B	20.88	20.62	18.26	26.19	3.25	2.49	4.93
13	C	20.88	23.01	20.62	28.58	3.25	2.49	4.93
15	D	20.88	24.61	23.01	30.96	3.25	2.49	4.93
17	E	20.88	26.97	24.61	33.32	3.25	2.49	4.93
19	F	20.88	29.36	26.97	36.53	3.25	2.49	4.93
21	G	20.09	31.75	29.36	39.67	3.25	3.18	4.93
23	H	20.09	34.93	31.75	42.88	3.91	3.18	6.15
25	J	20.09	38.10	34.93	46.02	3.91	3.18	6.15

All dimensions for reference only.

Designates true position dimensioning.



# MIL-DTL-38999, Series III TV Cable Clamps

38999

III

II

I

SJT

Access

Aquacon

Accessories

**Straight Style**  
\*10-552681-XXX metal coupling

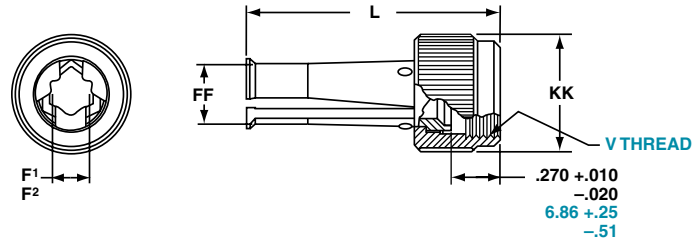

**90 Degree Elbow Style**  
\*10-552682-XXX metal coupling



\* To complete order number, see suffix chart below. Examples:  
Clamp with metal coupling nut for shell size 11 with olive drab  
cadmium nickel base, 10-552681-119.

Inches

Shell Size	MS Shell Size Code	F <sup>1</sup> Min. Dia. Cable	F <sup>2</sup> Max. Dia. Cable	L Max.	U Max.	FF Dia. Max.	KK Dia. Max.	LL Max.
9	A	.094	.203	1.431	.656	.347	.629	1.015
11	B	.141	.250	1.431	.688	.394	.756	1.062
13	C	.172	.323	1.431	.750	.467	.883	1.125
15	D	.203	.422	1.431	.859	.566	1.011	1.328
17	E	.234	.500	1.431	.937	.644	1.138	1.392
19	F	.265	.562	1.431	1.000	.706	1.265	1.453
21	G	.297	.625	1.492	1.062	.769	1.393	1.609
23	H	.328	.703	1.492	1.141	.847	1.488	1.656
25	J	.359	.765	1.492	1.203	.909	1.616	1.719

Millimeters

Finish	10-No Suffix	Shell Size	MS Shell Size Code	F <sup>1</sup> Min. Dia. Cable	F <sup>2</sup> Max. Dia. Cable	L Max.	U Max.	V Thread Metric	FF Dia. Max.	KK Dia. Max.	LL Max.
Olive Drab, Cadmium Nickel Base	-XX9	9	A	2.39	5.16	36.35	16.66	M12X1-6H	8.81	15.98	25.78
		11	B	3.58	6.35	36.35	17.48	M15X1-6H	10.01	19.20	26.97
		13	C	4.37	8.20	36.35	19.05	M18X1-6H	11.86	22.43	28.58
		15	D	5.16	10.72	36.35	21.82	M22X1-6H	14.38	25.68	33.73
		17	E	5.94	12.70	36.35	23.80	M25X1-6H	16.36	28.91	35.36
		19	F	6.73	14.27	36.35	25.40	M28X1-6H	17.93	32.13	36.91
		21	G	7.54	15.88	37.90	26.97	M31X1-6H	19.53	35.38	40.87
		23	H	8.83	17.86	37.90	28.98	M34X1-6H	21.51	37.80	42.06
		25	J	9.12	19.43	37.90	30.56	M37X1-6H	23.09	41.05	43.66



# 38999, Series III TV Breakaway Fail Safe Backshells, Dummy Contacts, Wire Combs

38999

III

II

I

SJT

Access

Aquacon

Accessories

Amphenol offers a full range of accessories that are designed to enhance the performance of Amphenol Breakaway connectors.

## Low Profile Backshells in shell size 25 with the following features:

- Olive drab cadmium finish
- 90 degree termination
- Low profile design with three heights ranging from 1.010 to 1.660
- Rear access covers to help ease harness assembly and repairability
- Amphenol part numbers: 10-640000-XXX



BACKSHELLS ARE OFFERED FOR USE WITH BREAKAWAY FAIL SAFE CONNECTORS IN THREE HEIGHTS

## DUMMY CONTACTS

- Available in size 12 and size 8
- Provide a cost effective alternative for sealing unused contact cavities
- Size 8 part number: T3-4008-59P
- Size 12 part number: T3-4012-59P

## WIRE COMBS

- Available for the 25-20 insert pattern to help to stabilize and prevent contact side loading
- Amphenol part number: 21-33626-XXX

For information on how to order these accessory products for Breakaway Fail Safe connectors, consult Amphenol Aerospace.



ACCESSORY PRODUCTS FOR BREAKAWAY CONNECTORS:  
DUMMY CONTACTS AND WIRE COMBS

F

# MIL-DTL-38999, Series II JT Plug Protection Cap

38999

III  
II  
I  
SJT  
Access  
Aquacon

Accessories

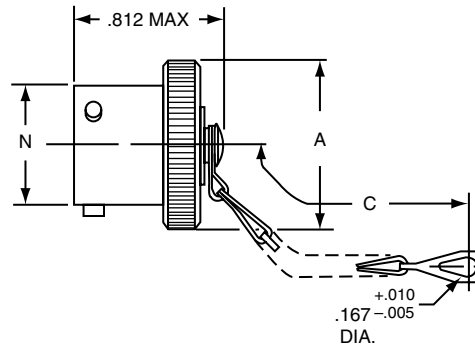

**\*10-547138-XXX (MS27510XXXC)**



**\*10-241853-XXX (MS27510XXXA)**

For MS stamping identification, accessories must be ordered by MS part number. If ordered by 10- part number, they will be stamped with said number.

\* To complete order number, add shell size and suffix number. For example, shell size 10 with cadmium plate, nickel base would be 10-241853-107, MS27510A10C or MS27510A10A.

Shell Size	A Dia. Max.	A' Dia. Max.	B +.000 - .016	C Approx.	N Dia. +.001 - .005
8	.719	.703	.563	3.000	.473
10	.844	.828	.680	3.000	.590
12	1.000	.984	.859	3.500	.750
14	1.125	1.109	.984	3.500	.875
16	1.250	1.234	1.108	3.500	1.000
18	1.375	1.359	1.233	3.500	1.125
20	1.500	1.484	1.358	4.000	1.250
22	1.625	1.609	1.483	4.000	1.375
24	1.750	1.734	1.610	4.000	1.500

All dimensions for reference only.

Finish	10-Number Suffix	MS Number Suffix with chain	MS Number Suffix without chain
Chromate Treat	-XX0		
Anodic Coating	-XX5	CXXC	CXXA
Cadmium Plate Nickel Base	-XX7	AXXC	AXXA
Olive Drab, Cadmium, Nickel Base	-XX9	BXXC	BXXA
Electroless Nickel	-XXG	FXXC	FXXA

## SERIES II JT PLASTIC PROTECTION CAPS

Shell Size	Plug
8	10-70500-10
9	10-70506-14
10	10-70506-14
11	10-70506-16
12	10-70506-16
13	10-70506-18
14	10-70506-18
15	10-70506-20
16	10-70506-20
17	10-70506-22
18	10-70506-22
19	10-70506-24
20	10-70506-24
21	10-70576-24
22	10-70576-24
23	10-70506-28
24	10-70506-28
25	10-558651-25



# MIL-DTL-38999, Series II JT Receptacle Protection Cap

38999

III  
II  
I  
SJT  
Access  
Aquacon

Accessories



**\*10-547136-XXX (MS27511XXXQ)**



**\*10-241856-XXX (MS27511XXXA)**



**\*10-241802-XXX**

For MS stamping identification, accessories must be ordered by MS part number. If ordered by 10- part number, they will be stamped with said number.

\* To complete order number, add shell size and suffix number.

For example, shell size 10 with cadmium plate, nickel base would be 10-241802-107, MS27511A10C, MS27511A10A

Shell Size	A Dia. Max.	C Approx.	D +.010 -0.000
8	.719	3.000	.891
10	.844	3.000	1.016
12	1.000	3.500†	1.141
14	1.125	3.500	1.266
16	1.250	3.500	1.391
18	1.375	3.500	1.516
20	1.500	4.000	1.641
22	1.625	4.000	1.766
24	1.750	4.000	1.891

† 3.000 for MS27511  
All dimensions for reference only.

## SERIES II JT PLASTIC PROTECTION CAPS

Shell Size	Receptacle
8	10-70506-10S
9	10-70500-10
10	10-70506-12
11	10-70500-12
12	10-70506-14
13	10-70500-14
14	10-70506-16
15	10-70500-16
16	10-70506-18
17	10-70500-18
18	10-70506-20
19	10-70500-20
20	10-70506-22
21	10-70500-22
22	10-70506-24
23	10-70500-24
24	10-70576-24
25	10-70506-28

Finish	10-Number Suffix	MS Number Suffix with chain	MS Number Suffix without chain
Chromate Treat	-XX0		
Anodic Coating	-XX5	CXXC	CXXA
Cadmium Plate Nickel Base	-XX7	AXXC	AXXA
Olive Drab, Cadmium, Nickel Base	-XX9	BXXC	BXXA
Electroless Nickel	-XXG	FXXC	FXXA

F

MIL-DTL-38999, Series II JT  
MIL-DTL-38999, Series I LJT  
**Strain Relief (Crimp Type)**

38999

III

II

I

SJT

Access

Aquacon

Accessories



**\*10-405982-XXX (MS27506XXX-2 REFERENCE M85049/49)**

For MS stamping identification, accessories must be ordered by MS part number.  
If ordered by 10-part number, they will be stamped with said number.  
\*To complete order number, add shell size and suffix number.

Finish	10-Number Suffix	MS27506 Suffix	M85049/49 Suffix
Chromate Treat	-XX0		NA
Anodic Coating	-XX5	CXX-2	(-2-XXA)
Cadmium Plate Nickel Base	-XX7	AXX-2	NA
Olive drab, Cadmium, Nickel base	-XX9	BXX-2	(-2-XXW)
Electroless Nickel	-XXG	FXX-2	(-2-XXN)

For example: Shell size 10 with cadmium plate, nickel base would be 10-405982-107 or M85049/49-2-10W

Shell Size	B Dia. +.010 -.025	G Max.	L Max.	Y Thread (Modified)		BB Dia. +.000 -.011	Screw Size
				Size Class 2B	Modified Minor Dia.		
8	.125	.775	.984	.4375-28UNEF	.399 – .405	.250	6-32UNC
10	.188	.837	.984	.5625-24UNEF	.524 – .529	.312	6-32UNC
12	.312	.963	.984	.6875-24UNEF	.649 – .654	.438	6-32UNC
14	.375	1.087	1.234	.8125-20UNEF	.766 – .771	.562	6-32UNC
16	.500	1.150	1.234	.9375-20UNEF	.891 – .896	.625	6-32UNC
18	.625	1.400	1.234	1.0625-18UNEF	1.002 – 1.007	.750	8-32UNC
20	.625	1.400	1.234	1.1875-18UNEF	1.135 – 1.140	.750	8-32UNC
22	.750	1.587	1.359	1.3125-18UNEF	1.252 – 1.257	.938	8-32UNC
24	.800	1.681	1.281	1.4375-18UNEF	1.377 – 1.382	1.000	8-32UNC

All dimensions for reference only.  
Note: For solder type cable clamp 10-241055-XXX (M85049/49) consult Amphenol Aerospace.

# MIL-DTL-38999, Series I LJT Plug Protection Cap

38999

- III
- II
- I
- SJT
- Access
- Aquacon

Accessories



\* To complete order number, add shell size and suffix number.  
For example, shell size 11 with cadmium plate, nickel base would be 10-421399-117, MS27501A11C, MS27501A11A.

Shell Size	B Dia. Ref	D Dia. Max.	M ±.250	N Dia. +.001 - .005
9	.180	.812	3.000	.572
11	.180	.938	3.000	.700
13	.180	1.062	3.500	.850
15	.180	1.188	3.500	.975
17	.180	1.312	3.500	1.100
19	.209	1.438	3.500	1.207
21	.209	1.562	4.000	1.332
23	.209	1.688	4.000	1.457
25	.209	1.812	4.000	1.582

## SERIES I LJT PLASTIC PROTECTION CAPS

Shell Size	Plug
8	10-70500-10
9	10-70506-14
10	10-70506-14
11	10-70506-16
12	10-70506-16
13	10-70506-18
14	10-70506-18
15	10-70506-20
16	10-70506-20
17	10-70506-22
18	10-70506-22
19	10-70506-24
20	10-70506-24
21	10-70576-24
22	10-70576-24
23	10-70506-28
24	10-70506-28
25	10-558651-25

Finish	10- Number Suffix	MS Number Suffix with chain	MS Number Suffix without chain
Chromate Treat	-XX0		
Anodic Coating	-XX5		
Cadmium Plate Nickel Base	-XX7	AXXC	AXXA
Olive Drab, Cadmium, Nickel Base	-XX9	BXXC	BXXA
Electroless Nickel	-XXG	FXXC	FXXA

All dimensions for reference only.

F

# MIL-DTL-38999, Series I LJT Receptacle Protection Cap

38999

III

II

I

SJT

Access

Aquacon

Accessories



\* 10-275197-XXX (MS27502XXXA)

\*10-427950-XXX

For MS stamping identification, accessories must be ordered by MS part number.  
If ordered by 10- part number, they will be stamped with said number.

\*To complete order number, add shell size and suffix number.

For example, shell size 11 with cadmium plate, nickel base would be 10-427406-117, MS27502A11C, MS27502A11A.

## SERIES I LJT PLASTIC PROTECTION CAPS

Shell Size	B Dia. +.010 -.000	D Dia. Max.	L Max.	L' Max	M ±.250
9	.703	.844	1.070	.844	3.000
11	.844	.969	1.070	.844	3.000
13	1.016	1.125	1.070	.844	3.500
15	1.141	1.250	1.070	.844	3.500
17	1.266	1.406	1.070	.844	3.500
19	1.391	1.500	1.070	.844	3.500
21	1.516	1.625	1.070	.844	4.000
23	1.641	1.750	1.070	.844	4.000
25	1.766	1.875	1.089	.875	4.000

Shell Size	Receptacle
8	10-70506-10S
9	10-70500-10
10	10-70506-12
11	10-70500-12
12	10-70506-14
13	10-70500-14
14	10-70506-16
15	10-70500-16
16	10-70506-18
17	10-70500-18
18	10-70506-20
19	10-70500-20
20	10-70506-22
21	10-70500-22
22	10-70506-24
23	10-70500-24
24	10-70576-24
25	10-70506-28

Finish	10-Number Suffix	MS Number Suffix with chain	MS Number Suffix without chain
Chromate Treat	-XX0		
Anodic Coating	-XX5	CXXC	CXXA
Cadmium Plate Nickel Base	-XX7	AXXC	AXXA
Olive Drab, Cadmium, Nickel Base	-XX9	BXXC	BXXA
Electroless Nickel	-XXG	FXXC	FXXA

All dimensions for reference only.

# MIL-DTL-38999, Series I LJT Strain Relief (Solder Type)

38999

- III
- II
- I
- SJT
- Access
- Aquacon

Accessories



**\*10-436792-XXX**

For military type cable clamp see MS27506 or M85049/49 on page 173.  
\*To complete order number, add shell size and suffix number.

Finish	10-Number Suffix
Chromate treat	-XX0
Anodic coating	-XX5
Cadmium Plate Nickel Base	-XX7
Olive Drab, Cadmium, Nickel Base	-XX9
Electroless Nickel	-XXG

For example: Shell size 11 with cadmium plate, nickel base would be 10-436792-117.

Shell Size	B Dia. +.010 -.025	L Max.	Y Thread Class 2B (Plated)	GG Max.	BB Dia. +.000 -.011
9	.125	.859	.4375-28 UNEF	.775	.250
11	.188	.859	.5625-24 UNEF	.837	.312
13	.312	.859	.6875-24 UNEF	.963	.438
15	.375	1.109	.8125-20 UNEF	1.087	.562
17	.500	1.109	.9375-20 UNEF	1.150	.625
19	.625	1.109	1.0625-18 UNEF	1.400	.750
21	.625	1.109	1.1875-18 UNEF	1.400	.750
23	.750	1.234	1.3125-18 UNEF	1.587	.938
25	.800	1.234	1.4375-18 UNEF	1.681	1.000

All dimensions for reference only.



### PLUG PROTECTION CAP



\*10-476801-XXX

### RECEPTACLE PROTECTION CAP



\*10-325943-XXX



\*10-476810-XXX

\* To complete order number, add shell size and suffix number. For example, shell size 10 with bright cadmium plated nickel base, 10-476810-107.

\* To complete order number, add shell size and suffix number. For example, shell size 10 with bright cadmium plated nickel base, 10-325943-107.

Plug Shell Size	D Dia. Max.	N Dia. +.001 - .005
8	.688	.473
10	.812	.590
12	.969	.750
14	1.094	.875
16	1.219	1.000
18	1.344	1.125
20	1.469	1.250
22	1.594	1.375
24	1.719	1.500

All dimensions for reference only

Receptacle Shell Size	DD Dia. Max.	L Max.
8	.734	.828
10	.844	.828
12	1.016	.828
14	1.141	.828
16	1.265	.828
18	1.391	.828
20	1.500	.828
22	1.625	.828
24	1.750	.859

### SJT

### PLASTIC PROTECTION CAPS

Protection Cap Finish	Suffix
Bright Cadmium Plated Nickel Base	XX7
Anodic Coating (Alumilite)	XX5
Chromate Treated (Iridite 14-2)	XX0
Olive Drab Cadmium Plate Nickel Base	XX9
Electroless Nickel Coating	XXG

Shell Size	Plug	Receptacle
8	10-70500-10	10-70506-10S
10	10-70500-14	10-70506-12
12	10-70500-16	10-70506-14
14	10-70500-18	10-70506-16
16	10-70500-20	10-70506-18
18	10-70500-22	10-70506-20
20	10-70500-24	10-70506-22
22	10-70524-1	10-70506-24
24	10-70506-28	10-70524-1

# SJT – Accessories

## Dummy Receptacle, Cable Clamp

38999

III

II

I

SJT

Access

Aquacon

Accessories

### DUMMY RECEPTACLE



\*10-476807-XXX

Dummy Receptacle Finish	Suffix
Bright Cadmium Plated Nickel Base	XX7
Anodic Coating (Alumilite)	XX5
Chromate Treated (Iridite 14-2)	XX0
Olive Drab Cadmium Plate Nickel Base	XX9
Electroless Nickel Coating	XXG

\* To complete order number, add shell size and suffix number. For example, shell size 10 with bright cadmium plated nickel base, 10-476807-107.

Dummy Receptacle Shell Size	D Dia. Max.	L Max.
8	.734	.828
10	.844	.828
12	1.016	.828
14	1.141	.828
16	1.265	.828
18	1.391	.828
20	1.500	.828
22	1.625	.828
24	1.750	.859

All dimensions for reference only

### CABLE CLAMP



\*10-476808-XXX

Cable Clamp Finish	Suffix
Bright Cadmium Plated Nickel Base	XX7
Anodic Coating (Alumilite)	XX5
Chromate Treated (Iridite 14-2)	XX0
Olive Drab Cadmium Plate Nickel Base	XX9
Electroless Nickel Coating	XXG

\* To complete order number, add shell size and suffix number. For example, shell size 10 with bright cadmium plated nickel base, 10-476808-107.

Cable Clamp Shell Size	A Dia. $^{+.010}_{-.025}$	B Dia. $^{+.000}_{-.011}$	L Max.	Y Thread Class 2B UNEF (Plated)	GG Max.
8	.125	.250	.922	.4375-28	.775
10	.188	.312	.922	.5625-24	.837
12	.312	.438	.922	.6875-24	.963
14	.375	.562	1.172	.8125-20	1.087
16	.500	.625	1.172	.9375-20	1.150
18	.625	.750	1.172	1.0625-18	1.400
20	.625	.750	1.172	1.1875-18	1.400
22	.750	.938	1.297	1.3125-18	1.587
24	.800	1.000	1.297	1.4375-18	1.681

All dimensions for reference only

F

# MIL-DTL-38999, Series III TV, II JT, I LJT

## Universal “Header Assembly” for Flex Print or PC Board

### MOUNTS TO ALL MIL-DTL-38999

The universal header assembly from Amphenol provides for easy separation of the connector from the board.

The header assembly is comprised of a short pin/socket contact. The tail end of the contact is soldered to the through hole of the flex or printed circuit board. The socket is embedded in the insulator, making electrical contact with the printed circuit tail of the connector.



**HEADERS PROVIDE EASY SEPARATION OF THE CONNECTOR FROM THE PC BOARD.**

### FEATURES AND BENEFITS:

- Circular and square header assemblies available
- Cost and time savings in the manufacturing process
- Assemblies can be vapor phase or wave soldered to flex/printed circuit board
- Allows electrical testing when installed properly.
- Connector assemblies can be easily removed from and reattached to the header assembly.

### MOUNTING APPLICATIONS

- Amphenol **square** universal headers are slotted to allow mounting to all series of MIL-DTL-38999 or MIL-DTL-26482 connectors without special alterations.
- Amphenol **circular** universal headers are designed to accommodate the rear flange of PCB Board Mount shells, series MIL-DTL-38999 connectors without special alterations.
- The header assembly can be attached to connectors with standard flange placement or directly to the circuit board.
- Connectors with dual flange mounting hardware can be provided to allow easy mounting to the panel or the header assembly.
  - Forward flange would mount the connector to the panel
  - Rear flange would be used to mount to the header assembly.
- Various types of captivated or loose attaching screws can be utilized for unique applications.

\* For information on Header Assemblies for MIL-DTL-26482 connector, consult Amphenol Aerospace.

### MOUNTING TO RECTANGULAR ARINC CONNECTORS

- Headers for ARINC connector arrangements accommodate up to 150 pins
- Consult Amphenol Canada, Ontario for ARINC configurations.

### MATERIALS

- Body is molded or machined from FR-4.
- Electrical engagement areas of the header contact are plated with .00003 inches minimum of gold over .00005 inches minimum of nickel.

See drawing of standard header on next page.

# MIL-DTL-38999, Series III TV, II JT, I LJT

## Universal "Header Assembly" for Flex Print or PC Board

38999

III

II

I

SJT

Access

Aquacon

Accessories

The drawing below shows the standard header assembly for use with MIL-DTL-38999 connectors.

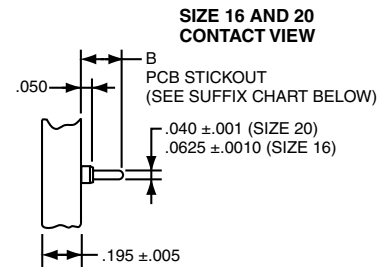
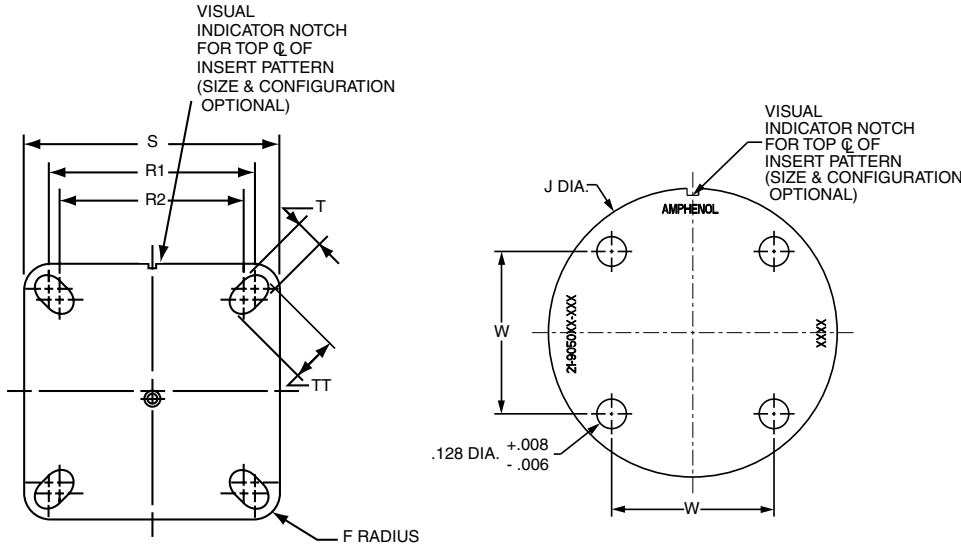

NOTE:  
 Size 16 accepts .048 to .064 dia. PCB tails.  
 Size 20 accepts .037 to .043 dia. PCB tails.  
 Size 22 & 23 accepts .018 to .022 dia. PCB tails.

Square Assembly Part Number	Shell Size	F Radius	S ± .005	T + .008 - .006	R1 TP†	R2 TP†	TT + .008 - .006
21-904008-XX()	8/9	.094	.938	.128	.719	.594	.216
21-904010-XX()	10/11	.094	1.031	.128	.812	.719	.194
21-904012-XX()	12/13	.094	1.125	.128	.906	.812	.194
21-904014-XX()	14/15	.125	1.219	.128	.969	.906	.173
21-904016-XX()	16/17	.125	1.312	.128	1.062	.969	.194
21-904018-XX()	18/19	.125	1.438	.128	1.156	1.062	.194
21-904020-XX()	20/21	.125	1.562	.128	1.250	1.156	.194
21-904022-XX()	22/23	.125	1.688	.154	1.375	1.250	.242
21-904024-XX()	24/25	.125	1.812	.154	1.500	1.375	.242

† TP designates true position dimensioning.

Circular Assembly Part Number	Shell Size	J Dia. ± .005	W
21-905008-XX()	8/9	1.016	.532
21-905010-XX()	10/11	1.062	.601
21-905012-XX()	12/13	1.250	.703
21-905014-XX()	14/15	1.375	.791
21-905016-XX()	16/17	1.500	.875
21-905018-XX()	18/19	1.625	.975
21-905020-XX()	20/21	1.750	1.053
21-905022-XX()	22/23	1.875	1.145
21-905024-XX()	24/25	2.000	1.233

### HOW TO ORDER INFORMATION FOR HEADER ASSEMBLY WITH MIL-DTL-38999 CONNECTORS

1. Series	2. Type	3. Shell Size & Insert Arrg.	4. PCB Suffix
21-	9040	08-03	1

1. SERIES		2. TYPE	
21-	Header Assembly	9040	Square
		9050	Circular

### 3. SELECT A SHELL SIZE & INSERT ARRANGEMENT SEE PAGES 2-5

Shell Size & Insert Arrangements are on pages 2-5. First number represents Shell Size, second number is the Insert Arrangement. The dash is required. See MIL-STD-1560 or 1669 document for coordinates of inserts.

\* Shell size designation for MIL-DTL-38999 Series I, II, III and IV and MIL-DTL-26482 Series 1 and 2.

4. CONTACT PCB STICKOUT		
Suffix	Shell Size*	Contact PCB Stickout Length
		B ± .015 Stickout
1	08	.120
1	09	.120
2	10	.185
3	12	.270
NA	14	
NA	15	
2	16	.185
3	16	.270
	18	
2	20	.185
3	20	.270
1	22	.120
2	22	.185
3	22	.270
1	23	.120
	24	
	25	

## Application Tools

The following data includes information pertaining to the application tools which have been established for crimping, inserting, and removing contacts incorporated in the TV, CTV and MIL-DTL-38999 Series III connectors. For additional information on coax, twinax and triax contact tools, see High Speed Contact section of this catalog.

All crimping tools included are the “full cycling” type and when used as specified in the installation instructions L-624 covering the TV, CTV and MS series connectors, will provide reliable crimped wire to contact terminations. There is a possibility of additional crimping tools other than those included being available at present or in the future for this specific application.

### CRIMPING TOOLS

Contact Size/Type	Crimping Tool	Turret Die or Positioner	Contact Size/Type	Crimping Tool	Turret Die or Positioner
12 Pin and Socket	M22520/1-01	M22520/1-04	8 Coaxial Inner Pin and Socket	M22520/2-01	M22520/2-31
16 Pin and Socket	M22520/1-01 M22520/7-01	M22520/1-04 M22520/7-04		M22520/5-01	M22520/5-05 Die Closure B
20 Pin and Socket	M22520/1-01 M22520/2-01 M22520/7-01	M22520/1-04 M22520/2-10 M22520/7-08	8 Coaxial Outer Pin and Socket	M22520/5-01	M22520/5-41 Die Closure B
22, 22D, 22M Pin	M22520/2-01 M22520/7-01	M22520/2-09 M22520/7-07		M22520/10-01	M22520/10-07 Die Closure B
22, 22D, 22M Socket Series I, III	M22520/2-01 M22520/7-01	M22520/2-07 M22520/7-05	16 Coaxial Inner Pin and Socket	M22520/2-01	M22520/2-35
22D Socket Series II	M22520/2-01 M22520/7-01	M22520/2-06 M22520/7-06	16 Coaxial Outer Pin and Socket	M22520/4-01	M22520/4-02
8 Twinax Center Pin and Socket	M22520/2-01	M22520/2-37	12 Coaxial Inner Pin and Socket	M22520/2-01	M22520/2-34
8 Twinax Intermediate Outer Pin & Socket	M22520/5-01	M22520/5-200	12 Coaxial Outer Pin and Socket	M22520/31-01	M22520/31-02
			10 (Power)	TP-201423	

Where 2 or 3 tools are listed for a contact size, only one tool and its die or positioner are required to crimp the contact. The above crimping tools and positioners are available from the approved tool manufacturer.

### INSERTION TOOLS

Use with Contact Size	Plastic Tools		Metal Tools			
	MS Part Number	Color	Angle Type		Straight Type Commercial Part No.	Color
			MS Part No.	Commercial Part No.		
10 (Power)	M81969/14-05*	Gray / (White)	M81969/8-11	†	†	Green
12	M81969/14-04*	Yellow / (White)	M81969/8-09	11-8674-12††	11-8794-12††	Yellow
16	M81969/14-03*	Blue / (White)	M81969/8-07	11-8674-16††	11-8794-16††	Blue
20	M81969/14-10*	Red / (Orange)	M81969/8-05	11-8674-20††	11-8794-20††	Red
22	M81969/14-09	Brown/White	M81969/8-03	11-8674-22††	11-8794-22††	Brown
22D, 22M	M81969/14-01*	Green / (White)	M81969/8-01	11-8674-24††	11-8794-24††	Black
8 Coaxial	None Required					
8 Twinax	None	None	None	None	None	Red

### REMOVAL TOOLS

Use with Contact Size	Plastic Tools		Metal Tools				
	MS Part Number	Color	For Unwired Contacts Commercial Part No.	Angle Type		Straight Type Commercial Part No.	Color
				MS Part No.	Commercial Part No.		
10 (Power)	M81969/14-05*	(Gray) / White	†	M81969/8-12	†	†	Green / White
12	M81969/14-04*	(Yellow) / White	11-10050-11††	M81969/8-10	11-8675-12††	11-8795-12††	Yellow / White
16	M81969/14-03*	(Blue) / White	11-10050-10††	M81969/8-08	11-8675-16††	11-8795-16††	Blue / White
20	M81969/14-10*	(Orange) / Red	11-10050-9††	M81969/8-06	11-8675-20††	11-8795-20††	Red / Orange
22	M81969/14-09*	(Brown)/White	11-10050-8††	M81969/8-04	11-8675-22††	11-8795-22††	Brown/White
22D, 22M	M81969/14-01*	(Green) / White	11-10050-7††	M81969/8-02	11-8675-24††	11-8795-24††	Green / White
8 Coaxial	M81969/14-12	Green	None	None	11-9170††	DRK264-8†††	N/A
8 Twinax	M81969/14-12	Green	None	None	11-9170††	N/A	N/A

For information about contacts see page 29. The M81969/8, 11-8674, 11-8675, and 11-8794 metal contact insertion and removal tools will accommodate wires having the maximum outside diameter as follows: Contact size 12: dia. is .155, size 16: dia. is .109, size 20: dia. is .077, size 22D: dia. is .050. When wire diameters exceed those specified, the plastic tools must be used.

\* Double end insertion/removal tool.

\*\* Twinax insertion tools are available only in a straight type, metal version.

† To be determined.

†† Contact Daniels Manufacturing Co. or Astro Tool Corp. for availability.

††† Daniels Manufacturing Co. part number

# 38999, Series I LJT, II JT, III TV, & SJT Assembly Instructions

38999

III

II

I

SJT

Access

Aquacon

Accessories

## WIRE STRIPPING

1. Strip wire to required length. (See Figure at right). When using hot wire stripping, do not wipe melted insulation material on wire strands; with mechanical strippers do not cut or nick strands.
  2. See Table 1 for proper finished outside wire dimensions.
  3. Twist strands together to form a firm bundle.
  4. Insert stripped wire into contact applying slight pressure until wire insulation butts against wire well. Check inspection hole to see that wire strands are visible. If there are strayed wire strands, entire wire end should be re-twisted.
- When wire is stripped and properly installed into contact, the next step is to crimp the wire inside the contact by using the proper crimping tool.

## STRIPPING DIMENSIONS



Wire Size	A
22, 22M, 22D	.125 (3.18)
20	.188 (4.77)
16	.188 (4.77)
12	.188 (4.77)

Table 1

Contact Size	Wire Dimension (inches)**	
	Min.	Max.
10	.135	.162
12	.097	.142
16	.065	.109
20	.040	.077
22	.034	.060
22M, 22D	.030	.050

\*\* Min. diameters to insure moisture proof assembly; max. diameters to permit use of metal removal tools.

## CRIMPING

See table on preceding page for recommended M22520 series crimping tools, turret head or positioner selection settings according to contact size, part number and wire gauge size.

1. Insert stripped wire into contact crimp pot. Wire must be visible through inspection hole.
2. Using correct crimp tool and locator, cycle the tool once to be sure the indentors are open, insert contact and wire into locator. Squeeze tool handles firmly and completely to insure a proper crimp. The tool will not release unless the crimp indentors in the tool head have been fully actuated.
3. Release crimped contact and wire from tool. Be certain the wire is visible through inspection hole in contact.



Examples of M22520 Series Crimping Tools:  
Shown top: tool used for small size 22, 22D and 22M contacts.

Shown bottom: tool used for size 20, 16 or 12 contacts and has a positioner that can be dialed for each contact size.

## CONTACT INSERTION

1. First remove hardware from the plug and receptacle and slide the hardware over wires in proper sequence.



2. Use proper plastic or metal insertion tool for corresponding contact. (Consult Insertion Tool table on preceding page). Slide correct tool (with plastic tool use colored end) over wire insulation and slide forward until tool bottoms against rear contact shoulder.



Plastic tool with contact in proper position.

3. Next align the tool and contact up to the properly identified cavity at rear of connector plug. Use firm, even pressure; do not use excessive pressure. It is recommended to start at the center cavity. Contact must be aligned with grommet hole and not inserted at an angle. Push forward until contact is felt to snap into position within insert.



Metal tool with contact.



Continued on next page.

Note: All plastic tools are double-ended. The colored side is the insertion tool and the white side is the removal tool.

# 38999, Series I LJT, II JT, III TV, & SJT Installation Instructions, cont.

## CONTACT INSERTION, CONT.

4. Remove tool and pull back lightly on wire, making sure contact stays properly seated and isn't dragged back with the tool. Repeat operation with remainder of contacts to be inserted, beginning with the center cavity and working outward in alternating rows.



5. After all contacts are inserted, fill any empty cavities with wire sealing plugs. (Refer to sealing plug charts for Series III on page 29, for Series I & II and SJT see page 30-31.)



6. Reassemble plug or receptacle hardware - slide forward and tighten using connector pliers. Connector holding tools are recommended while tightening back accessories. When using strain relief, center wires at bar clamp. Slide clamp grommet into position and tighten clamp bar screws. When tightening screws, pressure should be applied in the same direction that clamp is threaded to rear threads of connector. When not using clamp grommet, build up wire bundle with vinyl tape so clamp bar will maintain pressure on wires.



**CAUTION**, when inserting or removing contacts, do not spread or rotate tool tips.

## CONTACT REMOVAL

1. Remove hardware from plug or receptacle and slide hardware back along wire bundle.



2. Use proper plastic or metal removal tool for corresponding contact. (Consult Removal Tool table on page 167). Slide correct size tool over wire insulation.



Use white end of plastic tool for removal of contacts.

3. Insert plastic or metal removal tool into contact cavity until tool tips enter rear grommet and come to a positive stop. Hold tool tip firmly against positive stop on contact shoulder. Grip wire and simultaneously remove tool and contact. (On occasion, it may be necessary to remove tool, rotate 90° and reinsert.)



Removal of contacts with metal tool.

Компания «Океан Электроники» предлагает заключение долгосрочных отношений при поставках импортных электронных компонентов на взаимовыгодных условиях!

Наши преимущества:

- Поставка оригинальных импортных электронных компонентов напрямую с производств Америки, Европы и Азии, а так же с крупнейших складов мира;
- Широкая линейка поставок активных и пассивных импортных электронных компонентов (более 30 млн. наименований);
- Поставка сложных, дефицитных, либо снятых с производства позиций;
- Оперативные сроки поставки под заказ (от 5 рабочих дней);
- Экспресс доставка в любую точку России;
- Помощь Конструкторского Отдела и консультации квалифицированных инженеров;
- Техническая поддержка проекта, помощь в подборе аналогов, поставка прототипов;
- Поставка электронных компонентов под контролем ВП;
- Система менеджмента качества сертифицирована по Международному стандарту ISO 9001;
- При необходимости вся продукция военного и аэрокосмического назначения проходит испытания и сертификацию в лаборатории (по согласованию с заказчиком);
- Поставка специализированных компонентов военного и аэрокосмического уровня качества (Xilinx, Altera, Analog Devices, Intersil, Interpoint, Microsemi, Actel, Aeroflex, Peregrine, VPT, Syfer, Eurofarad, Texas Instruments, MS Kennedy, Miteq, Cobham, E2V, MA-COM, Hittite, Mini-Circuits, General Dynamics и др.);

Компания «Океан Электроники» является официальным дистрибьютором и эксклюзивным представителем в России одного из крупнейших производителей разъемов военного и аэрокосмического назначения «JONHON», а так же официальным дистрибьютором и эксклюзивным представителем в России производителя высокотехнологичных и надежных решений для передачи СВЧ сигналов «FORSTAR».



## JONHON

«JONHON» (основан в 1970 г.)

Разъемы специального, военного и аэрокосмического назначения:

(Применяются в военной, авиационной, аэрокосмической, морской, железнодорожной, горно- и нефтедобывающей отраслях промышленности)

«FORSTAR» (основан в 1998 г.)

ВЧ соединители, коаксиальные кабели, кабельные сборки и микроволновые компоненты:

(Применяются в телекоммуникациях гражданского и специального назначения, в средствах связи, РЛС, а так же военной, авиационной и аэрокосмической отраслях промышленности).



Телефон: 8 (812) 309-75-97 (многоканальный)

Факс: 8 (812) 320-03-32

Электронная почта: [ocean@oceanchips.ru](mailto:ocean@oceanchips.ru)

Web: <http://oceanchips.ru/>

Адрес: 198099, г. Санкт-Петербург, ул. Калинина, д. 2, корп. 4, лит. А