

EAO – Your Expert Partner for  
**Human Machine Interfaces**



## EAO Product Information

Series 04





<b>Description .....</b>	<b>3</b>
<b>Product Assembly .....</b>	<b>4</b>
<b>Mounting instruction .....</b>	<b>10</b>
<b>Devices raised mounting .....</b>	<b>12</b>
<b>Devices flush mounting .....</b>	<b>32</b>
<b>Accessories.....</b>	<b>48</b>
<b>Spare Parts .....</b>	<b>64</b>
<b>Technical Data.....</b>	<b>77</b>
<b>Typical Applications .....</b>	<b>84</b>
<b>Application guidelines.....</b>	<b>85</b>
<b>Marking .....</b>	<b>86</b>
<b>Drawings.....</b>	<b>91</b>
<b>Index.....</b>	<b>122</b>

## Product Information

### General notes

Series 04, a modular switching system, offers users a wide range of possible combinations. A broad variety of actuators is available, round or square in shape, for use as pushbuttons, keylock switches or lever-operated switches and indicators.

Other special actuators, such as mushroom heads or emergency-stop pushbuttons and buzzers can also be supplied.

Max. 3 switching elements, as snap-action or slow-make switches, can be clipped as modules to each actuator. Each switching element is equipped with 1 or 2 independent switching systems with normally closed or normally open contact.

Anodized aluminium parts can have visible variations due production-technical reasons.

### Mounting

The series 04 pushbuttons and switches in raised version are mounted in a 22.5 mm dia. cut-out or with appropriate adapter in 30.5 mm dia. mounting hole.

Flush mounted devices have a 30.5 mm dia. cutout or 30 x 30 mm.

### Terminals

The switching elements and the lamp blocks can be supplied with screw / plug-in terminals or push-in terminals.

### Lenses

Lenses of transparent plastic or aluminium are available in various standard colours.

### Marking

For further information about engraving, hot stamping and film inserts see part Marking.

### Illumination

The BA9s incandescent (filament) lamp (6, 12, 24, 36, 48, 60, 110, 130 V) ensures perfect illumination of the lenses, which are supplied in various colours.

BA9s Single-Chip LED (6, 12, 24, 28, 48 V) are also available in blue, green, red, white or yellow.

Luminosity and wave length scattering caused by the technology used in the LED manufacturing processes may lead to visual differences in our products.

### Position indication

The status of a maintained action switch can be determined by the position of the lens.

### Keylock switch

Standard lock number is 251, the last digit of Typ-Nr. = 0 (example : 704.335.0).

Additional lock numbers are available : 252 last digit = 1; 253 last digit = 2; 254 last digit = 3; 255 last digit = 4; 256 last digit = 5; 257 last digit = 6; 259 last digit = 8; 260 last digit = 9.

Two keys are supplied with each keylock switch.

### Keyinsert switch 704.095.0T28

EAO worked with the German Railways to develop an incredibly strong key-insert switch, which allows the conductor to close all the train's doors at the same time from any door using so called 'remote closing'. The switch, which has a 'massive' all-stainless steel construction, was modified from EAO's standard Series 04 switch to actuate the remote closing function with a single twist of the conductor's key; he can cancel or 'revoke' the remote closing with another twist of the key.

The important difference in the EAO design and the design of the switch they used previously is that it separates the function according to direction; accidental operation far less likely - twist one way for remote closing, twist the other way to cancel the remote closing.

The switch has a mechanical lifetime of 150 000 cycles and is incredibly durable to withstand the repeated use that might be necessary on every journey.

### Rotary selector switch

The rotary selector switch of series 04 are ideal control- and instrument switches. The switch types (CG4-1) are suitable particularly for switching of low tension. They correspond to the regulations after EN IEC 60947-3 and VDE 0660-Part 3.

By the special axial arrangement of the connecting terminals it is possible to mount the switches side by side or next to the cable duct. The contact marking remains well visible also in the mounted position. The required space of these switches is very small.

### Number structure

Nomenclature in accordance with ' CENELEC Certificate '. The certification document we dispatch to them on demands.

### Specimen order

#### Illuminated pushbutton:

- Illuminated pushbutton actuator, 30 x 30 mm 704.229.6  
Momentary action  
Front ring plastic black  
Lens plastic blue

#### Essential accessories:

- Single-Chip LED BA9s, 24 VAC/DC, blue 10-2512.1146
- Switching element, snap-action 704.900.5  
1 NC + 1 NO, hard silver  
screw terminal

*We reserve the right to modify technical data  
All dimensions in mm*

## Pushbutton, raised mounting



- 1 Front bezel
- 2 Lens
- 3 Marking foil
- 4 Lens holder
- 5 Actuator housing
- 6 Sealing
- 7 Front plate
- 8 Bayonet flange
- 9 Switching element

## Emergency-stop pushbutton



- 1 Emergency-stop pushbutton actuator
- 2 Sealing
- 3 Front plate
- 4 Bayonet flange
- 5 Switching element

## Keylock switch, raised mounting



- 1 Keylock switch actuator
- 2 Sealing
- 3 Front plate
- 4 Fixing nut
- 5 Switching element

## Rotary selector switch, raised mounting



- 1 Rotary selector switch actuator
- 2 Sealing
- 3 Front plate
- 4 Bayonet flange
- 5 Rotary switch element



## Indicator, flush mounting



- 1 Lens
- 2 Marking foil
- 3 Lens holder
- 4 LED
- 5 Actuator housing
- 6 Front plate
- 7 Pressure ring
- 8 Bayonet flange
- 9 Lamp element

## Pushbutton illuminated, flush mounting



- 1 Lens
- 2 Marking plate
- 3 LED
- 4 Actuator housing
- 5 Sealing
- 6 Front plate
- 7 Pressure ring
- 8 Bayonet flange
- 9 Lamp element
- 10 Switching element

## Selector switch, flush mounting



- 1 Selector switch actuator
- 2 Front plate
- 3 Pressure ring
- 4 Bayonet flange
- 5 Switching element

## Pushbutton

The actuator is inserted from the front through the mounting hole and locked at the rear by twisting the boyonet flange. The switch is fixed and positioned by evenly tightening the two screws in the mounting flange to a max. torque of 25 ... 30 Ncm. A reducing ring can be used to fit 22.5 mm into a 30.5 mm hole.



The switching elements (max. 3) or transformers, E-stop (max. 2), can easily be snapped in position without tools. LED's or filament lamps, as well as marking plates can be inserted or fitted from the front.



We can supply switching elements with terminal labels inserted.



To dismantle the switching elements or transformers one arm of the snap-on system is eased up with a screwdriver so that the snapped-on parts can easily be removed.



## Rotary selector switch

### Actuator

#### Step 1

Mounting of the actuator element:

1. Insert actuator from the front into the mounting hole.
2. Push mounting flange onto the actuator from the back and latch with bayonet.
3. Screw flange on with the two threaded pins.
4. Put lever into reference position (nine o'clock).



### Rotary switch element

#### Step 2

Snap rotary switch onto the actuator:

1. First check switch number with circuit diagram.
2. Put switching position of the cam at nine o'clock.
3. Snap rotary switch element onto the mounting flange, pay attention to position of the driver.
4. Check to see that the two snap-action legs have engaged.
5. Check the switching action in accordance with the switching sequence.



## Indicator full-face illumination compact



### Essential Accessories:

🛒 Single-LED page 58

	Front protection	Terminals		Ø 29 mm Typ-Nr.	Mounting dimensions	Technical drawing	Circuit drawing	
<b>Indicator full-face illumination compact</b> Filament lamp 130 V, max. 2.6 W with integrated series resistor 230/130 V Marking cap white translucent	IP 65	ST	Lens cap					
			Plastic blue translucent	<b>704.022.6</b>	3	2	51	0.025
			Plastic colourless translucent	<b>704.022.7</b>	3	2	51	0.025
			Plastic green translucent	<b>704.022.5</b>	3	2	51	0.025
			Plastic red translucent	<b>704.022.2</b>	3	2	51	0.025
Plastic yellow translucent	<b>704.022.4</b>	3	2	51	0.025			
Filament lamp 60 V, max. 2.6 W with integrated series resistor 125/60 V Marking cap white translucent	IP 65	ST	Plastic blue translucent	<b>704.024.6</b>	3	2	51	0.025
			Plastic colourless translucent	<b>704.024.7</b>	3	2	51	0.025
			Plastic green translucent	<b>704.024.5</b>	3	2	51	0.025
			Plastic red translucent	<b>704.024.2</b>	3	2	51	0.025
			Plastic yellow translucent	<b>704.024.4</b>	3	2	51	0.025
Filament lamp max. 2.6 W or LED Marking cap white translucent	IP 65	ST	Plastic blue translucent	<b>704.020.6</b>	3	2	5	0.020
			Plastic colourless translucent	<b>704.020.7</b>	3	2	5	0.020
			Plastic green translucent	<b>704.020.5</b>	3	2	5	0.020
			Plastic red translucent	<b>704.020.2</b>	3	2	5	0.020
			Plastic yellow translucent	<b>704.020.4</b>	3	2	5	0.020
Marking plate colourless transparent ribbed	IP 65	ST	Plastic blue transparent	<b>704.021.6</b>	3	2	5	0.020
			Plastic colourless transparent	<b>704.021.7</b>	3	2	5	0.020
			Plastic green transparent	<b>704.021.5</b>	3	2	5	0.020
			Plastic red transparent	<b>704.021.2</b>	3	2	5	0.020
			Plastic yellow transparent	<b>704.021.4</b>	3	2	5	0.020

Terminals: ST = Screw terminal

Mounting dimensions from page 91, Technical drawing from page 95, Circuit drawing from page 115

## Indicator full face illumination



### Essential Accessories:

 Single-LED page 58

	Front protection	Terminals	Frontbezel/-ring	Lens cap	∅ 30 x 30 mm Typ-Nr.	∅ 29 mm Typ-Nr.	Mounting dimensions	Technical drawing	Circuit drawing	
<b>Indicator full face illumination</b> Filament lamp or LED Marking plate white translucent	IP 65	ST	Plastic black	Plastic blue	<b>704.199.6</b>		5	3	5	0.050
				Plastic colourless	<b>704.199.7</b>		5	3	5	0.050
				Plastic green	<b>704.199.5</b>		5	3	5	0.050
				Plastic red	<b>704.199.2</b>		5	3	5	0.050
				Plastic yellow	<b>704.199.4</b>		5	3	5	0.050
			Plastic grey	Plastic blue	<b>704.200.6</b>		5	3	5	0.050
				Plastic colourless	<b>704.200.7</b>		5	3	5	0.050
				Plastic green	<b>704.200.5</b>		5	3	5	0.050
				Plastic red	<b>704.200.2</b>		5	3	5	0.050
			without	Plastic yellow	<b>704.200.4</b>		5	3	5	0.050
				Plastic blue		<b>704.000.6</b>	5	3	5	0.050
				Plastic colourless		<b>704.000.7</b>	5	3	5	0.050
				Plastic green		<b>704.000.5</b>	5	3	5	0.050
				Plastic red		<b>704.000.2</b>	5	3	5	0.050
			Marking cap colourless transparent ripped	IP 65	ST	without	Plastic blue		<b>704.001.6</b>	5
Plastic colourless		<b>704.001.7</b>					5	3	5	0.050
Plastic green		<b>704.001.5</b>					5	3	5	0.050
Plastic red		<b>704.001.2</b>					5	3	5	0.050
Plastic yellow		<b>704.001.4</b>					5	3	5	0.050

Terminals: ST = Screw terminal

Mounting dimensions from page 91, Technical drawing from page 95, Circuit drawing from page 115

## Indicator front illumination



### Essential Accessories:

🛒 Single-LED page 58

	Front protection	Terminals	Frontbezel/-ring	Lens	∅ 30 x 30 mm Typ-Nr.	∅ 29 mm Typ-Nr.	Mounting dimensions	Technical drawing	Circuit drawing	(mm)
<b>Indicator front illumination</b> Filament lamp or LED Marking plate white translucent	IP 65	ST	Plastic black	Plastic blue	<b>704.206.6</b>	<b>704.006.6</b>	5	5	5	0.050
				Plastic colourless	<b>704.206.7</b>	<b>704.006.7</b>	5	5	5	0.050
				Plastic green	<b>704.206.5</b>	<b>704.006.5</b>	5	5	5	0.050
				Plastic red	<b>704.206.2</b>	<b>704.006.2</b>	5	5	5	0.050
				Plastic yellow	<b>704.206.4</b>	<b>704.006.4</b>	5	5	5	0.050
			Plastic grey	Plastic blue	<b>704.202.6</b>	<b>704.002.6</b>	5	5	5	0.050
				Plastic colourless	<b>704.202.7</b>	<b>704.002.7</b>	5	5	5	0.050
				Plastic green	<b>704.202.5</b>	<b>704.002.5</b>	5	5	5	0.050
				Plastic red	<b>704.202.2</b>	<b>704.002.2</b>	5	5	5	0.050
				Plastic yellow	<b>704.202.4</b>	<b>704.002.4</b>	5	5	5	0.050
Marking plate colourless transparent ribbed	IP 65	ST	Plastic black	Plastic blue	<b>704.207.6</b>	<b>704.007.6</b>	5	5	5	0.050
				Plastic colourless	<b>704.207.7</b>	<b>704.007.7</b>	5	5	5	0.050
				Plastic green	<b>704.207.5</b>	<b>704.007.5</b>	5	5	5	0.050
				Plastic red	<b>704.207.2</b>	<b>704.007.2</b>	5	5	5	0.050
				Plastic yellow	<b>704.207.4</b>	<b>704.007.4</b>	5	5	5	0.050
			Plastic grey	Plastic blue	<b>704.203.6</b>	<b>704.003.6</b>	5	5	5	0.050
				Plastic colourless	<b>704.203.7</b>	<b>704.003.7</b>	5	5	5	0.050
				Plastic green	<b>704.203.5</b>	<b>704.003.5</b>	5	5	5	0.050
				Plastic red	<b>704.203.2</b>	<b>704.003.2</b>	5	5	5	0.050
				Plastic yellow	<b>704.203.4</b>	<b>704.003.4</b>	5	5	5	0.050

Terminals: ST = Screw terminal

Mounting dimensions from page 91, Technical drawing from page 95, Circuit drawing from page 115



## Flasher full face illumination



### Essential Accessories:

- Flasher element page 50
- Single-LED page 58

	Front protection	Frontbezel/-ring	Lens cap	Ø 30 x 30 mm Typ-Nr.	Ø 29 mm Typ-Nr.	Mounting dimensions	Technical drawing	Circuit drawing	kg
<b>Flasher full face illumination</b> Filament lamp or LED Marking plate white translucent	IP 65	Plastic black	Plastic blue	<b>704.199.6</b>		5	6	5	0.050
			Plastic colourless	<b>704.199.7</b>		5	6	5	0.050
			Plastic green	<b>704.199.5</b>		5	6	5	0.050
			Plastic red	<b>704.199.2</b>		5	6	5	0.050
			Plastic yellow	<b>704.199.4</b>		5	6	5	0.050
		Plastic grey	Plastic blue	<b>704.200.6</b>		5	6	5	0.050
			Plastic colourless	<b>704.200.7</b>		5	6	5	0.050
			Plastic green	<b>704.200.5</b>		5	6	5	0.050
			Plastic red	<b>704.200.2</b>		5	6	5	0.050
			Plastic yellow	<b>704.200.4</b>		5	6	5	0.050
		without	Plastic blue		<b>704.000.6</b>	5	6	5	0.050
			Plastic colourless		<b>704.000.7</b>	5	6	5	0.050
			Plastic green		<b>704.000.5</b>	5	6	5	0.050
			Plastic red		<b>704.000.2</b>	5	6	5	0.050
			Plastic yellow		<b>704.000.4</b>	5	6	5	0.050
Marking cap colourless transparent ripped	IP 65	without	Plastic blue		<b>704.001.6</b>	5	6	5	0.050
			Plastic colourless		<b>704.001.7</b>	5	6	5	0.050
			Plastic green		<b>704.001.5</b>	5	6	5	0.050
			Plastic red		<b>704.001.2</b>	5	6	5	0.050
			Plastic yellow		<b>704.001.4</b>	5	6	5	0.050

Mounting dimensions from page 91, Technical drawing from page 95, Circuit drawing from page 115

## Flasher front illumination



### Essential Accessories:

 Flasher element page 50

 Single-LED page 58

	Front protection	Frontbezel/-ring	Lens	∅ 30 x 30 mm Typ-Nr.	∅ 29 mm Typ-Nr.	Mounting dimensions	Technical drawing	Circuit drawing	
<b>Flasher front illumination</b> Filament lamp or LED Marking plate white translucent	IP 65	Plastic black	Plastic blue	<b>704.206.6</b>	<b>704.006.6</b>	5	7	5	0.050
			Plastic colourless	<b>704.206.7</b>	<b>704.006.7</b>	5	7	5	0.050
			Plastic green	<b>704.206.5</b>	<b>704.006.5</b>	5	7	5	0.050
			Plastic red	<b>704.206.2</b>	<b>704.006.2</b>	5	7	5	0.050
			Plastic yellow	<b>704.206.4</b>	<b>704.006.4</b>	5	7	5	0.050
		Plastic grey	Plastic blue	<b>704.202.6</b>	<b>704.002.6</b>	5	7	5	0.050
			Plastic colourless	<b>704.202.7</b>	<b>704.002.7</b>	5	7	5	0.050
			Plastic green	<b>704.202.5</b>	<b>704.002.5</b>	5	7	5	0.050
			Plastic red	<b>704.202.2</b>	<b>704.002.2</b>	5	7	5	0.050
			Plastic yellow	<b>704.202.4</b>	<b>704.002.4</b>	5	7	5	0.050
Marking plate colourless transparent ribbed	IP 65	Plastic black	Plastic blue	<b>704.207.6</b>	<b>704.007.6</b>	5	7	5	0.050
			Plastic colourless	<b>704.207.7</b>	<b>704.007.7</b>	5	7	5	0.050
			Plastic green	<b>704.207.5</b>	<b>704.007.5</b>	5	7	5	0.050
			Plastic red	<b>704.207.2</b>	<b>704.007.2</b>	5	7	5	0.050
			Plastic yellow	<b>704.207.4</b>	<b>704.007.4</b>	5	7	5	0.050
		Plastic grey	Plastic blue	<b>704.203.6</b>	<b>704.003.6</b>	5	7	5	0.050
			Plastic colourless	<b>704.203.7</b>	<b>704.003.7</b>	5	7	5	0.050
			Plastic green	<b>704.203.5</b>	<b>704.003.5</b>	5	7	5	0.050
			Plastic red	<b>704.203.2</b>	<b>704.003.2</b>	5	7	5	0.050
			Plastic yellow	<b>704.203.4</b>	<b>704.003.4</b>	5	7	5	0.050

Mounting dimensions from page 91, Technical drawing from page 95, Circuit drawing from page 115

## Buzzer



	Front protection	Front cap	Terminals	Ø 29 mm Typ-Nr.	Mounting dimensions	Technical drawing	Circuit drawing	
<b>Buzzer</b> Operation voltage 24 VDC	IP 65	Brass nickel-plated	S1	<b>14-810.902</b>	5	18	1	0.016
		Plastic black	S1	<b>14-810.002</b>	5	18	1	0.016

Further information in the Technical Data and Typical Applications

Terminals: S1 = Soldering terminal (also pluggable 2.8 x 0.5 mm)

Mounting dimensions from page 91, Technical drawing from page 95, Circuit drawing from page 115

## Pushbutton actuator



### Essential Accessories:

 Switching element page 51

	Front protection	Switching action	Frontbezel/-ring	Lens	□ 30 x 30 mm Typ-Nr.	∅ 29 mm Typ-Nr.	Mounting dimensions	Technical drawing	Circuit drawing		
Pushbutton actuator	IP 65	MA	Plastic black	Plastic black	<b>704.239.0</b>	<b>704.039.0</b>	5	4	3	0.040	
				Plastic blue	<b>704.239.6</b>	<b>704.039.6</b>	5	4	3	0.040	
				Plastic colourless	<b>704.239.7</b>	<b>704.039.7</b>	5	4	3	0.040	
				Plastic green	<b>704.239.5</b>	<b>704.039.5</b>	5	4	3	0.040	
				Plastic red	<b>704.239.2</b>	<b>704.039.2</b>	5	4	3	0.040	
				Plastic yellow	<b>704.239.4</b>	<b>704.039.4</b>	5	4	3	0.040	
			Plastic grey	Plastic black	<b>704.240.0</b>	<b>704.040.0</b>	5	4	3	0.040	
				Plastic blue	<b>704.240.6</b>	<b>704.040.6</b>	5	4	3	0.040	
				Plastic colourless	<b>704.240.7</b>	<b>704.040.7</b>	5	4	3	0.040	
				Plastic green	<b>704.240.5</b>	<b>704.040.5</b>	5	4	3	0.040	
				Plastic red	<b>704.240.2</b>	<b>704.040.2</b>	5	4	3	0.040	
				Plastic yellow	<b>704.240.4</b>	<b>704.040.4</b>	5	4	3	0.040	
			M	Plastic black	Plastic black	<b>704.209.0</b>	<b>704.009.0</b>	5	4	4	0.040
					Plastic blue	<b>704.209.6</b>	<b>704.009.6</b>	5	4	4	0.040
					Plastic colourless	<b>704.209.7</b>	<b>704.009.7</b>	5	4	4	0.040
					Plastic green	<b>704.209.5</b>	<b>704.009.5</b>	5	4	4	0.040
					Plastic red	<b>704.209.2</b>	<b>704.009.2</b>	5	4	4	0.040
					Plastic yellow	<b>704.209.4</b>	<b>704.009.4</b>	5	4	4	0.040
		Plastic grey		Plastic black	<b>704.210.0</b>	<b>704.010.0</b>	5	4	4	0.040	
				Plastic blue	<b>704.210.6</b>	<b>704.010.6</b>	5	4	4	0.040	
				Plastic colourless	<b>704.210.7</b>	<b>704.010.7</b>	5	4	4	0.040	
				Plastic green	<b>704.210.5</b>	<b>704.010.5</b>	5	4	4	0.040	
				Plastic red	<b>704.210.2</b>	<b>704.010.2</b>	5	4	4	0.040	
				Plastic yellow	<b>704.210.4</b>	<b>704.010.4</b>	5	4	4	0.040	
		MA	Aluminium natural	Aluminium black		<b>704.041.0</b>	5	4	3	0.040	
				Aluminium blue		<b>704.041.6</b>	5	4	3	0.040	
				Aluminium gold		<b>704.041.4</b>	5	4	3	0.040	
				Aluminium natural		<b>704.041.8</b>	5	4	3	0.040	
				Aluminium olive-green		<b>704.041.5</b>	5	4	3	0.040	
				Aluminium red		<b>704.041.2</b>	5	4	3	0.040	
				Plastic black		<b>704.042.0</b>	5	4	3	0.040	
				Plastic blue		<b>704.042.6</b>	5	4	3	0.040	
				Plastic colourless		<b>704.042.7</b>	5	4	3	0.040	
				Plastic green		<b>704.042.5</b>	5	4	3	0.040	
				Plastic red		<b>704.042.2</b>	5	4	3	0.040	
				Plastic yellow		<b>704.042.4</b>	5	4	3	0.040	

Continuation see next page

Continued from previous page

	Front protection	Switching action	Frontbezel/-ring	Lens	⌀ 30 x 30 mm Typ-Nr.	Ø 29 mm Typ-Nr.	Mounting dimensions	Technical drawing	Circuit drawing	IP			
<b>Pushbutton actuator</b>	IP 65	M	Aluminium natural	Aluminium black		<b>704.011.0</b>	5	4	4	0.040			
				Aluminium blue		<b>704.011.6</b>	5	4	4	0.040			
				Aluminium gold		<b>704.011.4</b>	5	4	4	0.040			
				Aluminium natural		<b>704.011.8</b>	5	4	4	0.040			
				Aluminium olive-green		<b>704.011.5</b>	5	4	4	0.040			
				Aluminium red		<b>704.011.2</b>	5	4	4	0.040			
				Plastic black		<b>704.012.0</b>	5	4	4	0.040			
				Plastic blue		<b>704.012.6</b>	5	4	4	0.040			
				Plastic colourless		<b>704.012.7</b>	5	4	4	0.040			
				Plastic green		<b>704.012.5</b>	5	4	4	0.040			
				Plastic red		<b>704.012.2</b>	5	4	4	0.040			
				Plastic yellow		<b>704.012.4</b>	5	4	4	0.040			
				IP 67	MA	Aluminium natural with protective cap	Plastic black		<b>704.043.0</b>	5	4	3	0.040
							Plastic blue		<b>704.043.6</b>	5	4	3	0.040
	Plastic colourless		<b>704.043.7</b>				5	4	3	0.040			
	Plastic green		<b>704.043.5</b>				5	4	3	0.040			
	Plastic red		<b>704.043.2</b>				5	4	3	0.040			
	Plastic yellow		<b>704.043.4</b>		5		4	3	0.040				
	M	Aluminium natural with protective cap	Plastic black				<b>704.013.0</b>	5	4	4	0.040		
			Plastic blue				<b>704.013.6</b>	5	4	4	0.040		
			Plastic colourless				<b>704.013.7</b>	5	4	4	0.040		
			Plastic green				<b>704.013.5</b>	5	4	4	0.040		
			Plastic red		<b>704.013.2</b>	5	4	4	0.040				
	Plastic yellow		<b>704.013.4</b>	5	4	4	0.040						

Fronting with protective cover to be mounted with a torque of 40 Ncm onto actuator.

Switching action: MA = Maintained action, M = Momentary action

Mounting dimensions from page 91, Technical drawing from page 95, Circuit drawing from page 115

## Illuminated pushbutton actuator



### Essential Accessories:

- Single-LED page 58
- Switching element page 51

	Front protection	Switching action	Frontbezel/-ring	Lens	∅ 30 x 30 mm Typ-Nr.	∅ 29 mm Typ-Nr.	Mounting dimensions	Technical drawing	Circuit drawing			
Illuminated pushbutton actuator	IP 65	MA	Plastic black	Plastic blue	<b>704.259.6</b>	<b>704.059.6</b>	5	8	34	0.056		
				Plastic colourless	<b>704.259.7</b>	<b>704.059.7</b>	5	8	34	0.056		
				Plastic green	<b>704.259.5</b>	<b>704.059.5</b>	5	8	34	0.056		
				Plastic red	<b>704.259.2</b>	<b>704.059.2</b>	5	8	34	0.056		
				Plastic yellow	<b>704.259.4</b>	<b>704.059.4</b>	5	8	34	0.056		
			Plastic grey	Plastic blue	<b>704.260.6</b>	<b>704.060.6</b>	5	8	34	0.056		
				Plastic colourless	<b>704.260.7</b>	<b>704.060.7</b>	5	8	34	0.056		
				Plastic green	<b>704.260.5</b>	<b>704.060.5</b>	5	8	34	0.056		
				Plastic red	<b>704.260.2</b>	<b>704.060.2</b>	5	8	34	0.056		
				Plastic yellow	<b>704.260.4</b>	<b>704.060.4</b>	5	8	34	0.056		
		M	Plastic black	Plastic blue	<b>704.229.6</b>	<b>704.029.6</b>	5	8	41	0.056		
				Plastic colourless	<b>704.229.7</b>	<b>704.029.7</b>	5	8	41	0.056		
				Plastic green	<b>704.229.5</b>	<b>704.029.5</b>	5	8	41	0.056		
				Plastic red	<b>704.229.2</b>	<b>704.029.2</b>	5	8	41	0.056		
				Plastic yellow	<b>704.229.4</b>	<b>704.029.4</b>	5	8	41	0.056		
			Plastic grey	Plastic blue	<b>704.230.6</b>	<b>704.030.6</b>	5	8	41	0.056		
				Plastic colourless	<b>704.230.7</b>	<b>704.030.7</b>	5	8	41	0.056		
				Plastic green	<b>704.230.5</b>	<b>704.030.5</b>	5	8	41	0.056		
				Plastic red	<b>704.230.2</b>	<b>704.030.2</b>	5	8	41	0.056		
				Plastic yellow	<b>704.230.4</b>	<b>704.030.4</b>	5	8	41	0.056		
	MA	Aluminium natural	Plastic blue		<b>704.062.6</b>	5	8	34	0.056			
			Plastic colourless		<b>704.062.7</b>	5	8	34	0.056			
			Plastic green		<b>704.062.5</b>	5	8	34	0.056			
			Plastic red		<b>704.062.2</b>	5	8	34	0.056			
			Plastic yellow		<b>704.062.4</b>	5	8	34	0.056			
	M	Aluminium natural	Plastic blue		<b>704.032.6</b>	5	8	41	0.056			
			Plastic colourless		<b>704.032.7</b>	5	8	41	0.056			
			Plastic green		<b>704.032.5</b>	5	8	41	0.056			
			Plastic red		<b>704.032.2</b>	5	8	41	0.056			
			Plastic yellow		<b>704.032.4</b>	5	8	41	0.056			
		Aluminium natural with protective cap	Plastic blue		<b>704.033.6</b>	5	8	41	0.056			
			Plastic colourless		<b>704.033.7</b>	5	8	41	0.056			
Plastic green				<b>704.033.5</b>	5	8	41	0.056				
Plastic red				<b>704.033.2</b>	5	8	41	0.056				
Plastic yellow				<b>704.033.4</b>	5	8	41	0.056				
IP 67			MA	Aluminium natural with protective cap	Plastic blue		<b>704.063.6</b>	5	8	34	0.056	
					Plastic colourless		<b>704.063.7</b>	5	8	34	0.056	
	Plastic green				<b>704.063.5</b>	5	8	34	0.056			
	Plastic red				<b>704.063.2</b>	5	8	34	0.056			
			Plastic yellow		<b>704.063.4</b>	5	8	34	0.056			

Continuation see next page

Continued from previous page

Frontring with protective cover to be mounted with a torque of 40 Ncm onto actuator.

Switching action: MA = Maintained action, M = Momentary action

Mounting dimensions from page 91, Technical drawing from page 95, Circuit drawing from page 115

## Emergency-stop pushbutton actuator, foolproof EN IEC 60947-5-5

Application as per DIN EN ISO 13850 and EN 60204-1



### Essential Accessories:

Switching element for Emergency-stop pushbutton page 54

	Front protection	Switching action	Mushroom had cap	Marking	Ø 37 mm Typ-Nr.	Mounting dimensions	Technical drawing	Circuit drawing	
<b>Emergency-stop pushbutton actuator, foolproof EN IEC 60947-5-5</b> Yellow actuator Key to unlock anti-clockwise Standard lock 9500 Max. 2 Slow-make elements can be clipped on	IP 65	MA	Plastic red	Arrows	<b>704.066.2</b>	2	24	6	0.300
Yellow actuator Twist to unlock anti-clockwise Max. 2 Slow-make elements can be clipped on	IP 65	MA	Plastic red	Arrows	<b>704.064.2</b>	2	14	6	0.300

Switching action: MA = Maintained action

Mounting dimensions from page 91, Technical drawing from page 95, Circuit drawing from page 115

## Stop pushbutton actuator



### Essential Accessories:

 Switching element for Emergency-stop pushbutton page 54

	Front protection	Switching action	Front ring	Mushroom had cap	Marking	Ø 40 mm Typ-Nr.	Mounting dimensions	Technical drawing	Circuit drawing	
<b>Stop pushbutton actuator</b> Key to unlock clockwise Standard lock 251	IP 65	MA	Aluminium natural	Plastic red	without	<b>704.078.0</b>	9	17	6	0.063
			Plastic grey	Plastic red	without	<b>704.076.0</b>	9	17	6	0.063
Twist to unlock clockwise	IP 65	MA	Aluminium natural	Plastic red	Arrows	<b>704.075.2</b>	9	12	6	0.047
					Stop	<b>704.075.3</b>	9	12	6	0.047
			Plastic grey	Plastic red	Arrows	<b>704.074.2</b>	9	12	6	0.047
					Stop	<b>704.074.3</b>	9	12	6	0.047

Switching action: MA = Maintained action

Mounting dimensions from page 91, Technical drawing from page 95, Circuit drawing from page 115



## Mushroom-head pushbutton actuator



### Essential Accessories:

 Switching element page 51

	Front protection	Switching action	Front ring	Mushroom had cap	Ø 40 mm Typ-Nr.	Mounting dimensions	Technical drawing	Circuit drawing	
<b>Mushroom-head pushbutton actuator</b>	IP 65	MA	Aluminium natural	Plastic black	<b>704.073.0</b>	9	15	3	0.044
				Plastic green	<b>704.073.5</b>	9	15	3	0.044
				Plastic red	<b>704.073.2</b>	9	15	3	0.044
				Plastic yellow	<b>704.073.4</b>	9	15	3	0.044
			Plastic grey	Plastic black	<b>704.072.0</b>	9	15	3	0.044
				Plastic green	<b>704.072.5</b>	9	15	3	0.044
				Plastic red	<b>704.072.2</b>	9	15	3	0.044
				Plastic yellow	<b>704.072.4</b>	9	15	3	0.044
		M	Aluminium natural	Plastic black	<b>704.071.0</b>	9	15	4	0.044
				Plastic green	<b>704.071.5</b>	9	15	4	0.044
				Plastic red	<b>704.071.2</b>	9	15	4	0.044
				Plastic yellow	<b>704.071.4</b>	9	15	4	0.044
			Plastic grey	Plastic black	<b>704.070.0</b>	9	15	4	0.044
				Plastic green	<b>704.070.5</b>	9	15	4	0.044
				Plastic red	<b>704.070.2</b>	9	15	4	0.044
				Plastic yellow	<b>704.070.4</b>	9	15	4	0.044

Switching action: MA = Maintained action, M = Momentary action

Mounting dimensions from page 91, Technical drawing from page 95, Circuit drawing from page 115

## Mushroom-head pushbutton actuator illuminated



### Essential Accessories:

-  Single-LED page 58
-  Switching element page 51

	Front protection	Switching action	Front ring	Mushroom had cap	Ø 40 mm Typ-Nr.	Mounting dimensions	Technical drawing	Circuit drawing	
<b>Mushroom-head pushbutton actuator illuminated</b>	IP 65	MA	Plastic grey	Plastic blue	<b>704.086.6</b>	9 13	34	0.044	
				Plastic colourless	<b>704.086.7</b>	9 13	34	0.044	
				Plastic green	<b>704.086.5</b>	9 13	34	0.044	
				Plastic red	<b>704.086.2</b>	9 13	34	0.044	
				Plastic yellow	<b>704.086.4</b>	9 13	34	0.044	
		M	Plastic grey	Plastic blue	<b>704.084.6</b>	9 13	41	0.044	
				Plastic colourless	<b>704.084.7</b>	9 13	41	0.044	
				Plastic green	<b>704.084.5</b>	9 13	41	0.044	
				Plastic red	<b>704.084.2</b>	9 13	41	0.044	
				Plastic yellow	<b>704.084.4</b>	9 13	41	0.044	

Switching action: MA = Maintained action, M = Momentary action

Mounting dimensions from page 91, Technical drawing from page 95, Circuit drawing from page 115

## Keylock switch actuator 2 positions



### Essential Accessories:

Switching element page 51

	Front protection	Switching action	Frontbezel/-ring	Key remove	□ 30 x 30 mm Typ-Nr.	Ø 29 mm Typ-Nr.	Mounting dimensions	Technical drawing	Circuit drawing	
Maintain 90° 	IP 65	M	Plastic grey	A	<b>704.343.0</b>		5 9	44	0.070	
Momentary 42° 				B	<b>704.340.0</b>		5 9	45	0.070	
				C	<b>704.341.0</b>		5 9	45	0.070	
				C + B	<b>704.342.0</b>		5 9	45	0.070	
Position A : Basic position Position B : Momentary action 42° Standard lock 251	IP 65	M	Aluminium chromium-plated	A		<b>704.123.0</b>	5 9	44	0.070	
Position C + B : Maintained action 90° Standard lock 251				B		<b>704.120.0</b>	5 9	45	0.070	
				C		<b>704.121.0</b>	5 9	45	0.070	
				C + B		<b>704.122.0</b>	5 9	45	0.070	

Switching action: M = Momentary action, MA = Maintained action

Mounting dimensions from page 91, Technical drawing from page 95, Circuit drawing from page 115

## Keylock switch actuator 3 positions



### Essential Accessories:

Switching element page 51



	Front protection	Frontbezel/-ring	Switching action	Key remove	∅ 30 x 30 mm Typ-Nr.	∅ 29 mm Typ-Nr.	Mounting dimensions	Technical drawing	Circuit drawing	
<b>Keylock switch actuator 3 positions</b> Position C : Maintained action 42° Position A : Basic position Position B : Momentary action 42° Standard lock 251	IP 65	Plastic grey	MA-0-M	C	<b>704.337.0</b>		5	9	46	0.070
				C + A	<b>704.344.0</b>		5	9	46	0.070
Position C : Momentary action 42° Position A : Basic position Position B : Maintained action 42° Standard lock 251	IP 65	Plastic grey	M-0-MA	A	<b>704.338.0</b>		5	9	43	0.070
Position C + B : Maintained action 42° Position A : Basic position Standard lock 251	IP 65	Plastic grey	MA-0-MA	A	<b>704.334.0</b>		5	9	47	0.070
				C + B	<b>704.336.0</b>		5	9	47	0.070
Position C + B : Maintained action 90° Position A : Basic position Standard lock 251	IP 65	Plastic grey	MA-0-MA	C + A + B	<b>704.333.0</b>		5	9	47	0.070
Position C + B : Momentary action 42° Position A : Basic position Standard lock 251	IP 65	Plastic grey	M-0-M	A	<b>704.335.0</b>		5	9	42	0.070
Position C : Maintained action 42° Position A : Basic position Position B : Momentary action 42° Standard lock 251	IP 65	Aluminium chromium-plated	MA-0-M	C		<b>704.117.0</b>	5	9	46	0.070
				C + A		<b>704.124.0</b>	5	9	46	0.070
Position C : Momentary action 42° Position A : Basic position Position B : Maintained action 42° Standard lock 251	IP 65	Aluminium chromium-plated	M-0-MA	A		<b>704.118.0</b>	5	9	43	0.070
Position C + B : Maintained action 42° Position A : Basic position Standard lock 251	IP 65	Aluminium chromium-plated	MA-0-MA	A		<b>704.114.0</b>	5	9	47	0.070
				C + B		<b>704.116.0</b>	5	9	47	0.070
Position C + B : Maintained action 90° Position A : Basic position Standard lock 251	IP 65	Aluminium chromium-plated	MA-0-MA	C + A + B		<b>704.113.0</b>	5	9	47	0.070
Position C + B : Momentary action 42° Position A : Basic position Standard lock 251	IP 65	Aluminium chromium-plated	M-0-M	A		<b>704.115.0</b>	5	9	42	0.070

Switching action: MA = Maintained action, M = Momentary action

Mounting dimensions from page 91, Technical drawing from page 95, Circuit drawing from page 115

## Selector switch actuator 2 positions, short lever



### Essential Accessories:

Switching element page 51



	Front protection	Switching action	Frontbezel/-ring	Lever	Ø 30 x 30 mm Typ-Nr.	Ø 29 mm Typ-Nr.	Mounting dimensions	Technical drawing	Circuit drawing	
<b>Selector switch actuator 2 positions, short lever</b> Position A : Basic position Position B : Momentary action 42°	IP 65	M	Plastic grey	Plastic black	<b>704.512.0</b>	<b>704.412.0</b>	5 11	37	0.034	
Position C + B : Maintained action 90°	IP 65	MA	Plastic grey	Plastic black	<b>704.510.0</b>	<b>704.410.0</b>	5 11	38	0.034	
Position A : Basic position Position B : Momentary action 42°	IP 65	M	Aluminium natural	Plastic black		<b>704.413.0</b>	5 11	37	0.037	
Position C + B : Maintained action 90°	IP 65	MA	Aluminium natural	Plastic black		<b>704.411.0</b>	5 11	38	0.037	

Switching action: M = Momentary action, MA = Maintained action

Mounting dimensions from page 91, Technical drawing from page 95, Circuit drawing from page 115

## Selector switch actuator 2 positions, short lever, 12 o'clock



### Essential Accessories:

Switching element page 51



	Front protection	Switching action	Frontbezel/-ring	Lever	Ø 30 x 30 mm Typ-Nr.	Ø 29 mm Typ-Nr.	Mounting dimensions	Technical drawing	Circuit drawing	
<b>Selector switch actuator 2 positions, short lever, 12 o'clock</b> Position C + B : Maintained action 90°	IP 65	MA	Plastic grey	Plastic black	<b>704.510.0.12</b>	<b>704.410.0.12</b>	5 11	38	0.034	
Aluminium black			Plastic black		<b>704.411.0B.12</b>	5 11	38	0.037		
Aluminium natural			Plastic black		<b>704.411.0.12</b>	5 11	38	0.037		

Switching action: MA = Maintained action

Mounting dimensions from page 91, Technical drawing from page 95, Circuit drawing from page 115

## Selector switch actuator 2 positions, long lever



### Essential Accessories:

Switching element page 51



	Front protection	Switching action	Frontbezel/-ring	Lever	∅ 30 x 30 mm Typ-Nr.	∅ 29 mm Typ-Nr.	Mounting dimensions	Technical drawing	Circuit drawing	
<b>Selector switch actuator 2 positions, long lever</b> Position A : Basic position Position B : Momentary action 42°	IP 65	M	Plastic grey	Plastic black	<b>704.302.0</b>	<b>704.102.0</b>	6 10	37	0.034	
Position C + B : Maintained action 90°	IP 65	MA	Plastic grey	Plastic black	<b>704.300.0</b>	<b>704.100.0</b>	6 10	38	0.034	
Position A : Basic position Position B : Momentary action 42°	IP 65	M	Aluminium natural	Plastic black		<b>704.103.0</b>	6 10	37	0.037	
Position C + B : Maintained action 90°	IP 65	MA	Aluminium natural	Plastic black		<b>704.101.0</b>	6 10	38	0.037	

Switching action: M = Momentary action, MA = Maintained action

Mounting dimensions from page 91, Technical drawing from page 95, Circuit drawing from page 115

## Selector switch actuator 2 positions, long lever, 12 o'clock



### Essential Accessories:

Switching element page 51



	Front protection	Switching action	Frontbezel/-ring	Lever	∅ 30 x 30 mm Typ-Nr.	∅ 29 mm Typ-Nr.	Mounting dimensions	Technical drawing	Circuit drawing	
<b>Selector switch actuator 2 positions, long lever, 12 o'clock</b> Position C + B : Maintained action 90°	IP 65	MA	Plastic grey	Plastic black	<b>704.300.0.12</b>	<b>704.100.0.12</b>	6 10	38	0.034	
Aluminium black			Plastic black		<b>704.101.0D.12</b>	6 10	38	0.037		
Aluminium natural			Plastic black		<b>704.101.0.12</b>	6 10	38	0.037		

Switching action: MA = Maintained action

Mounting dimensions from page 91, Technical drawing from page 95, Circuit drawing from page 115

## Selector switch actuator 3 positions, short lever



### Essential Accessories:

Switching element page 51

Maintain/Momentary

42°



	Front protection	Switching action	Frontbezel/-ring	Lever	∅ 30 x 30 mm Typ-Nr.	∅ 29 mm Typ-Nr.	Mounting dimensions	Technical drawing	Circuit drawing	kg
<b>Selector switch actuator 3 positions, short lever</b> Position C : Maintained action 42° Position A : Basic position Position B : Momentary action 42°	IP 65	MA-0-M	Plastic grey	Plastic black	<b>704.506.0</b>	<b>704.406.0</b>	5	11	39	0.034
Position C : Momentary action 42° Position A : Basic position Position B : Maintained action 42°	IP 65	M-0-MA	Plastic grey	Plastic black	<b>704.508.0</b>	<b>704.408.0</b>	5	11	36	0.034
Position C + B : Maintained action 42° Position A : Basic position	IP 65	MA-0-MA	Plastic grey	Plastic black	<b>704.502.0</b>	<b>704.402.0</b>	5	11	40	0.034
Position C + B : Momentary action 42° Position A : Basic position	IP 65	M-0-M	Plastic grey	Plastic black	<b>704.504.0</b>	<b>704.404.0</b>	5	11	35	0.034
Position C : Maintained action 42° Position A : Basic position Position B : Momentary action 42°	IP 65	MA-0-M	Aluminium natural	Plastic black		<b>704.407.0</b>	5	11	39	0.037
Position C : Momentary action 42° Position A : Basic position Position B : Maintained action 42°	IP 65	M-0-MA	Aluminium natural	Plastic black		<b>704.409.0</b>	5	11	36	0.037
Position C + B : Maintained action 42° Position A : Basic position	IP 65	MA-0-MA	Aluminium natural	Plastic black		<b>704.403.0</b>	5	11	40	0.037
Position C + B : Momentary action 42° Position A : Basic position	IP 65	M-0-M	Aluminium natural	Plastic black		<b>704.405.0</b>	5	11	35	0.037

Switching action: MA = Maintained action, M = Momentary action

Mounting dimensions from page 91, Technical drawing from page 95, Circuit drawing from page 115

## Selector switch actuator 3 positions, long lever



### Essential Accessories:

Switching element page 51

Maintain/Momentary  
42°



	Front protection	Switching action	Frontbezel/-ring	Lever	□ 30 x 30 mm Typ-Nr.	∅ 29 mm Typ-Nr.	Mounting dimensions	Technical drawing	Circuit drawing	
<b>Selector switch actuator 3 positions, long lever</b> Position C : Maintained action 42° Position A : Basic position Position B : Momentary action 42°	IP 65	MA-0-M	Plastic grey	Plastic black	<b>704.296.0</b>	<b>704.096.0</b>	6	10	39	0.034
Position C : Momentary action 42° Position A : Basic position Position B : Maintained action 42°	IP 65	M-0-MA	Plastic grey	Plastic black	<b>704.298.0</b>	<b>704.098.0</b>	6	10	36	0.034
Position C + B : Maintained action 42° Position A : Basic position	IP 65	MA-0-MA	Plastic grey	Plastic black	<b>704.292.0</b>	<b>704.092.0</b>	6	10	40	0.034
Position C + B : Momentary action 42° Position A : Basic position	IP 65	M-0-M	Plastic grey	Plastic black	<b>704.294.0</b>	<b>704.094.0</b>	6	10	35	0.034
Position C : Maintained action 42° Position A : Basic position Position B : Momentary action 42°	IP 65	MA-0-M	Aluminium natural	Plastic black		<b>704.097.0</b>	6	10	39	0.037
Position C : Momentary action 42° Position A : Basic position Position B : Maintained action 42°	IP 65	M-0-MA	Aluminium natural	Plastic black		<b>704.099.0</b>	6	10	36	0.037
Position C + B : Maintained action 42° Position A : Basic position	IP 65	MA-0-MA	Aluminium natural	Plastic black		<b>704.093.0</b>	6	10	40	0.037
Position C + B : Momentary action 42° Position A : Basic position	IP 65	M-0-M	Aluminium natural	Plastic black		<b>704.095.0</b>	6	10	35	0.037

Switching action: MA = Maintained action, M = Momentary action

Mounting dimensions from page 91, Technical drawing from page 95, Circuit drawing from page 115



## Rotary selector switch actuator, short lever



### Essential Accessories:

-  Rotary selector switching element 30° page 55
-  Rotary selector switching element 45° page 55
-  Rotary selector switching element 60° page 56

	Front protection	Frontbezel/-ring	Lever	∅ 30 x 30 mm Typ-Nr.	∅ 29 mm Typ-Nr.	Mounting dimensions	Technical drawing	
<b>Rotary selector switch actuator, short lever</b> Position 0 : nine o'clock	IP 65	Plastic grey	Plastic black	<b>704.510.1KN</b>		4	69	0.045
		Aluminium natural	Plastic black		<b>704.411.1KN</b>	4	69	0.045

Mounting dimensions from page 91, Technical drawing from page 95

## Rotary selector switch actuator, long lever



### Essential Accessories:

-  Rotary selector switching element 30° page 55
-  Rotary selector switching element 45° page 55
-  Rotary selector switching element 60° page 56

	Front protection	Frontbezel/-ring	Lever	∅ 30 x 30 mm Typ-Nr.	∅ 29 mm Typ-Nr.	Mounting dimensions	Technical drawing	
<b>Rotary selector switch actuator, long lever</b> Position 0 : nine o'clock	IP 65	Plastic grey	Plastic black	<b>704.300.1KN</b>		4	70	0.045
		Aluminium natural	Plastic black		<b>704.101.1KN</b>	4	70	0.045
Position 0 : twelve o'clock	IP 65	Aluminium natural	Plastic black		<b>704.101.0KN</b>	4	70	0.045

Mounting dimensions from page 91, Technical drawing from page 95

## Indicator, flush mounting



### Essential Accessories:

 Single-LED page 58

	Front protection	Terminals	Frontbezel/-ring	Lens	∅ 35 x 35 mm Typ-Nr.	∅ 35 mm Typ-Nr.	Mounting dimensions	Technical drawing	Circuit drawing	
<b>Indicator, flush mounting</b>	IP 65	ST	Plastic black	Plastic blue	<b>704.206.600</b>		12	20	5	0.061
				Plastic colourless	<b>704.206.700</b>		12	20	5	0.061
				Plastic green	<b>704.206.500</b>		12	20	5	0.061
				Plastic red	<b>704.206.200</b>		12	20	5	0.061
				Plastic yellow	<b>704.206.400</b>		12	20	5	0.061
			Plastic silver	Plastic blue	<b>704.202.608</b>		12	20	5	0.061
				Plastic colourless	<b>704.202.708</b>		12	20	5	0.061
				Plastic green	<b>704.202.508</b>		12	20	5	0.061
				Plastic red	<b>704.202.208</b>		12	20	5	0.061
				Plastic yellow	<b>704.202.408</b>		12	20	5	0.061
			Aluminium natural	Plastic blue		<b>704.006.618</b>	7	20	5	0.061
				Plastic colourless		<b>704.006.718</b>	7	20	5	0.061
				Plastic green		<b>704.006.518</b>	7	20	5	0.061
				Plastic red		<b>704.006.218</b>	7	20	5	0.061
				Plastic yellow		<b>704.006.418</b>	7	20	5	0.061

Terminals: ST = Screw terminal

Mounting dimensions from page 91, Technical drawing from page 95, Circuit drawing from page 115

## Flasher, flush mounting



### Essential Accessories:

- Flasher element page 50
- Single-LED page 58

	Front protection	Frontbezel/-ring	Lens	Ø 35 x 35 mm Typ-Nr.	Ø 35 mm Typ-Nr.	Mounting dimensions	Technical drawing	Circuit drawing		
<b>Flasher, flush mounting</b>	IP 65	Plastic black	Plastic blue	<b>704.206.600</b>		12	21	5	0.061	
			Plastic colourless	<b>704.206.700</b>		12	21	5	0.061	
			Plastic green	<b>704.206.500</b>		12	21	5	0.061	
			Plastic red	<b>704.206.200</b>		12	21	5	0.061	
			Plastic yellow	<b>704.206.400</b>		12	21	5	0.061	
		Plastic silver	Plastic blue	<b>704.202.608</b>		12	21	5	0.061	
			Plastic colourless	<b>704.202.708</b>		12	21	5	0.061	
			Plastic green	<b>704.202.508</b>		12	21	5	0.061	
			Plastic red	<b>704.202.208</b>		12	21	5	0.061	
			Plastic yellow	<b>704.202.408</b>		12	21	5	0.061	
		Aluminium natural	Plastic blue			<b>704.006.618</b>	7	21	5	0.061
			Plastic colourless			<b>704.006.718</b>	7	21	5	0.061
			Plastic green			<b>704.006.518</b>	7	21	5	0.061
			Plastic red			<b>704.006.218</b>	7	21	5	0.061
			Plastic yellow			<b>704.006.418</b>	7	21	5	0.061

Mounting dimensions from page 91, Technical drawing from page 95, Circuit drawing from page 115

## Buzzer, flush mounting



	Front protection	Front cap	Terminals	Ø 35 mm Typ-Nr.	Mounting dimensions	Technical drawing	Circuit drawing	
<b>Buzzer, flush mounting</b> Operation voltage : 24 VDC	IP 40	Aluminium black	S1	<b>14-810.910</b>	7	68	1	0.016
		Aluminium natural	S1	<b>14-810.918</b>	7	68	1	0.016

Further information in the Technical Data and Typical Applications

Terminals: S1 = Soldering terminal (also pluggable 2.8 x 0.5 mm)

Mounting dimensions from page 91, Technical drawing from page 95, Circuit drawing from page 115

## Pushbutton actuator, flush mounting

non-illuminative



### Essential Accessories:

Switching element page 51

	Front protection	Switching action	Frontbezel/-ring	Lens	∅ 35 x 35 mm Typ-Nr.	∅ 35 mm Typ-Nr.	Mounting dimensions	Technical drawing	Circuit drawing	(E-3)	
<b>Pushbutton actuator, flush mounting</b>	IP 65	MA	Plastic black	Plastic black	<b>704.239.000</b>		12	22	3	0.051	
				Plastic blue	<b>704.239.600</b>		12	22	3	0.051	
				Plastic colourless	<b>704.239.700</b>		12	22	3	0.051	
				Plastic green	<b>704.239.500</b>		12	22	3	0.051	
				Plastic red	<b>704.239.200</b>		12	22	3	0.051	
				Plastic yellow	<b>704.239.400</b>		12	22	3	0.051	
			Plastic silver	Plastic black	<b>704.240.008</b>		12	22	4	0.051	
				Plastic blue	<b>704.240.608</b>		12	22	3	0.051	
				Plastic colourless	<b>704.240.708</b>		12	22	3	0.051	
				Plastic green	<b>704.240.508</b>		12	22	3	0.051	
				Plastic red	<b>704.240.208</b>		12	22	3	0.051	
				Plastic yellow	<b>704.240.408</b>		12	22	3	0.051	
			M	Plastic black	Plastic black	<b>704.209.000</b>		12	22	4	0.051
					Plastic blue	<b>704.209.600</b>		12	22	4	0.051
					Plastic colourless	<b>704.209.700</b>		12	22	4	0.051
					Plastic green	<b>704.209.500</b>		12	22	4	0.051
					Plastic red	<b>704.209.200</b>		12	22	4	0.051
					Plastic yellow	<b>704.209.400</b>		12	22	4	0.051
		Plastic silver		Plastic black	<b>704.210.008</b>		12	22	4	0.051	
				Plastic blue	<b>704.210.608</b>		12	22	4	0.051	
				Plastic colourless	<b>704.210.708</b>		12	22	4	0.051	
				Plastic green	<b>704.210.508</b>		12	22	4	0.051	
				Plastic red	<b>704.210.208</b>		12	22	4	0.051	
				Plastic yellow	<b>704.210.408</b>		12	22	4	0.051	
		MA		Aluminium natural	Aluminium black		<b>704.041.018</b>	7	22	3	0.051
					Aluminium blue		<b>704.041.618</b>	7	22	3	0.051
					Aluminium gold		<b>704.041.418</b>	7	22	3	0.051
					Aluminium natural		<b>704.041.818</b>	7	22	3	0.051
					Aluminium olive-green		<b>704.041.518</b>	7	22	3	0.051
					Aluminium red		<b>704.041.218</b>	7	22	3	0.051
			Plastic black			<b>704.042.018</b>	7	22	3	0.051	
			Plastic blue			<b>704.042.618</b>	7	22	3	0.051	
			Plastic colourless			<b>704.042.718</b>	7	22	3	0.051	
			Plastic green			<b>704.042.518</b>	7	22	3	0.051	
			Plastic red			<b>704.042.218</b>	7	22	3	0.051	
			Plastic yellow			<b>704.042.418</b>	7	22	3	0.051	

Continuation see next page

Continued from previous page

	Front protection	Switching action	Frontbezel/-ring	Lens	⌀ 35 x 35 mm Typ-Nr.	Ø 35 mm Typ-Nr.	Mounting dimensions	Technical drawing	Circuit drawing	
<b>Pushbutton actuator, flush mounting</b>	IP 65	M	Aluminium natural	Aluminium black		<b>704.011.018</b>	7	22	4	0.051
				Aluminium blue		<b>704.011.618</b>	7	22	4	0.051
				Aluminium gold		<b>704.011.418</b>	7	22	4	0.051
				Aluminium natural		<b>704.011.818</b>	7	22	4	0.051
				Aluminium olive-green		<b>704.011.518</b>	7	22	4	0.051
				Aluminium red		<b>704.011.218</b>	7	22	4	0.051
				Plastic black		<b>704.012.018</b>	7	22	4	0.051
				Plastic blue		<b>704.012.618</b>	7	22	4	0.051
				Plastic colourless		<b>704.012.718</b>	7	22	4	0.051
				Plastic green		<b>704.012.518</b>	7	22	4	0.051
				Plastic red		<b>704.012.218</b>	7	22	4	0.051
				Plastic yellow		<b>704.012.418</b>	7	22	4	0.051

Switching action: MA = Maintained action, M = Momentary action

Mounting dimensions from page 91, Technical drawing from page 95, Circuit drawing from page 115

## Illuminated pushbutton actuator, flush mounting



### Essential Accessories:

- Single-LED page 58
- Switching element page 51

	Front protection	Switching action	Frontbezel/-ring	Lens	∅ 35 x 35 mm Typ-Nr.	∅ 35 mm Typ-Nr.	Mounting dimensions			Technical drawing	Circuit drawing		
<b>Illuminated pushbutton actuator, flush mounting</b>	IP 65	MA	Plastic black	Plastic blue	<b>704.259.600</b>		12	19	3	0.051			
				Plastic colourless	<b>704.259.700</b>		12	19	3	0.051			
				Plastic green	<b>704.259.500</b>		12	19	3	0.051			
				Plastic red	<b>704.259.200</b>		12	19	3	0.051			
				Plastic yellow	<b>704.259.400</b>		12	19	3	0.051			
			Plastic silver	Plastic blue	<b>704.260.608</b>		12	19	3	0.051			
				Plastic colourless	<b>704.260.708</b>		12	19	3	0.051			
				Plastic green	<b>704.260.508</b>		12	19	3	0.051			
				Plastic red	<b>704.260.208</b>		12	19	3	0.051			
				Plastic yellow	<b>704.260.408</b>		12	19	3	0.051			
			M	Plastic black	Plastic blue	<b>704.229.600</b>		12	19	4	0.051		
					Plastic colourless	<b>704.229.700</b>		12	19	4	0.051		
					Plastic green	<b>704.229.500</b>		12	19	4	0.051		
					Plastic red	<b>704.229.200</b>		12	19	4	0.051		
		Plastic yellow			<b>704.229.400</b>		12	19	4	0.051			
		Plastic silver		Plastic blue	<b>704.230.608</b>		12	19	4	0.051			
				Plastic colourless	<b>704.230.708</b>		12	19	4	0.051			
				Plastic green	<b>704.230.508</b>		12	19	4	0.051			
				Plastic red	<b>704.230.208</b>		12	19	4	0.051			
				Plastic yellow	<b>704.230.408</b>		12	19	4	0.051			
		MA		Aluminium natural	Plastic blue		<b>704.062.618</b>	7	19	34	0.067		
					Plastic colourless		<b>704.062.718</b>	7	19	34	0.067		
					Plastic green		<b>704.062.518</b>	7	19	34	0.067		
					Plastic red		<b>704.062.218</b>	7	19	34	0.067		
			Plastic yellow			<b>704.062.418</b>	7	19	34	0.067			
		M	Aluminium natural	Plastic blue		<b>704.032.618</b>	7	19	41	0.067			
				Plastic colourless		<b>704.032.718</b>	7	19	41	0.067			
				Plastic green		<b>704.032.518</b>	7	19	41	0.067			
Plastic red				<b>704.032.218</b>	7	19	41	0.067					
Plastic yellow				<b>704.032.418</b>	7	19	41	0.067					

Switching action: MA = Maintained action, M = Momentary action

Mounting dimensions from page 91, Technical drawing from page 95, Circuit drawing from page 115

## Stop pushbutton actuator, flush mounting



### Essential Accessories:

Switching element for Emergency-stop pushbutton page 54

	Front protection	Switching action	Front ring	Mushroom had cap	Marking	Ø 40 mm Typ-Nr.	Mounting dimensions	Technical drawing	Circuit drawing	
<b>Stop pushbutton actuator, flush mounting</b> Twist to unlock clockwise	IP 65	MA	Aluminium black	Plastic red	Arrows	<b>704.074.210</b>	10	26	6	0.048
					Stop	<b>704.075.310</b>	10	26	6	0.048
			Aluminium natural	Plastic red	Arrows	<b>704.075.218</b>	10	26	6	0.048
					Stop	<b>704.075.318</b>	10	26	6	0.048

Switching action: MA = Maintained action

Mounting dimensions from page 91, Technical drawing from page 95, Circuit drawing from page 115

## Mushroom-head pushbutton actuator, flush mounting



### Essential Accessories:

Switching element page 51

	Front protection	Front ring	Switching action	Mushroom had cap	Ø 40 mm Typ-Nr.	Mounting dimensions	Technical drawing	Circuit drawing	
<b>Mushroom-head pushbutton actuator, flush mounting</b>	IP 65	Aluminium black	MA	Plastic red	<b>704.073.210</b>	10	27	3	0.041
				Plastic red	<b>704.071.210</b>	10	27	4	0.041
			Plastic yellow	<b>704.071.410</b>	10	27	4	0.041	
		Aluminium natural	M	Plastic red	<b>704.071.218</b>	10	27	4	0.041
				Plastic yellow	<b>704.071.418</b>	10	27	4	0.041

Switching action: MA = Maintained action, M = Momentary action

Mounting dimensions from page 91, Technical drawing from page 95, Circuit drawing from page 115

## Keylock switch actuator 2 positions, flush mounting



### Essential Accessories:

Switching element page 51



	Front protection	Switching action	Frontbezel/-ring	Key remove	35 x 35 mm Typ-Nr.	Ø 35 mm Typ-Nr.	Mounting dimensions	Technical drawing	Circuit drawing	
<b>Keylock switch actuator 2 positions, flush mounting</b> Position A : Basic position Position B : Momentary action 42° Standard lock 251	IP 65	M	Plastic black	A	<b>704.343.000</b>		12	25	44	0.099
			Plastic silver	A	<b>704.343.008</b>		12	25	44	0.099
Position C + B : Maintained action 90° Standard lock 251	IP 65	MA	Plastic black	B	<b>704.340.000</b>		12	25	45	0.099
				C	<b>704.341.000</b>		12	25	45	0.099
				C + B	<b>704.342.000</b>		12	25	45	0.099
			Plastic silver	B	<b>704.340.008</b>		12	25	45	0.099
				C	<b>704.341.008</b>		12	25	45	0.099
				C + B	<b>704.342.008</b>		12	25	45	0.099
Position A : Basic position Position B : Momentary action 42° Standard lock 251	IP 65	M	Aluminium natural	A		<b>704.123.018</b>	7	25	44	0.099
				Position C + B : Maintained action 90° Standard lock 251	IP 65	MA	Aluminium natural	B		<b>704.120.018</b>
C		<b>704.121.018</b>	7	25				45	0.099	
C + B		<b>704.122.018</b>	7	25				45	0.099	

Switching action: M = Momentary action, MA = Maintained action

Mounting dimensions from page 91, Technical drawing from page 95, Circuit drawing from page 115



## Keylock switch actuator 3 positions, flush mounting



### Essential Accessories:

Switching element page 51



	Front protection	Switching action	Frontbezel/-ring	Key remove	⌀ 35 x 35 mm Typ-Nr.	Ø 35 mm Typ-Nr.	Mounting dimensions	Technical drawing	Circuit drawing	
<b>Keylock switch actuator 3 positions, flush mounting</b> Position C : Maintained action 42° Position A : Basic position Position B : Momentary action 42° Standard lock 251	IP 65	MA-0-M	Plastic black	C	<b>704.337.000</b>		12	25	46	0.099
				C + A	<b>704.344.000</b>		12	25	46	0.099
			Plastic silver	C	<b>704.337.008</b>		12	25	46	0.099
				C + A	<b>704.344.008</b>		12	25	46	0.099
Position C : Momentary action 42° Position A : Basic position Position B : Maintained action 42° Standard lock 251	IP 65	M-0-MA	Plastic black	A	<b>704.338.000</b>		12	25	43	0.099
			Plastic silver	A	<b>704.338.008</b>		12	25	43	0.099
Position C + B : Maintained action 42° Position A : Basic position Standard lock 251	IP 65	MA-0-MA	Plastic black	A	<b>704.334.000</b>		12	25	47	0.099
				C + B	<b>704.336.000</b>		12	25	47	0.099
			Plastic silver	A	<b>704.334.008</b>		12	25	47	0.099
				C + B	<b>704.336.008</b>		12	25	47	0.099
Position C + B : Maintained action 90° Position A : Basic position Standard lock 251	IP 65	MA-0-MA	Plastic black	C + A + B	<b>704.333.000</b>		12	25	47	0.099
			Plastic silver	C + A + B	<b>704.333.008</b>		12	25	47	0.099
Position C + B : Momentary action 42° Position A : Basic position Standard lock 251	IP 65	M-0-M	Plastic black	A	<b>704.335.000</b>		12	25	42	0.099
			Plastic silver	A	<b>704.335.008</b>		12	25	42	0.099
Position C : Maintained action 42° Position A : Basic position Position B : Momentary action 42° Standard lock 251	IP 65	MA-0-M	Aluminium natural	C		<b>704.117.018</b>	7	25	46	0.099
				C + A		<b>704.124.018</b>	7	25	46	0.099
Position C : Momentary action 42° Position A : Basic position Position B : Maintained action 42° Standard lock 251	IP 65	M-0-MA	Aluminium natural	A		<b>704.118.018</b>	7	25	43	0.099
Position C + B : Maintained action 42° Position A : Basic position Standard lock 251	IP 65	MA-0-MA	Aluminium natural	A		<b>704.114.018</b>	7	25	47	0.099
				C + B		<b>704.116.018</b>	7	25	47	0.099
Position C + B : Maintained action 90° Position A : Basic position Standard lock 251	IP 65	MA-0-MA	Aluminium natural	C + A + B		<b>704.113.018</b>	7	25	47	0.099
Position C + B : Momentary action 42° Position A : Basic position Standard lock 251	IP 65	M-0-M	Aluminium natural	A		<b>704.115.018</b>	7	25	42	0.099

Switching action: MA = Maintained action, M = Momentary action

Mounting dimensions from page 91, Technical drawing from page 95, Circuit drawing from page 115

## Selector switch actuator 2 positions, short lever, flush mounting



### Essential Accessories:

Switching element page 51



	Front protection	Switching action	Frontbezel/-ring	Lever	∅ 35 x 35 mm Typ-Nr.	∅ 35 mm Typ-Nr.	Mounting dimensions	Technical drawing	Circuit drawing	
<b>Selector switch actuator 2 positions, short lever, flush mounting</b> Position A : Basic position Position B : Momentary action 42°	IP 65	M	Plastic black	Plastic black	<b>704.512.000</b>		12	23	37	0.056
			Plastic silver	Plastic black	<b>704.512.008</b>		12	23	37	0.056
Position C + B : Maintained action 90°	IP 65	MA	Plastic black	Plastic black	<b>704.510.000</b>		12	23	38	0.056
			Plastic silver	Plastic black	<b>704.510.008</b>		12	23	38	0.056
Position A : Basic position Position B : Momentary action 42°	IP 65	M	Aluminium black	Plastic black		<b>704.413.010</b>	7	23	37	0.056
			Aluminium natural	Plastic black		<b>704.413.018</b>	7	23	37	0.056
Position C + B : Maintained action 90°	IP 65	MA	Aluminium black	Plastic black		<b>704.411.010</b>	7	23	38	0.056
			Aluminium natural	Plastic black		<b>704.411.018</b>	7	23	38	0.056

Switching action: M = Momentary action, MA = Maintained action

Mounting dimensions from page 91, Technical drawing from page 95, Circuit drawing from page 115

## Selector switch actuator 2 positions, short lever, 12 o'clock, flush mounting



### Essential Accessories:

Switching element page 51



	Front protection	Switching action	Frontbezel/-ring	Lever	∅ 35 x 35 mm Typ-Nr.	∅ 35 mm Typ-Nr.	Mounting dimensions	Technical drawing	Circuit drawing	
<b>Selector switch actuator 2 positions, short lever, 12 o'clock, flush mounting</b> Position C + B : Maintained action 90°	IP 65	MA	Plastic black	Plastic black	<b>704.510.000.12</b>		12	23	38	0.056
			Plastic silver	Plastic black	<b>704.510.008.12</b>		12	23	38	0.056
			Aluminium black	Plastic black		<b>704.411.010.12</b>	7	23	38	0.056
			Aluminium natural	Plastic black		<b>704.411.018.12</b>	7	23	38	0.056

Switching action: MA = Maintained action

Mounting dimensions from page 91, Technical drawing from page 95, Circuit drawing from page 115

## Selector switch actuator 2 positions, long lever, flush mounting



### Essential Accessories:

Switching element page 51

	Front protection	Switching action	Frontbezel/-ring	Lever	Ø 35 x 35 mm Typ-Nr.	Ø 35 mm Typ-Nr.	Mounting dimensions	Technical drawing	Circuit drawing	
<b>Selector switch actuator 2 positions, long lever, flush mounting</b> Position A : Basic position Position B : Momentary action 42°	IP 65	M	Plastic black	Plastic black	<b>704.302.000</b>		13	16	37	0.056
			Plastic silver	Plastic black	<b>704.302.008</b>		13	16	37	0.056
Position C + B : Maintained action 90°	IP 65	MA	Plastic black	Plastic black	<b>704.300.000</b>		13	16	38	0.056
			Plastic silver	Plastic black	<b>704.300.008</b>		13	16	38	0.056
Position A : Basic position Position B : Momentary action 42°	IP 65	M	Aluminium natural	Plastic black		<b>704.103.018</b>	7	16	37	0.056
			Plastic black	Plastic black		<b>704.101.018</b>	7	16	38	0.056
Position C + B : Maintained action 90°	IP 65	MA	Aluminium natural	Plastic black		<b>704.101.018</b>	7	16	38	0.056
			Plastic black	Plastic black		<b>704.101.010</b>	7	16	38	0.056

Switching action: M = Momentary action, MA = Maintained action

Mounting dimensions from page 91, Technical drawing from page 95, Circuit drawing from page 115

## Selector switch actuator 2 positions, long lever, 12 o'clock, flush mounting



### Essential Accessories:

Switching element page 51

	Front protection	Switching action	Frontbezel/-ring	Lever	Ø 35 x 35 mm Typ-Nr.	Ø 35 mm Typ-Nr.	Mounting dimensions	Technical drawing	Circuit drawing	
<b>Selector switch actuator 2 positions, long lever, 12 o'clock, flush mounting</b> Position C + B : Maintained action 90°	IP 65	MA	Plastic black	Plastic black	<b>704.300.000.12</b>		13	16	38	0.056
			Plastic silver	Plastic black	<b>704.300.008.12</b>		13	16	38	0.056
			Aluminium natural	Plastic black		<b>704.101.018.12</b>	7	16	38	0.056
			Plastic black	Plastic black		<b>704.101.010.12</b>	7	16	38	0.056

Switching action: MA = Maintained action

Mounting dimensions from page 91, Technical drawing from page 95, Circuit drawing from page 115

## Selector switch actuator 3 positions, short lever, flush mounting



### Essential Accessories:

Switching element page 51

Maintain/Momentary  
42°



	Front protection	Switching action	Frontbezel/-ring	Lever	Typ-Nr.	Ø 35 mm Typ-Nr.	Mounting dimensions			
							Technical drawing	Circuit drawing		
<b>Selector switch actuator 3 positions, short lever, flush mounting</b> Position C : Maintained action 42° Position A : Basic position Position B : Momentary action 42°	IP 65	MA-0-M	Plastic black	Plastic black	<b>704.506.000</b>		12	23	39	0.056
			Plastic silver	Plastic black	<b>704.506.008</b>		12	23	39	0.056
Position C : Momentary action 42° Position A : Basic position Position B : Maintained action 42°	IP 65	M-0-MA	Plastic black	Plastic black	<b>704.508.000</b>		12	23	36	0.056
			Plastic silver	Plastic black	<b>704.508.008</b>		12	23	36	0.056
Position C + B : Maintained action 42° Position A : Basic position	IP 65	MA-0-MA	Plastic black	Plastic black	<b>704.502.000</b>		12	23	40	0.056
			Plastic silver	Plastic black	<b>704.502.008</b>		12	23	40	0.056
Position C + B : Momentary action 42° Position A : Basic position	IP 65	M-0-M	Plastic black	Plastic black	<b>704.504.000</b>		12	23	35	0.056
			Plastic silver	Plastic black	<b>704.504.008</b>		12	23	35	0.056
Position C : Maintained action 42° Position A : Basic position Position B : Momentary action 42°	IP 65	MA-0-M	Aluminium black	Plastic black		<b>704.407.010</b>	7	23	39	0.056
			Aluminium natural	Plastic black		<b>704.407.018</b>	7	23	39	0.056
Position C : Momentary action 42° Position A : Basic position Position B : Maintained action 42°	IP 65	M-0-MA	Aluminium black	Plastic black		<b>704.409.010</b>	7	23	36	0.056
			Aluminium natural	Plastic black		<b>704.409.018</b>	7	23	36	0.056
Position C + B : Maintained action 42° Position A : Basic position	IP 65	MA-0-MA	Aluminium black	Plastic black		<b>704.403.010</b>	7	23	40	0.056
			Aluminium natural	Plastic black		<b>704.403.018</b>	7	23	40	0.056
Position C + B : Momentary action 42° Position A : Basic position	IP 65	M-0-M	Aluminium black	Plastic black		<b>704.405.010</b>	7	23	35	0.056
			Aluminium natural	Plastic black		<b>704.405.018</b>	7	23	35	0.056

Switching action: MA = Maintained action, M = Momentary action

Mounting dimensions from page 91, Technical drawing from page 95, Circuit drawing from page 115

## Selector switch actuator 3 positions, long lever, flush mounting



### Essential Accessories:

Switching element page 51

Maintain/Momentary  
42°



	Front protection	Switching action	Frontbezel/-ring	Lever	∅ 35 x 35 mm Typ-Nr.	∅ 35 mm Typ-Nr.	Mounting dimensions	Technical drawing	Circuit drawing	
<b>Selector switch actuator 3 positions, long lever, flush mounting</b> Position C : Maintained action 42° Position A : Basic position Position B : Momentary action 42°	IP 65	MA-0-M	Plastic black	Plastic black	<b>704.296.000</b>		13	23	39	0.056
			Plastic silver	Plastic black	<b>704.296.008</b>		13	23	39	0.056
Position C : Momentary action 42° Position A : Basic position Position B : Maintained action 42°	IP 65	M-0-MA	Plastic black	Plastic black	<b>704.298.000</b>		13	16	36	0.056
			Plastic silver	Plastic black	<b>704.298.008</b>		13	16	36	0.056
Position C + B : Maintained action 42° Position A : Basic position	IP 65	MA-0-MA	Plastic black	Plastic black	<b>704.292.000</b>		13	16	40	0.056
			Plastic silver	Plastic black	<b>704.292.008</b>		13	16	40	0.056
Position C + B : Momentary action 42° Position A : Basic position	IP 65	M-0-M	Plastic black	Plastic black	<b>704.294.000</b>		13	16	35	0.056
			Plastic silver	Plastic black	<b>704.294.008</b>		13	16	35	0.056
Position C : Maintained action 42° Position A : Basic position Position B : Momentary action 42°	IP 65	MA-0-M	Aluminium black	Plastic black		<b>704.097.010</b>	8	16	39	0.056
			Aluminium natural	Plastic black		<b>704.097.018</b>	8	16	39	0.056
Position C : Momentary action 42° Position A : Basic position Position B : Maintained action 42°	IP 65	M-0-MA	Aluminium black	Plastic black		<b>704.099.010</b>	8	16	36	0.056
			Aluminium natural	Plastic black		<b>704.099.018</b>	8	16	36	0.056
Position C + B : Maintained action 42° Position A : Basic position	IP 65	MA-0-MA	Aluminium black	Plastic black		<b>704.093.010</b>	8	16	40	0.056
			Aluminium natural	Plastic black		<b>704.093.018</b>	8	16	40	0.056
Position C + B : Momentary action 42° Position A : Basic position	IP 65	M-0-M	Aluminium black	Plastic black		<b>704.095.010</b>	8	16	35	0.056
			Aluminium natural	Plastic black		<b>704.095.018</b>	8	16	35	0.056

Switching action: MA = Maintained action, M = Momentary action

Mounting dimensions from page 91, Technical drawing from page 95, Circuit drawing from page 115

## Rotary selector switch actuator, short lever, flush mounting



### Essential Accessories:

-  Rotary selector switching element 30° page 55
-  Rotary selector switching element 45° page 55
-  Rotary selector switching element 60° page 56

	Front protection	Frontbezel/-ring	Lever	Ø 35 x 35 mm Typ-Nr.	Ø 35 mm Typ-Nr.	Mounting dimensions	Technical drawing	
<b>Rotary selector switch actuator, short lever, flush mounting</b> Position 0 : nine o'clock	IP 65	Plastic black	Plastic black	<b>704.510.100KN</b>		14	71	0.056
		Plastic silver	Plastic black	<b>704.510.108KN</b>		14	71	0.056
		Aluminium black	Plastic black		<b>704.411.110KN</b>	1	71	0.056
		Aluminium natural	Plastic black		<b>704.411.118KN</b>	1	71	0.056
Position 0 : twelve o'clock	IP 65	Aluminium black	Plastic black		<b>704.411.010KN</b>	1	71	0.056

Mounting dimensions from page 91, Technical drawing from page 95

## Rotary selector switch actuator, long lever, flush mounting



### Essential Accessories:

-  Rotary selector switching element 30° page 55
-  Rotary selector switching element 45° page 55
-  Rotary selector switching element 60° page 56

	Front protection	Frontbezel/-ring	Lever	Ø 35 x 35 mm Typ-Nr.	Ø 35 mm Typ-Nr.	Mounting dimensions	Technical drawing	
<b>Rotary selector switch actuator, long lever, flush mounting</b> Position 0 : nine o'clock	IP 65	Plastic black	Plastic black	<b>704.300.100KN</b>		14	72	0.056
		Plastic silver	Plastic black	<b>704.300.108KN</b>		14	72	0.056
		Aluminium black	Plastic black		<b>704.101.110KN</b>	1	72	0.056
		Aluminium natural	Plastic black		<b>704.101.118KN</b>	1	72	0.056
Position 0 : twelve o'clock	IP 65	Aluminium natural	Plastic black		<b>704.101.018KN</b>	1	72	0.056

Mounting dimensions from page 91, Technical drawing from page 95

## Keylock rotary switch actuator, flush mounting



### Essential Accessories:

-  Rotary selector switching element 30° page 55
-  Rotary selector switching element 45° page 55
-  Rotary selector switching element 60° page 56

	Front protection	Front ring	Key remove	Ø 35 mm Typ-Nr.	Mounting dimensions	Technical drawing	
<b>Keylock rotary switch actuator, flush mounting</b> Position 0 : nine o'clock (standard) Standard lock 251	IP 65	Aluminium natural	9 o'clock	<b>704.123.118KN</b>	7	73	0.120
Position 0 : twelve o'clock (special) Standard lock 251	IP 65	Aluminium natural	12 o'clock	<b>704.123.018KN</b>	7	73	0.120

Mounting dimensions from page 91, Technical drawing from page 95

## Key insert switch actuator 2 positions, flush mounting



### Essential Accessories:

-  Switching element page 51

	Front protection	Switching action	Front ring	Ø 38 mm Typ-Nr.	Mounting dimensions	Technical drawing	
<b>Key insert switch actuator 2 positions, flush mounting</b>	IP 67	0-MA90°	Stainless-steel	<b>704.101.0x28</b>	11	1	0.130
		0-M45°	Stainless-steel	<b>704.103.0x28</b>	11	1	0.130

In the Typ-Nr. "x" stands for not defined actuator.

Switching action: MA = Maintained action, M = Momentary action

Mounting dimensions from page 91, Technical drawing from page 95

## Key insert switch actuator 3 positions, flush mounting



### Essential Accessories:

 Switching element page 51

	Front protection	Front ring	Switching action	Ø 38 mm Typ-Nr.	Mounting dimensions	Technical drawing	
<b>Key insert switch actuator 3 positions, flush mounting</b>	IP 67	Stainless-steel	MA45°-0-MA45°	<b>704.093.0x28</b>	11	1	0.130
			MA45°-0-M45°	<b>704.097.0x28</b>	11	1	0.130
			M45°-0-MA45°	<b>704.099.0x28</b>	11	1	0.130
			M45°-0-M45°	<b>704.095.0x28</b>	11	1	0.130

In the Typ-Nr. "x" stands for not defined actuator.

Switching action: MA = Maintained action, M = Momentary action

Mounting dimensions from page 91, Technical drawing from page 95

## Key insert switch actuator 3 positions Conductor Switch, flush mounting



### Essential Accessories:

 Switching element page 51

	Front protection	Front ring	Switching action	Ø 38 mm Typ-Nr.	Mounting dimensions	Technical drawing	
<b>Key insert switch actuator 3 positions Conductor Switch, flush mounting</b>	IP 67	Stainless-steel	M45°-0-M45°	<b>704.095.0T28</b>	15	56	0.190

Switching action: M = Momentary action

Mounting dimensions from page 91, Technical drawing from page 95



## Lever switch



	Front protection	Front ring	Lever	Switching action	Contacts	Contact material	Ø 40 mm Typ-Nr.	
<b>Lever switch</b> Typ S41, Lever-Nr. 11, 1 Contact element	IP 54	Aluminium natural	Plastic black	MA / M	1 NC / 1 NO	Ag	<b>704.151.XXX</b>	0.230
Typ S42, Lever-Nr. 11, 1 Contact element	IP 54	Aluminium natural	Plastic black	MA / M	1 NC / 1 NO	Ag	<b>704.152.XXX</b>	0.230
Typ S43, Lever-Nr. 11, 1 Contact element	IP 54	Aluminium natural	Plastic black	MA / M	1 NC / 1 NO	Ag	<b>704.153.XXX</b>	0.230
Typ S44, Lever-Nr. 11, 1 Contact element positive opened	IP 54	Aluminium natural	Plastic black	MA / M	1 NC / 1 NO	Ag	<b>704.154.XXX</b>	0.230
Typ S45, Lever-Nr. 11, 1 Contact element positive open	IP 54	Aluminium natural	Plastic black	MA / M	1 NC / 1 NO	Ag	<b>704.155.XXX</b>	0.230

### Connection types

S41: Cage clamp 1.0 ... 1.5 mm<sup>2</sup>

S42: JST connector max. 0.2 mm<sup>2</sup> (counter plug is supplied)

S43: Plug-in terminal 6.3 x 0.8 mm

S44: Cage clamp 1.0 ... 1.5 mm<sup>2</sup>

S45: Screw terminal or plug-in terminal 6.3 x 0.8 mm.

### Micro-switch contacts

The micro-switch is available with a silver contact or a gold plated silver contact.

Contact without positive opening operation:

This is used in the lever switches S41, S42 and S43. Each lever switch includes a maximum of 5 micro-switches.

Contact with positive opening operation:

This is used in the lever switches S44 and S45. Each lever switch includes a maximum of 4 micro-switches.

### Levers

There are 8 alternative standard levers (02, 03, 04, 05, 11, 13, 14, 15) available. Special levers are available on request.

### Front bezel

Standard front bezel in aluminium natural, can also be delivered in black version.

### Note:

Typ-Nr. will be supplied once switching function has been defined including specification of lever style and switching positions.

For further information please contact your local sales office.

A detailed technical documentation is available separately.

Switching action: MA = Maintained action, M = Momentary action

Contacts: NC = Normally closed, NO = Normally open

Contact material: Ag = Silver

## Front

### Legend frame

adhesive, Aluminium black

	Typ-Nr.	Technical drawing	
<b>Legend frame</b> 30 x 50 mm for raised mounting	<b>704.968.2</b>	55	0.001
35 x 57.5 mm for flush mounting	<b>704.968.3</b>	60	0.001



Technical drawing from page 95

### Legend plate insert

for Legend frame 704.968.2 and 704.968.3

	Typ-Nr.	
<b>Legend plate insert</b> 14.5 x 23.5 mm, adhesive, Aluminium black	<b>704.968.1</b>	0.001
14.5 x 23.5 mm, adhesive, Aluminium natural	<b>704.968.0</b>	0.001



### Legend plate, square for flush mounting

	Typ-Nr.	
<b>Legend plate, square for flush mounting</b> 18 x 35 mm, adhesive, Aluminium black	<b>704.968.5</b>	0.001
18 x 35 mm, adhesive, Aluminium natural	<b>704.968.4</b>	0.001



### Protective cover

Mounting hole size 22.5 mm dia.

	Typ-Nr.	Technical drawing	
<b>Protective cover</b> hinged, transparent, with means for sealing, for Pushbutton	<b>704.925.0</b>	49	0.007
hinged, transparent, with means for sealing, for Selector switch	<b>704.925.2</b>	51	0.007
hinged, transparent, with means for sealing, with spring fitted, for Pushbutton	<b>704.925.3</b>	49	0.007



Protective cover only for selector switch in basic position A applicable.

Technical drawing from page 95

## Protective cover, flush mounting

Mounting hole size 30.5 mm dia.

	Typ-Nr.	Technical drawing	
<b>Protective cover, flush mounting</b> hinged, Aluminium natural, with means for sealing, for Pushbutton and Selector switch short lever	<b>704.928.38</b>	53	0.019
hinged, Aluminium natural, with means for sealing, spring fitted, for Pushbutton and Selector switch short lever	<b>704.928.28</b>	50	0.019
hinged, Aluminium natural, with window, spring fitted, for Pushbutton	<b>704.928.18</b>	52	0.019
hinged, transparent, with means for sealing, for Pushbutton	<b>704.925.7</b>	54	0.006

Technical drawing from page 95



## Blind plug

	Blind plug	Typ-Nr.	Technical drawing	
<b>Blind plug</b> Size 28 mm dia., for mounting hole 22.5 mm dia.	Plastic black	<b>704.960.4</b>	46	0.004
Size 30 x 30 mm, for mounting hole 22.5 mm dia.	Plastic black	<b>704.964.7</b>	43	0.009
Size 35 x 35 mm, for mounting hole 30 x 30 mm	Plastic black	<b>704.964.9</b>	45	0.009
Size 36 mm dia., for mounting hole 30.5 mm dia.	Plastic black	<b>704.964.8</b>	44	0.007

Technical drawing from page 95



## Spare key

	Typ-Nr.	
<b>Spare key</b> Standard lock 251	<b>704.989.251</b>	0.006

Other lock numbers on request



## Backside

### Flasher element



	Terminals	Typ-Nr.	Technical drawing		
			Circuit drawing		
<b>Flasher element</b> Operating voltage : 115 VAC $\pm 10\%$ , 50/60 Hz Lamp voltage/-current : 60 V, 33 mA	ST	<b>704.943.1</b>	32	12	0.024
Operating voltage : 130 VDC $\pm 10\%$ Lamp voltage/-current : 130 V, 3 mA	ST	<b>704.943.2</b>	32	12	0.024
Operating voltage : 230 VAC -10 % ... +6 %, 50/60 Hz Lamp voltage/-current : 130 V, 20 mA	ST	<b>704.943.0</b>	32	12	0.024
Operating voltage : 24 VDC $\pm 15\%$ Lamp voltage/-current : 24 V, 10 mA ... 85 mA	ST	<b>704.943.5</b>	32	12	0.024

Further information in the Technical Data and Typical Applications

Terminals: ST = Screw terminal

Technical drawing from page 95, Circuit drawing from page 115

## Switching element

	Switch rating	Switching system	Contacts	Contact material	Terminals	Typ-Nr.	Technical drawing	Circuit drawing			
<b>Switching element</b>	250 VAC, 6 A	SA	1 NC	Au-Ag	PIT	<b>704.907.2</b>	28	7	0.020		
				Ag-Cu	PIT	<b>704.908.2</b>	28	7	0.020		
			1 NC + 1 NO	Au-Ag	PIT	<b>704.907.5</b>	28	48	0.027		
				Ag-Cu	PIT	<b>704.908.5</b>	28	48	0.027		
			1 NO	Au-Ag	PIT	<b>704.907.1</b>	28	8	0.020		
				Ag-Cu	PIT	<b>704.908.1</b>	28	8	0.020		
			2 NC	Au-Ag	PIT	<b>704.907.4</b>	28	50	0.027		
				Ag-Cu	PIT	<b>704.908.4</b>	28	50	0.027		
			2 NO	Au-Ag	PIT	<b>704.907.3</b>	28	49	0.027		
				Ag-Cu	PIT	<b>704.908.3</b>	28	49	0.027		
			500 VAC, 10 A	SM	1 NC	Au-Ag	ST	<b>704.911.2</b>	29	7	0.021
						Ag-Cu	D-PT 6.3	<b>704.915.2/D</b>	31	7	0.025
	PT 6.3	<b>704.915.2</b>					30	7	0.021		
	ST	<b>704.910.2</b>					29	7	0.021		
	Ag-Pd	ST			<b>704.912.2</b>	29	7	0.021			
	1 NC + 1 NO	Au-Ag			ST	<b>704.911.5</b>	29	48	0.028		
		Ag-Cu			D-PT 6.3	<b>704.915.5/D</b>	31	48	0.032		
					PT 6.3	<b>704.915.5</b>	30	48	0.028		
					ST	<b>704.910.5</b>	29	48	0.028		
	Ag-Pd	ST			<b>704.912.5</b>	29	48	0.028			
	1 NO	Au-Ag			ST	<b>704.911.1</b>	29	8	0.021		
		Ag-Cu			D-PT 6.3	<b>704.915.1/D</b>	31	8	0.025		
					PT 6.3	<b>704.915.1</b>	30	8	0.021		
					ST	<b>704.910.1</b>	29	8	0.021		
	Ag-Pd	ST			<b>704.912.1</b>	29	8	0.021			
	2 NC	Au-Ag			ST	<b>704.911.4</b>	29	50	0.028		
		Ag-Cu			D-PT 6.3	<b>704.915.4/D</b>	31	50	0.032		
					PT 6.3	<b>704.915.4</b>	30	50	0.028		
					ST	<b>704.910.4</b>	29	50	0.028		
	Ag-Pd	ST			<b>704.912.4</b>	29	50	0.028			
	2 NO	Au-Ag			ST	<b>704.911.3</b>	29	49	0.028		
		Ag-Cu			D-PT 6.3	<b>704.915.3/D</b>	31	49	0.032		
PT 6.3					<b>704.915.3</b>	30	49	0.028			
ST					<b>704.910.3</b>	29	49	0.028			
Ag-Pd	ST	<b>704.912.3</b>	29	49	0.028						



Continuation see next page

Continued from previous page

	Switch rating	Switching system	Contacts	Contact material	Terminals	Typ-Nr.	Technical drawing	Circuit drawing	
<b>Switching element</b>	500 VAC, 10 A	SA	1 NC	Au-Ag	D-PT 6.3	<b>704.901.2/D</b>	31	7	0.026
					ST	<b>704.901.2</b>	29	7	0.021
				Ag-Cu	D-PT 6.3	<b>704.905.2/D</b>	31	7	0.026
					PT 6.3	<b>704.905.2</b>	30	7	0.021
				Ag-Pd	ST	<b>704.900.2</b>	29	7	0.021
					ST	<b>704.902.2</b>	29	7	0.021
			1 NC + 1 NO	Au-Ag	D-PT 6.3	<b>704.901.5/D</b>	31	48	0.033
					ST	<b>704.901.5</b>	29	48	0.028
				Ag-Cu	D-PT 6.3	<b>704.905.5/D</b>	31	48	0.033
					PT 6.3	<b>704.905.5</b>	30	48	0.028
				Ag-Pd	ST	<b>704.900.5</b>	29	48	0.028
					ST	<b>704.902.5</b>	29	48	0.028
			1 NO	Au-Ag	D-PT 6.3	<b>704.901.1/D</b>	31	8	0.026
					ST	<b>704.901.1</b>	29	8	0.021
				Ag-Cu	D-PT 6.3	<b>704.905.1/D</b>	31	8	0.026
					PT 6.3	<b>704.905.1</b>	30	8	0.021
				Ag-Pd	ST	<b>704.900.1</b>	29	8	0.021
					ST	<b>704.902.1</b>	29	8	0.021
			2 NC	Au-Ag	D-PT 6.3	<b>704.901.4/D</b>	31	50	0.033
					ST	<b>704.901.4</b>	29	50	0.028
				Ag-Cu	D-PT 6.3	<b>704.905.4/D</b>	31	50	0.033
					PT 6.3	<b>704.905.4</b>	30	50	0.028
				Ag-Pd	ST	<b>704.900.4</b>	29	50	0.028
					ST	<b>704.902.4</b>	29	50	0.028
			2 NO	Au-Ag	D-PT 6.3	<b>704.901.3/D</b>	31	49	0.033
					ST	<b>704.901.3</b>	29	49	0.028
				Ag-Cu	D-PT 6.3	<b>704.905.3/D</b>	31	49	0.033
					PT 6.3	<b>704.905.3</b>	30	49	0.028
				Ag-Pd	ST	<b>704.900.3</b>	29	49	0.028
					ST	<b>704.902.3</b>	29	49	0.028

For the 3rd switching element per switch the terminal marking insert is to be ordered separately.

Switching system: SA = Snap-action switching element, SM = Slow-make switching element

Contacts: NC = Normally closed, NO = Normally open

Contact material: Au-Ag = Gold-Silver, Ag-Cu = Hard silver, Ag-Pd = Silver-Palladium

Terminals: PIT = PIT Spring terminal, ST = Screw terminal, D-PT 6.3 = Double plug-in terminal 6.3 mm, PT 6.3 = Plug-in terminal 6.3 mm

Technical drawing from page 95, Circuit drawing from page 115

## Switching element for ring cable shoe



Switching element for ring cable shoe	Switching system	Contacts	Contact material	Terminals	Typ-Nr.	Technical drawing		Circuit drawing	
						Technical drawing	Circuit drawing		
Switching element for ring cable shoe	SM	1 NC	Au-Ag	ST	<b>704.911.2B</b>	29	7	0.021	
			Ag-Cu	ST	<b>704.910.2B</b>	29	7	0.021	
		1 NC + 1 NO	Au-Ag	ST	<b>704.911.5B</b>	29	48	0.028	
			Ag-Cu	ST	<b>704.910.5B</b>	29	48	0.028	
		1 NO	Au-Ag	ST	<b>704.911.1B</b>	29	8	0.021	
			Ag-Cu	ST	<b>704.910.1B</b>	29	8	0.021	
		2 NC	Au-Ag	ST	<b>704.911.4B</b>	29	50	0.028	
			Ag-Cu	ST	<b>704.910.4B</b>	29	50	0.028	
		2 NO	Au-Ag	ST	<b>704.911.3B</b>	29	49	0.028	
			Ag-Cu	ST	<b>704.910.3B</b>	29	49	0.028	
		SA	1 NC	Ag-Cu	ST	<b>704.900.2B</b>	29	7	0.021
			1 NC + 1 NO	Ag-Cu	ST	<b>704.900.5B</b>	29	48	0.028
	1 NO		Ag-Cu	ST	<b>704.900.1B</b>	29	8	0.021	
	2 NC		Ag-Cu	ST	<b>704.900.4B</b>	29	50	0.028	
2 NO	Ag-Cu		ST	<b>704.900.3B</b>	29	49	0.028		

Switching system: SM = Slow-make switching element, SA = Snap-action switching element

Contacts: NC = Normally closed, NO = Normally open

Contact material: Au-Ag = Gold-Silver, Ag-Cu = Hard silver

Terminals: ST = Screw terminal

Technical drawing from page 95, Circuit drawing from page 115

## Switching element for Emergency-stop pushbutton

	Switch rating	Switching system	Contacts	Contact material	Terminals	Typ-Nr.	Technical drawing		kg		
<b>Switching element for Emergency-stop pushbutton</b>	250 VAC, 6 A	SM	1 NC	Au-Ag	PIT	<b>704.917.2</b>	28	7	0.019		
				Ag-Cu	PIT	<b>704.918.2</b>	28	7	0.019		
			1 NC + 1 NO	Au-Ag	PIT	<b>704.917.5</b>	28	48	0.026		
				Ag-Cu	PIT	<b>704.918.5</b>	28	48	0.026		
			1 NO	Au-Ag	PIT	<b>704.917.1</b>	28	8	0.019		
				Ag-Cu	PIT	<b>704.918.1</b>	28	8	0.019		
			2 NC	Au-Ag	PIT	<b>704.917.4</b>	28	50	0.019		
				Ag-Cu	PIT	<b>704.918.4</b>	28	50	0.019		
			2 NO	Au-Ag	PIT	<b>704.917.3</b>	28	49	0.026		
				Ag-Cu	PIT	<b>704.918.3</b>	28	49	0.026		
			500 VAC, 10 A	SM	1 NC	Au-Ag	ST	<b>704.911.2</b>	29	7	0.021
						Ag-Cu	D-PT 6.3	<b>704.915.2/D</b>	31	7	0.025
	PT 6.3	<b>704.915.2</b>					30	7	0.021		
	ST	<b>704.910.2</b>					29	7	0.021		
	Ag-Pd	ST			<b>704.912.2</b>	29	7	0.021			
	1 NC + 1 NO	Au-Ag			ST	<b>704.911.5</b>	29	48	0.028		
		Ag-Cu			D-PT 6.3	<b>704.915.5/D</b>	31	48	0.032		
					PT 6.3	<b>704.915.5</b>	30	48	0.028		
					ST	<b>704.910.5</b>	29	48	0.028		
	Ag-Pd	ST			<b>704.912.5</b>	29	48	0.028			
	1 NO	Au-Ag			ST	<b>704.911.1</b>	29	8	0.021		
		Ag-Cu			D-PT 6.3	<b>704.915.1/D</b>	31	8	0.025		
					PT 6.3	<b>704.915.1</b>	30	8	0.021		
					ST	<b>704.910.1</b>	29	8	0.021		
Ag-Pd	ST	<b>704.912.1</b>			29	8	0.021				
2 NC	Au-Ag	ST			<b>704.911.4</b>	29	50	0.028			
	Ag-Cu	D-PT 6.3			<b>704.915.4/D</b>	31	50	0.032			
		PT 6.3			<b>704.915.4</b>	30	50	0.028			
		ST	<b>704.910.4</b>	29	50	0.028					
Ag-Pd	ST	<b>704.912.4</b>	29	50	0.028						
2 NO	Au-Ag	ST	<b>704.911.3</b>	29	49	0.028					
	Ag-Cu	D-PT 6.3	<b>704.915.3/D</b>	31	49	0.032					
		PT 6.3	<b>704.915.3</b>	30	49	0.028					
		ST	<b>704.910.3</b>	29	49	0.028					
Ag-Pd	ST	<b>704.912.3</b>	29	49	0.028						



Switching system: SM = Slow-make switching element

Contacts: NC = Normally closed, NO = Normally open

Contact material: Au-Ag = Gold-Silver, Ag-Cu = Hard silver, Ag-Pd = Silver-Palladium

Terminals: PIT = PIT Spring terminal, ST = Screw terminal, D-PT 6.3 = Double plug-in terminal 6.3 mm, PT 6.3 = Plug-in terminal 6.3 mm

Technical drawing from page 95, Circuit drawing from page 115



## Rotary selector switching element 30°

	Contacts	Stages	Terminals	Typ-Nr.	Circuit drawing	
<b>Rotary selector switching element 30°</b> Position a : Start position Position i : End position	9 (1-pole)	5	ST	<b>704.8A236</b>	13	0.073
Position a : Start position Position k : End position	10 (1-pole)	5	ST	<b>704.8A237</b>	14	0.073
Position a : Start position Position l : End position	11 (1-pole)	6	ST	<b>704.8A238</b>	15	0.082
Position a : Start position Position m : End position	12 (1-pole)	6	ST	<b>704.8A239</b>	16	0.082
Position a : Start position without stop	12 (1-pole)	6	ST	<b>704.8A639</b>	16	0.082



Rotary switching elements are not on stock and have to be ordered as a customised product locally

Terminals: ST = Screw terminal

Circuit drawing from page 115

## Rotary selector switching element 45°

	Contacts	Stages	Terminals	Typ-Nr.	Circuit drawing	
<b>Rotary selector switching element 45°</b> Position a : Start position Position g : End position	7 (1-pole)	4	ST	<b>704.8A234</b>	17	0.064
	7 (2-poles)	7	ST	<b>704.8A254</b>	18	0.091
Position a : Start position Position h : End position	8 (1-pole)	4	ST	<b>704.8A235</b>	19	0.064
	8 (2-poles)	8	ST	<b>704.8A255</b>	20	0.100



Rotary switching elements are not on stock and have to be ordered as a customised product locally

Terminals: ST = Screw terminal

Circuit drawing from page 115

## Rotary selector switching element 60°

	Contacts	Stages	Terminals	Typ-Nr.	Circuit drawing	
<b>Rotary selector switching element 60°</b> Position a : Start position Position c : End position	3 (1-pole)	2	ST	<b>704.8A230</b>	21	0.046
	3 (1-pole, DC-isolated)	2	ST	<b>704.8A730</b>	32	0.046
	3 (2-poles)	3	ST	<b>704.8A250</b>	22	0.055
	3 (3-poles)	5	ST	<b>704.8A270</b>	23	0.073
Position a : Start position Position d : End position	4 (1-pole)	2	ST	<b>704.8A231</b>	24	0.046
	4 (1-pole, DC isolated)	2	ST	<b>704.8A731</b>	33	0.046
	4 (2-poles)	4	ST	<b>704.8A251</b>	25	0.064
	4 (3-poles)	6	ST	<b>704.8A271</b>	26	0.082
Position a : Start position Position e : End position	5 (1-pole)	3	ST	<b>704.8A232</b>	27	0.055
	5 (2-poles)	5	ST	<b>704.8A252</b>	28	0.073
	5 (3-poles)	8	ST	<b>704.8A272</b>	29	0.100
Position a : Start position Position f : End position	6 (1-pole)	3	ST	<b>704.8A233</b>	30	0.055
	6 (2-poles)	6	ST	<b>704.8A253</b>	31	0.082



Rotary switching elements are not on stock and have to be ordered as a customised product locally

Terminals: ST = Screw terminal

Circuit drawing from page 115

## Terminal cover

	Typ-Nr.	Technical drawing	
<b>Terminal cover</b> for covering of screw terminal	<b>704.964.5</b>	35	0.003



Technical drawing from page 95

## Terminal marking

	Marking	Typ-Nr.	
<b>Terminal marking</b> 1 NC + 1 NO (for 1st or 2nd switching element)	13/21 33/41	<b>704.965.9</b>	0.001
	22/14 42/34	<b>704.966.0</b>	0.001
1 NC + 1 NO (for 3rd switching element)	53/61 73/81	<b>704.966.1</b>	0.001
	62/54 82/74	<b>704.966.2</b>	0.001
2 NC (for 1st or 2nd switching element)	11/21 31/41	<b>704.965.5</b>	0.001
	22/12 42/32	<b>704.965.6</b>	0.001
2 NC (for 3rd switching element)	51/61 71/81	<b>704.965.7</b>	0.001
	62/52 82/72	<b>704.965.8</b>	0.001
2 NO (for 1st or 2nd switching element)	13/23 33/43	<b>704.965.1</b>	0.001
	24/14 44/34	<b>704.965.2</b>	0.001
2 NO (for 3rd switching element)	53/63 73/83	<b>704.965.3</b>	0.001
	64/54 84/74	<b>704.965.4</b>	0.001



## Illumination

### Filament lamp

The max. overall length of the lamp may not exceed 25 mm

Filament lamp	Socket	Operating voltage/-current	Typ-Nr.	 kg
Filament lamp	BA9s	110 VAC/DC, 22 mA	<b>10-1422.1179</b>	0.002
		12 VAC/DC, 100 mA	<b>10-1409.1329</b>	0.002
		130 VAC/DC, 20 mA	<b>10-1424.1179</b>	0.002
		24 VAC/DC, 50 mA	<b>10-1412.1279</b>	0.002
		36 VAC/DC, 56 mA	<b>10-1416.1289</b>	0.002
		48 VAC/DC, 42 mA	<b>10-1419.1249</b>	0.002
		6 VAC/DC, 200 mA	<b>10-1406.1369</b>	0.002
		60 VAC/DC, 33 mA	<b>10-1420.1219</b>	0.002



## Single-LED

The max. overall length of the lamp may not exceed 25 mm

	Socket	Light colour	Operating voltage/-current	Typ-Nr.	
<b>Single-LED</b>	BA9s	blue	12 VAC/DC, 16 mA	<b>10-2509.1146</b>	0.002
			130 VAC, 5 mA	<b>10-2H24.2056</b>	0.002
			230 VAC, 3 mA	<b>10-2H25.2046</b>	0.002
			24 VAC/DC, 15 mA	<b>10-2512.1146</b>	0.002
			28 VAC/DC, 13 mA	<b>10-2513.1146</b>	0.002
			48 VAC/DC, 8 mA	<b>10-2519.1056</b>	0.002
		6 VDC, 17 mA	<b>10-2506.1086</b>	0.002	
		green	12 VAC/DC, 7 mA	<b>10-2509.1145</b>	0.002
			130 VAC, 3 mA	<b>10-2H24.2055</b>	0.002
			230 VAC, 2 mA	<b>10-2H25.2045</b>	0.002
			24 VAC/DC, 7 mA	<b>10-2512.1145</b>	0.002
			28 VAC/DC, 7 mA	<b>10-2513.1145</b>	0.002
			48 VAC/DC, 4 mA	<b>10-2519.1055</b>	0.002
		6 VDC, 7 mA	<b>10-2506.1085</b>	0.002	
		red	12 VAC/DC, 16 mA	<b>10-2509.1142</b>	0.002
			130 VAC, 5 mA	<b>10-2H24.2052</b>	0.002
			230 VAC, 3 mA	<b>10-2H25.2042</b>	0.002
			24 VAC/DC, 15 mA	<b>10-2512.1142</b>	0.002
			28 VAC/DC, 13 mA	<b>10-2513.1142</b>	0.002
			48 VAC/DC, 8 mA	<b>10-2519.1052</b>	0.002
		6 VDC, 17 mA	<b>10-2506.1082</b>	0.002	
		white diffuse	12 VAC/DC, 16 mA	<b>10-2509.1149</b>	0.002
			130 VAC, 5 mA	<b>10-2H24.2059</b>	0.002
			230 VAC, 3 mA	<b>10-2H25.2049</b>	0.002
			24 VAC/DC, 15 mA	<b>10-2512.1149</b>	0.002
			28 VAC/DC, 13 mA	<b>10-2513.1149</b>	0.002
			48 VAC/DC, 8 mA	<b>10-2519.1059</b>	0.002
		6 VDC, 17 mA	<b>10-2506.1089</b>	0.002	
		yellow	12 VAC/DC, 16 mA	<b>10-2509.1144</b>	0.002
			130 VAC, 5 mA	<b>10-2H24.2054</b>	0.002
			230 VAC, 3 mA	<b>10-2H25.2044</b>	0.002
			24 VAC/DC, 15 mA	<b>10-2512.1144</b>	0.002
			28 VAC/DC, 13 mA	<b>10-2513.1144</b>	0.002
			48 VAC/DC, 8 mA	<b>10-2519.1054</b>	0.002
		6 VDC, 17 mA	<b>10-2506.1084</b>	0.002	



Note:

AC operation through halve-wave rectifier possible, slight flickering can occur.

12, 24, 28, 48 VAC/DC versions with bridge rectifier. Used on a DC voltage and AC voltage with the same light output.

## Diode block

	Terminals	Typ-Nr.	Technical drawing	Circuit drawing	
<b>Diode block</b> 2 Diodes 1N4007	ST	<b>704.942.5</b>	34	2	0.019



Terminals: ST = Screw terminal

Technical drawing from page 95, Circuit drawing from page 115

## Lamp transformer

Lamp voltage/-current : 24 VAC, 50 mA, 50/60 Hz

	Terminals	Typ-Nr.	Technical drawing	Circuit drawing	
<b>Lamp transformer</b> Operating voltage : 115 VAC / 24 VAC	ST	<b>704.970.3</b>	33	9	0.100
Operating voltage : 230 VAC / 24 VAC	ST	<b>704.970.4</b>	33	9	0.100
Operating voltage : 400 VAC / 24 VAC	ST	<b>704.970.5</b>	33	9	0.100
Operating voltage : 440 VAC / 24 VAC	ST	<b>704.970.6</b>	33	9	0.100



Terminals: ST = Screw terminal

Technical drawing from page 95, Circuit drawing from page 115

## Resistor block

Lamp voltage/-current : 130 V, 20mA und 60 V, 33 mA

	Terminals	Typ-Nr.	Technical drawing	Circuit drawing	
<b>Resistor block</b> Operating voltage : 125 VAC / 60 VAC	ST	<b>704.941.5</b>	34	10	0.006
Operating voltage : 230 VAC / 130 VAC	ST	<b>704.941.0</b>	34	10	0.017



Terminals: ST = Screw terminal

Technical drawing from page 95, Circuit drawing from page 115

## Resistor-diode block

Lamp voltage/-current : 130 V, 20mA

	Terminals	Typ-Nr.	Technical drawing	Circuit drawing	
<b>Resistor-diode block</b> Operating voltage : 230 VAC / 130 VAC	ST	<b>704.941.9</b>	34	11	0.017



Terminals: ST = Screw terminal

Technical drawing from page 95, Circuit drawing from page 115

## Terminal plate empty

for fitting with series resistors

	Typ-Nr.	
<b>Terminal plate empty</b> 10 spaces 125 x 60 x 15 mm	<b>02-912.2</b>	0.045
15 spaces 187.5 x 60 x 15 mm	<b>02-912.3</b>	0.090
20 spaces 250 x 60 x 15 mm	<b>02-912.4</b>	0.095
5 spaces 62.5 x 60 x 15 mm	<b>02-912.1</b>	0.025



## Emergency-stop pushbutton

### Emergency-stop label

front panel thickness 3 mm max.

	Marking	Typ-Nr.	
<b>Emergency-stop label</b> 60 mm dia., yellow, Mounting hole size 22.5 mm dia.	ARRET D'URGENCE	<b>704.963.7</b>	0.011
	EMERGENCY STOP	<b>704.963.6</b>	0.011
	NOT AUS	<b>704.963.5</b>	0.011
	NOT HALT	<b>704.963.8</b>	0.011
90 mm dia., yellow, Mounting hole size 22.5 mm dia.	ARRET D'URGENCE	<b>704.963.2</b>	0.011
	EMERGENCY STOP	<b>704.963.1</b>	0.011
	NOT AUS	<b>704.963.0</b>	0.011
	NOT HALT	<b>704.963.3</b>	0.011



### Emergency-stop protective shroud

use only for Typ-Nr. 704.064.2 und 704.066.2

	Typ-Nr.	Technical drawing	
<b>Emergency-stop protective shroud</b> Plastic yellow, 50 mm dia., IP 65	<b>704.927.8</b>	58	0.024
Plastic yellow, 50 mm dia., IP 65, SEMI S2-93/12.4.c	<b>704.927.9</b>	59	0.052



The protection ring is not suitable for a proper use of Emergency-stop pushbutton. It can obstruct a spontaneous operation of the Emergency-stop pushbutton.

Technical drawing from page 95

### Emergency-stop enclosures

Bottom grey similar RAL 7035; cover lead-sealable, yellow similar RAL 1004

	Dimension	Typ-Nr.	Technical drawing	
<b>Emergency-stop enclosures</b> with mounting hole size 22.5 mm dia., with anti-twist device	L 65 mm, W 65 mm, H 81 mm	<b>704.945.7</b>	61	0.127
	L 94 mm, W 65 mm, H 81 mm	<b>704.945.8</b>	62	0.157
	L 94 mm, W 94 mm, H 81 mm	<b>704.945.0</b>	63	0.195



Openings for cable gland M16 or M20.

Protection class IP 66.

Technical drawing from page 95

## Cable gland

	Typ-Nr.	
<b>Cable gland</b> M16, Plastic grey	<b>61-9481.6</b>	0.007
M20, Plastic grey	<b>704.945.6</b>	0.011



with traction relief; protection degree IP 68.

## Assembling

### Anti-twist ring, flush mounting

	Typ-Nr.	
<b>Anti-twist ring, flush mounting</b>	<b>704.954.0</b>	0.002



### Reducing ring

Devices 22.5 mm dia. in mounting hole size 30.5 mm dia.

	Typ-Nr.	Technical drawing	
<b>Reducing ring</b> Aluminium black	<b>704.960.0</b>	57	0.004
Aluminium natural	<b>704.960.8</b>	57	0.004



With the metal bayonet flange you can use one reduction ring. If you have a plastic bayonet flange you need to install two reduction rings.

Technical drawing from page 95

### Mounting plate

for separate mounting of lamp transformer, resistor block or capacitor block

	Typ-Nr.	Technical drawing	
<b>Mounting plate</b>	<b>704.940.8</b>	36	0.006



Technical drawing from page 95

## Snap-on base

to snap-on, for separate mounting of lamp transformer, resistor block or capacitor block

	Typ-Nr.	Technical drawing	
<b>Snap-on base</b> DIN mounting bar EN 50022	<b>704.941.1</b>	38	0.006
DIN mounting bar EN 50035	<b>704.940.9</b>	37	0.006



Technical drawing from page 95

## Reinforcement plate

for thin front panel and plastic case

	Typ-Nr.	
<b>Reinforcement plate</b> 44 x 29 x 2 mm, mounting hole 22,5 mm dia., sheet steel galvanized yellow passivated	<b>704.960.9</b>	0.014



## Lens plug for round lens, flush mounting

with lamp remover function (BA9s)

	Typ-Nr.	
<b>Lens plug for round lens, flush mounting</b> for mounting and dismantling of Lens round, flush mounting	<b>700.006.0</b>	0.003



## Lens remover for square lens, flush mounting

	Typ-Nr.	
<b>Lens remover for square lens, flush mounting</b>	<b>98-968</b>	0.004



## Mounting tool for Indicator

for Indicators full-face illumination, compact

	Typ-Nr.	
<b>Mounting tool for Indicator</b> for tightening (or loosening) of the Fixing nut	<b>700.005.0</b>	0.020



## Mounting tool for Key insert switch

	Typ-Nr.	
<b>Mounting tool for Key insert switch</b> for tightening (or loosening) of the Fixing nut	<b>704.990.0</b>	0.020





## Enclosure

Grey similar RAL 7035; cover lead-sealable

	Dimension	Typ-Nr.	Technical drawing	
<b>Enclosure</b> with mounting hole 1 x 22.5 mm dia., with anti-twist device	L 94 mm, W 94 mm, H 81 mm	<b>704.945.1</b>	63	0.211
with mounting hole 2 x 22.5 mm dia., with anti-twist device	L 130 mm, W 94 mm, H 81 mm	<b>704.945.2</b>	64	0.251
with mounting hole 3 x 22.5 mm dia., with anti-twist device	L 180 mm, W 94 mm, H 81 mm	<b>704.945.3</b>	65	0.313
with mounting hole 4 x 22.5 mm dia., with anti-twist device	L 180 mm, W 182 mm, H 110 mm	<b>704.945.4</b>	66	0.572
with mounting hole 6 x 22.5 mm dia., with anti-twist device	L 180 mm, W 182 mm, H 110 mm	<b>704.945.5</b>	67	0.568



Openings for cable gland M16 or M20.

Protection class IP 66.

Technical drawing from page 95

## Cable gland

	Typ-Nr.	
<b>Cable gland</b> M16, Plastic grey	<b>61-9481.6</b>	0.007
M20, Plastic grey	<b>704.945.6</b>	0.011



with traction relief; protection degree IP 68.

## Indicator compact

## Indicator actuator for Indicator compact

	Housing	Ø 29 mm Typ-Nr.	Circuit drawing	
<b>Indicator actuator for Indicator compact</b> with series resistor for 110/125 V and incandescent lamp 60 V, 33 mA	Plastic grey	<b>704.642.1</b>	5	0.020
with series resistor for 220/240 V and incandescent lamp 130 V, 20 mA	Plastic grey	<b>704.642.2</b>	5	0.009
without built-in series resistor	Plastic grey	<b>704.642.0</b>	5	0.006



Circuit drawing from page 115

## Lens cap round, plastic

	Lens cap	Ø 29 mm Typ-Nr.	
<b>Lens cap round, plastic</b>	blue transparent	<b>704.603.6</b>	0.003
	colourless transparent	<b>704.603.7</b>	0.003
	green transparent	<b>704.603.5</b>	0.003
	red transparent	<b>704.603.2</b>	0.003
	yellow transparent	<b>704.603.4</b>	0.003



## Marking cap for Lens cap round

	Marking cap	Typ-Nr.	
<b>Marking cap for Lens cap round</b> LED	Plastic colourless transparent ribbed	<b>704.608.7</b>	0.002
LED and Filament lamp	Plastic white translucent	<b>704.608.9</b>	0.002



## Indicator and Flasher round, full face illumination

## Indicator actuator round, full face illumination

	Housing	Ø 29 mm Typ-Nr.	
<b>Indicator actuator round, full face illumination</b>	Plastic grey	<b>704.630.1</b>	0.020



## Lens cap round, plastic

	Lens cap	Ø 29 mm Typ-Nr.	
<b>Lens cap round, plastic</b>	blue transparent	<b>704.603.6</b>	0.003
	colourless transparent	<b>704.603.7</b>	0.003
	green transparent	<b>704.603.5</b>	0.003
	red transparent	<b>704.603.2</b>	0.003
	yellow transparent	<b>704.603.4</b>	0.003



## Marking cap for Lens cap round

	Marking cap	Typ-Nr.	
<b>Marking cap for Lens cap round</b>	LED	<b>704.608.7</b>	0.002
	LED and Filament lamp		
	Plastic colourless transparent ribbed	<b>704.608.7</b>	0.002
	Plastic white translucent	<b>704.608.9</b>	0.002



## Bayonet flange

	Typ-Nr.	Technical drawing	
<b>Bayonet flange</b>	<b>704.960.5</b>	48	0.025
Metal			
Plastic	<b>704.950.5</b>	47	0.015



Technical drawing from page 95

## Lamp block

	Terminals	Typ-Nr.	Technical drawing	Circuit drawing	
<b>Lamp block</b>	PIT	<b>704.950.3</b>	42	5	0.014
	Spring terminal				
Standard	PT 6.3	<b>704.950.1</b>	40	5	0.012
	ST	<b>704.950.0</b>	39	5	0.012
	Terminals Cu/Sn nickel plated	D-PT 6.3	<b>704.950.2/D</b>	41	5
Terminals Cu/Sn nickel plated and blank	D-PT 6.3	<b>704.950.1/D</b>	41	5	0.013
Terminals for ring cable shoe	ST	<b>704.950.0B</b>	39	5	0.013



Terminals: PIT = PIT Spring terminal, PT 6.3 = Plug-in terminal 6.3 mm, ST = Screw terminal, D-PT 6.3 = Double plug-in terminal 6.3 mm

Technical drawing from page 95, Circuit drawing from page 115

## Indicator and Flasher square, full face illumination

### Indicator actuator square, full face illumination

	Housing	∅ 30 x 30 mm Typ-Nr.	
Indicator actuator square, full face illumination	Plastic black	<b>704.730.0</b>	0.005
	Plastic grey	<b>704.730.1</b>	0.005



### Lens cap square, plastic

	Lens cap	∅ 30 x 30 mm Typ-Nr.	
Lens cap square, plastic	blue transparent	<b>704.703.6</b>	0.003
	colourless transparent	<b>704.703.7</b>	0.003
	green transparent	<b>704.703.5</b>	0.003
	red transparent	<b>704.703.2</b>	0.003
	yellow transparent	<b>704.703.4</b>	0.003



### Diffusor cap for Lens cap square

	Diffusor cap	∅ 30 x 30 mm Typ-Nr.	
Diffusor cap for Lens cap square can be marked	Plastic white	<b>704.708.9</b>	0.004
LED	Plastic colourless	<b>704.708.7</b>	0.004



### Marking foil for Lens square

	Marking foil	Typ-Nr.	
Marking foil for Lens square can be hot stamped	Plastic colourless transparent	<b>704.706.7</b>	0.001



### Bayonet flange

	Typ-Nr.	Technical drawing	
Bayonet flange Metal	<b>704.960.5</b>	48	0.025
Plastic	<b>704.950.5</b>	47	0.015



Technical drawing from page 95

## Lamp block

	Terminals	Typ-Nr.	Technical drawing	Circuit drawing	
<b>Lamp block</b> Spring terminal	PIT	<b>704.950.3</b>	42	5	0.014
Standard	PT 6.3	<b>704.950.1</b>	40	5	0.012
	ST	<b>704.950.0</b>	39	5	0.012
Terminals Cu/Sn nickel plated	D-PT 6.3	<b>704.950.2/D</b>	41	5	0.013
Terminals Cu/Sn nickel plated and blank	D-PT 6.3	<b>704.950.1/D</b>	41	5	0.013
Terminals for ring cable shoe	ST	<b>704.950.0B</b>	39	5	0.013

Terminals: PIT = PIT Spring terminal, PT 6.3 = Plug-in terminal 6.3 mm, ST = Screw terminal, D-PT 6.3 = Double plug-in terminal 6.3 mm

Technical drawing from page 95, Circuit drawing from page 115



## Indicator and Flasher round, front illumination

## Indicator actuator round, front illumination

	Housing	Typ-Nr.	
<b>Indicator actuator round, front illumination</b>	Plastic grey	<b>704.633.1</b>	0.020



## Lens round, flush, plastic

Lenses are usable for round devices in raised and flush mounting

	Lens	Symbol	Typ-Nr.	
<b>Lens round, flush, plastic</b>	black opaque	without	<b>704.602.0</b>	0.001
	blue transparent	without	<b>704.602.6</b>	0.001
	colourless transparent	Halo	<b>704.602.7A01</b>	0.001
		without	<b>704.602.7</b>	0.001
	green transparent	without	<b>704.602.5</b>	0.001
	red transparent	without	<b>704.602.2</b>	0.001
	yellow transparent	without	<b>704.602.4</b>	0.001



## Marking plate for Lens round, flush

	Marking plate	Typ-Nr.	
<b>Marking plate for Lens round, flush</b> Halo illumination	Plastic white translucent	<b>704.609.9A01</b>	0.001
LED	Plastic colourless transparent ribbed	<b>704.609.7</b>	0.001
LED and Filament lamp	Plastic white translucent	<b>704.609.9</b>	0.001
non-illuminative	Plastic black opaque	<b>704.609.0</b>	0.001



## Lens round raised, plastic

	Lens	Typ-Nr.	 kg
<b>Lens round raised, plastic</b>	colourless transparent	<b>704.611.7</b>	0.002
	green transparent	<b>704.611.5</b>	0.002
	red transparent	<b>704.611.2</b>	0.002
	yellow transparent	<b>704.611.4</b>	0.002



## Marking cap for Lens round, raised

	Marking cap	Typ-Nr.	 kg
<b>Marking cap for Lens round, raised LED</b>	Plastic colourless transparent ribbed	<b>704.610.7</b>	0.001
LED and Filament lamp	Plastic white translucent	<b>704.610.9</b>	0.001



## Front bezel set for Indicator and Pushbutton, flush mounting

	Front bezel	Ø 35 mm Typ-Nr.	Mounting dimensions	 kg
<b>Front bezel set for Indicator and Pushbutton, flush mounting</b>	Aluminium black	<b>704.955.0</b>	7	0.015
	Aluminium natural	<b>704.955.1</b>	7	0.015
	Stainless steel natural	<b>704.955.9</b>	7	0.033



Mounting dimensions from page 91

## Front bezel with protective membrane, flush mounting

for Pushbutton and Illuminated pushbutton (IP 67)

	Front bezel	Ø 35 mm Typ-Nr.	 kg
<b>Front bezel with protective membrane, flush mounting</b> with transparent silicone membrane	Aluminium black	<b>704.955.4</b>	0.015
	Aluminium natural	<b>704.955.3</b>	0.015
with transparent silicone membrane, resistant to sea water	Stainless steel natural	<b>704.955.9E</b>	0.033



Front bezel to be mounted with a torque of 40 Ncm onto actuator.

## Front ring

	Front ring	Ø 29 mm Typ-Nr.	
<b>Front ring</b>	Aluminium black	<b>704.600.1A</b>	0.005
	Aluminium natural	<b>704.600.1</b>	0.005
	Plastic black	<b>704.600.0</b>	0.003
	Plastic light-grey	<b>704.600.6</b>	0.003
	Stainless steel natural	<b>704.600.9</b>	0.006
Heigth 16 mm	Plastic light-grey	<b>704.600.7</b>	0.003



## Front protective cap

for Indicator, Pushbutton and Illuminated pushbutton for protection IP 68

	Front protective cap	Typ-Nr.	
<b>Front protective cap</b> only together with Lenses 704.602.X, 704.601.X and Front rings 704.600.X	Silicone colourless transparent	<b>704.953.0</b>	0.002



## Front protective ring

for Pushbutton and Illuminated pushbutton with front illumination (IP 67)

	Front protective ring	Ø 29 mm Typ-Nr.	
<b>Front protective ring</b> with transparent Pebax membrane, temperature resistance -40 °C ... +85 °C	Aluminium natural	<b>704.600.5/A</b>	0.005
	Aluminium natural	<b>704.600.3</b>	0.005
with transparent silicone membrane (extent resistant to sea water), temperature resistance -40 °C ... +85 °C	Chromed brass	<b>704.600.2</b>	0.005



Front protective ring to be mounted with a torque of 40 Ncm onto actuator.

## Bayonet flange

	Typ-Nr.	Technical drawing	
<b>Bayonet flange</b> Metal	<b>704.960.5</b>	48	0.025
Plastic	<b>704.950.5</b>	47	0.015



Technical drawing from page 95

## Lamp block

	Terminals	Typ-Nr.	Technical drawing	Circuit drawing	kg
<b>Lamp block</b>	PIT	<b>704.950.3</b>	42	5	0.014
Spring terminal					
Standard	PT 6.3	<b>704.950.1</b>	40	5	0.012
	ST	<b>704.950.0</b>	39	5	0.012
Terminals Cu/Sn nickel plated	D-PT 6.3	<b>704.950.2/D</b>	41	5	0.013
Terminals Cu/Sn nickel plated and blank	D-PT 6.3	<b>704.950.1/D</b>	41	5	0.013
Terminals for ring cable shoe	ST	<b>704.950.0B</b>	39	5	0.013

Terminals: PIT = PIT Spring terminal, PT 6.3 = Plug-in terminal 6.3 mm, ST = Screw terminal, D-PT 6.3 = Double plug-in terminal 6.3 mm

Technical drawing from page 95, Circuit drawing from page 115



## Indicator and Flasher square, front illumination

### Indicator actuator square, front illumination

	Front bezel	Housing	∅ 35 x 35 mm Typ-Nr.	∅ 30 x 30 mm Typ-Nr.	kg	
<b>Indicator actuator square, front illumination</b>	black	Plastic black	<b>704.743.0</b>		0.020	
	silver	Plastic black	<b>704.743.8</b>		0.020	
	without	Plastic black		<b>704.733.0</b>		0.020
		Plastic grey		<b>704.733.1</b>		0.020



### Lens square, plastic

	Lens	∅ 35 x 35 mm Typ-Nr.	∅ 30 x 30 mm Typ-Nr.	kg
<b>Lens square, plastic</b>	blue transparent	<b>704.702.6</b>	<b>704.702.6</b>	0.001
	colourless transparent	<b>704.702.7</b>	<b>704.702.7</b>	0.001
	green transparent	<b>704.702.5</b>	<b>704.702.5</b>	0.001
	red transparent	<b>704.702.2</b>	<b>704.702.2</b>	0.001
	yellow transparent	<b>704.702.4</b>	<b>704.702.4</b>	0.001



### Lens holder for Lens square

	Lens holder	Typ-Nr.	kg
<b>Lens holder for Lens square</b> can be marked	translucent white	<b>704.709.9</b>	0.003
LED	transparent colourless	<b>704.709.7</b>	0.003





## Marking foil for Lens square

	Marking foil	Typ-Nr.	
<b>Marking foil for Lens square</b> can be hot stamped	Plastic colourless transparent	<b>704.707.7</b>	0.001



## Front bezel square

	Front bezel	∅ 30 x 30 mm Typ-Nr.	
<b>Front bezel square</b>	Plastic black	<b>704.701.0</b>	0.002
	Plastic chromium-plated	<b>704.701.4</b>	0.002
	Plastic grey	<b>704.701.6</b>	0.002



## Bayonet flange

	Typ-Nr.	Technical drawing	
<b>Bayonet flange</b> Metal	<b>704.960.5</b>	48	0.025
Plastic	<b>704.950.5</b>	47	0.015



Technical drawing from page 95

## Lamp block

	Terminals	Typ-Nr.	Technical drawing	Circuit drawing	
<b>Lamp block</b> Spring terminal	PIT	<b>704.950.3</b>	42	5	0.014
Standard	PT 6.3	<b>704.950.1</b>	40	5	0.012
	ST	<b>704.950.0</b>	39	5	0.012
Terminals Cu/Sn nickel plated	D-PT 6.3	<b>704.950.2/D</b>	41	5	0.013
Terminals Cu/Sn nickel plated and blank	D-PT 6.3	<b>704.950.1/D</b>	41	5	0.013
Terminals for ring cable shoe	ST	<b>704.950.0B</b>	39	5	0.013

Terminals: PIT = PIT Spring terminal, PT 6.3 = Plug-in terminal 6.3 mm, ST = Screw terminal, D-PT 6.3 = Double plug-in terminal 6.3 mm

Technical drawing from page 95, Circuit drawing from page 115



### Pushbutton and Illuminated pushbutton round

#### Pushbutton- and Illuminated pushbutton actuator round

Actuators usable for devices with front dimension 29 mm dia., raised mounting and 35 mm dia., flush mounting

	Switching action	Housing	Typ-Nr.	
Pushbutton- and Illuminated pushbutton actuator round	MA	Plastic grey	<b>704.632.1</b>	0.009
	M	Plastic grey	<b>704.631.1</b>	0.009



Switching action: MA = Maintained action, M = Momentary action

#### Lens round, flush, plastic

Lenses are usable for round devices in raised and flush mounting

	Lens	Symbol	Typ-Nr.	
Lens round, flush, plastic	black opaque	without	<b>704.602.0</b>	0.001
	blue transparent	without	<b>704.602.6</b>	0.001
	colourless transparent	Halo	<b>704.602.7A01</b>	0.001
		without	<b>704.602.7</b>	0.001
	green transparent	without	<b>704.602.5</b>	0.001
	red transparent	without	<b>704.602.2</b>	0.001
	yellow transparent	without	<b>704.602.4</b>	0.001



#### Marking plate for Lens round, flush

	Marking plate	Typ-Nr.	
Marking plate for Lens round, flush Halo illumination	Plastic white translucent	<b>704.609.9A01</b>	0.001
LED	Plastic colourless transparent ribbed	<b>704.609.7</b>	0.001
LED and Filament lamp	Plastic white translucent	<b>704.609.9</b>	0.001
non-illuminative	Plastic black opaque	<b>704.609.0</b>	0.001



#### Lens round, metal

	Lens	Ø 29 mm Typ-Nr.	
Lens round, metal	Aluminium black	<b>704.601.0</b>	0.001
	Aluminium blue	<b>704.601.6</b>	0.001
	Aluminium gold	<b>704.601.4</b>	0.001
	Aluminium natural	<b>704.601.8</b>	0.001
	Aluminium olive-green	<b>704.601.5</b>	0.001
	Aluminium red	<b>704.601.2</b>	0.001
	Stainless steel natural	<b>704.601.9</b>	0.001



## Lens round, metal with spot

	Lens	Ø 29 mm Typ-Nr.	
<b>Lens round, metal with spot</b>	Aluminium black	<b>704.601.01</b>	0.001
	Aluminium blue	<b>704.601.61</b>	0.001
	Aluminium gold	<b>704.601.41</b>	0.001
	Aluminium natural	<b>704.601.81</b>	0.001
	Aluminium olive-green	<b>704.601.51</b>	0.001
	Aluminium red	<b>704.601.21</b>	0.001
	Stainless steel natural	<b>704.601.91</b>	0.001



## Front bezel set for Indicator and Pushbutton, flush mounting

	Front bezel	Ø 35 mm Typ-Nr.	Mounting dimensions	
<b>Front bezel set for Indicator and Pushbutton, flush mounting</b>	Aluminium black	<b>704.955.0</b>	7	0.015
	Aluminium natural	<b>704.955.1</b>	7	0.015
	Stainless steel natural	<b>704.955.9</b>	7	0.033



Mounting dimensions from page 91

## Front bezel with protective membrane, flush mounting

for Pushbutton and Illuminated pushbutton (IP 67)

	Front bezel	Ø 35 mm Typ-Nr.	
<b>Front bezel with protective membrane, flush mounting</b> with transparent silicone membrane	Aluminium black	<b>704.955.4</b>	0.015
	Aluminium natural	<b>704.955.3</b>	0.015
with transparent silicone membrane, resistant to sea water	Stainless steel natural	<b>704.955.9E</b>	0.033



Front bezel to be mounted with a torque of 40 Ncm onto actuator.

## Front ring

	Front ring	Ø 29 mm Typ-Nr.	
<b>Front ring</b>	Aluminium black	<b>704.600.1A</b>	0.005
	Aluminium natural	<b>704.600.1</b>	0.005
	Plastic black	<b>704.600.0</b>	0.003
	Plastic light-grey	<b>704.600.6</b>	0.003
	Stainless steel natural	<b>704.600.9</b>	0.006
Heigth 16 mm	Plastic light-grey	<b>704.600.7</b>	0.003



## Front protective cap

for Indicator, Pushbutton and Illuminated pushbutton for protection IP 68

	Front protective cap	Typ-Nr.	
<b>Front protective cap</b> only together with Lenses 704.602.X, 704.601.X and Front rings 704.600.X	Silicone colourless transparent	<b>704.953.0</b>	0.002



## Front protective ring

for Pushbutton and Illuminated pushbutton with front illumination (IP 67)

	Front protective ring	Ø 29 mm Typ-Nr.	
<b>Front protective ring</b> with transparent Pebax membrane, temperature resistance -40 °C ... +85 °C	Aluminium natural	<b>704.600.5/A</b>	0.005
with transparent silicone membrane (extent resistant to sea water), temperature resistance -40 °C ... +85 °C	Aluminium natural	<b>704.600.3</b>	0.005
	Chromed brass	<b>704.600.2</b>	0.005



Front protective ring to be mounted with a torque of 40 Ncm onto actuator.

## Bayonet flange

	Typ-Nr.	Technical drawing	
<b>Bayonet flange</b> Metal	<b>704.960.5</b>	48	0.025
Plastic	<b>704.950.5</b>	47	0.015



Technical drawing from page 95

## Lamp block

	Terminals	Typ-Nr.	Technical drawing	Circuit drawing	
<b>Lamp block</b> Spring terminal	PIT	<b>704.950.3</b>	42	5	0.014
Standard	PT 6.3	<b>704.950.1</b>	40	5	0.012
	ST	<b>704.950.0</b>	39	5	0.012
Terminals Cu/Sn nickel plated	D-PT 6.3	<b>704.950.2/D</b>	41	5	0.013
Terminals Cu/Sn nickel plated and blank	D-PT 6.3	<b>704.950.1/D</b>	41	5	0.013
Terminals for ring cable shoe	ST	<b>704.950.0B</b>	39	5	0.013



Terminals: PIT = PIT Spring terminal, PT 6.3 = Plug-in terminal 6.3 mm, ST = Screw terminal, D-PT 6.3 = Double plug-in terminal 6.3 mm

Technical drawing from page 95, Circuit drawing from page 115

## Pushbutton and Illuminated pushbutton square

### Pushbutton- and Illuminated pushbutton actuator square

	Switching action	Front bezel	Housing	Ø 35 x 35 mm Typ-Nr.	Ø 30 x 30 mm Typ-Nr.	
<b>Pushbutton- and Illuminated pushbutton actuator square</b>	MA	black	Plastic black	<b>704.742.0</b>		0.020
		silver	Plastic black	<b>704.742.8</b>		0.020
	M	black	Plastic black	<b>704.741.0</b>		0.020
		silver	Plastic black	<b>704.741.8</b>		0.020
	MA	without	Plastic black		<b>704.732.0</b>	0.020
			Plastic grey		<b>704.732.1</b>	0.020
	M	without	Plastic black		<b>704.731.0</b>	0.020
			Plastic grey		<b>704.731.1</b>	0.020



Switching action: MA = Maintained action, M = Momentary action

### Lens square, plastic

	Lens	Typ-Nr.	
<b>Lens square, plastic</b>	black opaque	<b>704.702.0</b>	0.001
	blue transparent	<b>704.702.6</b>	0.001
	colourless transparent	<b>704.702.7</b>	0.001
	green transparent	<b>704.702.5</b>	0.001
	red transparent	<b>704.702.2</b>	0.001
	white opaque	<b>704.702.9</b>	0.001
	yellow transparent	<b>704.702.4</b>	0.001



Lenses are usable for square devices in raised and flush mounting

### Lens holder for Lens square

	Lens holder	Typ-Nr.	
<b>Lens holder for Lens square</b> can be marked	translucent white	<b>704.709.9</b>	0.003
LED	transparent colourless	<b>704.709.7</b>	0.003



### Marking foil for Lens square

	Marking foil	Typ-Nr.	
<b>Marking foil for Lens square</b> can be hot stamped	Plastic colourless transparent	<b>704.707.7</b>	0.001



## Front bezel square

	Front bezel	∅ 30 x 30 mm Typ-Nr.	kg
<b>Front bezel square</b>	Plastic black	<b>704.701.0</b>	0.002
	Plastic chromium-plated	<b>704.701.4</b>	0.002
	Plastic grey	<b>704.701.6</b>	0.002



## Bayonet flange

	Typ-Nr.	Technical drawing	kg
<b>Bayonet flange</b> Metal	<b>704.960.5</b>	48	0.025
Plastic	<b>704.950.5</b>	47	0.015



Technical drawing from page 95

## Lamp block

	Terminals	Typ-Nr.	Technical drawing	Circuit drawing	kg
<b>Lamp block</b> Spring terminal	PIT	<b>704.950.3</b>	42	5	0.014
Standard	PT 6.3	<b>704.950.1</b>	40	5	0.012
	ST	<b>704.950.0</b>	39	5	0.012
Terminals Cu/Sn nickel plated	D-PT 6.3	<b>704.950.2/D</b>	41	5	0.013
Terminals Cu/Sn nickel plated and blank	D-PT 6.3	<b>704.950.1/D</b>	41	5	0.013
Terminals for ring cable shoe	ST	<b>704.950.0B</b>	39	5	0.013



Terminals: PIT = PIT Spring terminal, PT 6.3 = Plug-in terminal 6.3 mm, ST = Screw terminal, D-PT 6.3 = Double plug-in terminal 6.3 mm

Technical drawing from page 95, Circuit drawing from page 115

## Snap-action switching element

### Switching system

The double-break, snap-action switching element is equipped with one or two independent contact systems, acting as normally open or normally closed contact. The snap-action switching element is fitted with self-cleaning contacts.

Up to three switching elements can be snapped to each actuator. Snap-action switching elements are not permissible for emergency-stop pushbuttons!

### Material

#### Material of contact

Hardsilver, gold-silver, silver-palladium (for aggressive atmospheres)

#### Switch housing

Polycarbonate (PC)

### Mechanical characteristics

#### Terminals

Screw terminals

Plug-in terminals 6.3 x 0.8 mm

max. wire cross-section 2 x 2.5 mm<sup>2</sup>

max. wire cross-section of stranded cable 2 x 1.5 mm<sup>2</sup>

For switches with plug-in terminals it is necessary to provide insulation sleeves and to maintain a spacing of 65 mm between rows (mounting dimensions)

#### Tightening torque

Screws at the mounting flange max. 25 Ncm

Screws at switching element max. 50 Ncm

#### Actuating force

1 Normally closed 1.9 N

1 Normally open 2 N

#### Actuating travel

5.8 mm ± 0.2 mm

#### Rebound time

≤ 3 ms

#### Mechanical lifetime

(with 1 switching element)

Pushbutton maintained action 1.5 million Cycles of operation

Pushbutton momentary action 3 million Cycles of operation

Selector switch maintained action 1.25 million Cycles of operation

Selector switch momentary action 2.5 million Cycles of operation

Keylock switch maintained action 25 000 Cycles of operation

Keylock switch momentary action 50 000 Cycles of operation

### Electrical characteristics

#### Standards

The switches comply with the "Standards for low-voltage switching devices" EN IEC 60947-5-1

#### Rated Insulation Voltage U<sub>i</sub>

500 VAC / 600 VDC, as per EN IEC 60947-5-1

#### Contact resistance

New state ≤ 50 mΩ as per DIN IEC 60512-2-4

#### Isolation resistance

≥ 10 MΩ between open contacts at 500 VDC, as per DIN IEC 60512-2-10

#### Electrical life

50 000 cycles of operations

#### Conventional free air thermal current I<sub>th</sub>

10 A, as per EN IEC 60947-5-1

the maximum current in continuous operation and at ambient temperature must not exceed the quoted maximum values.

#### Switch rating

At switch rating AC for gold-silver, silver-palladium and hardsilver contacts, service category AC-15, as per EN IEC 60947-5-1 (cosφ 0.3)

Voltage	230 VAC	400 VAC	500 VAC
Current	6 A	4 A	2.5 A

At switch rating DC for gold-silver and hardsilver contacts, service category DC-13, as per EN IEC 60947-5-1

Voltage	24 VDC	60 VDC	110 VDC
Current	10 A	3 A	1 A

#### Recommended minimum operational data

Gold-silver contacts:

Voltage	5 VDC	24 VDC	110 VDC
Current	15 mA	5 mA	2 mA

Hardsilver contacts:

Voltage	24 VDC	110 VDC
Current	50 mA	10 mA

#### Protection class

Indicators and switches, fit for mounting into devices with protection class II

### Environmental conditions

#### Storage temperature

-40 °C ... +85 °C

#### Operating temperature

-40 °C ... +55 °C

#### Protection degree

IP 20

#### Shock resistance

(single impacts, semi-sinusoidal)

300 m/s<sup>2</sup>puls width 11 ms, as per EN IEC 60068-2-27

#### Vibration resistance

(sinusoidal)

100 m/s<sup>2</sup> at 10 Hz ... 500 Hz, amplitude 0,75 mm, as per EN IEC 60068-2-6

### Approvals

#### Approbations

CB (IEC 60947)

CCC

CSA

Germanischer Lloyd

GOST

NFF 16-102

SEV

UL

**Declaration of conformity**  
CE

## Slow-make switching element

### Switching system

The double-break, slow-make switching element is equipped with one or two independent contact systems, acting as normally open or normally closed contact. The normally closed contact has forced opening.

Slow-make contacts with forced action are ideal for high switch ratings.

Up to three switching elements can be snapped to each actuator. For the emergency-stop pushbutton use the slow-make switching element (max. 2).

### Material

#### Material of contact

Hardsilver, gold-silver, silver-palladium (for aggressive atmospheres)

#### Switch housing

Polycarbonate (PC)

### Mechanical characteristics

#### Terminals

Screw terminals

Plug-in terminals 6.3 x 0.8 mm

max. wire cross-section 2 x 2.5 mm<sup>2</sup>

max. wire cross-section of stranded cable 2 x 1.5 mm<sup>2</sup>

For switches with plug-in terminals it is necessary to provide insulation sleeves and to maintain a spacing of 65 mm between rows (mounting dimensions)

#### Tightening torque

Screws at the mounting flange max. 25 Ncm

Screws at switching element max. 50 Ncm

#### Actuating force

1 Normally closed 2 N

1 Normally open 3.1 N

#### Actuating travel

5.8 mm ± 0.2 mm

#### Rebound time

≤1 ms

#### Mechanical lifetime

(with 1 switching element)

Pushbutton maintained action	1.5 million	Cycles of operation
Pushbutton momentary action	3 million	Cycles of operation
Selector switch maintained action	1.25 million	Cycles of operation
Selector switch momentary action	2.5 million	Cycles of operation
Emergency-stop switch	50 000	Cycles of operation
Keylock switch maintained action	25 000	Cycles of operation
Keylock switch momentary action	50 000	Cycles of operation

### Electrical characteristics

#### Standards

The switches comply with the "Standards for low-voltage switching devices" EN IEC 60947-5-1

#### Rated Insulation Voltage U<sub>i</sub>

500 VAC / 600 VDC, as per EN IEC 60947-5-1

#### Contact resistance

New state ≤50 mΩ as per DIN IEC 60512-2-4

#### Isolation resistance

≥10 MΩ between open contacts at 500 VDC, as per DIN IEC 60512-2-10

#### Electrical life

50 000 cycles of operations

#### Conventional free air thermal current I<sub>th</sub>

10 A, as per EN IEC 60947-5-1

the maximum current in continuous operation and at ambient temperature must not exceed the quoted maximum values.

#### Switch rating

At switch rating AC for gold-silver, silver-palladium and hardsilver contacts, service category AC-15, as per EN IEC 60947-5-1 (cosφ 0.3)

Voltage	230 VAC	400 VAC	500 VAC
Current	7 A	5 A	4 A

At switch rating DC for gold-silver and hardsilver contacts, service category DC-13, as per EN IEC 60947-5-1

Voltage	24 VDC	60 VDC	110 VDC	250 VDC
Current	10 A	5 A	2.5 A	0.6 A

#### Recommended minimum operational data

Gold-silver contacts:

Voltage	24 VDC	110 VDC
Current	10 mA	2 mA

Hardsilver contacts:

Voltage	24 VDC	110 VDC
Current	50 mA	10 mA

#### Protection class

Indicators and switches, fit for mounting into devices with protection class II

### Environmental conditions

#### Storage temperature

-40 °C ... +85 °C

#### Operating temperature

-40 °C ... +55 °C

#### Protection degree

IP 20

#### Shock resistance

(single impacts, semi-sinusoidal)

300 m/s<sup>2</sup>puls width 11 ms, as per EN IEC 60068-2-27

#### Vibration resistance

(sinusoidal)

100 m/s<sup>2</sup> at 10 Hz ... 500 Hz, amplitude 0,75 mm, as per EN IEC 60068-2-6

### Approvals

#### Approbations

CB (IEC 60947)

CCC

CSA

Germanischer Lloyd

GOST

NFF 16-102



SEV  
UL

**Declaration of conformity**  
CE

## Snap-action switching element PIT

### Switching system

The double-break, snap-action switching element is equipped with one or two independent contact systems, acting as normally open or normally closed contact. The snap-action switching element is fitted with self-cleaning contacts.

Up to three switching elements can be snapped to each actuator. Snap-action switching elements are not permissible for emergency-stop pushbuttons!

### Material

**Material of contact**  
Hardsilver and gold-silver

**Switch housing**  
Polycarbonate (PC)

### Mechanical characteristics

#### Terminals

PIT Spring terminal  
Skinning 8 mm  
Wire cross-section:  
Wire 0.2 to 1.0 mm<sup>2</sup> Stranded wire 0.2 to 1.0 mm<sup>2</sup> without core and sleeve  
Stranded wire 0.2 to 0.75 mm<sup>2</sup> with core and sleeve

#### Tightening torque

Screws at the mounting flange max. 25 Ncm

#### Actuating force

1 Normally closed 1.9 N  
1 Normally open 2 N

#### Actuating travel

5.8 mm ± 0.2 mm

#### Rebound time

≤ 3 ms

#### Mechanical lifetime

(with 1 switching element)

Pushbutton maintained action	1.5 million	Cycles of operation
Pushbutton momentary action	3 million	Cycles of operation
Selector switch maintained action	1.25 million	Cycles of operation
Selector switch momentary action	2.5 million	Cycles of operation
Emergency-stop switch	50 000	Cycles of operation
Keylock switch maintained action	25 000	Cycles of operation
Keylock switch momentary action	50 000	Cycles of operation

### Electrical characteristics

#### Standards

The switches comply with EN IEC 60947-1 / EN IEC 60947-5-1

#### Rated Insulation Voltage $U_i$

500 VAC / 600 VDC, as per EN IEC 60947-5-1

#### Contact resistance

New state ≤ 50 mΩ as per DIN IEC 60512-2-4

#### Isolation resistance

≥ 10 MΩ between open contacts at 500 VDC, as per DIN IEC 60512-2-10

#### Electrical life

50 000 cycles of operations

#### Conventional free air thermal current $I_{th}$

6 A, as per EN IEC 60947-5-1  
the maximum current in continuous operation and at ambient temperature must not exceed the quoted maximum values.

#### Switch rating

At switch rating AC for gold-silver and hardsilver contacts, service category AC-15, as per EN IEC 60947-5-1 (cosφ 0.3)

Voltage 250 VAC  
Current 6 A

At switch rating DC for gold-silver and hardsilver contacts, service category DC-13, as per EN IEC 60947-5-1

Voltage 24 VDC 110 VDC  
Current 6 A 1.0 A

#### Recommended minimum operational data

Gold-silver contacts:

Voltage 24 VDC  
Current 5 mA

Hardsilver contacts:

Voltage 24 VDC  
Current 50 mA

#### Protection class

Indicators and switches, fit for mounting into devices with protection class II

### Environmental conditions

#### Storage temperature

-40 °C ... +85 °C

#### Operating temperature

-40 °C ... +55 °C

#### Protection degree

IP 20

#### Shock resistance

(single impacts, semi-sinusoidal)  
300 m/s<sup>2</sup> puls width 11 ms, as per EN IEC 60068-2-27

#### Vibration resistance

(sinusoidal)  
100 m/s<sup>2</sup> at 10 Hz ... 500 Hz, as per EN IEC 60068-2-6 and EN 61373 Increased broad band noise, class 1B

### Approvals

#### Approbations

CB (IEC 60947)  
CCC  
CSA  
Germanischer Lloyd  
GOST  
NFF 16-102

#### Declaration of conformity

CE

## Slow-make switching element PIT

### Switching system

The double-break, slow-make switching element is equipped with one or two independent contact systems, acting as normally open or normally closed contact. The normally closed contact has forced opening.

Slow-make contacts with forced action are ideal for high switch ratings.

Up to three switching elements can be snapped to each actuator. For the emergency-stop pushbutton use the slow-make switching element (max. 2).

### Material

#### Material of contact

Hardsilver and gold-silver

#### Switch housing

Polycarbonate (PC)

### Mechanical characteristics

#### Terminals

PIT Spring terminal

Skinning 8 mm

Wire cross-section:

Wire 0.2 to 1.0 mm<sup>2</sup> Stranded wire 0.2 to 1.0 mm<sup>2</sup> without core and sleeve

Stranded wire 0.2 to 0.75 mm<sup>2</sup> with core and sleeve

#### Tightening torque

Screws at the mounting flange max. 25 Ncm

#### Actuating force

1 Normally closed 2 N

1 Normally open 3.1 N

#### Actuating travel

5.8 mm ± 0.2 mm

#### Rebound time

≤1 ms

#### Mechanical lifetime

(with 1 switching element)

Pushbutton maintained action 1.5 million Cycles of operation

Pushbutton momentary action 3 million Cycles of operation

Selector switch maintained action 1.25 million Cycles of operation

Selector switch momentary action 2.5 million Cycles of operation

Emergency-stop switch 50 000 Cycles of operation

Keylock switch maintained action 25 000 Cycles of operation

Keylock switch momentary action 50 000 Cycles of operation

### Electrical characteristics

#### Standards

The switches comply with EN IEC 60947-1 / EN IEC 60947-5-1

#### Rated Insulation Voltage $U_i$

500 VAC / 600 VDC, as per EN IEC 60947-5-1

#### Contact resistance

New state ≤50 mΩ as per DIN IEC 60512-2-4

#### Isolation resistance

≥10 MΩ between open contacts at 500 VDC, as per DIN IEC 60512-2-10

### Electrical life

50 000 cycles of operations

### Conventional free air thermal current $I_{th}$

6 A, as per EN IEC 60947-5-1

the maximum current in continuous operation and at ambient temperature must not exceed the quoted maximum values.

### Switch rating

At switch rating AC for gold-silver and hardsilver contacts, service category AC-15, as per EN IEC 60947-5-1 (cosφ 0.3)

Voltage 250 VAC

Current 6 A

At switch rating DC for gold-silver and hardsilver contacts, service category DC-13, as per EN IEC 60947-5-1

Voltage 24 VDC 110 VDC

Current 6 A 1.0 A

### Recommended minimum operational data

Gold-silver contacts:

Voltage 24 VDC

Current 5 mA

Hardsilver contacts:

Voltage 24 VDC

Current 50 mA

### Protection class

Indicators and switches, fit for mounting into devices with protection class II

### Approvals

#### Approbations

CB (IEC 60947)

CCC

CSA

Germanischer Lloyd

GOST

NFF 16-102

#### Declaration of conformity

CE

## Lamp block PIT

### Material

#### Housing

Polycarbonate (PC)

### Mechanical characteristics

#### Terminals

PIT Spring terminal

Skinning 8 mm

Wire cross-section:

Wire 0.2 to 1.0 mm<sup>2</sup> Stranded wire 0.2 to 1.0 mm<sup>2</sup> without core and sleeve

Stranded wire 0.2 to 0.75 mm<sup>2</sup> with core and sleeve

### Electrical characteristics

#### Standards

The switches comply with EN IEC 60947-1 / EN IEC 60947-5-1

## Illumination

Voltage 250 V max.  
Power 2.6 W max.  
BA9s standard adaptable.

## Environmental conditions

### Storage temperature

-40 °C ... +85 °C

### Operating temperature

-40 °C ... +55 °C

### Protection degree

IP 20

### Shock resistance

(single impacts, semi-sinusoidal)  
300 m/s<sup>2</sup>puls width 11 ms, as per EN IEC 60068-2-27

### Vibration resistance

(sinusoidal)  
100 m/s<sup>2</sup> at 10 Hz ... 500 Hz, as per EN IEC 60068-2-6 and EN 61373 Increased broad band noise, class 1B

## Buzzer

## Buzzer system

### System

Piezo disc

## Material

### Alarm buzzer case

Polyamide

### Front cap

Plastic Polyamide  
Metal Nickel-plated brass (sea-water proof)

## Mechanical characteristics

### Terminals

Plug-in terminal 2.8 x 0.5 mm

## Electrical characteristics

### Frequency (tone)

approx. 2.8 kHz continuous tone only

### Sound pressure

95 db (A) ±8 dB at a distance of 0.1 m

### Operation Voltage/Current

Operation Voltage 24 VDC ±10 %  
Operation Current ≤25 mA

## Environmental conditions

### Storage temperature

-40 °C ... +85 °C

### Operating temperature

-25 °C ... +55 °C

### Protection degree

as per EN IEC 60529, frontside

IP 40, devices flush mounting

IP 65, devices raised mounting

## Approvals

### Declaration of conformity

CE

## Actuator

## Material

### Front ring

Polyamide, Aluminium or Stainless steel

### Mounting flange

Polyethylene terephthalate

### Actuator housing

Polycarbonate, Polyamide

## Mechanical characteristics

### Actuating force

Mounting style square flush 6.2 N  
other Mounting styles 8 N

### Actuating travel

5.8 mm ± 0.2 mm

### Mechanical lifetime

(with 1 switching element)

Pushbutton	≤3 million	Cycles of operation
Selector switch	≤2.5 million	Cycles of operation
Stop switch	≤50 000	Cycles of operation
Fool proofed E-stop	≥6050	Cycles of operation
Keylock switch	≤50 000	Cycles of operation
Key insert switches	≤250 000	Cycles of operation

## Electrical characteristics

### Standards

The switches comply with the "Rules for low-voltage switching devices" EN IEC 60947-5-1

## Environmental conditions

### Storage temperature

-40 °C ... +85 °C

### Operating temperature

-25 °C ... +55 °C  
-40 °C ... +55 °C (Key insert switch)

### Protection degree

as per EN IEC 60529  
frontside IP 65 (IP 67 Key insert switch)

## Rotary selector switch element

## Mechanical characteristics

### Terminals

Screw terminals  
Terminal lead material copper wires only  
max. permissible wire gage :  
Single-core or stranded wire 2 x 1.5 mm<sup>2</sup> (2 x AWG 14)  
flexible wire 2 x 1,5 mm<sup>2</sup> (2 x AWG 16)

## Number of stages

1 to 8 positions max.

## Number of contacts

1 to 16 max. normally open contacts  
(contact positioning according circuit drawing)

## Switching angle

Basic position of switching position "a" is 9 o'clock

Maintained action    Switching angle

12 max.                30 °

8 max.                 45 °

6 max.                 60 °

4 max.                 90 °

Momentary action with release 24 °

(provide at the beginning or at the end )

## Standard type of Kraus & Naimer

CG4 Hard Silver contacts with 1 µm Gold layer

CG4-1 Hard Silver contacts with 35 µm Gold layer

## Electrical characteristics

### Minimum Voltage

20 V

### Rated Impulse Withstand Voltage $U_{imp}$

4 kV

### Short Circuit Protection

Max. fuse size (gL- characteristic) 10 A

Rated short-time withstand current (1s-current) 90 A

## Electrical characteristics for AC

### Standards

The devices comply with : EN IEC 60947-3, VDE 0660 part 107

### Rated Operational Voltage $U_e$

440 V

### Rated Insulation Voltage $U_i$

440 V

### Rated Thermal Current $I_U/I_{th}$

10 A

### Rated Operational Current $I_e$

AC-15 Switching of control devices, contactors, valves etc.

110 V - 120 V    2.5 A

220 V - 240 V    2.5 A

380 V - 440 V    1.5 A

No load operation

10 A

AC-21A Switching of resistive loads, including moderate overloads

For switchin of power >1 kW

10 A

AC-22A Switching of combined resistive or low inductive loads including moderate overloads

220 V - 240 V    10 A

### Rated Utilization Category

AC-2 Slip ring motor starting, reversing and plugging, star-delta starting 3 phase, 3 pole

220 V - 240 V    2.5 kW

380 V - 440 V    4.5 kW

AC-3 Direct-on-line starting, star-delta starting

3 phase, 3 pole    220 V - 240 V    2.5 kW

380 V - 440 V    2.2 kW

1 phase, 2 pole    110 V - 120 V    0.3 kW

220 V - 240 V    0.55 kW

380 V - 440 V    0.75 kW

AC-Direct-on-line starting, reversing, plugging and inching

3 phase, 3 pole    220 V - 240 V    0.37 kW

380 V - 440 V    0.55 kW

1 phase, 2 pole    110 V - 120 V    0.15 kW

220 V - 240 V    0.25 kW

380 V - 440 V    0.5 kW

AC-23A Frequent switching of motors or other high inductive loads

3 phase, 3 pole    220 V - 240 V    1.8 kW

380 V - 440 V    3 kW

1 phase, 2 pole    110 V - 120 V    0.37 kW

220 V - 240 V    0.75 kW

380 V - 440 V    1.1 kW

### Overvoltage category

III, valid for lines with grounded common neutral termination

### Degree of pollution

3, valid for lines with grounded common neutral termination

## Electrical characteristics for AC (UL/Canada)

### Rated operational voltage

300 V

### Rated Insulation Voltage $U_i$

300 V

### Rated Thermal Current

10 A

### Ampere Rating

Resistive or low inductive loads, for switching of power >1 kW, 10 A

### Ratings

Standard motor load, DOL Rating (similar AC-3)

3 phase, 3 pole    110 V - 120 V    0.75 HP

220 V - 240 V    1 HP

1 phase, 2 pole    110 V - 120 V    0.33 HP

220 V - 240 V    0.75 HP

277 V - 277 V    0.75 HP

### Pilot Duty, Heavy

300 VAC

## Electrical characteristics for DC

### Switch Rating DC

Resistive loads  $T \leq 1$  ms

Number of series contact(s)

1	2	3	4	5	6	8	Switch Capacity
24 V	48 V	70 V	95 V	120 V	145 V	190 V	10 A

48 V	95 V	140 V	190 V	240 V	290 V	350 V	6 A
60 V	120 V	180 V	240 V	300 V	360 V	450 V	2.5 A
110 V	220 V	330 V	440 V	550 V	660 V		0.7 A
220 V	440 V	660 V					0.3 A
440 V	660 V						0.2 A

Inductive loads T = 50 ms

Number of series contact(s)							Switch
1	2	3	4	5	6	8	Capacity
24 V	48 V	70 V	95 V	120 V	145 V	190 V	6 A
30 V	60 V	90 V	120 V	150 V	180 V	240 V	3 A
48 V	95 V	140 V	190 V	240 V	290 V	350 V	1 A
60 V	120 V	180 V	240 V	300 V	360 V	450 V	0.7 A
110 V	220 V	330 V	440 V	550 V	660 V		0.3 A

## Environmental conditions

### Operating temperature

Ambient Temperatures of Stages

open at 100 % $I_U/I_{th}$	55 °C during 24 h with peaks up to 60 °C
enclosed at 100 % $I_{th}$	35 °C during 24 h with peaks up to 40 °C

## Flasher element

Do not connect terminal c and f simultaneously when powered up.



## Suppressor circuits

When switching inductive loads such as relays, DC motors, and DC solenoids, it is always important to absorb surges (e.g. with a diode) to protect the contacts. When these inductive loads are switched off, a counter emf can severely damage switch contacts and greatly shorten lifetime.

Fig. 1 shows an inductive load with a free-wheeling diode connected in parallel. This free-wheeling diode provides a path for the inductor current to flow when the current is interrupted by the switch. Without this free-wheeling diode, the voltage across the coil will be limited only by dielectric breakdown voltages of the circuit or parasitic elements of the coil. This voltage can be kilovolts in amplitude even when nominal circuit voltages are low (e.g. 12 VDC) see Fig. 2.

The free-wheeling diode should be chosen so that the reverse breakdown voltage is greater than the voltage driving the inductive load. The DC blocking voltage ( $V_R$ ) of the free-wheeling diode can be found in the datasheet of a diode. The forward current should be equal or greater than the maximum current flowing through the load.

**To get an efficient protection, the free-wheeling diode must be connected as close as possible to the inductive load!**

Switching with inductive load  
Fig. 1



Counter emf  
over load without free-wheeling diode  
Fig. 2



## General notes

### 1. Engraving

In addition to the most commonly used world languages, in DIN 1451-3 close spacing, other typefaces are available as Scandinavian, Slavic, Greek, Russian and Polish.

The lenses are filled with black or white colour. Standard height of letters is 3 mm. If the height is not specified, we will supply 3 mm engraved letters.

### 2. Hot stamping

Standard legends and ISO symbols are hot stamped. For larger series it is worth considering markings by means of hot stamping. We will be pleased to advise you.

### 3. Film inserts

Instead of using engraving the square lenses can be fitted with film inserts, as an alternative. Film thickness is 0.25 mm.

Max. film size :

for Indicator 24.5 mm x 24.5 mm

for illuminated Pushbutton 21.5 x 21.5 mm.

## Engraving marking cap for Indicator round, full face illumination

All dimensions in mm

Height of letters	Number of lines	Number of (target value) letters per line			Line spacing
		b1	b2	b3	d
3	3	11	10	9	4.6
4	2	8	7	-	6.6
8	1	4	-	-	-



The gap between 2 words results in each case a letter less.

## Engraving marking cap for Indicator and illuminated Pushbutton round, front illumination

All dimensions in mm

Height of letters	Number of lines	Number of (target value) letters per line			Line spacing
		b1	b2	b3	d
3	3	9	9	7	4.6
4	2	7	6	-	6.6
8	1	3	-	-	-



The gap between 2 words results in each case a letter less.



## Engraving diffusor cap for Indicator square, full face illumination

All dimensions in mm

Height of letters h	Number of lines	Number of (target value) capital letters per line	Number of (target value) small letters per line
2.5	6	13	14
3.0	5	11	12
4.0	4	8	8 - 9
5.0	3	6 - 7	7
6.0	2	5 - 6	6
8.0	1	4	4 - 5



The gap between 2 words results in each case a letter less.

## Engraving lens holder for Indicator and Illuminate Pushbutton square, front illumination

All dimensions in mm

Height of letters h	Number of lines	Number of (target value) capital letters per line	Number of (target value) small letters per line
2.5	5	9	9 - 10
3.0	4	7 - 8	8
4.0	3	5 - 6	6
5.0	2	4 - 5	4 - 5
6.0	2	3 - 4	4
8.0	1	2 - 3	3



The gap between 2 words results in each case a letter less.

Important : Consider lens holder mounting orientation before specifying engraving characters !

## Engraving legend plates

All dimensions in mm

Dimension	Devices mounting style	Height of letters h	Number of lines	Number of (target value) letters per line	Image
30 x 50	round, raised	3	2	12	B1
		4	1	7	B1
		8	1	4	B1
35 x 57.5	round, flush	3	2	12	B2
		4	1	7	B2
		8	1	4	B2
18 x 35	square, flush	3	3	16	B3
		4	2	10	B3
		8	1	6	B3

B1



B2



B3



The gap between 2 words results in each case a letter less.

## Standard texts for marking plates and marking caps for Indicator and Illuminated Pushbutton

Height of letters 6 mm



























## Symbols for marking plates and marking caps for Indicator and Illuminated Pushbutton

	1 Direction of linear rectilinear motion (also for $\rightarrow \updownarrow$ )		13 Direction of spindle rotation		29 Decrease of value (speed, for instance)		49 Cooling pump
	2 Linear motion in 2 directions (also for $\updownarrow$ )		14 One revolution		30 Speed of planing cut		50 Lubricant pump
	3 Interrupted linear motion (also for $\leftarrow \updownarrow$ )		15 Number of revolutions per minute (spindle speed)		31 Speed of turning cut		51 Hydraulic system pump
	4 Limited linear motion (also for $\leftarrow \updownarrow$ )		16 Feed		32 Speed of drilling cut		52 Hydraulic motor
	5 Limited linear motion and return		17 Feed per revolution		33 Speed of milling cut (similar symbol for speed of grinding)		53 Tracer
	6 Oscillating linear motion (continuous)		18 Feed per minute		34 Conventional milling		61 Stepless regulation
	7 Direction of continuous rotation (right)		19 Reduced feed		35 Climb milling (down milling)		62 Adjustable
	7a Direction of continuous rotation (left)		20 Rapid feed		41 Electric motor		63.1 Lock or tighten
	8 Rotation in 2 directions		21 Normal feed		42 Rectangular work table or slide element		63.2 Lock or tighten
	9 Direction of interrupted rotation (right)		22 Direction of feed (orientation not specified)		43 Round work table or rotating element		64.1 Unlock, unclamp
	9a Direction of interrupted rotation (left)		24 Transverse feed		44 Turning spindle		64.2 Chuck open
	10 Limited rotation (right)		25 Vertical feed		45 Drilling spindle		65 Brake on
	10a Limited rotation (left)		26 Rapid traverse		46 Milling spindle		66 Brake off
	11 Limited rotation and return		27 Threading		47 Grinding spindle		67 Automatic (or semi-automatic) cycle
	12 Oscillating rotary movement (continuous)		28 Increase of value (speed, for instance)		48 Pump (general symbol)		68 Hand control

Continuation see next page

Continued from previous page

 69 Start, on	 77 Open lock-nut	 93 Caution!	 106 Drain
 70 Stop, off	 78 Engage sensor	 94 Main switch	 107 Oil, lubricant
 71 Start and stop with same button	 79 Disengage sensor	 101 Coolant fluid	 108 Blast
 72 In action as long as button is operated	 80 Change speed only in stopped position	 102 Machine lighting	 109 Suction
 74 Engaging (mechanical start)	 81 Change speed only in motion	 103 Weight	
 75 Disengaging (mechanical stop)	 91 Shear pin construction	 104 Filter opening	
 76 Close lock-nut	 92 Danger (high voltage)	 105 Overflow	

## Mounting dimensions

1 Rotary selector switch actuator, short lever, flush mounting page 44 | Rotary selector switch actuator, long lever, flush mounting page 44



2 Emergency-stop pushbutton actuator, foolproof EN IEC 60947-5-5 page 21



3 Indicator full-face illumination compact page 12



Hole spacing 31 mm min. by using blind plug 704.960.4

4 Rotary selector switch actuator, short lever page 31 | Rotary selector switch actuator, long lever page 31



5 Indicator full face illumination page 13 | Indicator front illumination page 14 | Flasher full face illumination page 15 | Flasher front illumination page 16 | Buzzer page 17 | Pushbutton actuator page 18 | Illuminated pushbutton actuator page 20 | Keylock switch actuator 2 positions page 25 | Keylock switch actuator 3 positions page 26 | Selector switch actuator 2 positions, short lever page 27 | Selector switch actuator 2 positions, short lever, 12 o'clock page 27 | Selector switch actuator 3 positions, short lever page 29



Hole spacing 31 mm min. by using blind plug 704.960.4

6 Selector switch actuator 2 positions, long lever page 28 | Selector switch actuator 2 positions, long lever, 12 o'clock page 28 | Selector switch actuator 3 positions, long lever page 30



7 Indicator, flush mounting page 32 | Flasher, flush mounting page 33 | Buzzer, flush mounting page 33 | Pushbutton actuator, flush mounting page 34 | Illuminated pushbutton actuator, flush mounting page 36 | Keylock switch actuator 2 positions, flush mounting page 38 | Keylock switch actuator 3 positions, flush mounting page 39 | Selector switch actuator 2 positions, short lever, flush mounting page 40 | Selector switch actuator 2 positions, short lever, 12 o'clock, flush mounting page 40 | Selector switch actuator 2 positions, long lever, flush mounting page 41 | Selector switch actuator 2 positions, long lever, 12 o'clock, flush mounting page 41 | Selector switch actuator 3 positions, short lever, flush mounting page 42 | Keylock rotary switch actuator, flush mounting page 45 | Front bezel set for Indicator and Pushbutton, flush mounting page 68 | Front bezel set for Indicator and Pushbutton, flush mounting page 73



8 Selector switch actuator 3 positions, long lever, flush mounting page 43



**9 Stop pushbutton actuator** page 22 | **Mushroom-head pushbutton actuator** page 23 | **Mushroom-head pushbutton actuator illuminated** page 24



**10 Stop pushbutton actuator, flush mounting** page 37 | **Mushroom-head pushbutton actuator, flush mounting** page 37



**11 Key insert switch actuator 2 positions, flush mounting** page 45 | **Key insert switch actuator 3 positions, flush mounting** page 46



**12 Indicator, flush mounting** page 32 | **Flasher, flush mounting** page 33 | **Pushbutton actuator, flush mounting** page 34 | **Illuminated pushbutton actuator, flush mounting** page 36 | **Keylock switch actuator 2 positions, flush mounting** page 38 | **Keylock switch actuator 3 positions, flush mounting** page 39 | **Selector switch actuator 2 positions, short lever, flush mounting** page 40 | **Selector switch actuator 2 positions, short lever, 12 o'clock, flush mounting** page 40 | **Selector switch actuator 3 positions, short lever, flush mounting** page 42



13 Selector switch actuator 2 positions, long lever, flush mounting page 41 | Selector switch actuator 2 positions, long lever, 12 o'clock, flush mounting page 41 | Selector switch actuator 3 positions, long lever, flush mounting page 43



14 Rotary selector switch actuator, short lever, flush mounting page 44 | Rotary selector switch actuator, long lever, flush mounting page 44



15 Key insert switch actuator 3 positions Conductor Switch, flush mounting page 46





## Technical drawing

1 Key insert switch actuator 2 positions, flush mounting page 45 | Key insert switch actuator 3 positions, flush mounting page 46



2 Indicator full-face illumination compact page 12



3 Indicator full face illumination page 13



## 4 Pushbutton actuator page 18



## 5 Indicator front illumination page 14



## 6 Flasher full face illumination page 15



## 7 Flasher front illumination page 16



## 8 Illuminated pushbutton actuator page 20



## 9 Keylock switch actuator 2 positions page 25 | Keylock switch actuator 3 positions page 26



10 Selector switch actuator 2 positions, long lever page 28 | Selector switch actuator 2 positions, long lever, 12 o'clock page 28 | Selector switch actuator 3 positions, long lever page 30



11 Selector switch actuator 2 positions, short lever page 27 | Selector switch actuator 2 positions, short lever, 12 o'clock page 27 | Selector switch actuator 3 positions, short lever page 29



12 Stop pushbutton actuator page 22



**13 Mushroom-head pushbutton actuator illuminated** page 24



**14 Emergency-stop pushbutton actuator, foolproof EN IEC 60947-5-5** page 21

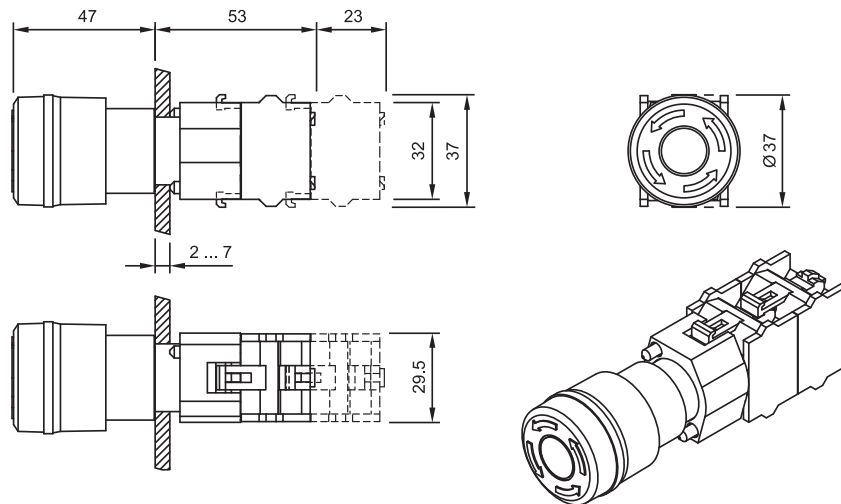

**15 Mushroom-head pushbutton actuator** page 23



**16 Selector switch actuator 2 positions, long lever, flush mounting page 41 | Selector switch actuator 2 positions, long lever, 12 o'clock, flush mounting page 41 | Selector switch actuator 3 positions, long lever, flush mounting page 43**



**17 Stop pushbutton actuator page 22**



**18 Buzzer page 17**



## 19 Illuminated pushbutton actuator, flush mounting page 36



## 20 Indicator, flush mounting page 32



## 21 Flasher, flush mounting page 33



## 22 Pushbutton actuator, flush mounting page 34



## 23 Selector switch actuator 2 positions, short lever, flush mounting page 40 | Selector switch actuator 2 positions, short lever, 12 o'clock, flush mounting page 40 | Selector switch actuator 3 positions, short lever, flush mounting page 42 | Selector switch actuator 3 positions, long lever, flush mounting page 43



## 24 Emergency-stop pushbutton actuator, foolproof EN IEC 60947-5-5 page 21





**25 Keylock switch actuator 2 positions, flush mounting page 38 | Keylock switch actuator 3 positions, flush mounting page 39**



**26 Stop pushbutton actuator, flush mounting page 37**



**27 Mushroom-head pushbutton actuator, flush mounting page 37**



**28 Switching element** page 51 | **Switching element for Emergency-stop pushbutton** page 54



**29 Switching element** page 51 | **Switching element for ring cable shoe** page 53 | **Switching element for Emergency-stop pushbutton** page 54



**30 Switching element** page 51 | **Switching element for Emergency-stop pushbutton** page 54



**31 Switching element** page 51 | **Switching element for Emergency-stop pushbutton** page 54



**32 Flasher element** page 50



**33 Lamp transformer** page 59



**34 Diode block** page 58 | **Resistor block** page 59 | **Resistor-diode block** page 59



**35 Terminal cover** page 56



**36 Mounting plate** page 61



**37 Snap-on base** page 62



**38 Snap-on base** page 62



**39 Lamp block** page 65 | **Lamp block** page 67 | **Lamp block** page 70 | **Lamp block** page 71 | **Lamp block** page 74 | **Lamp block** page 76



**40 Lamp block** page 65 | **Lamp block** page 67 | **Lamp block** page 70 | **Lamp block** page 71 | **Lamp block** page 74 | **Lamp block** page 76



**41 Lamp block** page 65 | **Lamp block** page 67 | **Lamp block** page 70 | **Lamp block** page 71 | **Lamp block** page 74 | **Lamp block** page 76



42 Lamp block page 65 | Lamp block page 67 | Lamp block page 70 | Lamp block page 71 | Lamp block page 74 | Lamp block page 76



43 Blind plug page 49



44 Blind plug page 49



45 Blind plug page 49



46 Blind plug page 49



47 Bayonet flange page 65 | Bayonet flange page 66 | Bayonet flange page 69 | Bayonet flange page 71 | Bayonet flange page 74 | Bayonet flange page 76



48 Bayonet flange page 65 | Bayonet flange page 66 | Bayonet flange page 69 | Bayonet flange page 71 | Bayonet flange page 74 | Bayonet flange page 76



49 Protective cover page 48



Front panel thickness reduces by 3.5 mm to max. 4.5 mm

50 Protective cover, flush mounting page 49



Front panel thickness reduces by 2.5 mm to max. 3.5 mm

51 Protective cover page 48



Front panel thickness reduces by 3.5 mm to max. 4.5 mm

## 52 Protective cover, flush mounting page 49



Front panel thickness reduces by 2.5 mm to max. 3.5 mm

## 53 Protective cover, flush mounting page 49



Front panel thickness reduces by 2.5 mm to max. 3.5 mm

## 54 Protective cover, flush mounting page 49



## 55 Legend frame page 48



**56 Key insert switch actuator 3 positions Conductor Switch, flush mounting page 46**



**57 Reducing ring page 61**



**58 Emergency-stop protective shroud page 60**



**59 Emergency-stop protective shroud page 60**



60 Legend frame page 48



61 Emergency-stop enclosures page 60



62 Emergency-stop enclosures page 60





63 Emergency-stop enclosures page 60 | Enclosure page 63



64 Enclosure page 63



65 Enclosure page 63



66 Enclosure page 63



67 Enclosure page 63



68 Buzzer, flush mounting page 33



## 69 Rotary selector switch actuator, short lever page 31



## 70 Rotary selector switch actuator, long lever page 31



## 71 Rotary selector switch actuator, short lever, flush mounting page 44



## 72 Rotary selector switch actuator, long lever, flush mounting page 44



Stages	L
1	78.5
2	90.5
3	102.5
4	114.5
5	126.5
6	138.5
7	150.5
8	162.5

## 73 Keylock rotary switch actuator, flush mounting page 45



Stages	L
1	85.5
2	97.5
3	109.5
4	121.5
5	133.5
6	145.5
7	157.5
8	169.5

## Circuit drawing

1 Buzzer page 17 | Buzzer, flush mounting page 33



2 Diode block page 58



3 Pushbutton actuator page 18 | Mushroom-head pushbutton actuator page 23 | Pushbutton actuator, flush mounting page 34 | Illuminated pushbutton actuator, flush mounting page 36 | Mushroom-head pushbutton actuator, flush mounting page 37



4 Pushbutton actuator page 18 | Mushroom-head pushbutton actuator page 23 | Pushbutton actuator, flush mounting page 34 | Illuminated pushbutton actuator, flush mounting page 36 | Mushroom-head pushbutton actuator, flush mounting page 37



**5 Indicator full-face illumination compact** page 12 | **Indicator full face illumination** page 13 | **Indicator front illumination** page 14 | **Flasher full face illumination** page 15 | **Flasher front illumination** page 16 | **Indicator, flush mounting** page 32 | **Flasher, flush mounting** page 33 | **Indicator actuator for Indicator compact** page 64 | **Lamp block** page 65 | **Lamp block** page 67 | **Lamp block** page 70 | **Lamp block** page 71 | **Lamp block** page 74 | **Lamp block** page 76



**6 Emergency-stop pushbutton actuator, foolproof EN IEC 60947-5-5** page 21 | **Stop pushbutton actuator** page 22 | **Stop pushbutton actuator, flush mounting** page 37



**7 Switching element** page 51 | **Switching element for ring cable shoe** page 53 | **Switching element for Emergency-stop pushbutton** page 54



**8 Switching element** page 51 | **Switching element for ring cable shoe** page 53 | **Switching element for Emergency-stop pushbutton** page 54



**9 Lamp transformer** page 59



**10 Resistor block** page 59



**11 Resistor-diode block** page 59



**12 Flasher element** page 50



**13 Rotary selector switching element 30°** page 55



**14 Rotary selector switching element 30°** page 55



**15 Rotary selector switching element 30°** page 55



**16 Rotary selector switching element 30°** page 55



**17 Rotary selector switching element 45°** page 55



**18 Rotary selector switching element 45°** page 55



## 19 Rotary selector switching element 45° page 55



## 20 Rotary selector switching element 45° page 55



## 21 Rotary selector switching element 60° page 56



## 22 Rotary selector switching element 60° page 56



## 23 Rotary selector switching element 60° page 56



## 24 Rotary selector switching element 60° page 56



## 25 Rotary selector switching element 60° page 56



## 26 Rotary selector switching element 60° page 56



## 27 Rotary selector switching element 60° page 56



## 28 Rotary selector switching element 60° page 56





**29 Rotary selector switching element 60° page 56**



**30 Rotary selector switching element 60° page 56**



**31 Rotary selector switching element 60° page 56**



**32 Rotary selector switching element 60° page 56**



**33 Rotary selector switching element 60° page 56**



**34 Illuminated pushbutton actuator page 20 | Mushroom-head pushbutton actuator illuminated page 24 | Illuminated pushbutton actuator, flush mounting page 36**



**35 Selector switch actuator 3 positions, short lever page 29 | Selector switch actuator 3 positions, long lever page 30 | Selector switch actuator 3 positions, short lever, flush mounting page 42 | Selector switch actuator 3 positions, long lever, flush mounting page 43**



**36 Selector switch actuator 3 positions, short lever page 29 | Selector switch actuator 3 positions, long lever page 30 | Selector switch actuator 3 positions, short lever, flush mounting page 42 | Selector switch actuator 3 positions, long lever, flush mounting page 43**



**37 Selector switch actuator 2 positions, short lever page 27 | Selector switch actuator 2 positions, long lever page 28 | Selector switch actuator 2 positions, short lever, flush mounting page 40 | Selector switch actuator 2 positions, long lever, flush mounting page 41**



**38 Selector switch actuator 2 positions, short lever page 27 | Selector switch actuator 2 positions, short lever, 12 o'clock page 27 | Selector switch actuator 2 positions, long lever page 28 | Selector switch actuator 2 positions, long lever, 12 o'clock page 28 | Selector switch actuator 2 positions, short lever, flush mounting page 40 | Selector switch actuator 2 positions, short lever, 12 o'clock, flush mounting page 40 | Selector switch actuator 2 positions, long lever, flush mounting page 41 | Selector switch actuator 2 positions, long lever, 12 o'clock, flush mounting page 41**



**39 Selector switch actuator 3 positions, short lever** page 29 | **Selector switch actuator 3 positions, long lever** page 30 | **Selector switch actuator 3 positions, short lever, flush mounting** page 42 | **Selector switch actuator 3 positions, long lever, flush mounting** page 43



**40 Selector switch actuator 3 positions, short lever** page 29 | **Selector switch actuator 3 positions, long lever** page 30 | **Selector switch actuator 3 positions, short lever, flush mounting** page 42 | **Selector switch actuator 3 positions, long lever, flush mounting** page 43



**41 Illuminated pushbutton actuator** page 20 | **Mushroom-head pushbutton actuator illuminated** page 24 | **Illuminated pushbutton actuator, flush mounting** page 36



**42 Keylock switch actuator 3 positions** page 26 | **Keylock switch actuator 3 positions, flush mounting** page 39



**43 Keylock switch actuator 3 positions** page 26 | **Keylock switch actuator 3 positions, flush mounting** page 39



**44 Keylock switch actuator 2 positions** page 25 | **Keylock switch actuator 2 positions, flush mounting** page 38



**45 Keylock switch actuator 2 positions** page 25 | **Keylock switch actuator 2 positions, flush mounting** page 38



**46 Keylock switch actuator 3 positions** page 26 | **Keylock switch actuator 3 positions, flush mounting** page 39



**47 Keylock switch actuator 3 positions** page 26 | **Keylock switch actuator 3 positions, flush mounting** page 39



**48 Switching element** page 51 | **Switching element for ring cable shoe** page 53 | **Switching element for Emergency-stop pushbutton** page 54



**49 Switching element** page 51 | **Switching element for ring cable shoe** page 53 | **Switching element for Emergency-stop pushbutton** page 54



50 Switching element page 51 | Switching element for ring cable shoe page 53 | Switching element for Emergency-stop pushbutton page 54



51 Indicator full-face illumination compact page 12



# Index from Typ-Nr.

Typ-Nr.	Page	Typ-Nr.	Page	Typ-Nr.	Page
02-912.1	59	704.000.7	13	704.009.2	18
02-912.2	59	704.000.7	15	704.009.4	18
02-912.3	59	704.001.2	13	704.009.5	18
02-912.4	59	704.001.2	15	704.009.6	18
10-1406.1369	57	704.001.4	13	704.009.7	18
10-1409.1329	57	704.001.4	15	704.010.0	18
10-1412.1279	57	704.001.5	13	704.010.2	18
10-1416.1289	57	704.001.5	15	704.010.4	18
10-1419.1249	57	704.001.6	13	704.010.5	18
10-1420.1219	57	704.001.6	15	704.010.6	18
10-1422.1179	57	704.001.7	13	704.010.7	18
10-1424.1179	57	704.001.7	15	704.011.0	19
10-2506.1082	58	704.002.2	14	704.011.018	35
10-2506.1084	58	704.002.2	16	704.011.2	19
10-2506.1085	58	704.002.4	14	704.011.218	35
10-2506.1086	58	704.002.4	16	704.011.4	19
10-2506.1089	58	704.002.5	14	704.011.418	35
10-2509.1142	58	704.002.5	16	704.011.5	19
10-2509.1144	58	704.002.6	14	704.011.518	35
10-2509.1145	58	704.002.6	16	704.011.6	19
10-2509.1146	58	704.002.7	14	704.011.618	35
10-2509.1149	58	704.002.7	16	704.011.8	19
10-2512.1142	58	704.003.2	14	704.011.818	35
10-2512.1144	58	704.003.2	16	704.012.0	19
10-2512.1145	58	704.003.4	14	704.012.018	35
10-2512.1146	58	704.003.4	16	704.012.2	19
10-2512.1149	58	704.003.5	14	704.012.218	35
10-2513.1142	58	704.003.5	16	704.012.4	19
10-2513.1144	58	704.003.6	14	704.012.418	35
10-2513.1145	58	704.003.6	16	704.012.5	19
10-2513.1146	58	704.003.7	14	704.012.518	35
10-2513.1149	58	704.003.7	16	704.012.6	19
10-2519.1052	58	704.006.2	14	704.012.618	35
10-2519.1054	58	704.006.2	16	704.012.7	19
10-2519.1055	58	704.006.218	32	704.012.718	35
10-2519.1056	58	704.006.218	33	704.013.0	19
10-2519.1059	58	704.006.4	14	704.013.2	19
10-2H24.2052	58	704.006.4	16	704.013.4	19
10-2H24.2054	58	704.006.418	32	704.013.5	19
10-2H24.2055	58	704.006.418	33	704.013.6	19
10-2H24.2056	58	704.006.5	14	704.013.7	19
10-2H24.2059	58	704.006.5	16	704.020.2	12
10-2H25.2042	58	704.006.518	32	704.020.4	12
10-2H25.2044	58	704.006.518	33	704.020.5	12
10-2H25.2045	58	704.006.6	14	704.020.6	12
10-2H25.2046	58	704.006.6	16	704.020.7	12
10-2H25.2049	58	704.006.618	32	704.021.2	12
14-810.002	17	704.006.618	33	704.021.4	12
14-810.902	17	704.006.7	14	704.021.5	12
14-810.910	33	704.006.7	16	704.021.6	12
14-810.918	33	704.006.718	32	704.021.7	12
61-9481.6	61	704.006.718	33	704.022.2	12
61-9481.6	63	704.007.2	14	704.022.4	12
700.005.0	62	704.007.2	16	704.022.5	12
700.006.0	62	704.007.4	14	704.022.6	12
704.000.2	13	704.007.4	16	704.022.7	12
704.000.2	15	704.007.5	14	704.024.2	12
704.000.4	13	704.007.5	16	704.024.4	12
704.000.4	15	704.007.6	14	704.024.5	12
704.000.5	13	704.007.6	16	704.024.6	12
704.000.5	15	704.007.7	14	704.024.7	12
704.000.6	13	704.007.7	16	704.029.2	20
704.000.6	15	704.009.0	18	704.029.4	20

# Index from Typ-Nr.

Typ-Nr.	Page	Typ-Nr.	Page	Typ-Nr.	Page
704.029.5	20	704.043.6	19	704.084.6	24
704.029.6	20	704.043.7	19	704.084.7	24
704.029.7	20	704.059.2	20	704.086.2	24
704.030.2	20	704.059.4	20	704.086.4	24
704.030.4	20	704.059.5	20	704.086.5	24
704.030.5	20	704.059.6	20	704.086.6	24
704.030.6	20	704.059.7	20	704.086.7	24
704.030.7	20	704.060.2	20	704.092.0	30
704.032.2	20	704.060.4	20	704.093.0	30
704.032.218	36	704.060.5	20	704.093.010	43
704.032.4	20	704.060.6	20	704.093.018	43
704.032.418	36	704.060.7	20	704.093.0x28	46
704.032.5	20	704.062.2	20	704.094.0	30
704.032.518	36	704.062.218	36	704.095.0	30
704.032.6	20	704.062.4	20	704.095.010	43
704.032.618	36	704.062.418	36	704.095.018	43
704.032.7	20	704.062.5	20	704.095.0T28	46
704.032.718	36	704.062.518	36	704.095.0x28	46
704.033.2	20	704.062.6	20	704.096.0	30
704.033.4	20	704.062.618	36	704.097.0	30
704.033.5	20	704.062.7	20	704.097.010	43
704.033.6	20	704.062.718	36	704.097.018	43
704.033.7	20	704.063.2	20	704.097.0x28	46
704.039.0	18	704.063.4	20	704.098.0	30
704.039.2	18	704.063.5	20	704.099.0	30
704.039.4	18	704.063.6	20	704.099.010	43
704.039.5	18	704.063.7	20	704.099.018	43
704.039.6	18	704.064.2	21	704.099.0x28	46
704.039.7	18	704.066.2	21	704.100.0	28
704.040.0	18	704.070.0	23	704.100.0.12	28
704.040.2	18	704.070.2	23	704.101.0	28
704.040.4	18	704.070.4	23	704.101.0.12	28
704.040.5	18	704.070.5	23	704.101.010	41
704.040.6	18	704.071.0	23	704.101.010.12	41
704.040.7	18	704.071.2	23	704.101.018	41
704.041.0	18	704.071.210	37	704.101.018.12	41
704.041.018	34	704.071.218	37	704.101.018KN	44
704.041.2	18	704.071.4	23	704.101.0D.12	28
704.041.218	34	704.071.410	37	704.101.0KN	31
704.041.4	18	704.071.418	37	704.101.0x28	45
704.041.418	34	704.071.5	23	704.101.110KN	44
704.041.5	18	704.072.0	23	704.101.118KN	44
704.041.518	34	704.072.2	23	704.101.1KN	31
704.041.6	18	704.072.4	23	704.102.0	28
704.041.618	34	704.072.5	23	704.103.0	28
704.041.8	18	704.073.0	23	704.103.018	41
704.041.818	34	704.073.2	23	704.103.0x28	45
704.042.0	18	704.073.210	37	704.113.0	26
704.042.018	34	704.073.4	23	704.113.018	39
704.042.2	18	704.073.5	23	704.114.0	26
704.042.218	34	704.074.2	22	704.114.018	39
704.042.4	18	704.074.210	37	704.115.0	26
704.042.418	34	704.074.3	22	704.115.018	39
704.042.5	18	704.075.2	22	704.116.0	26
704.042.518	34	704.075.218	37	704.116.018	39
704.042.6	18	704.075.3	22	704.117.0	26
704.042.618	34	704.075.310	37	704.117.018	39
704.042.7	18	704.075.318	37	704.118.0	26
704.042.718	34	704.076.0	22	704.118.018	39
704.043.0	19	704.078.0	22	704.120.0	25
704.043.2	19	704.084.2	24	704.120.018	38
704.043.4	19	704.084.4	24	704.121.0	25
704.043.5	19	704.084.5	24	704.121.018	38

# Index from Typ-Nr.

Typ-Nr.	Page	Typ-Nr.	Page	Typ-Nr.	Page
704.122.0	25	704.206.2	14	704.229.700	36
704.122.018	38	704.206.2	16	704.230.2	20
704.123.0	25	704.206.200	32	704.230.208	36
704.123.018	38	704.206.200	33	704.230.4	20
704.123.018KN	45	704.206.4	14	704.230.408	36
704.123.118KN	45	704.206.4	16	704.230.5	20
704.124.0	26	704.206.400	32	704.230.508	36
704.124.018	39	704.206.400	33	704.230.6	20
704.151.XXX	47	704.206.5	14	704.230.608	36
704.152.XXX	47	704.206.5	16	704.230.7	20
704.153.XXX	47	704.206.500	32	704.230.708	36
704.154.XXX	47	704.206.500	33	704.239.0	18
704.155.XXX	47	704.206.6	14	704.239.000	34
704.199.2	13	704.206.6	16	704.239.2	18
704.199.2	15	704.206.600	32	704.239.200	34
704.199.4	13	704.206.600	33	704.239.4	18
704.199.4	15	704.206.7	14	704.239.400	34
704.199.5	13	704.206.7	16	704.239.5	18
704.199.5	15	704.206.700	32	704.239.500	34
704.199.6	13	704.206.700	33	704.239.6	18
704.199.6	15	704.207.2	14	704.239.600	34
704.199.7	13	704.207.2	16	704.239.7	18
704.199.7	15	704.207.4	14	704.239.700	34
704.200.2	13	704.207.4	16	704.240.0	18
704.200.2	15	704.207.5	14	704.240.008	34
704.200.4	13	704.207.5	16	704.240.2	18
704.200.4	15	704.207.6	14	704.240.208	34
704.200.5	13	704.207.6	16	704.240.4	18
704.200.5	15	704.207.7	14	704.240.408	34
704.200.6	13	704.207.7	16	704.240.5	18
704.200.6	15	704.209.0	18	704.240.508	34
704.200.7	13	704.209.000	34	704.240.6	18
704.200.7	15	704.209.2	18	704.240.608	34
704.202.2	14	704.209.200	34	704.240.7	18
704.202.2	16	704.209.4	18	704.240.708	34
704.202.208	32	704.209.400	34	704.259.2	20
704.202.208	33	704.209.5	18	704.259.200	36
704.202.4	14	704.209.500	34	704.259.4	20
704.202.4	16	704.209.6	18	704.259.400	36
704.202.408	32	704.209.600	34	704.259.5	20
704.202.408	33	704.209.7	18	704.259.500	36
704.202.5	14	704.209.700	34	704.259.6	20
704.202.5	16	704.210.0	18	704.259.600	36
704.202.508	32	704.210.008	34	704.259.7	20
704.202.508	33	704.210.2	18	704.259.700	36
704.202.6	14	704.210.208	34	704.260.2	20
704.202.6	16	704.210.4	18	704.260.208	36
704.202.608	32	704.210.408	34	704.260.4	20
704.202.608	33	704.210.5	18	704.260.408	36
704.202.7	14	704.210.508	34	704.260.5	20
704.202.7	16	704.210.6	18	704.260.508	36
704.202.708	32	704.210.608	34	704.260.6	20
704.202.708	33	704.210.7	18	704.260.608	36
704.203.2	14	704.210.708	34	704.260.7	20
704.203.2	16	704.229.2	20	704.260.708	36
704.203.4	14	704.229.200	36	704.292.0	30
704.203.4	16	704.229.4	20	704.292.000	43
704.203.5	14	704.229.400	36	704.292.008	43
704.203.5	16	704.229.5	20	704.294.0	30
704.203.6	14	704.229.500	36	704.294.000	43
704.203.6	16	704.229.6	20	704.294.008	43
704.203.7	14	704.229.600	36	704.296.0	30
704.203.7	16	704.229.7	20	704.296.000	43

# Index from Typ-Nr.

Typ-Nr.	Page	Typ-Nr.	Page	Typ-Nr.	Page
704.296.008	43	704.409.010	42	704.601.2	72
704.298.0	30	704.409.018	42	704.601.21	73
704.298.000	43	704.410.0	27	704.601.4	72
704.298.008	43	704.410.0.12	27	704.601.41	73
704.300.0	28	704.411.0	27	704.601.5	72
704.300.0.12	28	704.411.0.12	27	704.601.51	73
704.300.000	41	704.411.010	40	704.601.6	72
704.300.000.12	41	704.411.010.12	40	704.601.61	73
704.300.008	41	704.411.010KN	44	704.601.8	72
704.300.008.12	41	704.411.018	40	704.601.81	73
704.300.100KN	44	704.411.018.12	40	704.601.9	72
704.300.108KN	44	704.411.0B.12	27	704.601.91	73
704.300.1KN	31	704.411.110KN	44	704.602.0	67
704.302.0	28	704.411.118KN	44	704.602.0	72
704.302.000	41	704.411.1KN	31	704.602.2	67
704.302.008	41	704.412.0	27	704.602.2	72
704.333.0	26	704.413.0	27	704.602.4	67
704.333.000	39	704.413.010	40	704.602.4	72
704.333.008	39	704.413.018	40	704.602.5	67
704.334.0	26	704.502.0	29	704.602.5	72
704.334.000	39	704.502.000	42	704.602.6	67
704.334.008	39	704.502.008	42	704.602.6	72
704.335.0	26	704.504.0	29	704.602.7	67
704.335.000	39	704.504.000	42	704.602.7	72
704.335.008	39	704.504.008	42	704.602.7A01	67
704.336.0	26	704.506.0	29	704.602.7A01	72
704.336.000	39	704.506.000	42	704.603.2	64
704.336.008	39	704.506.008	42	704.603.2	65
704.337.0	26	704.508.0	29	704.603.4	64
704.337.000	39	704.508.000	42	704.603.4	65
704.337.008	39	704.508.008	42	704.603.5	64
704.338.0	26	704.510.0	27	704.603.5	65
704.338.000	39	704.510.0.12	27	704.603.6	64
704.338.008	39	704.510.000	40	704.603.6	65
704.340.0	25	704.510.000.12	40	704.603.7	64
704.340.000	38	704.510.008	40	704.603.7	65
704.340.008	38	704.510.008.12	40	704.608.7	64
704.341.0	25	704.510.100KN	44	704.608.7	65
704.341.000	38	704.510.108KN	44	704.608.9	64
704.341.008	38	704.510.1KN	31	704.608.9	65
704.342.0	25	704.512.0	27	704.609.0	67
704.342.000	38	704.512.000	40	704.609.0	72
704.342.008	38	704.512.008	40	704.609.7	67
704.343.0	25	704.600.0	69	704.609.7	72
704.343.000	38	704.600.0	73	704.609.9	67
704.343.008	38	704.600.1	69	704.609.9	72
704.344.0	26	704.600.1	73	704.609.9A01	67
704.344.000	39	704.600.1A	69	704.609.9A01	72
704.344.008	39	704.600.1A	73	704.610.7	68
704.402.0	29	704.600.2	69	704.610.9	68
704.403.0	29	704.600.2	74	704.611.2	68
704.403.010	42	704.600.3	69	704.611.4	68
704.403.018	42	704.600.3	74	704.611.5	68
704.404.0	29	704.600.5/A	69	704.611.7	68
704.405.0	29	704.600.5/A	74	704.630.1	64
704.405.010	42	704.600.6	69	704.631.1	72
704.405.018	42	704.600.6	73	704.632.1	72
704.406.0	29	704.600.7	69	704.633.1	67
704.407.0	29	704.600.7	73	704.642.0	64
704.407.010	42	704.600.9	69	704.642.1	64
704.407.018	42	704.600.9	73	704.642.2	64
704.408.0	29	704.601.0	72	704.701.0	71
704.409.0	29	704.601.01	73	704.701.0	76

# Index from Typ-Nr.

Typ-Nr.	Page	Typ-Nr.	Page	Typ-Nr.	Page
704.701.4	71	704.8A254	55	704.910.4	54
704.701.4	76	704.8A255	55	704.910.4B	53
704.701.6	71	704.8A270	56	704.910.5	51
704.701.6	76	704.8A271	56	704.910.5	54
704.702.0	75	704.8A272	56	704.910.5B	53
704.702.2	70	704.8A639	55	704.911.1	51
704.702.2	70	704.8A730	56	704.911.1	54
704.702.2	75	704.8A731	56	704.911.1B	53
704.702.4	70	704.900.1	52	704.911.2	51
704.702.4	70	704.900.1B	53	704.911.2	54
704.702.4	75	704.900.2	52	704.911.2B	53
704.702.5	70	704.900.2B	53	704.911.3	51
704.702.5	70	704.900.3	52	704.911.3	54
704.702.5	75	704.900.3B	53	704.911.3B	53
704.702.6	70	704.900.4	52	704.911.4	51
704.702.6	70	704.900.4B	53	704.911.4	54
704.702.6	75	704.900.5	52	704.911.4B	53
704.702.7	70	704.900.5B	53	704.911.5	51
704.702.7	70	704.901.1	52	704.911.5	54
704.702.7	75	704.901.1/D	52	704.911.5B	53
704.702.9	75	704.901.2	52	704.912.1	51
704.703.2	66	704.901.2/D	52	704.912.1	54
704.703.4	66	704.901.3	52	704.912.2	51
704.703.5	66	704.901.3/D	52	704.912.2	54
704.703.6	66	704.901.4	52	704.912.3	51
704.703.7	66	704.901.4/D	52	704.912.3	54
704.706.7	66	704.901.5	52	704.912.4	51
704.707.7	71	704.901.5/D	52	704.912.4	54
704.707.7	75	704.902.1	52	704.912.5	51
704.708.7	66	704.902.2	52	704.912.5	54
704.708.9	66	704.902.3	52	704.915.1	51
704.709.7	70	704.902.4	52	704.915.1	54
704.709.7	75	704.902.5	52	704.915.1/D	51
704.709.9	70	704.905.1	52	704.915.1/D	54
704.709.9	75	704.905.1/D	52	704.915.2	51
704.730.0	66	704.905.2	52	704.915.2	54
704.730.1	66	704.905.2/D	52	704.915.2/D	51
704.731.0	75	704.905.3	52	704.915.2/D	54
704.731.1	75	704.905.3/D	52	704.915.3	51
704.732.0	75	704.905.4	52	704.915.3	54
704.732.1	75	704.905.4/D	52	704.915.3/D	51
704.733.0	70	704.905.5	52	704.915.3/D	54
704.733.1	70	704.905.5/D	52	704.915.4	51
704.741.0	75	704.907.1	51	704.915.4	54
704.741.8	75	704.907.2	51	704.915.4/D	51
704.742.0	75	704.907.3	51	704.915.4/D	54
704.742.8	75	704.907.4	51	704.915.5	51
704.743.0	70	704.907.5	51	704.915.5	54
704.743.8	70	704.908.1	51	704.915.5/D	51
704.8A230	56	704.908.2	51	704.915.5/D	54
704.8A231	56	704.908.3	51	704.917.1	54
704.8A232	56	704.908.4	51	704.917.2	54
704.8A233	56	704.908.5	51	704.917.3	54
704.8A234	55	704.910.1	51	704.917.4	54
704.8A235	55	704.910.1	54	704.917.5	54
704.8A236	55	704.910.1B	53	704.918.1	54
704.8A237	55	704.910.2	51	704.918.2	54
704.8A238	55	704.910.2	54	704.918.3	54
704.8A239	55	704.910.2B	53	704.918.4	54
704.8A250	56	704.910.3	51	704.918.5	54
704.8A251	56	704.910.3	54	704.925.0	48
704.8A252	56	704.910.3B	53	704.925.2	48
704.8A253	56	704.910.4	51	704.925.3	48



# Index from Typ-Nr.

Typ-Nr.	Page	Typ-Nr.	Page	Typ-Nr.	Page
704.925.7	49	704.950.5	65	704.970.5	59
704.927.8	60	704.950.5	66	704.970.6	59
704.927.9	60	704.950.5	69	704.989.251	49
704.928.18	49	704.950.5	71	704.990.0	62
704.928.28	49	704.950.5	74	98-968	62
704.928.38	49	704.950.5	76		
704.940.8	61	704.953.0	69		
704.940.9	62	704.953.0	74		
704.941.0	59	704.954.0	61		
704.941.1	62	704.955.0	68		
704.941.5	59	704.955.0	73		
704.941.9	59	704.955.1	68		
704.942.5	58	704.955.1	73		
704.943.0	50	704.955.3	68		
704.943.1	50	704.955.3	73		
704.943.2	50	704.955.4	68		
704.943.5	50	704.955.4	73		
704.945.0	60	704.955.9	68		
704.945.1	63	704.955.9	73		
704.945.2	63	704.955.9E	68		
704.945.3	63	704.955.9E	73		
704.945.4	63	704.960.0	61		
704.945.5	63	704.960.4	49		
704.945.6	61	704.960.5	65		
704.945.6	63	704.960.5	66		
704.945.7	60	704.960.5	69		
704.945.8	60	704.960.5	71		
704.950.0	65	704.960.5	74		
704.950.0	67	704.960.5	76		
704.950.0	70	704.960.8	61		
704.950.0	71	704.960.9	62		
704.950.0	74	704.963.0	60		
704.950.0	76	704.963.1	60		
704.950.0B	65	704.963.2	60		
704.950.0B	67	704.963.3	60		
704.950.0B	70	704.963.5	60		
704.950.0B	71	704.963.6	60		
704.950.0B	74	704.963.7	60		
704.950.0B	76	704.963.8	60		
704.950.1	65	704.964.5	56		
704.950.1	67	704.964.7	49		
704.950.1	70	704.964.8	49		
704.950.1	71	704.964.9	49		
704.950.1	74	704.965.1	56		
704.950.1	76	704.965.2	56		
704.950.1/D	65	704.965.3	56		
704.950.1/D	67	704.965.4	56		
704.950.1/D	70	704.965.5	56		
704.950.1/D	71	704.965.6	56		
704.950.1/D	74	704.965.7	56		
704.950.1/D	76	704.965.8	56		
704.950.2/D	65	704.965.9	56		
704.950.2/D	67	704.966.0	56		
704.950.2/D	70	704.966.1	56		
704.950.2/D	71	704.966.2	56		
704.950.2/D	74	704.968.0	48		
704.950.2/D	76	704.968.1	48		
704.950.3	65	704.968.2	48		
704.950.3	67	704.968.3	48		
704.950.3	70	704.968.4	48		
704.950.3	71	704.968.5	48		
704.950.3	74	704.970.3	59		
704.950.3	76	704.970.4	59		

	<b>EAO AG</b>
	Tannwaldstrasse 88 4601 Olten, Switzerland
<b>E-mail</b>	info@eao.com
<b>Website</b>	www.eao.com
	<b>Austria</b>
Phone	+49 201 85 87 0
Fax	+49 201 85 87 210
E-mail	sales.ede@eao.com
	<b>Belgium</b>
Phone	+32 3 777 82 36
Fax	+32 3 777 84 19
E-mail	sales.ebl@eao.com
	<b>China</b>
Phone	+852 27 86 91 41
Fax	+852 27 86 95 61
E-mail	sales.ehk@eao.com
	<b>France</b>
Phone	+33 1 64 43 37 37
Fax	+33 1 64 43 37 49
E-mail	sales.esa@eao.com
	<b>Germany</b>
Phone	+49 201 85 87 0
Fax	+49 201 85 87 210
E-mail	sales.ede@eao.com
	<b>Italy</b>
Phone	+39 035 481 0189
Fax	+39 035 481 3786
E-mail	sales.eit@eao.com
	<b>Japan</b>
Phone	+81 3 5444 5411
Fax	+81 3 5444 0345
E-mail	sales.esj@eao.com
	<b>Netherlands</b>
Phone	+31 78 653 17 00
Fax	+31 78 653 17 99
E-mail	sales.enl@eao.com
	<b>Sweden</b>
Phone	+46 8 683 86 60
Fax	+46 8 724 29 12
E-mail	sales.esw@eao.com
	<b>Switzerland</b>
Phone	+41 62 388 95 00
Fax	+41 62 388 95 55
E-mail	sales.ech@eao.com
	<b>United Kingdom</b>
Phone	+44 1444 236 000
Fax	+44 1444 236 641
E-mail	sales.euk@eao.com
	<b>USA</b>
Phone	+1 203 877 4577
Fax	+1 203 877 3694
E-mail	sales.eus@eao.com
	<b>Other Countries</b>
Phone	+41 62 286 92 10
Fax	+41 62 296 21 62
E-mail	info@eao.com

Компания «Океан Электроники» предлагает заключение долгосрочных отношений при поставках импортных электронных компонентов на взаимовыгодных условиях!

Наши преимущества:

- Поставка оригинальных импортных электронных компонентов напрямую с производств Америки, Европы и Азии, а так же с крупнейших складов мира;
- Широкая линейка поставок активных и пассивных импортных электронных компонентов (более 30 млн. наименований);
- Поставка сложных, дефицитных, либо снятых с производства позиций;
- Оперативные сроки поставки под заказ (от 5 рабочих дней);
- Экспресс доставка в любую точку России;
- Помощь Конструкторского Отдела и консультации квалифицированных инженеров;
- Техническая поддержка проекта, помощь в подборе аналогов, поставка прототипов;
- Поставка электронных компонентов под контролем ВП;
- Система менеджмента качества сертифицирована по Международному стандарту ISO 9001;
- При необходимости вся продукция военного и аэрокосмического назначения проходит испытания и сертификацию в лаборатории (по согласованию с заказчиком);
- Поставка специализированных компонентов военного и аэрокосмического уровня качества (Xilinx, Altera, Analog Devices, Intersil, Interpoint, Microsemi, Actel, Aeroflex, Peregrine, VPT, Syfer, Eurofarad, Texas Instruments, MS Kennedy, Miteq, Cobham, E2V, MA-COM, Hittite, Mini-Circuits, General Dynamics и др.);

Компания «Океан Электроники» является официальным дистрибьютором и эксклюзивным представителем в России одного из крупнейших производителей разъемов военного и аэрокосмического назначения «JONHON», а так же официальным дистрибьютором и эксклюзивным представителем в России производителя высокотехнологичных и надежных решений для передачи СВЧ сигналов «FORSTAR».



## JONHON

«JONHON» (основан в 1970 г.)

Разъемы специального, военного и аэрокосмического назначения:

(Применяются в военной, авиационной, аэрокосмической, морской, железнодорожной, горно- и нефтедобывающей отраслях промышленности)

«FORSTAR» (основан в 1998 г.)

ВЧ соединители, коаксиальные кабели, кабельные сборки и микроволновые компоненты:

(Применяются в телекоммуникациях гражданского и специального назначения, в средствах связи, РЛС, а так же военной, авиационной и аэрокосмической отраслях промышленности).



Телефон: 8 (812) 309-75-97 (многоканальный)

Факс: 8 (812) 320-03-32

Электронная почта: [ocean@oceanchips.ru](mailto:ocean@oceanchips.ru)

Web: <http://oceanchips.ru/>

Адрес: 198099, г. Санкт-Петербург, ул. Калинина, д. 2, корп. 4, лит. А