



DEUTSCH

BRANCHE CONNECTEURS AEROMILITAIRES



Single Module EN 4165

Arinc 809 - BACC65 - EN4165

The DMC-M is a modular rectangular connector which was designed and developed by Deutsch in the 1980's. It has since set the modular connector standard in the Aerospace & Military industries, and is now standardised by European Specification EN4165.

■ The modularity

The DMC-M is designed to address a wide range of requirements due to its wide range of contacts arrangements : from contacts size 22 to size 8, but also coaxial, quadax or optical contacts. Each mated half of the DMC-M connector can contain both male and female configurations which allow you to mix input and output with signal and power supply. You can easily modify your system by simply removing modules from the shells and replace them with a new layout. This makes the DMC-M perfect for both new designs and retrofit applications.

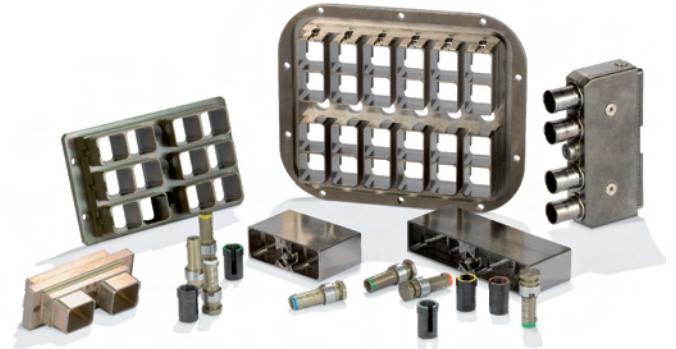

■ The safety

The DMC-M provides a large number of insert layout possibilities. It allows different keying possibilities between plugs and receptacles. DMC-M provides a real EMI protection following most stringent Aerospace and Military specifications.

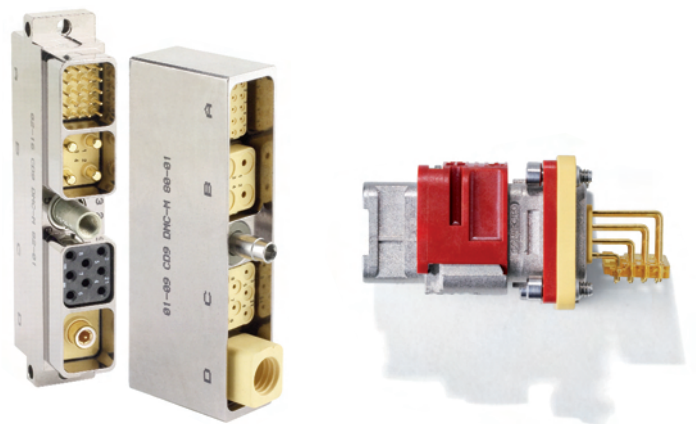

■ The reliability

To increase the level of reliability of the cabin interconnections, the Single Module DMC-M is compliant with the most demanding avionic specifications, in terms of sealing, vibrations or mechanical endurance in accordance with EN 4165.

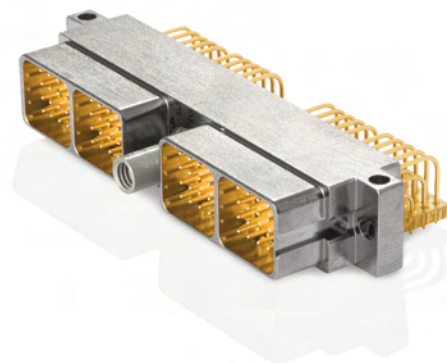

■ The weight optimization

Weight saving is commonly a high concern, the Single Module DMC-M has been designed in composite with a metallized plating for weight and mass saving.





ARINC809 - BACC65 - EN4165

The New Standard Connector for Aircraft equipment and cabin systems.

Advantages

Light weight composite, modularity, color and mechanical coded, push pull coupling are the key features of this connector

Standard

ARINC809, BACC65, EN4165 qualified

Markets & Application

Cabin and avionic systems
Military - Railway

Technical characteristics

Housing : Composite
Plating : Nickel
Inserts : Thermoplastic and FSR
Vibrations : 20 g
Durability : 500 mating cycles
Salt spray : 500 hours
Contacts : Copper alloy with gold on nickel plating
Interfacial sealing : $1,1 \cdot 10^{-2}$ bar

Electrical characteristics

Temperature range : -55°C to $+175^{\circ}\text{C}$
Insulation resistance : $\geq 5000\text{ M}\Omega$
Maximum current : Size 22 : 5 A
Size 20 : 7,5 A
Size 16 : 13 A
Size 12 : 23 A
Size 8 : 46 A

EMI shielding performance

MHz frequency	100	200	300	400	800	1000
Attenuation (dB)	90	88	88	87	85	85

Weight

Extender Receptacle	Short Receptacle	Plug	Backshell
7 gr	6 gr	9 gr	4 - 7gr
0,015 lbs	0,013 lbs	0,020 lbs	0,009 - 0,015 lbs

Recommended mounting for receptacle screw torque

$0,5 \pm 0,1\text{ N.m}$ or $4,4 \pm 0,9\text{ In. Lbf}$
When using DEUSCH integrated. Nut plate Réf. 787-0016-00 (see page 6)

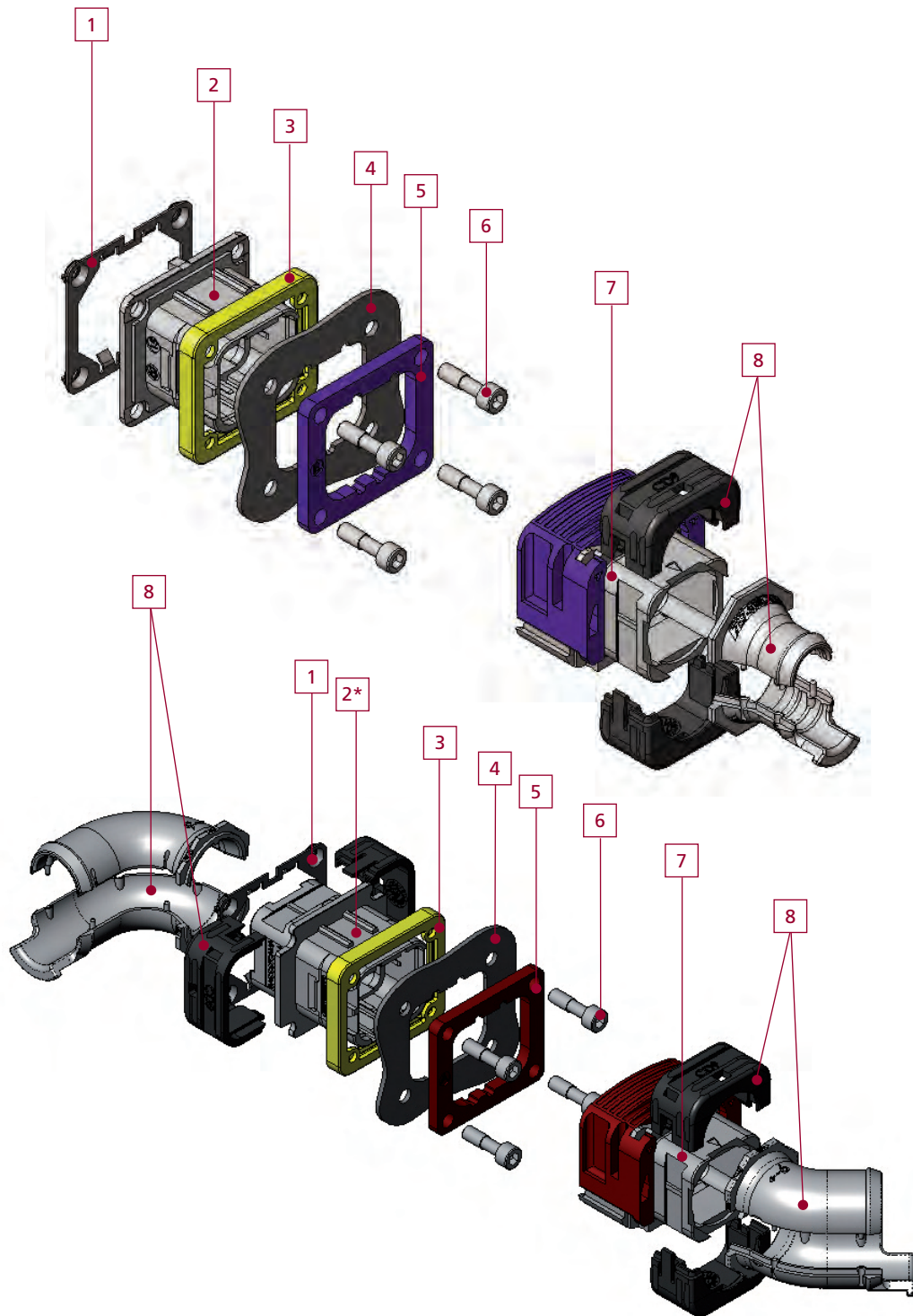

- | | |
|-------------------------------|----------------------------------|
| 1 - Nut plate (option). | 5 - Color coding plate (option). |
| 2 - Short receptacle. | 6 - Screws (ordered separately). |
| 2* - Extender receptacle. | 7 - Plug. |
| 3 - Sealing gasket (option). | 8 - Backshell. |
| 4 - Panel (up to 2 mm thick). | |

DEUTSCH designation system for the shells

Example of order

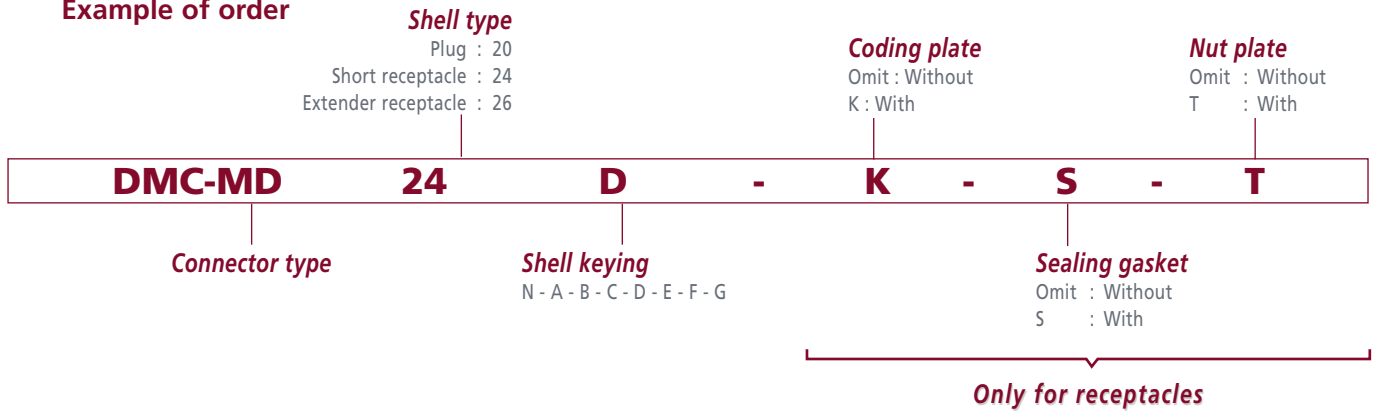

DEUTSCH designation system for the accessories

Example of order

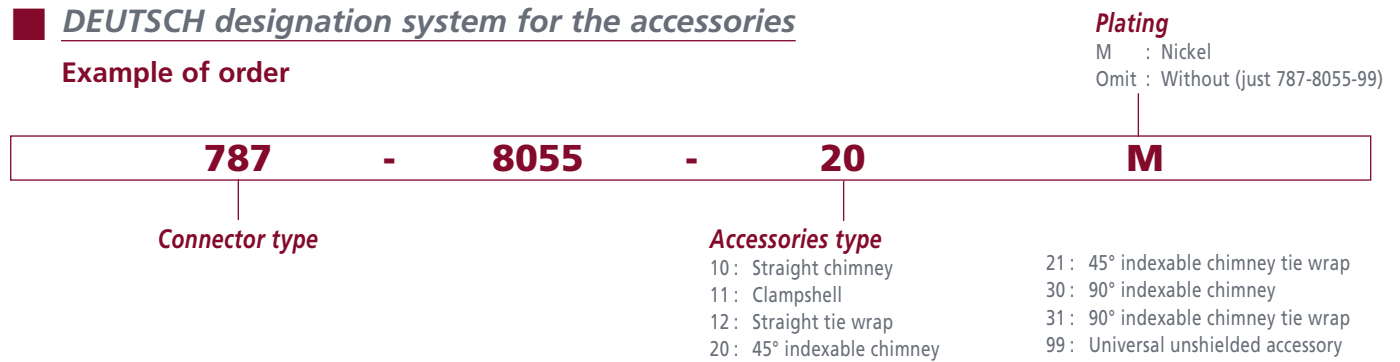

Standard designation system for the shells

Example of order

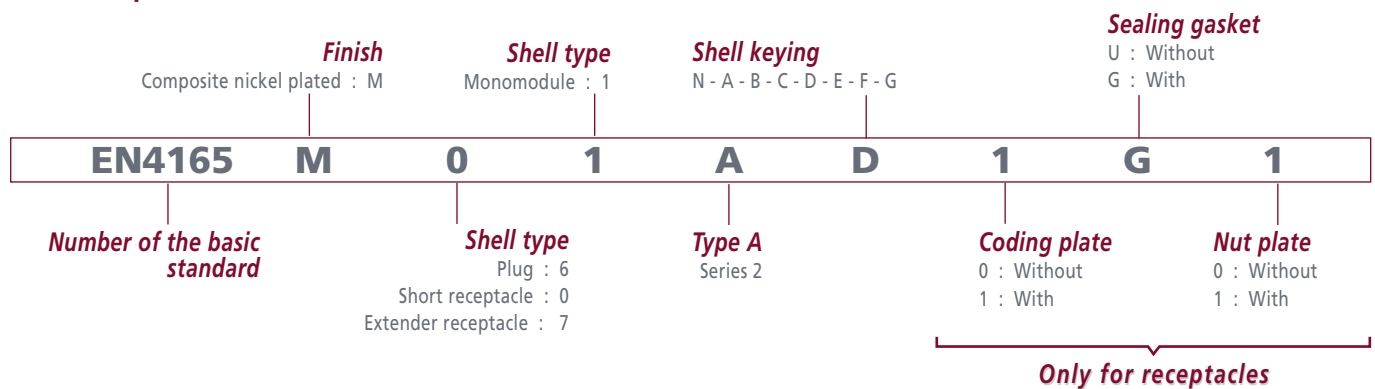

Standard designation system for the accessories

Example of order

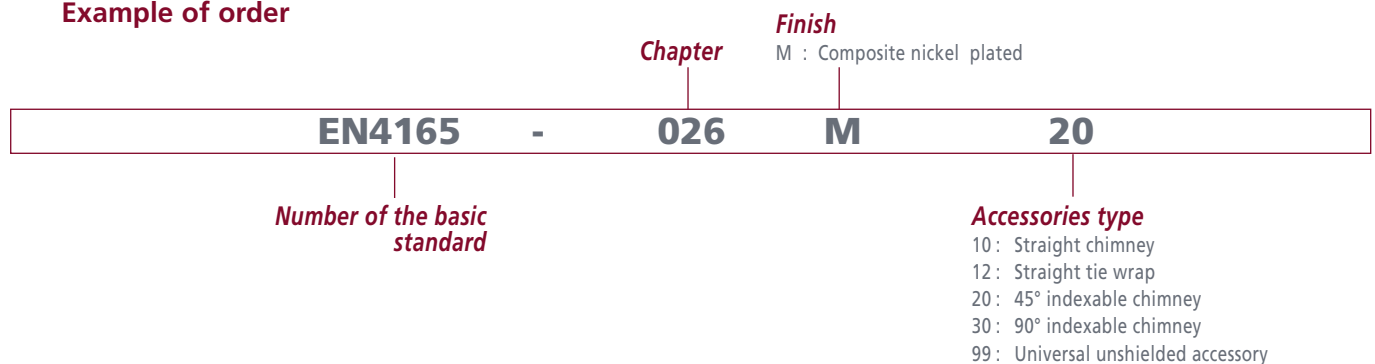

Backshells

STRAIGHT CHIMNEY
787-8055-10M
EN4165-026M10



STRAIGHT CLAMPSHELL
787-8055-11M



UNIVERSAL UNSHIELDED ACCESSORY
787-8055-99
EN4165-026-99



STRAIGHT CHIMNEY TIE WRAP
787-8055-12M
EN4165-026M12



45° INDEXABLE CHIMNEY
787-8055-20M
EN4165-026M20



45° INDEXABLE CHIMNEY TIE WRAP
787-8055-21M

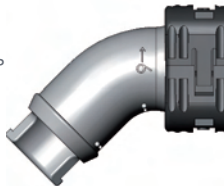

90° INDEXABLE CHIMNEY
787-8055-30M
EN4165-026M30



90° INDEXABLE CHIMNEY TIE WRAP
787-8055-31M



Plug

DMC-MD 20 N
BACC65BUMN
EN4165M61AN

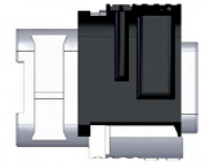

DMC-MD 20 A
BACC65BUMA
EN4165M61AA

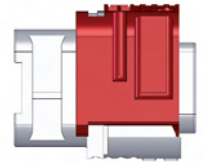

DMC-MD 20 B
BACC65BUMB
EN4165M61AB

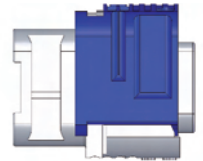

DMC-MD 20 C
BACC65BUMC
EN4165M61AC

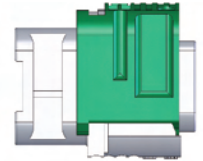

DMC-MD 20 D
BACC65BUMD
EN4165M61AD

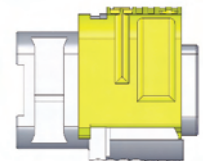

DMC-MD 20 E
EN4165M61AE

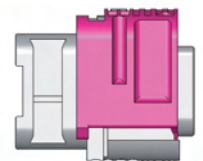

DMC-MD 20 F
EN4165M61AF

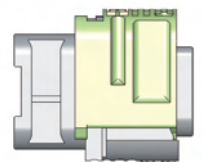

DMC-MD 20 G
EN4165M61AG

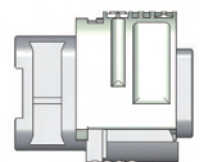

Note : EN4165 part numbers in progress to be released.

DEUTSCH Part numbers (DMC-M / 787)
BOEING Part numbers (BACC)
STANDARD Part numbers (EN4165)

Receptacles

Backshells

EXTENDER RECEPTACLE

DMC-MD 26 *X
BACC65CAM *X
EN4165M71A *X

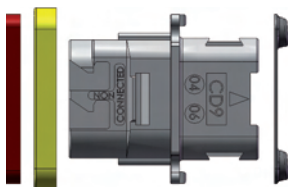

• : To be ordered separately
(no BACC65 references)

*X							
N	A	B	C	D	E	F	G

SHORT RECEPTACLE

DMC-MD 24 *X
BACC65BVM *X
EN4165M01A *X

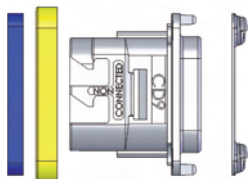

• : To be ordered separately
(no BACC65 references)

NO ACCESSORY CAN BE FIXED ON THIS RECEPTACLE



STRAIGHT CHIMNEY
787-8055-10M
EN4165-026M10



STRAIGHT CLAMPHELL
787-8055-11M



UNIVERSAL UNSHIELDED ACCESSORY
787-8055-99
EN4165-026-99



STRAIGHT CHIMNEY TIE WRAP
787-8055-12M
EN4165-026M12



45° INDEXABLE CHIMNEY
787-8055-20M
EN4165M20



45° INDEXABLE CHIMNEY TIE WRAP
787-8055-21M



90° INDEXABLE CHIMNEY
787-8055-30M
EN4165M30

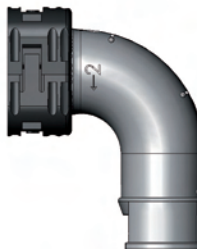

90° INDEXABLE CHIMNEY TIE WRAP
787-8055-31M

Note : EN4165 part numbers in progress to be released.

Optionnal parts for receptacle

• Locate mating parts

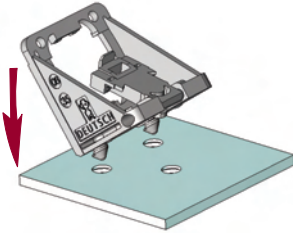

• Install rear dowels

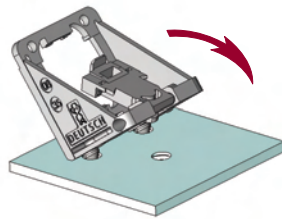

• Fix and snap in position

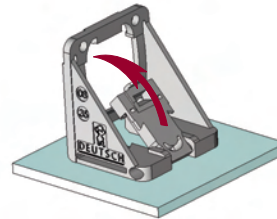

• Installed



• Align receptacle with bracket

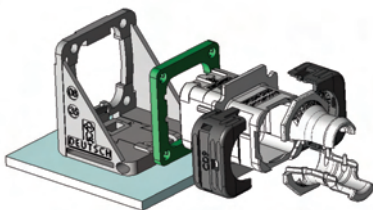

• Install and fix in position

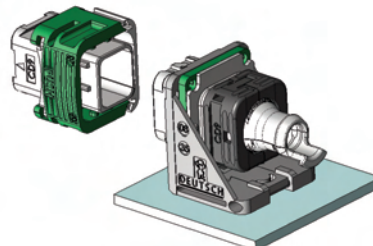

• Assembled



HIGH SPEED CHIMNEY
FOR PART NUMBERING,
PLEASE CONSULT US

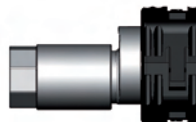

Note : These backshells have been developed specially for high speed wire management. Backshells have to be ordered with the DMC-M 99-02-XX inserts.

• Keying plate

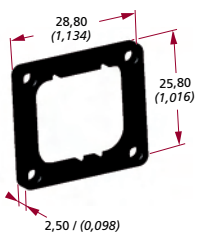

N : 787-0015-00	EN4165-25CN
A : 787-0015-01	EN4165-25CA
B : 787-0015-02	EN4165-25CB
C : 787-0015-03	EN4165-25CC
D : 787-0015-04	EN4165-25CD
E : 787-0015-05	EN4165-25CE
F : 787-0015-06	EN4165-25CF
G : 787-0015-07	EN4165-25CG

• Sealing gasket

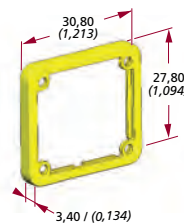

787-0011-00
EN4165-25E

• Nut plate

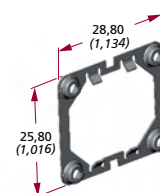

787-0016-00
EN4165-25D

• Panel mounting bracket

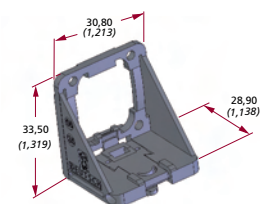

787-0014-00

Protective caps



SHIPPING AND
DUST PLUG CAP
104-0236-00



SHIPPING AND
DUST RECEPTACLE CAP
104-0235-00



RECEPTACLE AND EXTENDER EMC CAP
WITH LANYARD 787-8011-00
WITHOUT LANYARD 787-8009-00



PLUG
FLIGHT CAP
787-8010-00













RECEPTACLE AND EXTENDER FLIGHT CAP
WITH LANYARD 787-8017-00
WITHOUT LANYARD 787-8016-00



LANYARD
787-8013-00

Pin contacts as per MIL C 39029/58 and EN3155

Modules	Details	PART NUMBER CROSS
	20 contacts size 22	DMC-M 20-22 AN BAC110BC2022PNB EN4165 20-22 A1NA
	12 contacts size 20	DMC-M 12-20 AN BAC110BC1220PNB EN4165 12-20 A1NA
	8 contacts size 16	DMC-M 08-16 AN BAC110BC0816PNB EN4165 08-16 A1NA
	4 contacts size 12	DMC-M 04-12 AN EN4165 04-12 A1NA
	1 contact size 8	DMC-M 01-08 AN EN4165 01-08 A1NA
	6 contacts size 16 + 5 contacts size 22	DMC-M 99-01 AN BAC110BC1622PNB EN4165 99-01 A1NA
	20 contacts size 22	DMC-MA 20-22 AN EN4165 20A22 A1NA
	6 contacts size 16 + 5 contacts size 22	DMC-MA 99-01 AN EN4165 99A01A1NA
	3 contacts size 20 + 8 contacts size 22	DMC-M 99-02 AN *
	8 contacts size 20 + 2 contacts size 16	DMC-M 99-10 AN EN4165 09-10 A1NA
	Blanking module	DMC-M 00-00 AN EN4165 00-00 A1NA

Note : DMC-MA modules are compatible with Aluminium Cable contacts and with EN3155-70 / 71 size 22.

Distribution shunt modules use dedicated contacts based on standard M39029.

DMC-M 99-02 are specific modules for highspeed application.

Socket contacts as per MIL C 39029/57 and EN3155

Modules	Details	PART NUMBER CROSS
	20 contacts size 22	DMC-M 20-22 BN BAC110BC2022SNB EN4165 20-22 A1NB
	12 contacts size 20	DMC-M 12-20 BN BAC110BC1220SNB EN4165 12-20 A1NB
	8 contacts size 16	DMC-M 08-16 BN BAC110BC0816SNB EN4165 08-16 A1NB
	4 contacts size 12	DMC-M 04-12 BN EN4165 04-12 A1NB
	1 contact size 8	DMC-M 01-08 BN EN4165 01-08 A1NB
	6 contacts size 16 + 5 contacts size 22	DMC-M 99-01 BN BAC110BC1622SNB EN4165 99-01 A1NB
	20 contacts size 22	DMC-MA 20-22 BN EN4165 20A22A1NB
	6 contacts size 16 + 5 contacts size 22	DMC-MA 99-01 BN EN4165 99A01 A1NB
	3 contacts size 20 + 8 contacts size 22	DMC-M 99-02 BN *
	8 contacts size 20 + 2 contacts size 16	DMC-M 99-10 BN EN4165 09-10 A1NB
	3 x 4 + 4 x 2 Shunted contacts size 22	DMC-M 22-07 SN MBBN 3330 Y2A22S
	5 x 4 Shunted contacts size 22	DMC-M 22-05 SN MBBN 3330 Y2022S
	10 x 2 Shunted contacts size 22	DMC-M 22-10 SN MBBN 3330 Y2B22S

Aluminium cable technology

Distribution shunt modules

* To be ordered with high speed chimney (see page 6)

DEUTSCH Part numbers (DMC-M / 787)
BOEING Part numbers (BACC)
STANDARD Part numbers (EN4165)

Receptacles & Plug

Receptacle

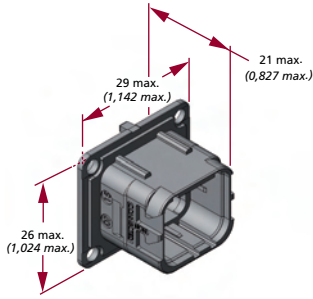

Extender receptacle

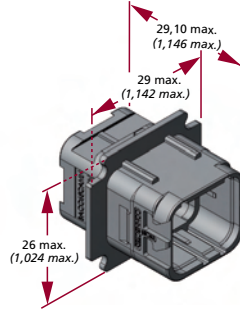

Plug

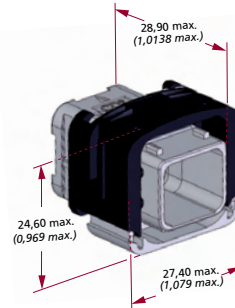

Backshell / chimney indexation



All backshells can be indexed in eight positions on the rear of plug and receptacle shell. This gives maximum flexibility during design and cable installation and reduces the number of variants and components.

Mounting panel details

Box mounting receptacle

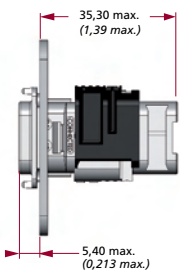

Extender receptacle

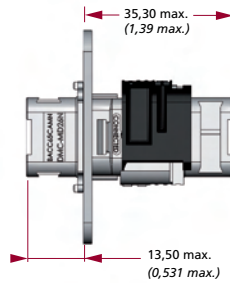

Straight chimney

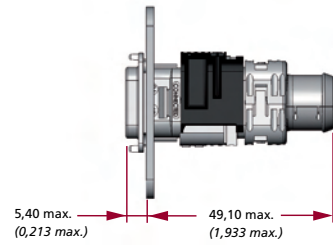

Straight clampshell

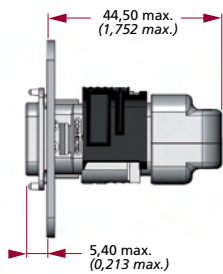

Straight chimney tie wrap

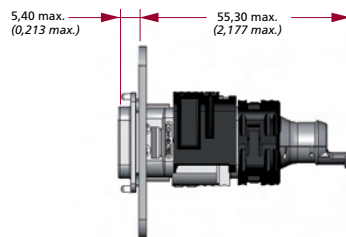

Universal unshielded accessory

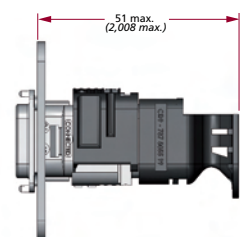

45° indexable chimney

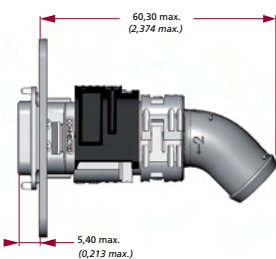

45° indexable chimney tie wrap

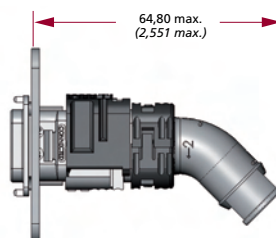

90° indexable chimney

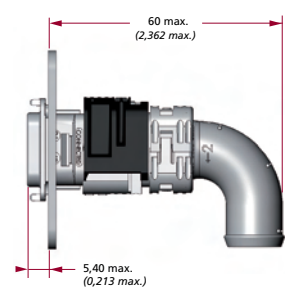

Panel mounting cutout details Single Module EN4165

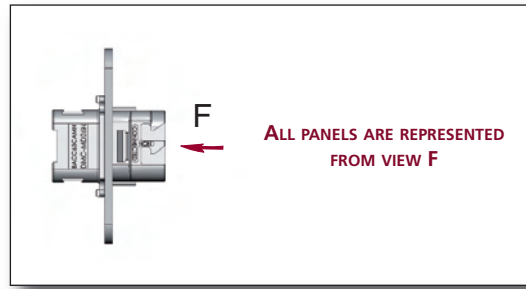

GENERIC DIMENSIONS

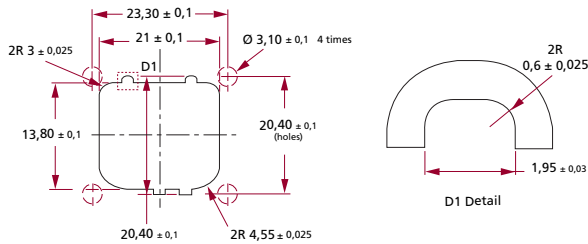

FREE

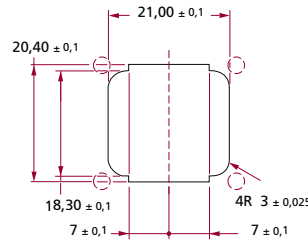

ORIENTATION

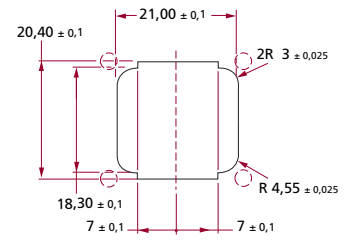

Note : Dimensions are in millimeters. Each hole $\varnothing 3,1$ mm must receive a screw (screw type 4-40)
Recommended thickness panel : 0,8 mm mini - 2 mm max.

Panel coding keying

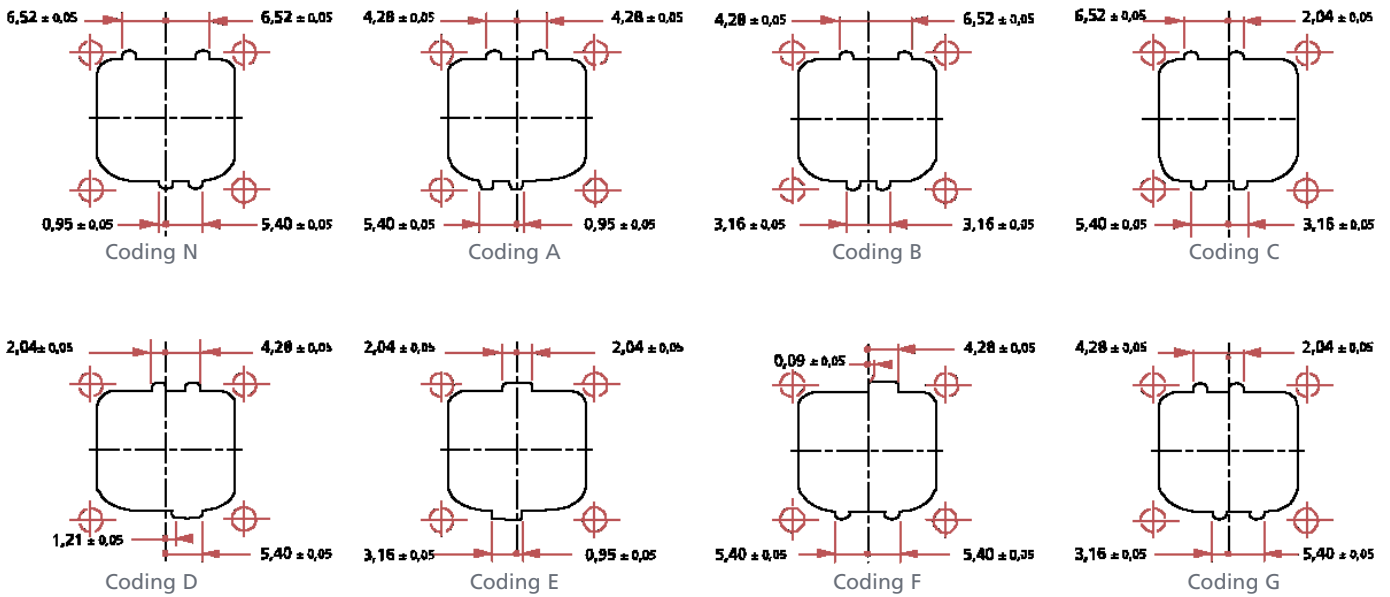

Panel mounting bracket cutout details

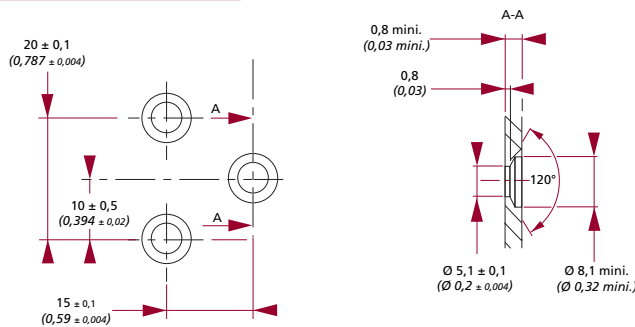

Overall dimensions and characteristics are given for indication guidance only. DEUTSCH reserves the right to modify them for production improvement reasons



www.deutsch.net

DEUTSCH GLOBAL SALES NETWORK

Contact your local sales office for further information:

FRANCE

Connecteurs Electriques
Deutsch
17, rue Lavoisier BP 117
27091 Evreux Cedex 09
FRANCE
Tel: +33 2 32 23 57 00

GERMANY

Compagnie Deutsch GMBH
Fraunhoferstrabe.11b
82152 Martinsried
GERMANY
Tel: +49 89 89 91 570

INDIA

DIPC
104, Prestige Omega, EPIP Zone
1st Phase, White Field Road
BANGALORE 560066
INDIA
Tel: +91 80 28 54 13 25

ISRAEL

Deutsch ECM
P.O. Box 5082
Ashkelon 78150
Southern Industrial Zone
ISRAEL
Tel: +972 8 671 9020

ITALY

Deutsch Italia S.R.L.
Viale Jenner 51
20159 Milano
ITALY
Tel: +39 02 37 617 44

JAPAN

Deutsch Japan Ltd.
4-3-28 Nishidai
Itabashi-ku
Tokyo 175-0045
JAPAN
Tel: +81 3 5922 1345

UNITED KINGDOM

Deutsch UK
Stanier Road
St Leonards on Sea
East Sussex TN38 9RF
UK
Tel: +44 (0) 1424 852721

USA

Deutsch DAO
250 Eddie Jones Way
Oceanside, CA 92054
USA
Tel: +1 (760) 757-7500



DEUTSCH

For more information, technical
assistance or custom solutions:
email ced@deutsch.net

Компания «Океан Электроники» предлагает заключение долгосрочных отношений при поставках импортных электронных компонентов на взаимовыгодных условиях!

Наши преимущества:

- Поставка оригинальных импортных электронных компонентов напрямую с производств Америки, Европы и Азии, а так же с крупнейших складов мира;
- Широкая линейка поставок активных и пассивных импортных электронных компонентов (более 30 млн. наименований);
- Поставка сложных, дефицитных, либо снятых с производства позиций;
- Оперативные сроки поставки под заказ (от 5 рабочих дней);
- Экспресс доставка в любую точку России;
- Помощь Конструкторского Отдела и консультации квалифицированных инженеров;
- Техническая поддержка проекта, помощь в подборе аналогов, поставка прототипов;
- Поставка электронных компонентов под контролем ВП;
- Система менеджмента качества сертифицирована по Международному стандарту ISO 9001;
- При необходимости вся продукция военного и аэрокосмического назначения проходит испытания и сертификацию в лаборатории (по согласованию с заказчиком);
- Поставка специализированных компонентов военного и аэрокосмического уровня качества (Xilinx, Altera, Analog Devices, Intersil, Interpoint, Microsemi, Actel, Aeroflex, Peregrine, VPT, Syfer, Eurofarad, Texas Instruments, MS Kennedy, Miteq, Cobham, E2V, MA-COM, Hittite, Mini-Circuits, General Dynamics и др.);

Компания «Океан Электроники» является официальным дистрибьютором и эксклюзивным представителем в России одного из крупнейших производителей разъемов военного и аэрокосмического назначения «JONHON», а так же официальным дистрибьютором и эксклюзивным представителем в России производителя высокотехнологичных и надежных решений для передачи СВЧ сигналов «FORSTAR».



JONHON

«JONHON» (основан в 1970 г.)

Разъемы специального, военного и аэрокосмического назначения:

(Применяются в военной, авиационной, аэрокосмической, морской, железнодорожной, горно- и нефтедобывающей отраслях промышленности)

«FORSTAR» (основан в 1998 г.)

ВЧ соединители, коаксиальные кабели, кабельные сборки и микроволновые компоненты:

(Применяются в телекоммуникациях гражданского и специального назначения, в средствах связи, РЛС, а так же военной, авиационной и аэрокосмической отраслях промышленности).



Телефон: 8 (812) 309-75-97 (многоканальный)

Факс: 8 (812) 320-03-32

Электронная почта: ocean@oceanchips.ru

Web: <http://oceanchips.ru/>

Адрес: 198099, г. Санкт-Петербург, ул. Калинина, д. 2, корп. 4, лит. А