

MAX17541G 3.3V Output Evaluation Kit

MAX17541G in 3.3V Output-Voltage Application

General Description

The MAX17541G 3.3V EV kit provides a proven design to evaluate the MAX17541G 3.3V high-efficiency, high-voltage, synchronous step-down DC-DC converter. The EV kit generates 3.3V at load currents up to 500mA from a 5V to 42V input supply. The EV kit features a 600kHz fixed switching frequency for optimum efficiency and component size. The EV kit features a forced-PWM control scheme that provides constant switching-frequency operation at all load and line conditions.

Features

- Operates from a 5V to 42V Input Supply
- 3.3V Output Voltage
- 500mA Output Current
- 600kHz Switching Frequency
- Enable/UVLO Input
- Resistor-Programmable UVLO Threshold
- Open-Drain $\overline{\text{RESET}}$ Output
- Overcurrent and Overtemperature Protection
- Proven PCB Layout
- Fully Assembled and Tested

Ordering Information appears at end of data sheet.

Quick Start

Recommended Equipment

- MAX17541G 3.3V EV kit
- 5V to 42V, 2A DC input power supply
- Load capable of sinking 500mA
- Digital voltmeter (DVM)
- Function generator

Procedure

The EV kit is fully assembled and tested. Follow the steps below to verify the board operation. **Caution: Do not turn on power supply until all connections are completed.**

- 1) Set the power supply at a voltage between 5V and 42V. Disable the power supply.
- 2) Connect the positive terminal of the power supply to the VIN PCB pad and the negative terminal to the nearest PGND PCB pad. Connect the positive terminal of the 500mA load to the VOUT PCB pad and the negative terminal to the nearest PGND PCB pad.
- 3) Connect the DVM across the VOUT PCB pad and the nearest PGND PCB pad.
- 4) Turn on the DC power supply.
- 5) Enable the load.
- 6) Verify that the DVM displays 3.3V.

To turn-on/off the part from EN/UVLO, follow the steps below:

- 1) Connect the power supply to the EV kit and turn on the power supply. Set the power supply at a voltage between 5V and 42V.
- 2) Connect the function generator output to the EN/UVLO test loop.
- 3) EN/UVLO rising threshold is 1.24V and falling threshold is 1.11V. Make sure that the voltage-high and voltage-low levels of the function generator output are greater than 1.24V and less than 1.11V, respectively.
- 4) While powering down the EV kit, first disconnect the function generator output from the EN/UVLO test loop and then turn off the DC power supply.

Detailed Description of Hardware

The MAX17541G 3.3V EV kit provides a proven design to evaluate the MAX17541G 3.3V high-efficiency, high-voltage, synchronous step-down DC-DC converter. The EV kit generates 3.3V at load currents up to 500mA from a 5V to 42V input supply. The EV kit features a 600kHz fixed switching frequency for optimum efficiency and component size. The EV kit features a forced-PWM control scheme that provides constant switching-frequency operation at all load and line conditions.

The EV kit includes an EN/UVLO PCB pad to enable control of the converter output. An additional **RESET** PCB pad is available for monitoring the open-drain logic output. The VCC PCB pad helps measure the internal LDO voltage.

Soft-Start Input (SS)

The device utilizes an adjustable soft-start function to limit inrush current during startup. The soft-start time is adjusted by the value of C3, the external capacitor from SS to GND. To adjust the soft-start time, determine C3 using the following formula:

$$C3 = 5.55 \times t_{SS}$$

where t_{SS} is the required soft-start time in milliseconds and C3 is in nanofarads.

Regulator Enable/Undervoltage-Lockout Level (EN/UVLO)

The device features an EN/UVLO input. For normal operation, no shunts should be installed across pins 1-2 or 2-3 on jumper JU1. To disable the output, install a shunt across pins 2-3 on JU1 and the EN/UVLO pin is pulled to GND. See [Table 1](#) for JU1 settings.

Setting the Undervoltage-Lockout Level

The device offers an adjustable input undervoltage-lockout level. Set the voltage at which the device turns on with a resistive voltage-divider connected from VIN to GND (see [Figure 1](#)). Connect the center node of the divider to EN/UVLO.

Choose R1 to be 3.3MΩ and then calculate R2 as follows:

$$R2 = \frac{R1 \times 1.218}{(V_{INU} - 1.218)}$$

where V_{INU} is the voltage at which the device is required to turn on. Ensure that V_{INU} is higher than $0.8 \times V_{OUT}$.

Adjusting the Output Voltage

The device offers an adjustable output voltage. Set the output voltage with a resistive voltage-divider connected from the positive terminal of the output capacitor (V_{OUT}) to GND (see schematic attached to PDF). Connect the center node of the voltage-divider to FB.

To choose the values of R4 and R5, select the parallel combination of R4 and R5, with R_P less than 15kΩ. Once R_P is selected, calculate R4 as follows:

$$R4 = \frac{R_P \times V_{OUT}}{0.9}$$

Calculate R5 as follows:

$$R5 = \frac{R4 \times 0.9}{(V_{OUT} - 0.9)}$$

Table 1. Regulator Enable (EN/UVLO) Jumper JU1 Settings

SHUNT POSITION	EV/UVLO PIN	MAX17541G 3.3V OUTPUT
Not installed*	Connected to the center node of resistor-divider R1 and R2	Enabled, UVLO level set through the R1 and R2 resistor-divider
2-3	Connected to GND	Disabled

*Default position.

EV Kit Performance Report

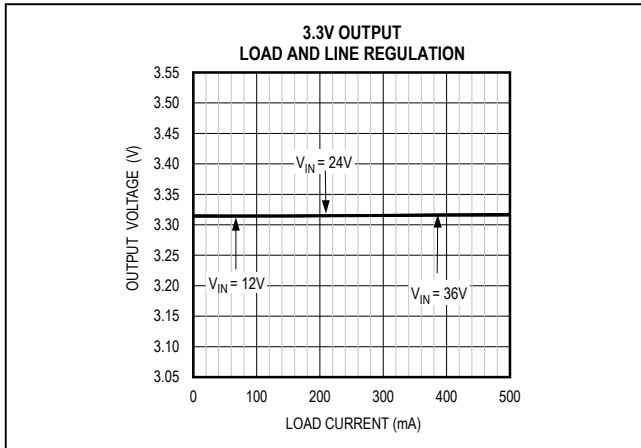

Figure 1. MAX17541G 3.3V Output Load and Line Regulation

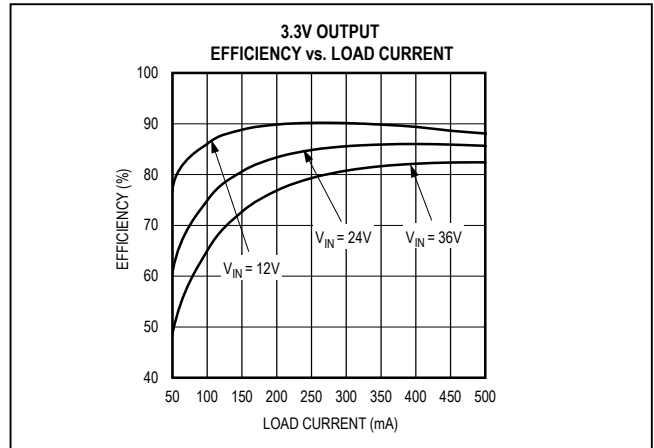

Figure 2. MAX17541G 3.3V Output Efficiency

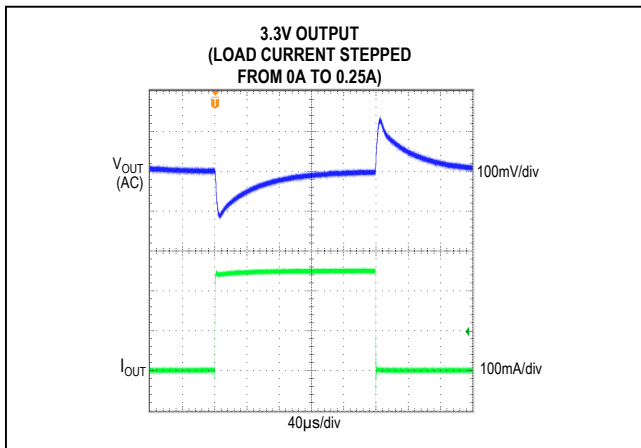

Figure 3. MAX17541G 3.3V Output No Load to 250mA Load Transient

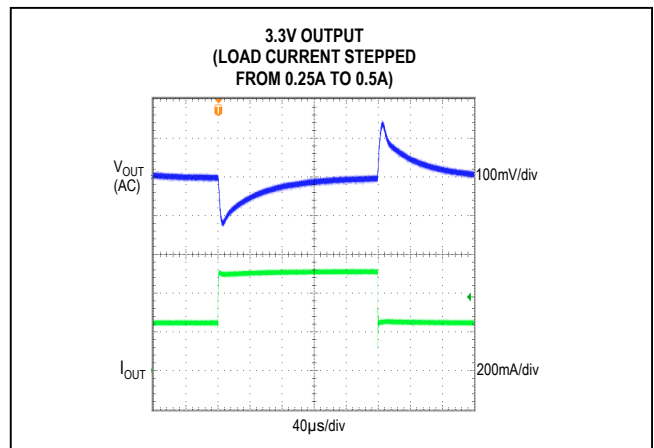

Figure 4. MAX17541G 3.3V Output 250mA to 500mA Load Transient

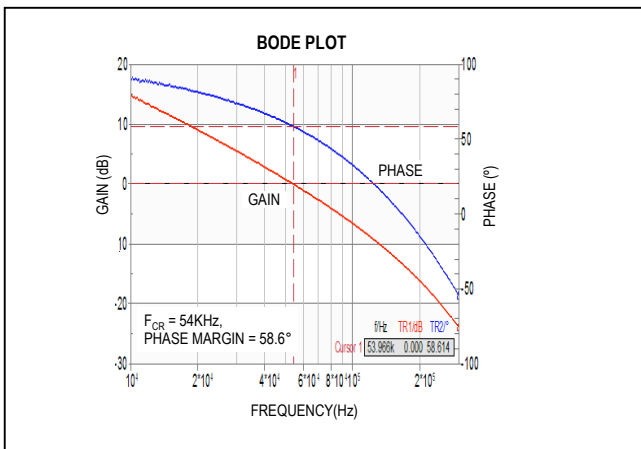

Figure 5. MAX17541G 3.3V Output Full-Load Bode Plot ($V_{IN} = 24V$)

Component Suppliers

SUPPLIER	WEBSITE
Murata Americas	www.murata.com
Panasonic Corp.	www.panasonic.com
Würth Group	www.wg-online.com

Note: Indicate that you are using the MAX17541G when contacting these component suppliers.

Component Information, PCB Layout, and Schematic

See the following links for component information, PCB layout, and schematic:

- [MAX17541G 3.3V EV BOM](#)
- [MAX17541G 3.3V EV PCB Layout](#)
- [MAX17541G 3.3V EV Schematic](#)

Ordering Information

PART	TYPE
MAX17541GTAEVKIT#	EV Kit

#Denotes RoHS compliant.

Revision History

REVISION NUMBER	REVISION DATE	DESCRIPTION	PAGES CHANGED
0	7/15	Initial release	—

For pricing, delivery, and ordering information, please contact Maxim Direct at 1-888-629-4642, or visit Maxim Integrated's website at www.maximintegrated.com.

Maxim Integrated cannot assume responsibility for use of any circuitry other than circuitry entirely embodied in a Maxim Integrated product. No circuit patent licenses are implied. Maxim Integrated reserves the right to change the circuitry and specifications without notice at any time.

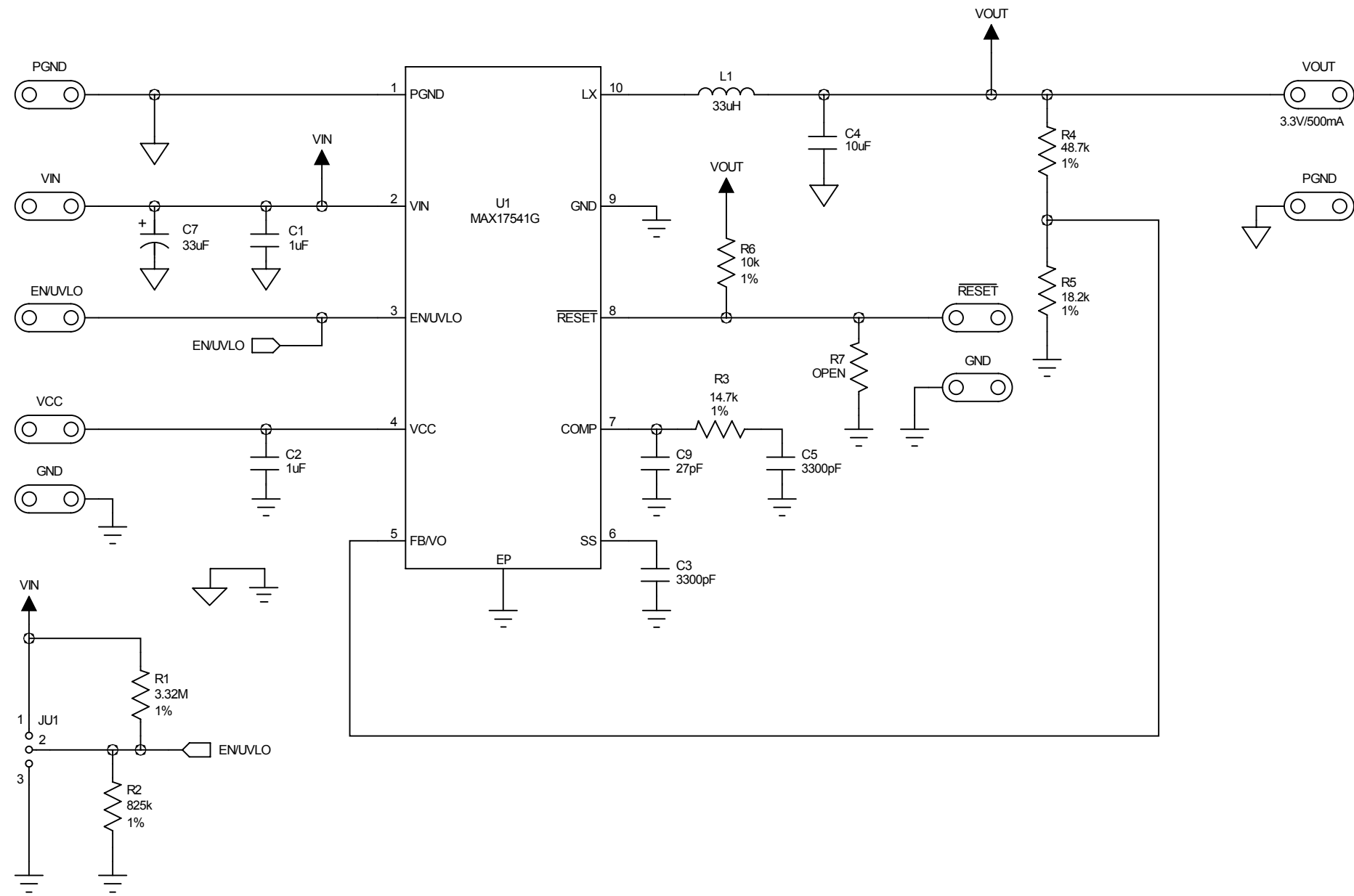

MAX17541GTA EVKIT	
	REV A
PROPERTY OF	
	
LAYER TOP SILKSCREEN	
DATE:	ALL UNITS ARE IN 0.001"

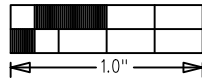
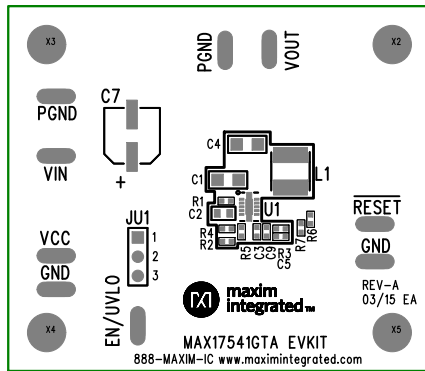

MAX17541GTA EVKIT	
	REV A
PROPERTY OF	
	
LAYER	TOP SOLDERMASK
DATE:	ALL UNITS ARE IN 0.001"

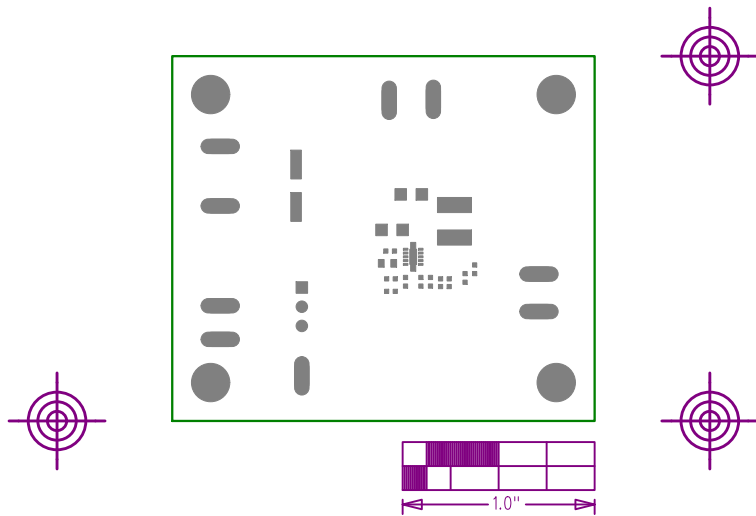

MAX17541GTA EVKIT	
	REV A
PROPERTY OF	
	
LAYER	COMPONENT SIDE
DATE:	ALL UNITS ARE IN 0.001"

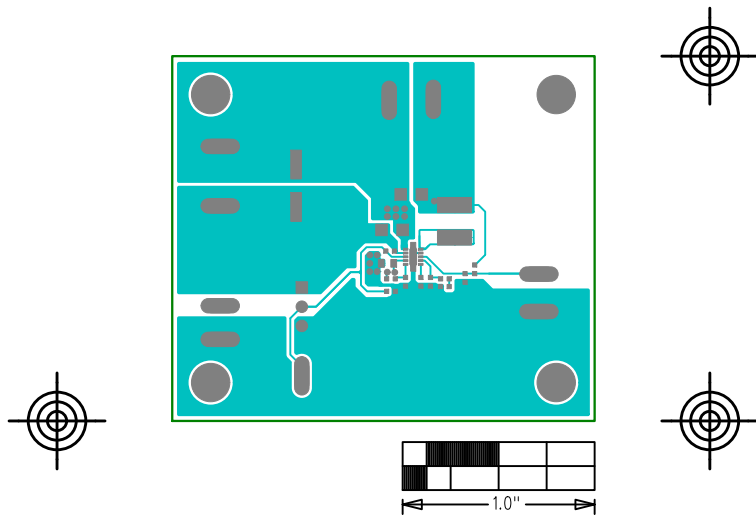

MAX17541GTA EVKIT	
	REV A
PROPERTY OF	
	
LAYER	SOLDER SIDE
DATE:	ALL UNITS ARE IN 0.001"

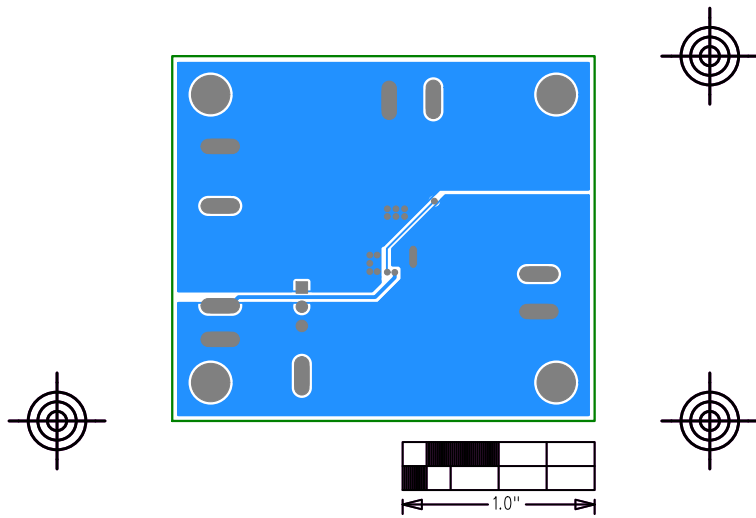

MAX17541GTA EVKIT	
	REV A
PROPERTY OF	
	
LAYER BOTTOM SOLDERMASK	
DATE:	ALL UNITS ARE IN 0.001"

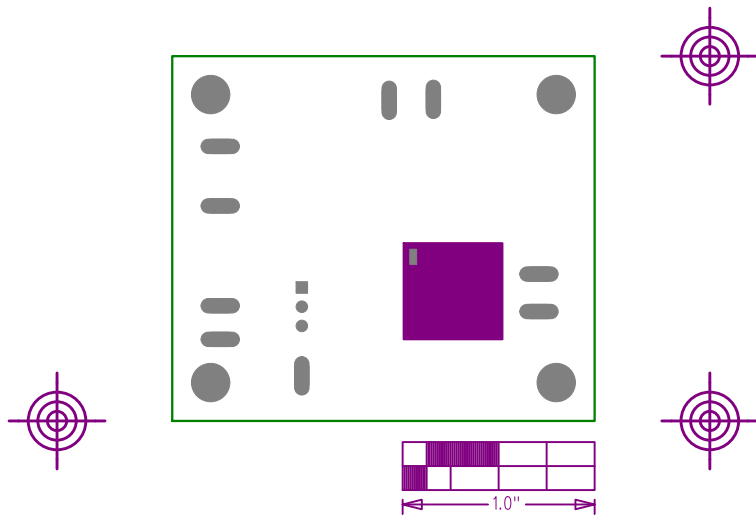

BILL OF MATERIALS (Revision 7/15)

Reference	Description	Quantity	Designator	Part Number
1	1μF ±10%, 50V X7R ceramic capacitor (1206)	1	C1	Murata GRM31MR71H105K
2	1μF ±10%, 6.3V X7R ceramic capacitor (0603)	1	C2	Murata GRM188R70J105K
3	3300pF ±10%, 50V X7R ceramic capacitor (0402)	1	C3	Murata GRM155R71H332K
4	10uF ±10%, 6.3V X7R ceramic capacitor (1206)	1	C4	Murata GRM31CR70J106K
5	3300pF ±10%, 50V X7R ceramic capacitor (0402)	1	C5	Murata GRM155R71H332K
6	33uF 50V aluminum electrolytic (D=6.3mm)	1	C7	Panasonic EEE-FK1H330XP
7	27pF ±5%, 50V COG ceramic capacitor (0402)	1	C9	Murata GRM1555C1H270J
8	3-pin header (36-pin header 0.1" centers)	1	JU1	Sullins: PTC36SAAN
9	33uH Inductor (5mm x 5mm x 4mm)	1	L1	Würth Electronics 74404054330
10	3.32M ohm ±1%, resistor (0402)	1	R1	
11	825k ohm ±1%, resistor (0402)	1	R2	
12	14.7k ohm ±1%, resistor (0402)	1	R3	
13	48.7k ±1% ohm resistor (0402)	1	R4	
14	18.2k ±1% ohm resistor (0402)	1	R5	
15	10k ohm ±1%, resistor (0402)	1	R6	
16	Not installed, resistor (0402)	0	R7	
17	Buck Converter (10TDFN 3mmx2mm) MAX17541GATB+	1	U1	MAX17541GATB+
18	Shunt	1	See Jumper Table	SULLINS STC02SYAN

Jumper Table	
JUMPER	SHUNT POSITION
JU1	1-2

Компания «Океан Электроники» предлагает заключение долгосрочных отношений при поставках импортных электронных компонентов на взаимовыгодных условиях!

Наши преимущества:

- Поставка оригинальных импортных электронных компонентов напрямую с производств Америки, Европы и Азии, а так же с крупнейших складов мира;
- Широкая линейка поставок активных и пассивных импортных электронных компонентов (более 30 млн. наименований);
- Поставка сложных, дефицитных, либо снятых с производства позиций;
- Оперативные сроки поставки под заказ (от 5 рабочих дней);
- Экспресс доставка в любую точку России;
- Помощь Конструкторского Отдела и консультации квалифицированных инженеров;
- Техническая поддержка проекта, помощь в подборе аналогов, поставка прототипов;
- Поставка электронных компонентов под контролем ВП;
- Система менеджмента качества сертифицирована по Международному стандарту ISO 9001;
- При необходимости вся продукция военного и аэрокосмического назначения проходит испытания и сертификацию в лаборатории (по согласованию с заказчиком);
- Поставка специализированных компонентов военного и аэрокосмического уровня качества (Xilinx, Altera, Analog Devices, Intersil, Interpoint, Microsemi, Actel, Aeroflex, Peregrine, VPT, Syfer, Eurofarad, Texas Instruments, MS Kennedy, Miteq, Cobham, E2V, MA-COM, Hittite, Mini-Circuits, General Dynamics и др.);

Компания «Океан Электроники» является официальным дистрибьютором и эксклюзивным представителем в России одного из крупнейших производителей разъемов военного и аэрокосмического назначения «JONHON», а так же официальным дистрибьютором и эксклюзивным представителем в России производителя высокотехнологичных и надежных решений для передачи СВЧ сигналов «FORSTAR».



JONHON

«JONHON» (основан в 1970 г.)

Разъемы специального, военного и аэрокосмического назначения:

(Применяются в военной, авиационной, аэрокосмической, морской, железнодорожной, горно- и нефтедобывающей отраслях промышленности)

«FORSTAR» (основан в 1998 г.)

ВЧ соединители, коаксиальные кабели,
кабельные сборки и микроволновые компоненты:

(Применяются в телекоммуникациях гражданского и специального назначения, в средствах связи, РЛС, а так же военной, авиационной и аэрокосмической отраслях промышленности).



Телефон: 8 (812) 309-75-97 (многоканальный)

Факс: 8 (812) 320-03-32

Электронная почта: ocean@oceanchips.ru

Web: <http://oceanchips.ru/>

Адрес: 198099, г. Санкт-Петербург, ул. Калинина, д. 2, корп. 4, лит. А