



**Relay for control panel of  
1c 10A, 2c 5A and 1a 16A**

# HN RELAYS (AHN)



**RoHS compliant**

### FEATURES

- 1. Slim and compact size**  
20% smaller (width and height) than existing model\* (with the condition of screw terminal socket for DIN rail)  
\*Compared with our HC/HJ relay.
- 2. High-capacity**  
Max. switching current:  
16 A (for 1 Form C type at AC load)
- 3. Slim screw terminal sockets and PC board terminal sockets are available**

### TYPICAL APPLICATIONS

Control panels  
Power supply units  
Molding machines  
Machine tools  
Welding equipment  
Agricultural equipment  
Office equipment  
Vending machines  
Communications equipment  
Amusement machines, etc.

## ORDERING INFORMATION



## TYPES

### 1. Plug-in type

Nominal coil voltage	1 Form C	2 Form C
	Part No.	Part No.
5V DC	AHN12005	AHN22005N
6V DC	AHN12006	AHN22006N
12V DC	AHN12012	AHN22012N
24V DC	AHN12024	AHN22024N
48V DC	AHN12048	AHN22048N
100V DC	AHN120X0	AHN220X0N
110V DC	AHN120X1	AHN220X1N
12V AC	AHN11012	AHN21012N
24V AC	AHN11024	AHN21024N
100/110V AC	AHN110X0	AHN210X0N
110/120V AC	AHN110X1	AHN210X1N
200/220V AC	AHN110Y0	AHN210Y0N
220/240V AC	AHN110Y2	AHN210Y2N

Standard packing: Carton: 50 pcs.; Case: 500 pcs.

### 2. Plug-in type (with LED indication)

Nominal coil voltage	1 Form C	2 Form C
	Part No.	Part No.
5V DC	AHN12105	AHN22105N
6V DC	AHN12106	AHN22106N
12V DC	AHN12112	AHN22112N
24V DC	AHN12124	AHN22124N
48V DC	AHN12148	AHN22148N
100V DC	AHN121X0	AHN221X0N
110V DC	AHN121X1	AHN221X1N
12V AC	AHN11112	AHN21112N
24V AC	AHN11124	AHN21124N
100/110V AC	AHN111X0	AHN211X0N
110/120V AC	AHN111X1	AHN211X1N
200/220V AC	AHN111Y0	AHN211Y0N
220/240V AC	AHN111Y2	AHN211Y2N

Standard packing: Carton: 50 pcs.; Case: 500 pcs.

### 3. Plug-in type (with diode)

Nominal coil voltage	1 Form C	2 Form C
	Part No.	Part No.
5V DC	AHN12205	AHN22205N
6V DC	AHN12206	AHN22206N
12V DC	AHN12212	AHN22212N
24V DC	AHN12224	AHN22224N
48V DC	AHN12248	AHN22248N
100V DC	AHN122X0	AHN222X0N
110V DC	AHN122X1	AHN222X1N

Standard packing: Carton: 50 pcs.; Case: 500 pcs.

### 4. Plug-in type (with diode and LED indication)

Nominal coil voltage	1 Form C	2 Form C
	Part No.	Part No.
5V DC	AHN12305	AHN22305N
6V DC	AHN12306	AHN22306N
12V DC	AHN12312	AHN22312N
24V DC	AHN12324	AHN22324N
48V DC	AHN12348	AHN22348N
100V DC	AHN123X0	AHN223X0N
110V DC	AHN123X1	AHN223X1N

Standard packing: Carton: 50 pcs.; Case: 500 pcs.

### 5. TM type

Nominal coil voltage	1 Form A
	Part No.
5V DC	AHN36005
6V DC	AHN36006
12V DC	AHN36012
24V DC	AHN36024
48V DC	AHN36048
100V DC	AHN360X0
110V DC	AHN360X1
12V AC	AHN35012
24V AC	AHN35024
100/110V AC	AHN350X0
110/120V AC	AHN350X1
200/220V AC	AHN350Y0
220/240V AC	AHN350Y2

Standard packing: Carton: 50 pcs.; Case: 500 pcs.

## RATING

### 1. Coil data

#### 1) DC coils

Nominal coil voltage	Pick-up voltage (at 20°C 68°F)	Drop-out voltage (at 20°C 68°F)	Nominal coil current [±20%]	Coil resistance (at 20°C 68°F)	Nominal operating power	Max. applied voltage (at 20°C 68°F)
5V DC	70%V or less of nominal voltage (Initial)	15%V or more of nominal voltage (Initial)	106.4mA	47Ω [±10%]	0.53W	170%V of nominal voltage
6V DC			88.2mA	68Ω [±10%]		
12V DC			44.4mA	270Ω [±10%]		
24V DC			22.0mA	1,090Ω [±10%]		
48V DC			11.0mA	4,350Ω [±10%]		
100V DC			5.3mA	18,870Ω [±10%]		
110V DC			4.8mA	22,830Ω [±10%]		

#### 2) AC coils (50/60Hz)

Nominal coil voltage	Pick-up voltage (at 20°C 68°F)	Drop-out voltage (at 20°C 68°F)	Nominal coil current [±20%]		Nominal operating power		Max. applied voltage (at 20°C 68°F)
			50Hz	60Hz	50Hz	60Hz	
12V AC	80%V or less of nominal voltage (Initial)	30%V or more of nominal voltage (Initial)	93mA	75mA	Approx. 1.1 to 1.4 V A	Approx. 0.9 to 1.2 V A	140%V of nominal voltage
24V AC			46.5mA	37.5mA			
100/110V AC			11.0/13.0mA	9.0/10.6mA			
110/120V AC			10.0/11.8mA	8.2/9.7mA			
200/220V AC			5.5/6.5mA	4.5/5.3mA			
220/240V AC			5.0/5.9mA	4.1/4.8mA			

## 2. Specifications (Plug-in Standard type and TM type)

Characteristics	Item	Specifications			
		1 Form C	2 Form C	1 Form A (TM type)	
Contact	Arrangement				
	Contact resistance (Initial)	Max. 100 mΩ (By voltage drop 6 V DC 1A)	Max. 50 mΩ (By voltage drop 6 V DC 1A)	Max. 100 mΩ (By voltage drop 6 V DC 1A)	
	Contact material	AgSnO <sub>2</sub> type	AgNi type	AgSnO <sub>2</sub> type	
Rating	Nominal switching capacity (resistive load)	10A 250V AC, 10A 30V DC	5A 250V AC, 5A 30V DC	16A 250V AC, 16A 30V DC	
	Max. switching power (resistive load)	4,000VA, 300W	1,250VA, 150W	4,000VA, 480W	
	Max. switching voltage	250V AC, 30V DC			
	Max. switching current	16A (at AC load), 10A (at DC load)	5A	16A	
	Nominal operating power	0.53W, 0.9VA			
	Min. switching capacity (Reference value)*1	100mA 5V DC	10mA 5V DC	100mA 5V DC	
Electrical characteristics	Insulation resistance (Initial)	Min. 1,000MΩ (at 500V DC) Measurement at same location as "Breakdown voltage" section.			
	Breakdown voltage (Initial)	Between open contacts	1,000 Vrms for 1min. (Detection current: 10mA.)		
		Between contact sets	—	3,000 Vrms for 1min. (Detection current: 10mA.)	—
		Between contact and coil	5,000 Vrms for 1min. (Detection current: 10mA.)		
	Temperature rise (coil) (at 70°C 158°F)	Max. 60°C 140°F (By resistive method, nominal coil voltage)			
	Operate time (at 20°C 68°F)*2	Max. 15ms (Nominal coil voltage applied to the coil, excluding contact bounce time.)			
Release time (at 20°C 68°F)*2	Max. 5ms (Nominal coil voltage applied to the coil, excluding contact bounce time.) (without diode)/Max. 20ms (with diode)				
Mechanical characteristics	Shock resistance	Functional	Min. 100 m/s <sup>2</sup> (Half-wave pulse of sine wave: 11 ms; detection time: 10μs.)		
		Destructive	Min. 1,000 m/s <sup>2</sup> (Half-wave pulse of sine wave: 6 ms.)		
	Vibration resistance	Functional	10 to 55 Hz at double amplitude of 1.5 mm (Detection time: 10μs.)		
		Destructive	10 to 55 Hz at double amplitude of 1.5 mm		
Expected life	Mechanical	AC: Min. 10 <sup>7</sup> ; DC: Min. 2×10 <sup>7</sup> (at 300 times/min.)			
	Electrical (at nominal switching capacity)	Min. 10 <sup>5</sup> (at 20 times/min.)		Min. 10 <sup>5</sup> (at 10 times/min.)	
Conditions	Conditions for operation, transport and storage*3 (Not freezing and condensing at low temperature)	Ambient temperature: -40°C to +70°C -40°F to +158°F Humidity: 5 to 85% R.H. (Not freezing and condensing at low temperature)			
	Max. Operating speed	20 times/min. (at nominal switching capacity)		10 times/min. (at nominal switching capacity)	
Unit weight		Approx. 19 g .67 oz	Approx. 17 g .60 oz	Approx. 19 g .67 oz	

Notes: \*1. This value can change due to the switching frequency, environmental conditions and desired reliability level, therefore it is recommended to check this with the actual load.

\*2. For the AC coil types, the operate/release time will differ depending on the phase.

\*3. The upper limit of the ambient temperature is the maximum temperature that can satisfy the coil temperature rise value. Refer to Usage, transport and storage conditions in NOTES.

## REFERENCE DATA

1-(1). Max. switching capacity  
(1 Form C and 1 Form A)



1-(2). Max. switching capacity (2 Form C)



2-(1). Coil temperature rise (1 Form C/AC and 1 Form A/AC types)

Measured portion: Inside the coil  
Ambient temperature: 70°C 158°F



2-(2). Coil temperature rise (1 Form C/DC and 1 Form A/DC types)

Measured portion: Inside the coil  
Ambient temperature: 70°C 158°F



2-(3). Coil temperature rise (2 Form C/AC type)

Measured portion: Inside the coil  
Ambient temperature: 70°C 158°F



2-(4). Coil temperature rise (2 Form C/DC type)

Measured portion: Inside the coil  
Ambient temperature: 70°C 158°F



## DIMENSIONS (mm inch)

### 1. Plug-in type 1 Form C

**CAD Data**

The CAD data of the products with a **CAD Data** mark can be downloaded from: <http://industrial.panasonic.com/ac/e/>



### External dimensions



### Schematic (Bottom view) Standard type



### With LED AC type

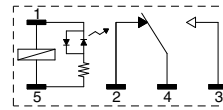

### With LED DC type

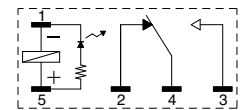

### With Diode type

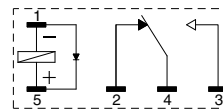

### With Diode and LED type

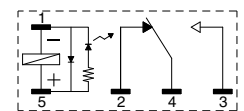

### Dimension:

Less than 1mm .039inch:

Min. 1mm .039inch less than 3mm .118 inch:

Min. 3mm .118 inch:

### Tolerance

±0.1 ±.004

±0.2 ±.008

±0.3 ±.012

2. Plug-in type 2 Form C

CAD Data



External dimensions



Schematic (Bottom view)  
Standard type



With LED AC type

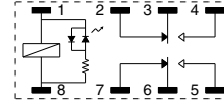

With LED DC type

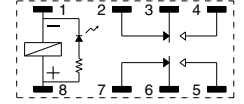

With Diode type

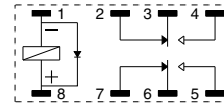

With Diode and LED type

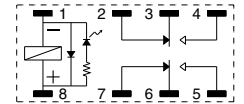

Dimension:

Less than 1mm .039inch:

Min. 1mm .039inch less than 3mm .118 inch: ±0.2 ±.008

Min. 3mm .118 inch:

Tolerance

±0.1 ±.004

±0.2 ±.008

±0.3 ±.012

3. TM type 1 Form A

CAD Data



External dimensions

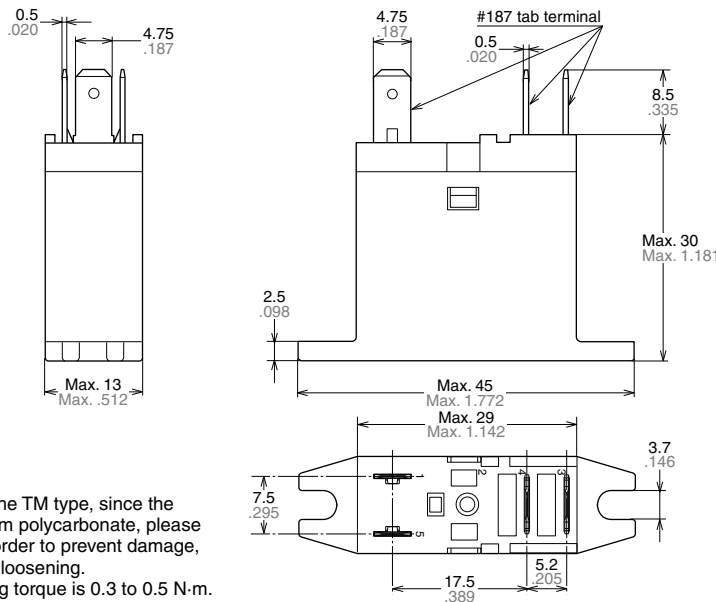

Schematic



Mounting hole dimensions



- Notes: 1. When mounting the TM type, since the cover is made from polycarbonate, please use a washer in order to prevent damage, deformation, and loosening.  
2. Suitable tightening torque is 0.3 to 0.5 N·m.

Dimension:

Less than 1mm .039inch:

Min. 1mm .039inch less than 3mm .118 inch: ±0.2 ±.008

Min. 3mm .118 inch:

Tolerance

±0.1 ±.004

±0.2 ±.008

±0.3 ±.012

SAFETY STANDARDS

	File No.	Certification authority: UL/C-UL	File No.	Certification authority: VDE
1 Form C	E43149*	10A 277V AC, 10A 30V DC, TV-5	40012003	10A 250V AC (cosφ=1.0), 10A 30V DC (0ms)
2 Form C	E43149*	5A 277V AC, 5A 30V DC, TV-3	40012003	5A 250V AC (cosφ=1.0), 5A 30V DC (0ms)
1 Form A (TM type)	E43149*	16A 277V AC, 16A 30V DC	—	**

\* CSA standard: Certified by C-UL

\*\* Please consult us.

## NOTES

**1. For cautions for use, please read “General Application Guidelines” on page B-1.**

### 2. Coil applied voltage

To ensure proper operation, the voltage applied to both terminals of the coil should be  $\pm 5\%$  (at 20°C 68°F) the rated operating voltage of the coil.

Also, be aware that the pick-up and drop-out voltages will fluctuate depending on the ambient temperature and operating conditions.

### 3. LED indications

The light of the light emitting diode is what displays operation. If voltage remains after relay dropout, the LED might illuminate briefly.

### 4. Switching lifetime

The switching lifetime is defined under the standard test condition specified in the JIS C 5442(\*2) standard (temperature 15 to 35°C 59 to 95°F, humidity 25 to 75% R.H.). Check this with the real device as it is affected by coil driving circuit, load type, activation frequency, activation phase, ambient conditions and other factors.

Also, be especially careful of loads such as those listed below.

1) When used for AC load-operating and the operating phase is synchronous.

Rocking and fusing can easily occur due to contact shifting.

2) High-frequency load-operating

When high-frequency opening and closing of the relay is performed with a load that causes arcs at the contacts, nitrogen and oxygen in the air is fused by the arc energy and  $\text{HNO}_3$  is formed. This can corrode metal materials.

Three countermeasures for these are listed here.

(1) Incorporate an arc-extinguishing circuit.

(2) Lower the operating frequency

(3) Lower the ambient humidity

### 5. Direct mount type (TM type)

If the current to the connection terminal will exceed 10 A, we recommend connecting with solder. If you are going to use a tab terminal when the current will exceed 10 A, make sure to verify the temperature rise on the receptacle side under actual conditions before using. Please be careful, because excessive stress on the TM terminal can cause fluctuations in characteristics and damage.

### 6. Conditions for operation, transport and storage

1) Ambient temperature, humidity, and atmospheric pressure during usage, transport, and storage of the relay:

(1) Temperature:

–40 to +70°C – 40 to +158°F

(2) Humidity: 5 to 85% RH

(Avoid freezing and condensation.)

The humidity range varies with the temperature. Use within the range indicated in the graph below.

Temperature and humidity range for usage, transport, and storage



(3) Atmospheric pressure: 86 to 106 kPa

2) Condensation

Condensation forms when there is a sudden change in temperature under high temperature and high humidity conditions. Condensation will cause deterioration of the relay insulation.

3) Freezing

Condensation or other moisture may freeze on the relay when the temperatures is lower than 0°C 32°F. This causes problems such as sticking of movable parts or operational time lags.

4) Low temperature, low humidity environments

The plastic becomes brittle if the relay is exposed to a low temperature, low humidity environment for long periods of time.

### 7. Diode characteristics

1) Reverse breakdown voltage:

Min. 1,000V (with diode type)

Min. 400V (with diode and LED indication type)

### 8. Diode type

Since the diode inside the relay coil are designed to absorb the counter emf, the element may be damaged if a large surge, etc., is applied to the diode.

If there is the possibility of a large surge voltage from the outside, please implement measures to absorb it.

**9. Please connect DC coil types with LED and built-in diode correctly by verifying the coil polarity (“+” and “–”). Connecting with reverse polarity will cause the LED not to light and damage the built-in diode due to its specification.**

### 10. Installation

If you will be installing adjacent to other relays, please keep a distance of at least 5 mm from the relay.

---

Please contact .....

**Panasonic Corporation**

Electromechanical Control Business Division

■ 1006, Oaza Kadoma, Kadoma-shi, Osaka 571-8506, Japan  
[industrial.panasonic.com/ac/e/](http://industrial.panasonic.com/ac/e/)

**Panasonic**<sup>®</sup>

©Panasonic Corporation 2018

# Mouser Electronics

Authorized Distributor

Click to View Pricing, Inventory, Delivery & Lifecycle Information:

## Panasonic:

[AHN36012](#) [AHN210X1](#) [AHN22012](#) [AHN11024](#) [AHN110X1](#) [AHN111Y2](#) [AHN12005](#) [AHN12012](#) [AHN12024](#)  
[AHN12212](#) [AHN12224](#) [AHN12324](#) [AHN21012](#) [AHN21024](#) [AHN210X0](#) [AHN210Y0](#) [AHN210Y2](#) [AHN21112](#)  
[AHN21124](#) [AHN211X0](#) [AHN211X1](#) [AHN211Y0](#) [AHN211Y2](#) [AHN22005](#) [AHN22006](#) [AHN22024](#) [AHN22048](#)  
[AHN220X0](#) [AHN220X1](#) [AHN22105](#) [AHN22106](#) [AHN22112](#) [AHN22124](#) [AHN22148](#) [AHN221X0](#) [AHN221X1](#)  
[AHN22205](#) [AHN22206](#) [AHN22212](#) [AHN22224](#) [AHN22248](#) [AHN222X0](#) [AHN222X1](#) [AHN22305](#) [AHN22306](#)  
[AHN22312](#) [AHN22324](#) [AHN22348](#) [AHN223X0](#) [AHN223X1](#) [AHN35024](#) [AHN350X1](#) [AHN36005](#) [AHN36024](#)  
[AHN360X1](#) [AHN12105](#) [AHN36006](#) [AHN21012N](#) [AHN22205N](#) [AHN22212N](#) [AHN223X0N](#) [AHN22224N](#)  
[AHN220X1N](#) [AHN221X1N](#) [AHN222X1N](#) [AHN211X0N](#) [AHN22106N](#) [AHN22006N](#) [AHN222X0N](#) [AHN22312N](#)  
[AHN22348N](#) [AHN210X1N](#) [AHN220X0N](#) [AHN221X0N](#) [AHN22048N](#) [AHN22206N](#) [AHN223X1N](#) [AHN22248N](#)  
[AHN22306N](#) [AHN22005N](#) [AHN22105N](#) [AHN210Y2N](#) [AHN210X0N](#) [AHN21112N](#) [AHN211Y2N](#) [AHN21024N](#)  
[AHN22124N](#) [AHN12112](#) [AHN22012N](#) [AHN350Y2](#) [AHN22305N](#) [AHN22112N](#) [AHN22148N](#) [AHN211X1N](#)  
[AHN21124N](#) [AHN22324N](#) [AHN22024N](#)



Компания «Океан Электроники» предлагает заключение долгосрочных отношений при поставках импортных электронных компонентов на взаимовыгодных условиях!

Наши преимущества:

- Поставка оригинальных импортных электронных компонентов напрямую с производств Америки, Европы и Азии, а так же с крупнейших складов мира;
- Широкая линейка поставок активных и пассивных импортных электронных компонентов (более 30 млн. наименований);
- Поставка сложных, дефицитных, либо снятых с производства позиций;
- Оперативные сроки поставки под заказ (от 5 рабочих дней);
- Экспресс доставка в любую точку России;
- Помощь Конструкторского Отдела и консультации квалифицированных инженеров;
- Техническая поддержка проекта, помощь в подборе аналогов, поставка прототипов;
- Поставка электронных компонентов под контролем ВП;
- Система менеджмента качества сертифицирована по Международному стандарту ISO 9001;
- При необходимости вся продукция военного и аэрокосмического назначения проходит испытания и сертификацию в лаборатории (по согласованию с заказчиком);
- Поставка специализированных компонентов военного и аэрокосмического уровня качества (Xilinx, Altera, Analog Devices, Intersil, Interpoint, Microsemi, Actel, Aeroflex, Peregrine, VPT, Syfer, Eurofarad, Texas Instruments, MS Kennedy, Miteq, Cobham, E2V, MA-COM, Hittite, Mini-Circuits, General Dynamics и др.);

Компания «Океан Электроники» является официальным дистрибьютором и эксклюзивным представителем в России одного из крупнейших производителей разъемов военного и аэрокосмического назначения «JONHON», а так же официальным дистрибьютором и эксклюзивным представителем в России производителя высокотехнологичных и надежных решений для передачи СВЧ сигналов «FORSTAR».



## JONHON

«JONHON» (основан в 1970 г.)

Разъемы специального, военного и аэрокосмического назначения:

(Применяются в военной, авиационной, аэрокосмической, морской, железнодорожной, горно- и нефтедобывающей отраслях промышленности)

«FORSTAR» (основан в 1998 г.)

ВЧ соединители, коаксиальные кабели,  
кабельные сборки и микроволновые компоненты:

(Применяются в телекоммуникациях гражданского и специального назначения, в средствах связи, РЛС, а так же военной, авиационной и аэрокосмической отраслях промышленности).



Телефон: 8 (812) 309-75-97 (многоканальный)

Факс: 8 (812) 320-03-32

Электронная почта: [ocean@oceanchips.ru](mailto:ocean@oceanchips.ru)

Web: <http://oceanchips.ru/>

Адрес: 198099, г. Санкт-Петербург, ул. Калинина, д. 2, корп. 4, лит. А