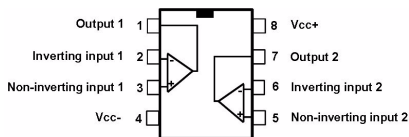


## Rail-to-rail 1.8 V high-speed dual comparator

TS3022  
SO-8/MiniSO-8



Pin connections (top view)



### Features

- Propagation delay: 38 ns
- Low current consumption: 73  $\mu$ A
- Rail-to-rail inputs
- Push-pull outputs
- Supply operation from 1.8 to 5 V
- Wide temperature range: -40 °C to 125 °C
- ESD tolerance: 5 kV HBM, 300 V MM
- Latch-up immunity: 200 mA
- SMD packages
- Automotive qualification

### Applications

- Telecom
- Instrumentation
- Signal conditioning
- High-speed sampling systems
- Portable communication systems
- Automotive

#### Maturity status link

[TS3022](#)

### Description

The **TS3022** dual comparator features a high speed response time with rail-to-rail inputs. With a supply voltage specified from 2 to 5 V, this comparator can operate over a wide temperature range: -40 °C to 125 °C.

The **TS3022** comparator offers micropower consumption as low as a few tens of microamperes thus providing an excellent ratio of power consumption current versus response time.

The **TS3022** includes push-pull outputs and is available in small packages (SMD): SO-8 and MiniSO-8.

# 1 Absolute maximum ratings and operating conditions

**Table 1. Absolute maximum ratings (AMR)**

Symbol	Parameter	Value	Unit	
$V_{CC}$	Supply voltage <sup>(1)</sup>	5.5	V	
$V_{ID}$	Differential input voltage <sup>(2)</sup>	±5		
$V_{IN}$	Input voltage range	$(V_{CC-}) - 0.3$ to $(V_{CC+}) + 0.3$		
$R_{thja}$	Thermal resistance junction-to-ambient <sup>(3)</sup>	SO-8	125	°C/W
		MiniSO-8	90	
$R_{thjc}$	Thermal resistance junction-to-case <sup>(3)</sup>	SO-8	40	
		MiniSO-8	39	
$T_{stg}$	Storage temperature	-65 to 150	°C	
$T_j$	Junction temperature	150		
$T_{LEAD}$	Lead temperature (soldering 10 s)	260		
ESD	HBM: human body model <sup>(4)</sup>	5000	V	
	MM: machine model <sup>(5)</sup>	300		
	CDM : charged device model for TS3022IDT and TS3022IST <sup>(6)</sup>	1500		
	CDM : charged device model for TS3022IYST <sup>(6)</sup>	1400		
	Latch-up immunity	200	mA	

1. All voltage values, except the differential voltage are referenced to  $(V_{CC-})$ .  $V_{CC}$  is defined as the difference between  $V_{CC+}$  and  $V_{CC-}$ .
2. The magnitude of the input and output voltages must never exceed the supply rail  $\pm 0.3$  V.
3. Short-circuits can cause excessive heating. These are typical values.
4. Human body model: a 100 pF capacitor is charged to the specified voltage, then discharged through a 1.5 kΩ resistor between two pins of the device. This is done for all couples of connected pin combinations while the other pins are floating.
5. Machine model: a 200 pF capacitor is charged to the specified voltage, then discharged directly between two pins of the device with no external series resistor (internal resistor < 5 Ω). This is done for all couples of connected pin combinations while the other pins are floating.
6. Charged device model: all pins and the package are charged together to the specified voltage and then discharged directly to the ground through only one pin. This is done for all pins.

**Table 2. Operating conditions**

Symbol	Parameter	Value	Unit	
$V_{CC}$	Supply voltage	0 °C < $T_{amb}$ < +125 °C	1.8 to 5	V
		-40 °C < $T_{amb}$ < +125 °C	2 to 5	
$V_{icm}$	Common mode input voltage range	-40 °C < $T_{amb}$ < 85 °C	$(V_{CC-}) - 0.2$ to $(V_{CC+}) + 0.2$	
		+85 °C < $T_{amb}$ < +125 °C	$(V_{CC-})$ to $(V_{CC+})$	
$T_{oper}$	Operating temperature range	-40 to 125	°C	

## 2 Electrical characteristics

**Table 3. Electrical characteristics at  $V_{CC+} = 2\text{ V}$ ,  $V_{CC-} = 0\text{ V}$ ,  $T_{amb} = 25\text{ °C}$ , and full  $V_{icm}$  range (unless otherwise specified)**

Symbol	Parameter	Test conditions <sup>(1)</sup>	Min.	Typ.	Max.	Unit
$V_{IO}$	Input offset voltage	-40 °C < $T_{amb}$ < +125 °C, TS3021A		0.5	6	mV
					7	
$\Delta V_{IO}/\Delta T$	Input offset voltage drift	-40 °C < $T_{amb}$ < 125 °C		3	20	$\mu\text{V}/\text{°C}$
$I_{IO}$	Input offset current <sup>(2)</sup>	$T_{amb}$		1	20	nA
		-40 °C < $T_{amb}$ < +125 °C			100	
$I_{IB}$	Input bias current <sup>(2)</sup>	$T_{amb}$		86	160	nA
		-40 °C < $T_{amb}$ < 125 °C			300	
$I_{CC}$	Supply current	No load, output high, $V_{icm} = 0\text{ V}$		73	90	$\mu\text{A}$
		No load, output high, $V_{icm} = 0\text{ V}$ , -40 °C < $T_{amb}$ < 125 °C			115	
		No load, output low, $V_{icm} = 0\text{ V}$		84	105	
		No load, output low, $V_{icm} = 0\text{ V}$ , -40 °C < $T_{amb}$ < 125 °C			125	
$I_{SC}$	Short-circuit current	Source		9		mA
		Sink		10		
$V_{OH}$	Output voltage high	$I_{source} = 1\text{ mA}$	1.88	1.92		V
		-40 °C < $T_{amb}$ < 125 °C	1.80			
$V_{OL}$	Output voltage low	$I_{sink} = 1\text{ mA}$		60	100	mV
		-40 °C < $T_{amb}$ < 125 °C			150	
CMRR	Common mode rejection ratio	$0 < V_{icm} < 2\text{ V}$		67		dB
SVR	Supply voltage rejection	$\Delta V_{CC} = 2\text{ to }5\text{ V}$	58	73		
$TP_{LH}$	Propagation delay, low to high output level <sup>(3)</sup>	$V_{icm} = 0\text{ V}$ , $f = 10\text{ kHz}$ , $CL = 50\text{ pF}$ , overdrive = 100 mV		38	60	ns
		$V_{icm} = 0\text{ V}$ , $f = 10\text{ kHz}$ , $CL = 50\text{ pF}$ , overdrive = 20 mV		48	75	
$TP_{HL}$	Propagation delay, high to low output level <sup>(4)</sup>	$V_{icm} = 0\text{ V}$ , $f = 10\text{ kHz}$ , $CL = 50\text{ pF}$ , overdrive = 100 mV		40	60	ns
		$V_{icm} = 0\text{ V}$ , $f = 10\text{ kHz}$ , $CL = 50\text{ pF}$ , overdrive = 20 mV		49	75	
$T_F$	Fall time	$f = 10\text{ kHz}$ , $CL = 50\text{ pF}$ , $RL = 10\text{ k}\Omega$ , overdrive = 100 mV		8		
$T_R$	Rise time	$f = 10\text{ kHz}$ , $CL = 50\text{ pF}$ , $RL = 10\text{ k}\Omega$ , overdrive = 100 mV		9		

1. All values over the temperature range are guaranteed through correlation and simulation. No production test is performed at the temperature range limits.
2. Maximum values include unavoidable inaccuracies of the industrial tests
3. Response time is measured at 50% of the final output value with the following conditions: inverting input voltage ( $IN-$ ) =  $V_{icm}$  and non-inverting input voltage ( $IN+$ ) moving from  $V_{icm} - 100\text{ mV}$  to  $V_{icm} + \text{overdrive}$ .
4. Response time is measured at 50% of the final output value with the following conditions: inverting input voltage ( $IN-$ ) =  $V_{icm}$  and non-inverting input voltage ( $IN+$ ) moving from  $V_{icm} + 100\text{ mV}$  to  $V_{icm} - \text{overdrive}$ .

**Table 4. Electrical characteristics at  $V_{CC+} = 3.3\text{ V}$ ,  $V_{CC-} = 0\text{ V}$ ,  $T_{amb} = 25\text{ °C}$ , and full  $V_{icm}$  range (unless otherwise specified)**

Symbol	Parameter	Test conditions <sup>(1)</sup>	Min.	Typ.	Max.	Unit
$V_{IO}$	Input offset voltage	$-40\text{ °C} < T_{amb} < 125\text{ °C}$		0.2	6	mV
					7	
$\Delta V_{IO}/\Delta T$	Input offset voltage drift	$-40\text{ °C} < T_{amb} < 125\text{ °C}$		3	20	$\mu\text{V}/\text{°C}$
$I_{IO}$	Input offset current <sup>(2)</sup>	$T_{amb}$		1	20	nA
		$-40\text{ °C} < T_{amb} < +125\text{ °C}$			100	
$I_{IB}$	Input bias current <sup>(2)</sup>	$T_{amb}$		86	160	
		$-40\text{ °C} < T_{amb} < +125\text{ °C}$			300	
$I_{CC}$	Supply current	No load, output high, $V_{icm} = 0\text{ V}$		75	90	$\mu\text{A}$
		No load, output high, $V_{icm} = 0\text{ V}$ , $-40\text{ °C} < T_{amb} < 125\text{ °C}$			120	
		No load, output low, $V_{icm} = 0\text{ V}$		86	110	
		No load, output low, $V_{icm} = 0\text{ V}$ , $-40\text{ °C} < T_{amb} < 125\text{ °C}$			125	
$I_{SC}$	Short-circuit current	Source		26		mA
		Sink		24		
$V_{OH}$	Output voltage high	$I_{source} = 1\text{ mA}$	3.20	3.25		V
		$-40\text{ °C} < T_{amb} < 125\text{ °C}$	3.10			
$V_{OL}$	Output voltage low	$I_{sink} = 1\text{ mA}$		40	80	mV
		$-40\text{ °C} < T_{amb} < 125\text{ °C}$			150	
CMRR	Common mode rejection ratio	$0 < V_{icm} < 3.3\text{ V}$		75		dB
SVR	Supply voltage rejection	$\Delta V_{CC} = 2\text{ to }5\text{ V}$	58	73		
$TP_{LH}$	Propagation delay, low to high output level <sup>(3)</sup>	$V_{icm} = 0\text{ V}$ , $f = 10\text{ kHz}$ , $CL = 50\text{ pF}$ , overdrive = 100 mV		39	65	
		$V_{icm} = 0\text{ V}$ , $f = 10\text{ kHz}$ , $CL = 50\text{ pF}$ , overdrive = 20 mV		50	85	
$TP_{HL}$	Propagation delay, high to low output level <sup>(4)</sup>	$V_{icm} = 0\text{ V}$ , $f = 10\text{ kHz}$ , $CL = 50\text{ pF}$ , overdrive = 100 mV		41	65	ns
		$V_{icm} = 0\text{ V}$ , $f = 10\text{ kHz}$ , $CL = 50\text{ pF}$ , overdrive = 20 mV		51	80	
$T_F$	Fall time	$f = 10\text{ kHz}$ , $CL = 50\text{ pF}$ , $RL = 10\text{ k}\Omega$ , overdrive = 100 mV		5		
$T_R$	Rise time	$f = 10\text{ kHz}$ , $CL = 50\text{ pF}$ , $RL = 10\text{ k}\Omega$ , overdrive = 100 mV		7		

1. All values over the temperature range are guaranteed through correlation and simulation. No production test is performed at the temperature range limits.
2. Maximum values include unavoidable inaccuracies of the industrial tests.
3. Response time is measured at 50% of the final output value with the following conditions: inverting input voltage ( $IN-$ ) =  $V_{icm}$  and non-inverting input voltage ( $IN+$ ) moving from  $V_{icm} - 100\text{ mV}$  to  $V_{icm} + \text{overdrive}$ .
4. Response time is measured at 50% of the final output value with the following conditions: Inverting input voltage ( $IN-$ ) =  $V_{icm}$  and non-inverting input voltage ( $IN+$ ) moving from  $V_{icm} + 100\text{ mV}$  to  $V_{icm} - \text{overdrive}$ .

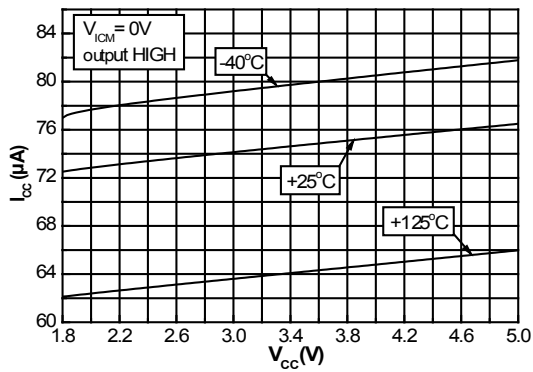
**Table 5. Electrical characteristics at  $V_{CC} = 5\text{ V}$ ,  $T_{amb} = 25\text{ °C}$ , and full  $V_{icm}$  range (unless otherwise specified)**

Symbol	Parameter	Test conditions <sup>(1)</sup>	Min.	Typ.	Max.	Unit
$V_{IO}$	Input offset voltage	-40 °C < $T_{amb}$ < 125 °C, TS3021A		0.2	6	mV
					7	
$\Delta V_{IO}/\Delta T$	Input offset voltage drift	-40 °C < $T_{amb}$ < 125 °C		3	20	$\mu\text{V}/\text{°C}$
$I_{IO}$	Input offset current <sup>(2)</sup>	$T_{amb}$		1	20	nA
		-40 °C < $T_{amb}$ < +125 °C			100	
$I_{IB}$	Input bias current <sup>(2)</sup>	$T_{amb}$		86	160	nA
		-40 °C < $T_{amb}$ < +125 °C			300	
$I_{CC}$	Supply current	No load, output high, $V_{icm} = 0\text{ V}$		77	95	$\mu\text{A}$
		No load, output high, $V_{icm} = 0\text{ V}$ , -40 °C < $T_{amb}$ < 125 °C			125	
		No load, output low, $V_{icm} = 0\text{ V}$		89	115	
		No load, output low, $V_{icm} = 0\text{ V}$ , -40 °C < $T_{amb}$ < 125 °C			135	
$I_{SC}$	Short-circuit current	Source		51		mA
		Sink		40		
$V_{OH}$	Output voltage high	$I_{source} = 4\text{ mA}$	4.80	4.84		V
		-40 °C < $T_{amb}$ < 125 °C	4.70			
$V_{OL}$	Output voltage low	$I_{sink} = 4\text{ mA}$		130	180	mV
		-40 °C < $T_{amb}$ < 125 °C			250	
CMRR	Common mode rejection ratio	$0 < V_{icm} < 5\text{ V}$		79		dB
SVR	Supply voltage rejection	$\Delta V_{CC} = 2\text{ to }5\text{ V}$	58	73		
$TP_{LH}$	Propagation delay, low to high output level <sup>(3)</sup>	$V_{icm} = 0\text{ V}$ , $f = 10\text{ kHz}$ , $CL = 50\text{ pF}$ , overdrive = 100 mV		42	75	ns
		$V_{icm} = 0\text{ V}$ , $f = 10\text{ kHz}$ , $CL = 50\text{ pF}$ , overdrive = 20 mV		54	105	
$TP_{HL}$	Propagation delay, high to low output level <sup>(4)</sup>	$V_{icm} = 0\text{ V}$ , $f = 10\text{ kHz}$ , $CL = 50\text{ pF}$ , overdrive = 100 mV		45	75	ns
		$V_{icm} = 0\text{ V}$ , $f = 10\text{ kHz}$ , $CL = 50\text{ pF}$ , overdrive = 20 mV		55	95	
$T_F$	Fall time	$f = 10\text{ kHz}$ , $CL = 50\text{ pF}$ , $RL = 10\text{ k}\Omega$ , overdrive = 100 mV		4		ns
$T_R$	Rise time	$f = 10\text{ kHz}$ , $CL = 50\text{ pF}$ , $RL = 10\text{ k}\Omega$ , overdrive = 100 mV		4		ns

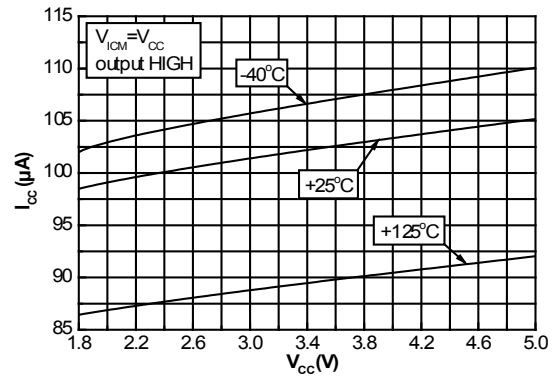
1. All values over the temperature range are guaranteed through correlation and simulation. No production test is performed at the temperature range limits.
2. Maximum values include unavoidable inaccuracies of the industrial tests.
3. Response time is measured 10%/90% of the final output value with the following conditions: inverting input voltage (IN-) =  $V_{icm}$  and non-inverting input voltage (IN+) moving from  $V_{icm} - 100\text{ mV}$  to  $V_{icm} + \text{overdrive}$ .
4. Response time is measured 10%/90% of the final output value with the following conditions: Inverting input voltage (IN-) =  $V_{icm}$  and non-inverting input voltage (IN+) moving from  $V_{icm} + 100\text{ mV}$  to  $V_{icm} - \text{overdrive}$ .

### 3 Electrical characteristic curves

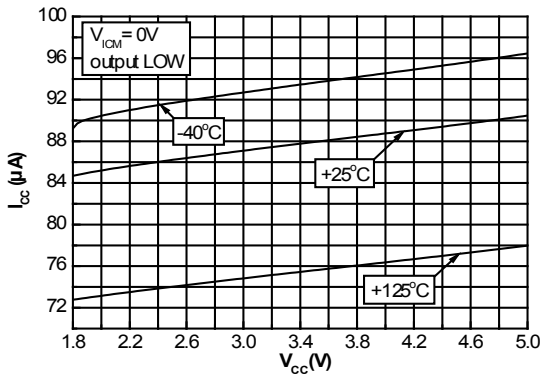
**Figure 1. Current consumption vs. supply voltage (V<sub>ICM</sub> = 0 V, output high)**



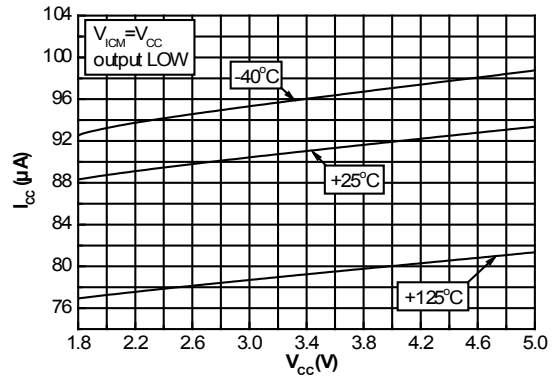
**Figure 2. Current consumption vs. supply voltage (V<sub>ICM</sub> = V<sub>CC</sub> output high)**



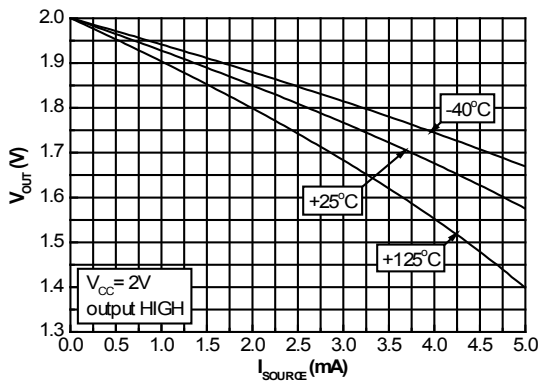
**Figure 3. Current consumption vs. supply voltage (V<sub>ICM</sub> = 0 V, output low)**



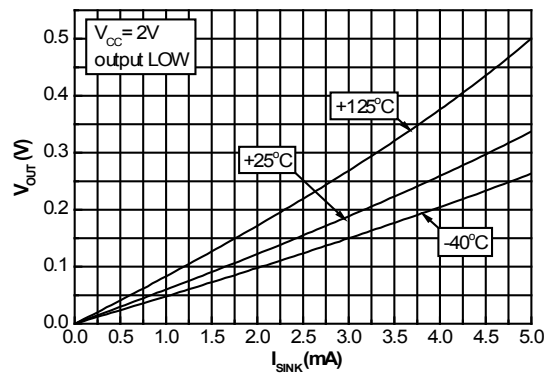
**Figure 4. Current consumption vs. supply voltage (V<sub>ICM</sub> = V<sub>CC</sub> output low)**

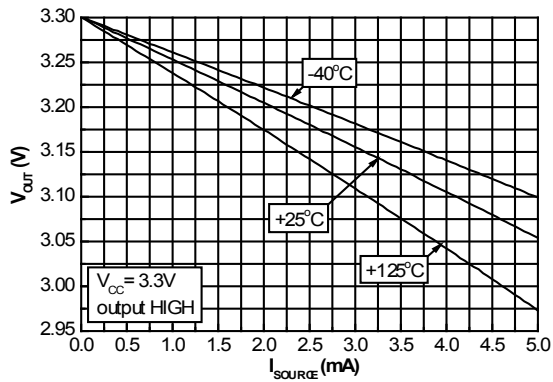
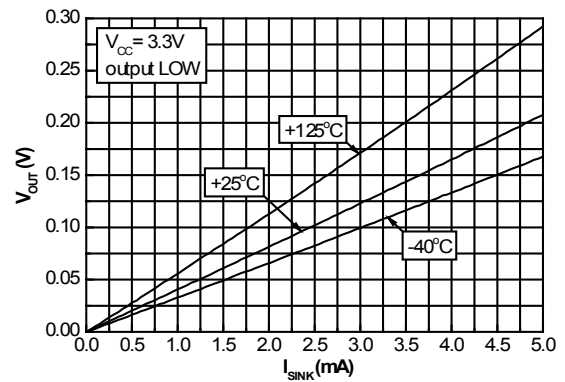
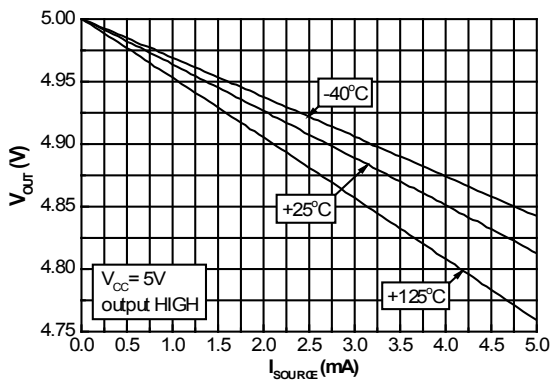
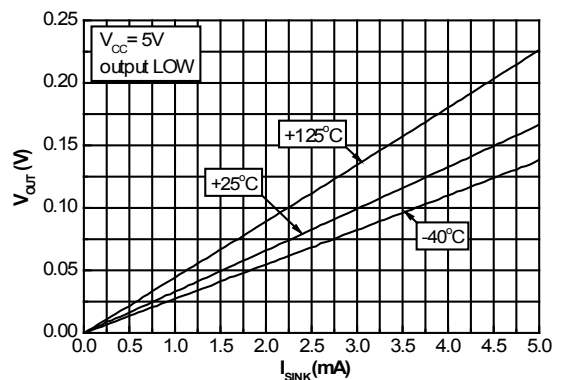
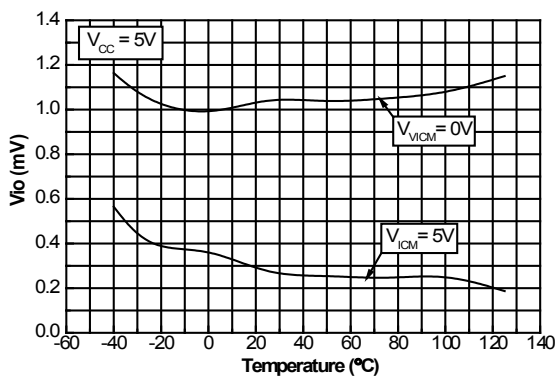
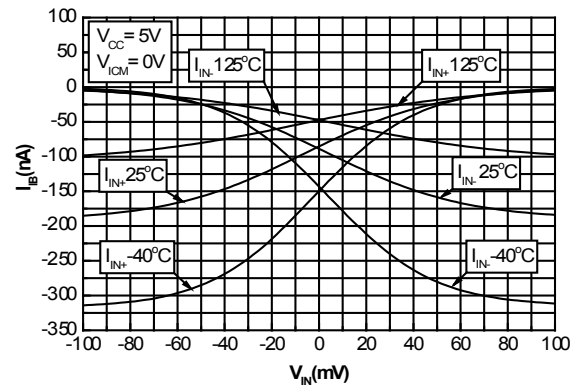


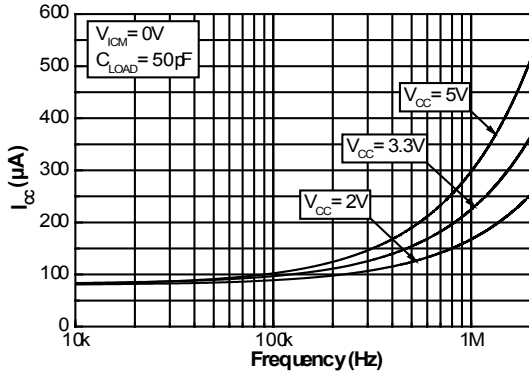
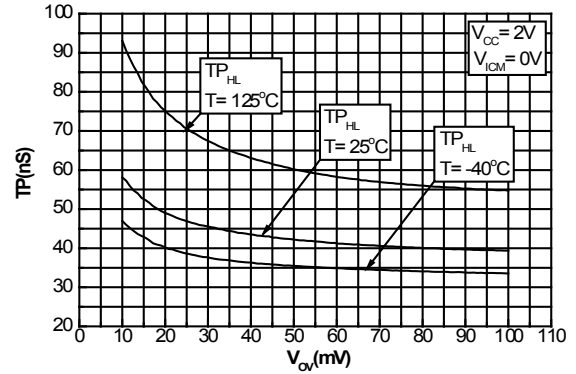
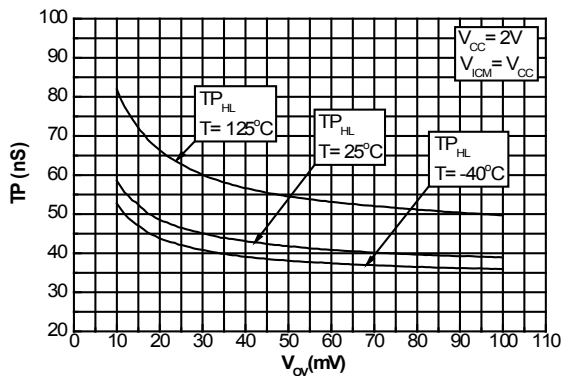
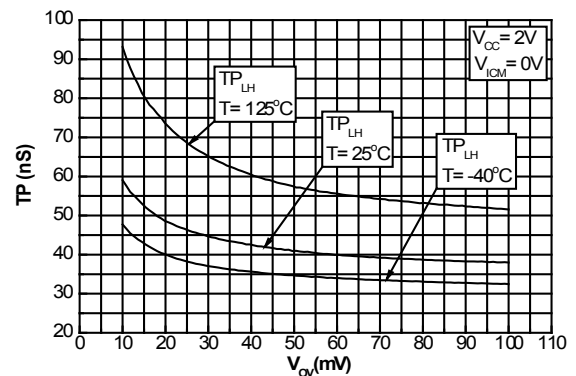
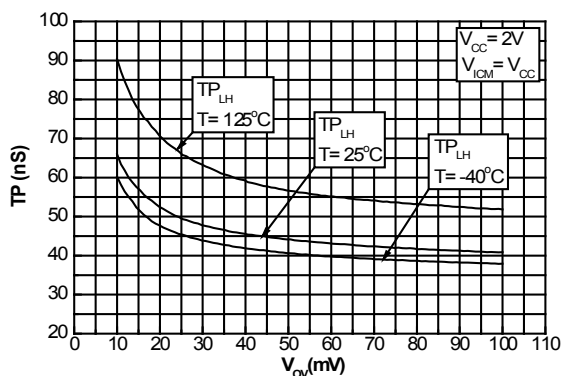
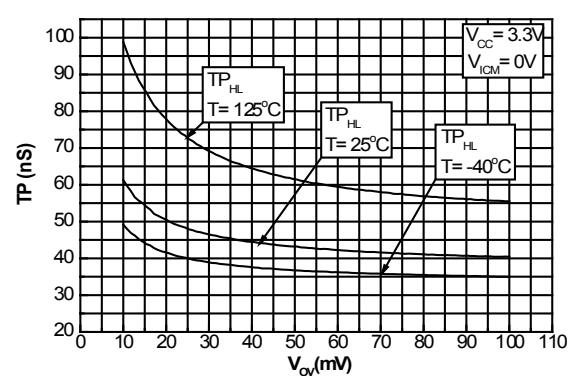
**Figure 5. Output voltage vs. source current, V<sub>CC</sub> = 2 V**



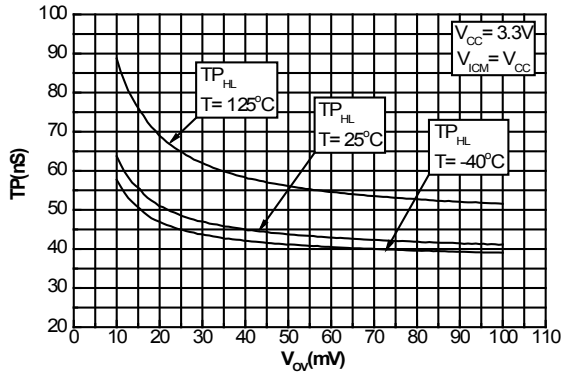
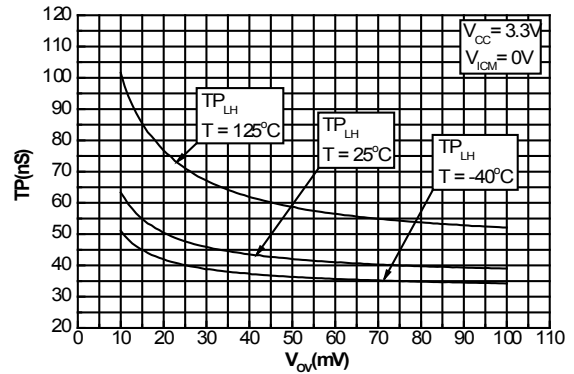
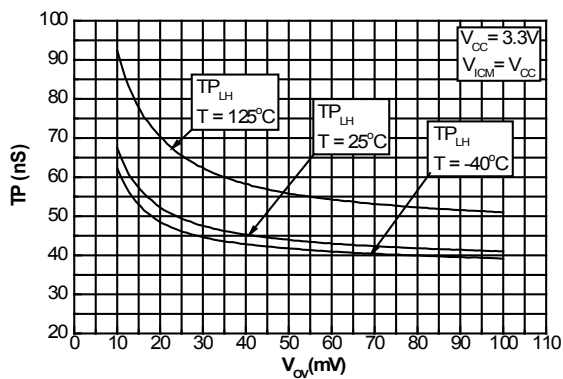
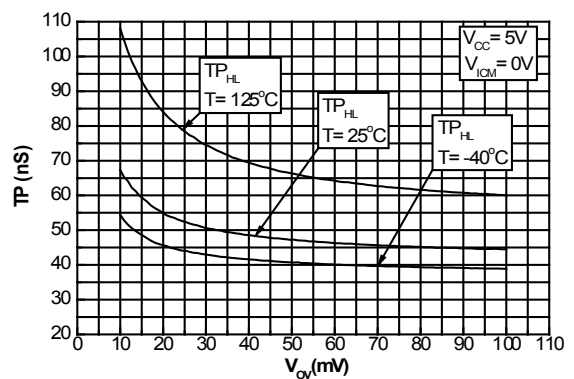
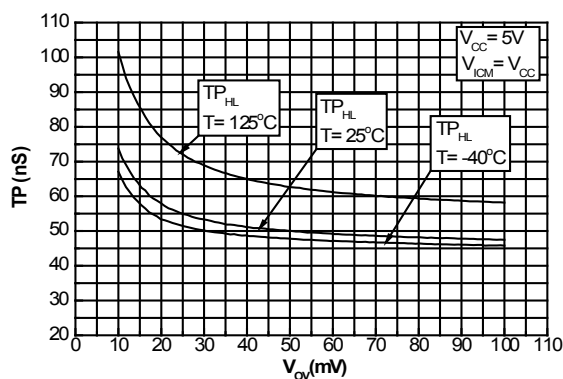
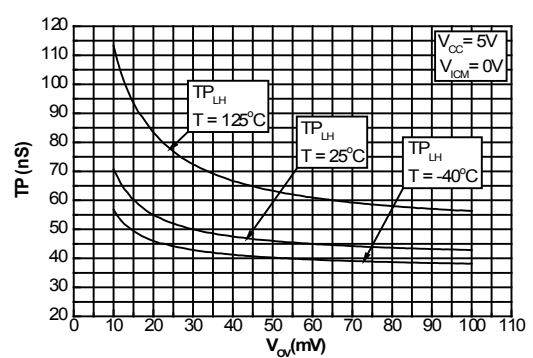
**Figure 6. Output voltage vs. sink current, V<sub>CC</sub> = 2 V**

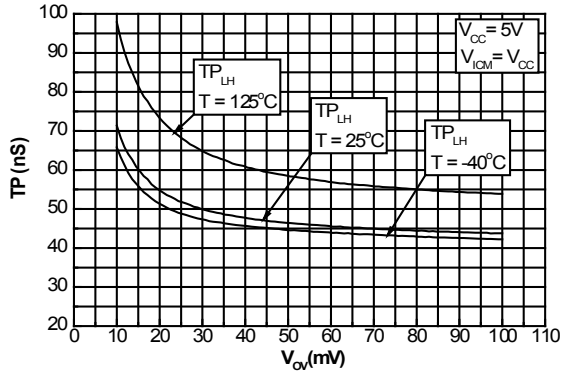
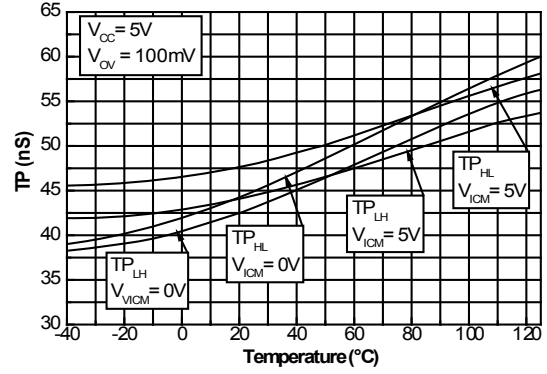
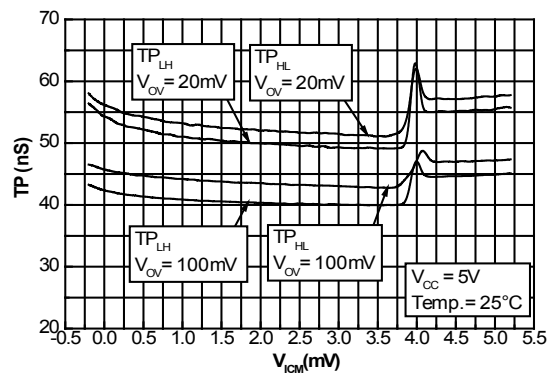


**Figure 7. Output voltage vs. source current,  $V_{CC} = 3.3\text{ V}$** 

**Figure 8. Output voltage vs. sink current,  $V_{CC} = 3.3\text{ V}$** 

**Figure 9. Output voltage vs. source current,  $V_{CC} = 5\text{ V}$** 

**Figure 10. Output voltage vs. sink current,  $V_{CC} = 5\text{ V}$** 

**Figure 11. Input offset voltage vs. temperature and common mode voltage**

**Figure 12. Input bias current vs. temperature and input voltage**


**Figure 13. Current consumption vs. commutation frequency**

**Figure 14. Propagation delay (HL) vs. overdrive at  $V_{CC} = 2V$ ,  $V_{ICM} = 0V$** 

**Figure 15. Propagation delay (HL) vs. overdrive at  $V_{CC} = 2V$ ,  $V_{ICM} = V_{CC}$** 

**Figure 16. Propagation delay (LH) vs. overdrive at  $V_{CC} = 2V$ ,  $V_{ICM} = 0V$** 

**Figure 17. Propagation delay (LH) vs. overdrive at  $V_{CC} = 2V$ ,  $V_{ICM} = V_{CC}$** 

**Figure 18. Propagation delay (HL) vs. overdrive at  $V_{CC} = 3.3V$ ,  $V_{ICM} = 0V$** 




**Figure 19. Propagation delay (HL) vs. overdrive at V<sub>CC</sub> = 3.3 V, Vicm = V<sub>CC</sub>**

**Figure 20. Propagation delay (LH) vs. overdrive at V<sub>CC</sub> = 3.3 V, Vicm = 0 V**

**Figure 21. Propagation delay (LH) vs. overdrive at V<sub>CC</sub> = 3.3 V, Vicm = V<sub>CC</sub>**

**Figure 22. Propagation delay (HL) vs. overdrive at V<sub>CC</sub> = 5 V, Vicm = 0 V**

**Figure 23. Propagation delay (HL) vs. overdrive at V<sub>CC</sub> = 5 V, Vicm = V<sub>CC</sub>**

**Figure 24. Propagation delay (LH) vs. overdrive at V<sub>CC</sub> = 5 V, Vicm = 0 V**


**Figure 25. Propagation delay (LH) vs. overdrive at  $V_{CC} = 5\text{ V}$ ,  $V_{ICM} = V_{CC}$** 

**Figure 26. Propagation delay vs. temperature,  $V_{CC} = 5\text{ V}$ , overdrive = 100 mV**

**Figure 27. Propagation delay vs. common mode voltage,  $V_{CC} = 5\text{ V}$** 


## 4 Application recommendation

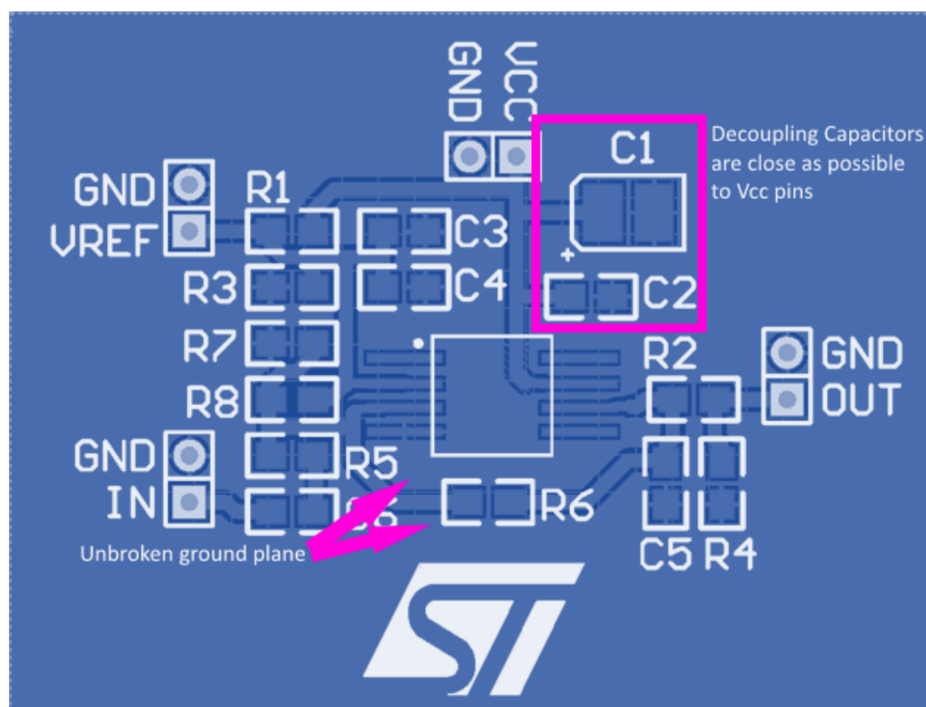
When high speed comparators are used, it is strongly recommended to place a capacitor as close as possible to the supply pins. Decoupling has two main advantages for this application: it helps to reduce electromagnetic interference and rejects the ripple that may appear on the output.

A bypass capacitor combination, composed of 100 nF in addition to 10 nF and 1 nF in parallel is recommended because it eliminates spikes on the supply line better than a single 100 nF capacitor. Each millimeter of the PCB track plays an important role. Bypass capacitors must be placed as close as possible to the comparator supply pin. The smallest value capacitor should be preferably placed closer to the supply pin.

In addition, important values of input impedance in series with parasitic PCB capacity and input comparator capacity create an additional RC filter. It generates an additional propagation delay.

For high speed signal applications, PCB must be designed with great care taking into consideration low resistive grounding, short tracks and quality SMD capacitors featuring low ESR. Bypass capacitor stores energy and provides a complementary energy tank when spikes occur on the power supply line. If the input signal frequency is far from the resonant frequency, impedance strongly increases and the capacitor loses bypassing capability. Placing different capacitors with different resonant frequencies allows a wide frequency bandwidth to be covered. It is also recommended to implement an unbroken ground plane with low inductance.

**Figure 28. High speed layout recommendation**



## **5** Package information

---

In order to meet environmental requirements, ST offers these devices in different grades of **ECOPACK®** packages, depending on their level of environmental compliance. ECOPACK® specifications, grade definitions and product status are available at: [www.st.com](http://www.st.com). ECOPACK® is an ST trademark.

## 5.1 SO-8 package information

Figure 29. SO-8 package outline

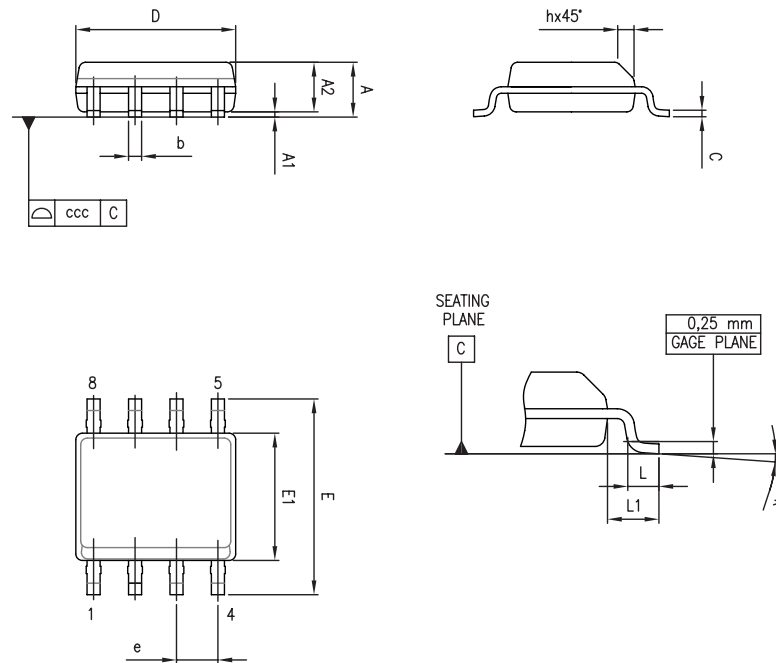
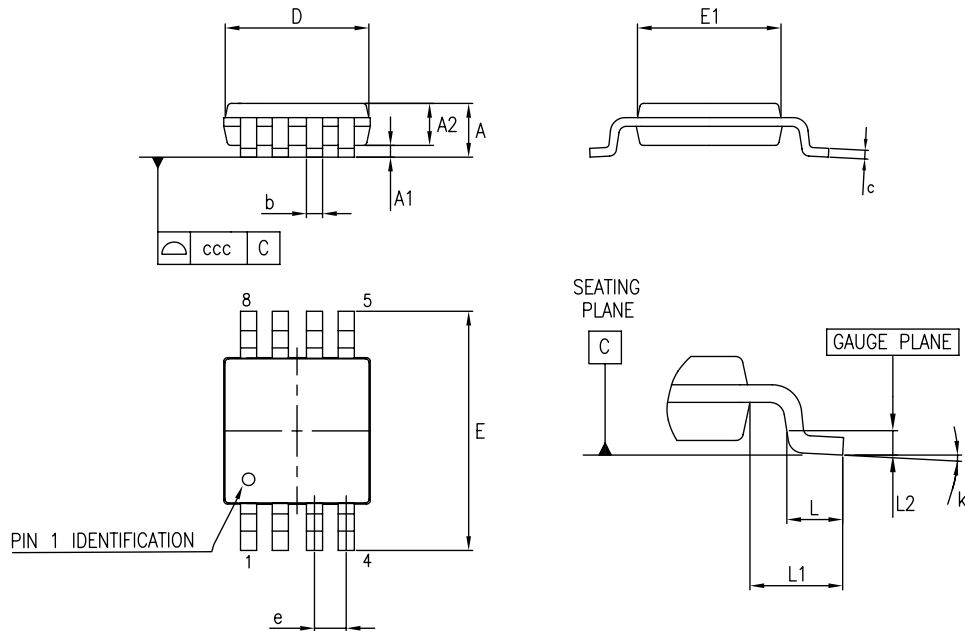


Table 6. SO-8 package mechanical data

Ref.	Dimensions					
	Millimeters			Inches		
	Min.	Typ.	Max.	Min.	Typ.	Max.
A			1.75			0.069
A1	0.10		0.25	0.04		0.010
A2	1.25			0.049		
b	0.28		0.48	0.011		0.019
c	0.17		0.23	0.007		0.010
D	4.80	4.90	5.00	0.189	0.193	0.197
E	5.80	6.00	6.20	0.228	0.236	0.244
E1	3.80	3.90	4.00	0.150	0.154	0.157
e		1.27			0.050	
h	0.25		0.50	0.010		0.020
L	0.40		1.27	0.016		0.050
L1		1.04			0.040	
k	0		8°	1°		8°
ccc			0.10			0.004

## 5.2 MiniSO8 package information

**Figure 30. MiniSO8 package outline**

**Table 7. MiniSO8 mechanical data**

Dim.	Millimeters			Inches		
	Min.	Typ.	Max.	Min.	Typ.	Max.
A			1.1			0.043
A1	0		0.15	0		0.006
A2	0.75	0.85	0.95	0.03	0.033	0.037
b	0.22		0.4	0.009		0.016
c	0.08		0.23	0.003		0.009
D	2.8	3	3.2	0.11	0.118	0.126
E	4.65	4.9	5.15	0.183	0.193	0.203
E1	2.8	3	3.1	0.11	0.118	0.122
e		0.65			0.026	
L	0.4	0.6	0.8	0.016	0.024	0.031
L1		0.95			0.037	
L2		0.25			0.01	
k	0°		8°	0°		8°
ccc			0.1			0.004

## 6 Ordering information

**Table 8. Ordering information**

Order code	Temperature range	Package	Packing	Marking
TS3022IDT	-40 to 125 °C	SO-8	Tape and reel	3022I
TS3022IST				
TS3022IYST <sup>(1)</sup>		MiniSO-8		K521
				K520

1. Qualified and characterized according to AEC Q100 and Q003 or equivalent, advanced screening according to AEC Q001 and Q 002 or equivalent.

## Revision history

**Table 9. Document revision history**

Date	Revision	Changes
29-Jan-2009	1	Initial release. The information contained in this datasheet was previously included in the TS3021-TS3022 datasheet (revision 4 dated October 2007). The single version (TS3021) and dual version (TS3022) have now been split into two separate datasheets. Refer to the TS3021 revision 5 for a complete history of changes.
25-Jun-2009	2	Modified ESD tolerances in Table 1: Absolute maximum ratings. In Table 3, Table 4 and Table 5: – modified VIO typical value and maximum limits. – modified IIB typical value. – modified ICC typical values and corrected maximum limits. – modified ISC typical values. – modified VOH and VOL typical values. – modified CMRR and SVR typical values. – modified TPHL and TPLH typical values. – modified note 3. – added note 4. Modified all curves.
07-Dec-2017	3	Updated features and applications in cover page. Updated Section 6: "Ordering information".
12-Mar-2019	4	Added new CDM parameter in <a href="#">Table 1. Absolute maximum ratings (AMR)</a> .



**IMPORTANT NOTICE – PLEASE READ CAREFULLY**

STMicroelectronics NV and its subsidiaries (“ST”) reserve the right to make changes, corrections, enhancements, modifications, and improvements to ST products and/or to this document at any time without notice. Purchasers should obtain the latest relevant information on ST products before placing orders. ST products are sold pursuant to ST’s terms and conditions of sale in place at the time of order acknowledgement.

Purchasers are solely responsible for the choice, selection, and use of ST products and ST assumes no liability for application assistance or the design of Purchasers’ products.

No license, express or implied, to any intellectual property right is granted by ST herein.

Resale of ST products with provisions different from the information set forth herein shall void any warranty granted by ST for such product.

ST and the ST logo are trademarks of ST. For additional information about ST trademarks, please refer to [www.st.com/trademarks](http://www.st.com/trademarks). All other product or service names are the property of their respective owners.

Information in this document supersedes and replaces information previously supplied in any prior versions of this document.

© 2019 STMicroelectronics – All rights reserved

Компания «Океан Электроники» предлагает заключение долгосрочных отношений при поставках импортных электронных компонентов на взаимовыгодных условиях!

Наши преимущества:

- Поставка оригинальных импортных электронных компонентов напрямую с производств Америки, Европы и Азии, а так же с крупнейших складов мира;
- Широкая линейка поставок активных и пассивных импортных электронных компонентов (более 30 млн. наименований);
- Поставка сложных, дефицитных, либо снятых с производства позиций;
- Оперативные сроки поставки под заказ (от 5 рабочих дней);
- Экспресс доставка в любую точку России;
- Помощь Конструкторского Отдела и консультации квалифицированных инженеров;
- Техническая поддержка проекта, помощь в подборе аналогов, поставка прототипов;
- Поставка электронных компонентов под контролем ВП;
- Система менеджмента качества сертифицирована по Международному стандарту ISO 9001;
- При необходимости вся продукция военного и аэрокосмического назначения проходит испытания и сертификацию в лаборатории (по согласованию с заказчиком);
- Поставка специализированных компонентов военного и аэрокосмического уровня качества (Xilinx, Altera, Analog Devices, Intersil, Interpoint, Microsemi, Actel, Aeroflex, Peregrine, VPT, Syfer, Eurofarad, Texas Instruments, MS Kennedy, Miteq, Cobham, E2V, MA-COM, Hittite, Mini-Circuits, General Dynamics и др.);

Компания «Океан Электроники» является официальным дистрибьютором и эксклюзивным представителем в России одного из крупнейших производителей разъемов военного и аэрокосмического назначения «JONHON», а так же официальным дистрибьютором и эксклюзивным представителем в России производителя высокотехнологичных и надежных решений для передачи СВЧ сигналов «FORSTAR».



## JONHON

«JONHON» (основан в 1970 г.)

Разъемы специального, военного и аэрокосмического назначения:

(Применяются в военной, авиационной, аэрокосмической, морской, железнодорожной, горно- и нефтедобывающей отраслях промышленности)

«FORSTAR» (основан в 1998 г.)

ВЧ соединители, коаксиальные кабели, кабельные сборки и микроволновые компоненты:

(Применяются в телекоммуникациях гражданского и специального назначения, в средствах связи, РЛС, а так же военной, авиационной и аэрокосмической отраслях промышленности).



Телефон: 8 (812) 309-75-97 (многоканальный)

Факс: 8 (812) 320-03-32

Электронная почта: [ocean@oceanchips.ru](mailto:ocean@oceanchips.ru)

Web: <http://oceanchips.ru/>

Адрес: 198099, г. Санкт-Петербург, ул. Калинина, д. 2, корп. 4, лит. А