

## MICRO SWITCH Premium Subminiature Basic Switches

SM Series

004959

Issue 3

Datasheet



### DESCRIPTION

The industry-defining name in snap-action switches, Honeywell MICRO SWITCH premium subminiature switches are designed for repeatability and enhanced product life. The MICRO SWITCH SM Series delivers consistent performance within a range of conditions.

The MICRO SWITCH SM Series' small size and light weight are combined with ample electrical capacity, precision operation, and extended life. Featuring high precision and repeatability, the SM Series offers gold contacts for low-energy switching and gold bifurcated contacts for maximum reliability. Bifurcated contacts provide parallel redundancy within the SM switch.

The SM switch is available for power-duty switching up to 11 A (Vac) or 1/4 HP (Vac).

### DIFFERENTIATION

- Very wide temperature range allows for years of reliable performance in the harshest of conditions
- MIL-PRF-8805 qualified listings
- Operating forces as low as 0,06 N [6 g] and differential travel as low as 0,025 mm [0.001 in] delivers consistent, precise switch characteristics

### FEATURES

- Industry-leading mechanical life of up to 10,000,000 operations
- Selection of actuation, electrical termination, and operating characteristics along with high-temperature construction options
- Wide temperature range of -54°C to 204°C [-65°F to 400°F]
- MIL-PRF-8805 qualified listings in a lightweight, small package
- FAA-PMA approvals for commercial aircraft
- Choice of silver or gold-plated, or gold bifurcated contacts to handle a variety of electrical load requirements
- UL/CSA, cUL, ENEC, and CE approvals

### VALUE TO CUSTOMERS

- Industry-leading life cycle rating reduces the need to replace switches over life in an OEM platform – reducing total system cost
- Low operating forces
- Mil-qualified listings
- Life of up to 10,000,000 cycles

### POTENTIAL APPLICATIONS

- Precision switch assemblies for commercial aircraft to monitor doors for “closed” and “locked” position
- Landing gear monitor
- Precision switch assemblies for commercial cockpit applications for pushbuttons, toggle, or joystick assemblies
- Precision switch assemblies in military applications
- Assemblies for industrial pressure switches and temperature switches
- Power generation fuel level (gas and oil)

### PORTFOLIO

The SM Series of premium subminiature basic switches are a part of a strong offering of submins including SX Series (premium) and ZM, ZM1, ZD, ZX, and ZW Series (standard) switches.

# MICRO SWITCH Premium Subminiature Basic Switches, SM Series

**Table 1. Specifications**

Characteristic	Parameter
Differentiator	low operating force to 2 oz. max; power load switching capability to 11 A; motor load handling capacity to 1/4 HP (Vac)
Ampere rating	0.1 A to 11 A
Circuitry	SPDT
Operating force	0.04 oz to 2 oz
Termination	quick connect, solder, pcb
Actuator	pin plunger, straight lever, roller lever, simulated roller lever, paddle lever
Voltage	115 Vac, 125 Vac, 250 Vac, 30 Vdc
Agency approvals	UL, CE, CSA, ENEC, MIL-PRF-8805, FAA-PMA
Agency file information	CE: 61058-1; UL: E12252; CSA: LR41372
Operating temperature	-54°C to 121°C [-65°F to 250°F]; select catalog listings 204°C [400°F]
Contacts	silver, gold plated, bifurcated gold
Housing	phenolic
Sealing	sealed plunger on 411SM Series, other SM Series not weather sealed
Mechanical life	up to 10,000,000 operations for 11SM listings up to 80,000 operations for 1SM/41SM listings up to 1,000,000 operations for gold bifurcated contact
Size	12,7 mm H x 6,35 mm W x 20,3 mm L [0.5 in H x 0.25 in W x 0.8 in L]

## Electrical data and UL codes

**Table 2. UL Electrical Ratings**

Code	Circuitry	Electrical data and UL codes
J	SPDT	5 A res., 3 A ind., (sea level), 5 A res., 2.5 A ind., (50,000 feet), 28 Vdc. UL rating: 5 A, 250 Vac
K	SPDT	UL rating: 5 A, 125 or 250 Vac
M	SPDT	UL rating: 11 A and 1/4 hp, 125 or 250 Vac
N	SPDT	1 A res., 0.5 A ind., 30 Vdc. UL rating: 1 A, 125 Vac
P	SPDT	1 A res., 30 Vdc. UL rating: .1 A, 125 Vac
R	SPDT	5 A res., 3 A ind., 2.4 A lamp load (sea level), 5 A res., 2.5 A ind., 2.4 A lamp load, (50,000 feet), 28 Vdc. 5 A res., 5 A ind., 1.5 A lamp load, 115 Vac. 60 Hz (sea level)
S	SPDT	UL rating: 4 A, 250 Vac

# MICRO SWITCH Premium Subminiature Basic Switches, SM Series

O.F. • Operating force  
 R.F. • Release force  
 P.T. • Pretravel  
 O.T. • Overtravel  
 D.T. • Differential travel  
 O.P. • Operating position

Table 3. MICRO SWITCH SM Series Order Guide • Pin Plunger

Catalog Listing	Recommended For	Electrical Data and UL Codes	O.F. N [oz]	R.F. min. N [oz]	P.T. max. mm [in]	O.T. min. mm [in]	D.T. mm [in]	O.P. * mm [in]
<b>11SM1077-T</b>	Gold-plated contacts	0.1 A <b>P</b>	0,83 to 1,39 [3 to 5]	0,28 [1]	0,51 [0.020]	0,13 [0.005]	0,1 [0.004]	8,38 [0.330]
<b>12SM604-T</b>	Bifurcated gold contacts, reduced rating	0.1 A <b>P</b>	0,83 to 1,39 [3 to 5]	0,28 [1]	0,51 [0.020]	0,076 [0.003]	0,1 [0.004]	8,38 [0.330]
<b>11SM23-T</b>	Gold-plated contacts	1 A <b>N</b>	0,83 to 1,39 [3 to 5]	0,28 [1]	0,51 [0.020]	0,13 [0.005]	0,1 [0.004]	8,38 [0.330]
<b>12SM4-T</b>	Enhanced reliability (bifurcated gold contacts)	1 A <b>N</b>	0,83 to 1,39 [3 to 5]	0,28 [1]	0,51 [0.020]	0,076 [0.003]	0,1 [0.004]	8,38 [0.330]
<b>11SM701-T</b>	Lower force	4 A <b>S</b>	0,56 [2]	0,14 [0.5]	0,51 [0.020]	0,13 [0.005]	0,051 [0.002]	8,38 [0.330]
<b>11SM1-T</b>	General purpose	5 A <b>J</b>	0,83 to 1,39 [3 to 5]	0,28 [1]	0,51 [0.020]	0,13 [0.005]	0,1 [0.004]	8,38 [0.330]
<b>11SM3-T</b>	Operating temps to 121°C [250°F]	5 A <b>J</b>	0,83 to 1,39 [3 to 5]	0,28 [1]	0,51 [0.020]	0,13 [0.005]	0,1 [0.004]	8,38 [0.330]
<b>11SM244-T</b>	Operating temps to 204°C [400°F] for 100 hours	5 A	0,83 to 1,39 [3 to 5]	0,28 [1]	0,51 [0.020]	0,13 [0.005]	0,1 [0.004]	8,38 [0.330]
<b>11SM401-T</b>	Less differential travel	5 A <b>K</b>	0,97 [3.5] max.	0,28 [1]	0,51 [0.020]	0,13 [0.005]	0,025 [0.001]	8,38 [0.330]
<b>21SM284-T2 (MS25085-2)</b>	MIL-PRF-8805 applications	5 A <b>R</b>	0,83 to 1,39 [3 to 5]	0,28 [1]	0,76 [0.030]	0,13 [0.005]	0,1 [0.004]	8,38 [0.330]
<b>21SM284 (MS25085-1)</b>	MIL-PRF-8805 applications, solder terminals	5 A <b>R</b>	0,83 to 1,39 [3 to 5]	0,28 [1]	0,76 [0.030]	0,13 [0.005]	0,1 [0.004]	8,38 [0.330]
<b>22SM1-T</b>	Enhanced stability under varying humidity	5 A <b>J</b>	0,83 to 1,39 [3 to 5]	0,28 [1]	0,51 [0.020]	0,13 [0.005]	0,1 [0.004]	8,38 [0.330]
<b>41SM1-T</b>	Up to 11 A, 1/4 HP (ac)	11 A <b>M</b>	0,83 to 1,39 [3 to 5]	0,28 [1]	0,76 [0.030]	0,13 [0.005]	0,1 [0.004]	8,38 [0.330]
<b>411SM1</b>	Sealed plunger construction	5 A <b>K</b>	0,83 to 2,09 [3 to 7.5]	0,28 [1]	0,51 [0.020]	0,13 [0.005]	0,1 [0.004]	8,38 [0.330]
<b>411SM23</b>	Sealed plunger construction, gold contacts	1 A <b>N</b>	0,83 to 2,09 [3 to 7.5]	0,28 [1]	0,51 [0.020]	0,13 [0.005]	0,1 [0.004]	8,38 [0.330]











\* except where stated ±0,38 mm [±0.015 in]

# MICRO SWITCH Premium Subminiature Basic Switches, SM Series

O.F. • Operating force  
 R.F. • Release force  
 P.T. • Pretravel  
 O.T. • Overtravel  
 D.T. • Differential travel  
 O.P. • Operating position

Table 4. MICRO SWITCH SM Series Order Guide • Integral Lever

	Catalog Listing	Recommended For	Electrical Data and UL Codes	O.F. N [oz]	R.F. min. N [oz]	P.T. max. mm [in]	O.T. min. mm [in]	D.T. mm [in]	O.P. * mm [in]
	<b>311SM1-T</b>	7,24 mm [0.285 in] straight lever	5 A <b>J</b>	0,39 [1.4]	0,07 [0.25]	2,16 [0.085]	0,51 [0.020]	0,48 [0.019]	8,64 mm ±1,5 mm [0.34 in ±0.060 in]
	<b>311SM23-T</b>	7,24 mm [0.285 in] straight lever, gold contacts	1 A <b>N</b>	0,39 [1.4]	0,07 [0.25]	2,16 [0.085]	0,51 [0.020]	0,48 [0.019]	8,64 mm ±1,5 mm [0.34 in ±0.060 in]
	<b>311SM701-T</b>	7,24 mm [0.285 in] straight lever, lower force	4 A <b>S</b>	0,16 [0.57]	0,03 [0.11]	2,16 [0.085]	0,51 [0.020]	0,36 [0.014]	8,64 mm ±1,5 mm [0.34 in ±0.060 in]
	<b>311SM2-T</b>	14,35 mm [0.565 in] straight lever	5 A <b>J</b>	0,31 [1.1]	0,05 [0.18]	3,05 [0.12]	0,66 [0.026]	0,69 [0.027]	8,51 mm ±2 mm [0.335 in ±0.08 in]
	<b>311SM43-T</b>	14,35 mm [0.565 in] straight lever, gold contacts	1 A <b>N</b>	0,31 [1.1]	0,05 [0.18]	3,05 [0.12]	0,66 [0.026]	0,69 [0.027]	8,51 mm ±2 mm [0.335 in ±0.08 in]
	<b>311SM702-T</b>	14,35 mm [0.565 in] straight lever, lower force	4 A <b>S</b>	0,11 [0.4]	0,02 [0.07]	3,05 [0.12]	0,66 [0.026]	0,38 [0.015]	8,51 mm ±2 mm [0.335 in ±0.08 in]
	<b>311SM3-T</b>	44,8 mm [1.765 in] straight lever	5 A <b>J</b>	0,15 [0.53]	0,02 [0.07]	7,87 [0.31]	1,45 [0.057]	2,8 [0.11]	7,11 mm ±4,3 mm [0.28 in ±0.17 in]
	<b>311SM17-H58</b>	44,8 mm [1.765 in] straight lever, gold contacts	1 A <b>N</b>	0,15 [0.53]	0,02 [0.07]	7,87 [0.31]	1,45 [0.057]	2,8 [0.11]	7,11 mm ±4,3 mm [0.28 in ±0.17 in]
	<b>311SM703-T</b>	44,8 mm [1.765 in] straight lever, lower force	4 A <b>S</b>	0,06 [0.2]	0,01 [0.04]	7,87 [0.31]	1,45 [0.057]	1,78 [0.07]	7,11 mm ±4,3 mm [0.28 in ±0.17 in]
	<b>311SM4-T</b>	6,38 mm [0.251 in] simulated roller lever	5 A <b>J</b>	0,39 [1.4]	0,07 [0.25]	2,16 [0.085]	0,46 [0.018]	0,48 [0.019]	11,7 mm ±1,5 mm [0.46 in ±0.06 in]
	<b>311SM25-T</b>	6,38 mm [0.251 in] simulated roller lever, gold contacts	1 A <b>N</b>	0,39 [1.4]	0,07 [0.25]	2,16 [0.085]	0,46 [0.018]	0,48 [0.019]	11,7 mm ±1,5 mm [0.46 in ±0.06 in]
	<b>311SM704-T</b>	6,38 mm [0.251 in] simulated roller lever, lower force	4 A <b>S</b>	0,16 [0.57]	0,03 [0.11]	2,16 [0.085]	0,46 [0.018]	0,33 [0.013]	11,7 mm ±1,5 mm [0.46 in ±0.06 in]
	<b>311SM5-T</b>	13,6 mm [0.535 in] simulated roller lever	5 A <b>J</b>	0,31 [1.1]	0,05 [0.18]	3,05 [0.12]	0,66 [0.026]	0,69 [0.027]	11,56 mm ±2 mm [0.455 in ±0.08 in]
	<b>311SM705-T</b>	13,6 mm [0.535 in] simulated roller lever, lower force	4 A <b>S</b>	0,11 [0.4]	0,02 [0.07]	3,05 [0.12]	0,66 [0.026]	0,38 [0.015]	11,56 mm ±2 mm [0.455 in ±0.08 in]
	<b>311SM6-T</b>	6,38 mm [0.251 in] roller lever	5 A <b>J</b>	0,39 [1.4]	0,07 [0.25]	2,16 [0.085]	0,46 [0.018]	0,48 [0.019]	14,2 mm ±1,5 mm [0.56 in ±0.06 in]
	<b>311SM68-T</b>	6,38 mm [0.251 in] roller lever, gold contacts	1 A <b>N</b>	0,39 [1.4]	0,07 [0.25]	2,16 [0.085]	0,46 [0.018]	0,48 [0.019]	14,2 mm ±1,5 mm [0.56 in ±0.06 in]
	<b>311SM706-T</b>	6,38 mm [0.251 in] roller lever, lower force	4 A <b>S</b>	0,16 [0.57]	0,03 [0.11]	2,16 [0.085]	0,46 [0.018]	0,33 [0.013]	14,2 mm ±1,5 mm [0.56 in ±0.06 in]
	<b>311SM7-T</b>	13,6 mm [0.535 in] roller lever	5 A <b>J</b>	0,31 [1.1]	0,05 [0.18]	3,05 [0.12]	0,66 [0.026]	0,69 [0.027]	14,1 mm ±2 mm [0.555 in ±0.08 in]
	<b>111SM1-T</b>	Leaf actuator	5 A <b>J</b>	1,95 [7]	0,56 [2]	5,54 [0.218]	0,76 [0.03]	0,76 [0.03]	8,89 mm ±0,76 mm [0.35 in ±0.03 in]
	<b>111SM17-T</b>	Leaf actuator gold contacts	1 A <b>N</b>	1,95 [7]	0,56 [2]	5,54 [0.218]	0,76 [0.03]	0,76 [0.03]	8,89 mm ±0,76 mm [0.35 in ±0.03 in]
	<b>111SM2-T</b>	Flexible leaf with roller	5 A <b>J</b>	1,95 [7]	0,56 [2]	5,56 [0.219]	0,76 [0.03]	0,64 [0.025]	14,3 mm ±0,76 mm [0.562 in ±0.03 in]
	<b>111SM23-T</b>	Flexible leaf with roller, gold contacts	1 A <b>N</b>	1,95 [7]	0,56 [2]	5,56 [0.219]	0,76 [0.03]	0,64 [0.025]	14,3 mm ±0,76 mm [0.562 in ±0.03 in]

## MICRO SWITCH Premium Subminiature Basic Switches, SM Series

Table 5. Numeric Designations for MICRO SWITCH SM Series/Order Guide

Prefix	Description	Suffix	Description
<b>1SM</b>	Standard pin plunger construction, up to 80,000 operations	<b>23</b>	Gold contacts
<b>11SM</b>	Long-life pin plunger construction, up to 10,000,000 operations	<b>400</b>	Low differential travel series
<b>12SM</b>	Gold bifurcated contacts	<b>500</b>	Reverse terminal designation
<b>21SM</b>	Same as 1SM (formerly had DAP material)	<b>700</b>	Low force series
<b>22SM</b>	Same as 11SM (formerly had DAP material)	<b>1000</b>	Gold alloy
<b>23SM</b>	Same as 12SM (formerly had DAP material)		
<b>41SM</b>	11 A construction (11SM construction)		
<b>101SM</b>	1SM with an integral leaf actuator		
<b>111SM</b>	11SM with an integral spring leaf		
<b>112SM</b>	12SM with an integral spring leaf		
<b>122SM</b>	22SM with an integral spring leaf		
<b>151SM</b>	51SM with an integral spring leaf		
<b>301SM</b>	1SM with an integral rigid lever		
<b>302SM</b>	1SM with an integral roller lever		
<b>311SM</b>	Integral rigid lever		
<b>321SM</b>	21SM with an integral rigid lever		
<b>322SM</b>	22SM with an integral rigid lever		
<b>401SM</b>	Dust/splash resistant 1SM		
<b>411SM</b>	Dust/splash resistant 11SM		
<b>412SM</b>	Dust/splash resistant 12SM		

# MICRO SWITCH Premium Subminiature Basic Switches, SM Series

Table 6. SM Series • Standard Actuator Options, Screw Terminals, and Dimensions (mm/in)

Pin plunger, T terminals	Pin plunger, Solder terminals
Integral leaf lever	Integral roller lever
Integral levers	

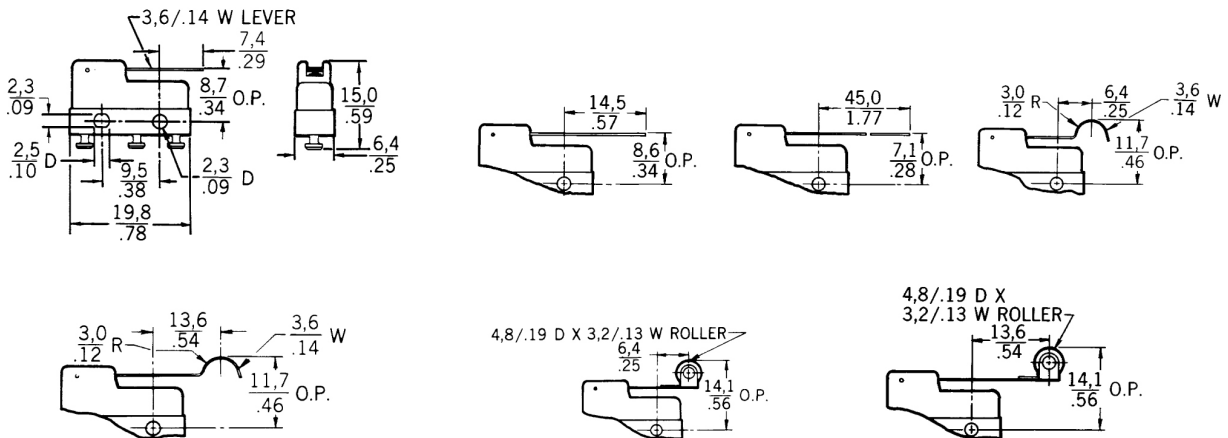

NOTE: The two mounting holes accept pins or screws of 2,21 mm (0.087 in) maximum diameter

## MICRO SWITCH SM SERIES AVAILABLE TERMINALS

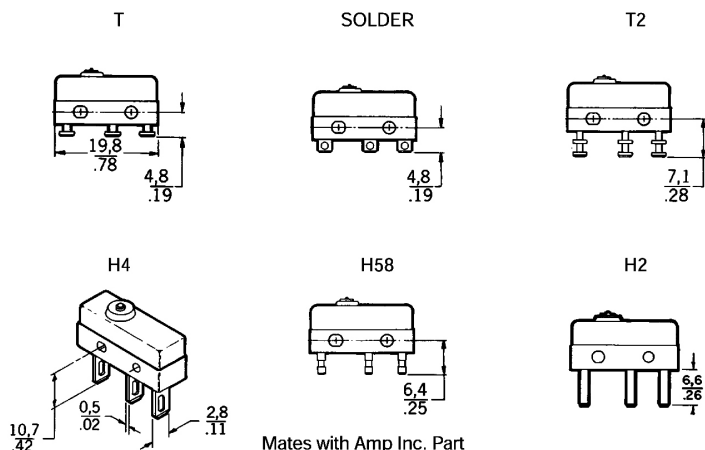









Mounting torque:  
0,26 Nm [2.3 in-lb] max.

Mates with Amp Inc. Part No. 640024-1 Std.

# MICRO SWITCH Premium Subminiature Basic Switches, SM Series

## MICRO SWITCH JS SERIES AUXILIARY ACTUATORS FOR THE MICRO SWITCH SM SERIES SWITCHES (stainless steel actuator and hardware)

		Description	Actuator Length	Operating Force max.	Release Force min.	Pretravel max.	Overtravel min.	Differential Travel max.	Operating Point	Free Position max.
JS-2		Straight leaf	16,8 mm [0.66 in]	2,78 N [10 oz]	0,56 N [2 oz]	1,98 mm [0.078 in]	0,38 mm [0.015 in]	0,38 mm [0.015 in]	8,89 mm ±0,38 mm [0.350 in ±0.015 in]	11,3 mm [0.445 in]
JS-5		Roller leaf (bronze roller)	15 mm [0.59 in]	2,78 N [10 oz]	0,83 N [3 oz]	1,98 mm [0.078 in]	0,38 mm [0.015 in]	0,38 mm [0.015 in]	14,2 mm ±0,38 mm [0.580 in ±0.015 in]	16,9 mm [0.665 in]
JS-7		Formed leaf (simulated roller)	14,7 mm [0.58 in]	2,78 N [10 oz]	0,56 N [2 oz]	2,39 mm [0.094 in]	0,79 mm [0.031 in]	0,38 mm [0.015 in]	9,65 mm ±0,38 mm [0.380 in ±0.015 in]	12,7 mm [0.475 in]
JS-220		Straight lever	26,2 mm [1.03 in]*	0,28 N [1 oz]	0,04 N [0.14 oz]	3,18 mm [0.125 in] approx.	0,76 mm [0.030 in]	0,76 mm [0.030 in]	10,3 mm [0.406 in] approx.	–
JS-246		Roller lever (steel roller)	25,4 mm [1.00 in]*	0,28 N [1 oz]	0,04 N [0.14 oz]	3,18 mm [0.125 in] approx.	0,76 mm [0.030 in]	0,76 mm [0.030 in]	14,3 mm [0.562 in] approx.	–
JS-221		Formed lever (simulated roller)	25,4 mm [1.00 in]*	0,28 N [1 oz]	0,04 N [0.14 oz]	3,18 mm [0.125 in] approx.	0,76 mm [0.030 in]	0,76 mm [0.030 in]	11,6 mm [0.455 in] approx.	–
JS-33**Δ		Tandem leaf	5,3 mm [0.21 in]	5,00 N [18 oz]	2,78 N [10 oz]	2,36 mm [0.093 in]	0,15 mm [0.006 in]	0,38 mm [0.015 in]	8,89 mm ±0,38 mm [0.350 in ±0.015 in]	10,5 mm [0.415 in]
JS-31**Δ		Tandem leaf (bronze roller)	4,3 mm [0.17 in]	11,1 N [40 oz]	4,45 N [16 oz]	2,36 mm [0.093 in]	0,13 mm [0.005 in]	0,38 mm [0.015 in]	14,5 mm ±0,38 mm [0.570 in ±0.015 in]	16,1 mm [0.635 in]

\*\* Travel characteristics on tandem actuators vary with actual basic switch characteristics

NOTE: Above actuators should be used below 300°F

\* "A" measurement is from pivot point of lever to the point indicated on drawing

Δ Plated steel machine screws

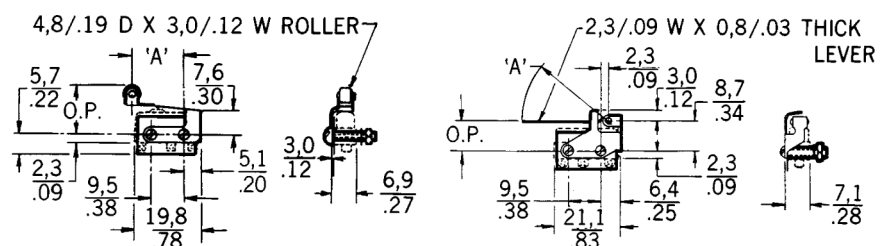

## ADDITIONAL MATERIALS

The following associated literature is available at [sensing.honeywell.com](http://sensing.honeywell.com):

- Product installation instructions
- Product range guide
- Aerospace range guide
- Applying basic switches
- Low energy switching guide
- Product application-specific information
  - Application Note: Central Vacuum System
  - Application Note: Electronic Taping Machine
  - Application Note: Sensors and Switches in Sanitary Valves
  - Application Note: Sensors and Switches in Oil Rig Applications
- Application Note: Sensors and Switches for Potential Medical Applications

### Find out more

Honeywell serves its customers through a worldwide network of sales offices and distributors. For application assistance, current specifications, pricing or name of the nearest Authorized Distributor, contact your local sales office.

To learn more about Honeywell's sensing and switching products,

call **+1-815-235-6847** or

**1-800-537-6945**,

visit **[sensing.honeywell.com](http://sensing.honeywell.com)**,

or e-mail inquiries to

**[info.sc@honeywell.com](mailto:info.sc@honeywell.com)**

## Honeywell Sensing and Internet of Things

9680 Old Bailes Road

Fort Mill, SC 29707

[honeywell.com](http://honeywell.com)

### **WARNING** **PERSONAL INJURY**

DO NOT USE these products as safety or emergency stop devices or in any other application where failure of the product could result in personal injury.

**Failure to comply with these instructions could result in death or serious injury.**

### **WARNING** **MISUSE OF DOCUMENTATION**

- The information presented in this product sheet is for reference only. Do not use this document as a product installation guide.
- Complete installation, operation, and maintenance information is provided in the instructions supplied with each product.

**Failure to comply with these instructions could result in death or serious injury.**

### Warranty/Remedy

Honeywell warrants goods of its manufacture as being free of defective materials and faulty workmanship during the applicable warranty period. Honeywell's standard product warranty applies unless agreed to otherwise by Honeywell in writing; please refer to your order acknowledgement or consult your local sales office for specific warranty details. If warranted goods are returned to Honeywell during the period of coverage, Honeywell will repair or replace, at its option, without charge those items that Honeywell, in its sole discretion, finds defective. **The foregoing is buyer's sole remedy and is in lieu of all other warranties, expressed or implied, including those of merchantability and fitness for a particular purpose. In no event shall Honeywell be liable for consequential, special, or indirect damages.**

While Honeywell may provide application assistance personally, through our literature and the Honeywell web site, it is buyer's sole responsibility to determine the suitability of the product in the application.

Specifications may change without notice. The information we supply is believed to be accurate and reliable as of this writing. However, Honeywell assumes no responsibility for its use.

# Honeywell



Компания «Океан Электроники» предлагает заключение долгосрочных отношений при поставках импортных электронных компонентов на взаимовыгодных условиях!

Наши преимущества:

- Поставка оригинальных импортных электронных компонентов напрямую с производств Америки, Европы и Азии, а так же с крупнейших складов мира;
- Широкая линейка поставок активных и пассивных импортных электронных компонентов (более 30 млн. наименований);
- Поставка сложных, дефицитных, либо снятых с производства позиций;
- Оперативные сроки поставки под заказ (от 5 рабочих дней);
- Экспресс доставка в любую точку России;
- Помощь Конструкторского Отдела и консультации квалифицированных инженеров;
- Техническая поддержка проекта, помощь в подборе аналогов, поставка прототипов;
- Поставка электронных компонентов под контролем ВП;
- Система менеджмента качества сертифицирована по Международному стандарту ISO 9001;
- При необходимости вся продукция военного и аэрокосмического назначения проходит испытания и сертификацию в лаборатории (по согласованию с заказчиком);
- Поставка специализированных компонентов военного и аэрокосмического уровня качества (Xilinx, Altera, Analog Devices, Intersil, Interpoint, Microsemi, Actel, Aeroflex, Peregrine, VPT, Syfer, Eurofarad, Texas Instruments, MS Kennedy, Miteq, Cobham, E2V, MA-COM, Hittite, Mini-Circuits, General Dynamics и др.);

Компания «Океан Электроники» является официальным дистрибьютором и эксклюзивным представителем в России одного из крупнейших производителей разъемов военного и аэрокосмического назначения «JONHON», а так же официальным дистрибьютором и эксклюзивным представителем в России производителя высокотехнологичных и надежных решений для передачи СВЧ сигналов «FORSTAR».



## JONHON

«JONHON» (основан в 1970 г.)

Разъемы специального, военного и аэрокосмического назначения:

(Применяются в военной, авиационной, аэрокосмической, морской, железнодорожной, горно- и нефтедобывающей отраслях промышленности)

«FORSTAR» (основан в 1998 г.)

ВЧ соединители, коаксиальные кабели, кабельные сборки и микроволновые компоненты:

(Применяются в телекоммуникациях гражданского и специального назначения, в средствах связи, РЛС, а так же военной, авиационной и аэрокосмической отраслях промышленности).



Телефон: 8 (812) 309-75-97 (многоканальный)

Факс: 8 (812) 320-03-32

Электронная почта: [ocean@oceanchips.ru](mailto:ocean@oceanchips.ru)

Web: <http://oceanchips.ru/>

Адрес: 198099, г. Санкт-Петербург, ул. Калинина, д. 2, корп. 4, лит. А