PWM Step-up DC/DC Converter

R1210N××1× Series

APPLICATION MANUAL

R1210N××1× Series

OUTLINE

The R1210N××1× Series are PWM step-up DC/DC Converter, with high accuracy, low supply current by CMOS process.

Each of the R1210N××1× Series consists of an oscillator, a PWM circuit, a reference voltage unit, an error amplifier, phase compensation circuit, resistors for voltage detection, a chip enable circuit. Further, includes a controller against drastic load transient, a control transistor with low ON-Resistance, 'Lx switch', and a protection circuit for Lx switch and an output voltage detector. R1210N××1A Series contain further a circuit for changeover oscillator frequency each. A low ripple, high efficiency step-up DC/DC converter can be composed of this IC with only three external components, or an inductor, a diode and a capacitor.

The R1210N Series can detect drastic change of output voltage with a circuit controller. The load transient response is improved compared with current model, furthermore the R1210N××1A Series have another function, that is, when the load current is small, oscillator frequency is decreased by a circuit for switching oscillator frequency from TYP. 100kHz to 35kHz, therefore, supply current is reduced.

The built-in chip enable circuit can make the standby mode with ultra low quiescent current.

Since the package for these ICs is small SOT-23-5, high density mounting of the ICs on board is possible.

FEATURES

- External Components Only an inductor, a diode, and a capacitor
- Standby Current TYP. 0μA
- Low Temperature-Drift Coefficient of Output Voltage..... TYP. ±100ppm/°C
- Output Voltage Stepwise Setting with a step of 0.1V in the range of
2.2V to 6.0V (××1C/D)
2.2V to 3.5V (××1A)
- Two choices of Basic Oscillator Frequency 100kHz (××1A/C), 180kHz (××1D)
- Small Package SOT-23-5 (Mini-mold)
- High Efficiency TYP. 88%
(V_{IN} =Set Output Voltage×0.6 [V], I_{OUT} =10mA)
- Low Ripple, Low Noise
- Built-in a driver transistor with low on-resistance
- Start-up Voltage MAX. 0.9V
- Basic Frequency change-over circuit (only for ××1A type)..... from TYP. 100kHz to 35kHz

APPLICATIONS

- Power source for battery-powered equipment.
- Power source for portable communication appliances, cameras, VCRs
- Power source for appliances of which require higher voltage than battery voltage.

BLOCK DIAGRAM

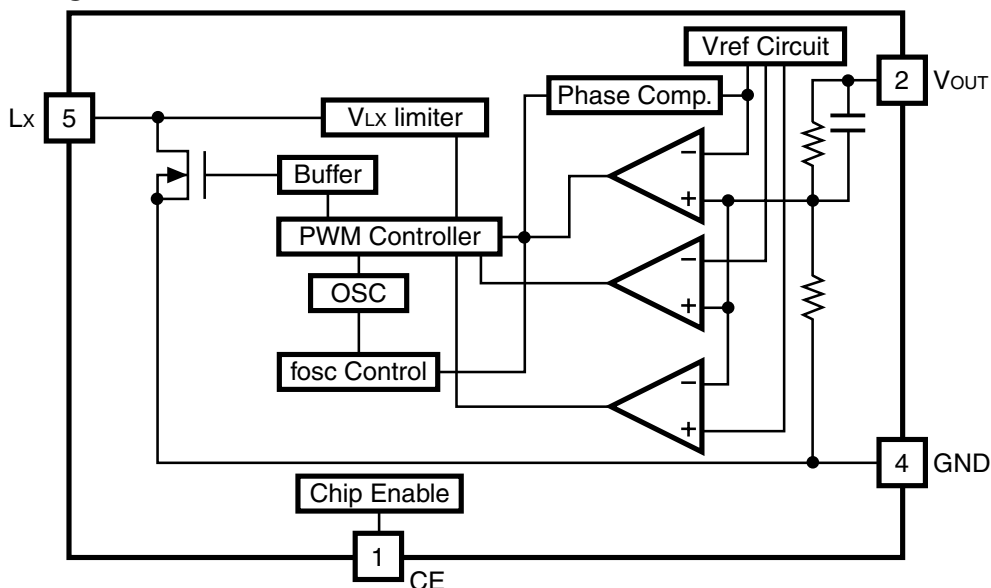

SELECTION GUIDE

In the R1210N Series, the output voltage, the oscillator frequency, the optional function, and the taping type for the ICs can be selected at the user's request.

The selection can be made by designating the part number as shown below ;

R1210Nxx1x-xx
 ↑ ↑ ↑
 a b c

| Code | Contents |
|------|--|
| a | Setting Output Voltage (V _{OUT}) : Stepwise setting with a step of 0.1V in the range of 2.2V to 6.0V (for xx1C/D version) or 2.2V to 3.5V (for xx1A version) is possible. |
| b | Designation of Oscillator Frequency A : 100kHz with a Frequency Change-over circuit C : 100kHz without a Frequency Change-over circuit D : 180kHz without a Frequency Change-over circuit |
| c | Designation of Taping Type; Ex. :TR, TL (refer to Taping Specification) "TR" is prescribed as a standard. |

PIN CONFIGURATION



PIN DESCRIPTION

| Pin No. | Symbol | Description |
|---------|------------------|-----------------------------------|
| 1 | CE | Chip Enable Pin |
| 2 | V _{OUT} | Pin for Monitoring Output Voltage |
| 3 | NC | No Connection |
| 4 | GND | Ground Pin |
| 5 | L _X | Switching Pin (Nch Open Drain) |

ABSOLUTE MAXIMUM RATINGS

| Symbol | Item | Rating | Unit |
|------------------|-------------------------------------|----------|------|
| V _{OUT} | V _{OUT} Pin Output Voltage | 9.0 | V |
| V _{LX} | L _X Pin Output Voltage | 9.0 | V |
| V _{CE} | CE Pin Input Voltage | 9.0 | V |
| I _{LX} | L _X Pin Output Current | 400 | mA |
| P _D | Power Dissipation | 250 | mW |
| T _{opt} | Operating Temperature Range | -40~+85 | °C |
| T _{stg} | Storage Temperature Range | -55~+125 | °C |

ELECTRICAL CHARACTERISTICS

• R1210Nxx1x

(T_{opt}=25°C)

| Symbol | Item | Conditions | MIN. | TYP. | MAX. | Unit |
|--|---|--|--------|------|--------|----------------|
| V _{OUT} | Output Voltage | V _{IN} =V _{SET} ×0.6, I _{OUT} =1mA | ×0.975 | | ×1.025 | V |
| V _{IN} | Maximum Input Voltage | | | | 8 | V |
| ΔV _{OUT} / ΔT _{opt} | Step-up Output Voltage Temperature Coefficient | -40°C ≤ T _{opt} ≤ 85°C | | ±100 | | ppm/°C |
| V _{start} | Start-up Voltage | V _{IN} =0V→2V V _{OUT} :1.8kΩ pull-down | | | 0.9 | V |
| ΔV _{start} / ΔT _{opt} | Start-up Voltage Temperature Coefficient | -40°C ≤ T _{opt} ≤ 85°C | | -3.2 | | mV/°C |
| V _{hold} | Hold-on Voltage | V _{IN} =2V→0V, I _{OUT} =1mA | 0.7 | | | V (××1A/C) |
| | | | 0.9 | | | V (××1D) |
| I _{DD1} | Supply Current1 | 2.2V ≤ V _{SET} ≤ 2.5V V _{OUT} = V _{SET} × 0.96 | | 30 | 55 | μA (××1A/C) |
| | | | | 50 | 80 | μA (××1D) |
| | | 2.6V ≤ V _{SET} ≤ 3.0V V _{OUT} = V _{SET} × 0.96 | | 35 | 60 | μA (××1A/C) |
| | | | | 60 | 90 | μA (××1D) |
| | | 3.1V ≤ V _{SET} ≤ 3.5V V _{OUT} = V _{SET} × 0.96 | | 40 | 70 | μA (××1A/C) |
| | | | | 70 | 100 | μA (××1D) |
| | | 3.6V ≤ V _{SET} ≤ 4.0V V _{OUT} = V _{SET} × 0.96 | | 45 | 80 | μA (××1C) |
| | | | | 80 | 110 | μA (××1D) |
| | | 4.1V ≤ V _{SET} ≤ 4.5V V _{OUT} = V _{SET} × 0.96 | | 50 | 90 | μA (××1C) |
| | | | | 90 | 120 | μA (××1D) |

| Symbol | Item | Conditions | MIN. | TYP. | MAX. | Unit |
|--|--|---|------|--------------|------|--------------------|
| I _{DD1} | Supply Current1 | 4.6V ≤ V _{SET} ≤ 5.0V V _{OUT} = V _{SET} × 0.96 | | 70 | 100 | μA (××1C) |
| | | | | 100 | 130 | μA (××1D) |
| | | 5.1V ≤ V _{SET} ≤ 5.5V V _{OUT} = V _{SET} × 0.96 | | 80 | 110 | μA (××1C) |
| | | | | 110 | 150 | μA (××1D) |
| 5.6V ≤ V _{SET} ≤ 6.0V V _{OUT} = V _{SET} × 0.96 | | 90 | 120 | μA (××1C) | | |
| | | 130 | 170 | μA (××1D) | | |
| I _{DD2} | Supply Current2 | V _{OUT} = V _{CE} = V _{SET} + 0.5V | | 10 | 17 | μA (××1A/C) |
| | | | | 15 | 24 | μA (××1D) |
| Istandby | Standby Current | V _{OUT} = 6V, V _{CE} = 0V | | | 0.5 | μA |
| I _{Lleak} | Lx Leakage Current | V _{OUT} = V _{LX} = 8V | | | 0.5 | μA |
| fosc | Maximum Oscillator Frequency | V _{OUT} = V _{CE} = V _{SET} × 0.96 | 80 | 100 | 120 | KHz (××1A/C) |
| | | | 144 | 180 | 216 | KHz (××1D) |
| Δfosc/ ΔT _{opt} | Oscillator Frequency Temperature Coefficient | -40°C ≤ T _{opt} ≤ 85°C | | 0.5 | | kHz/°C (××1A/C) |
| | | | | 0.6 | | kHz/°C (××1D) |
| Maxdty | Oscillator Maximum Duty Cycle | V _{OUT} = V _{CE} = V _{SET} × 0.96, (V _{LX} “L” Side) | 70 | 85 | 97 | % |
| V _{LXlim} | V _{LX} Limit Voltage | V _{OUT} = V _{CE} = V _{SET} × 0.96, (V _{LX} “L” Side) | 0.4 | 0.6 | 0.8 | V |
| V _{CEH} | CE “H” Input Voltage | V _{OUT} = V _{SET} × 0.96 | 0.9 | | | V |
| V _{CEL} | CE “L” Input Voltage | V _{OUT} = V _{SET} × 0.96 | | | 0.3 | V |
| I _{CEH} | CE “H” Input Current | V _{OUT} = V _{CE} = 6.5V | -0.1 | 0 | 0.1 | μA |
| I _{CEL} | CE “L” Input Current | V _{IN} = 6.5V, V _{CE} = 0V | -0.1 | 0 | 0.1 | μA |

| Symbol | Item | Conditions | MIN. | TYP. | MAX. | Unit |
|-----------------|----------------------------------|---|------|------|------|------|
| I _{LX} | L _x Switching Current | 2.2V ≤ V _{SET} ≤ 2.4V V _{LX} = 0.4V | 70 | | | mA |
| | | 2.5V ≤ V _{SET} ≤ 2.9V V _{LX} = 0.4V | 85 | | | mA |
| | | 3.0V ≤ V _{SET} ≤ 3.4V V _{LX} = 0.4V | 100 | | | mA |
| | | 3.5V ≤ V _{SET} ≤ 3.9V V _{LX} = 0.4V | 120 | | | mA |
| | | 4.0V ≤ V _{SET} ≤ 4.4V V _{LX} = 0.4V | 140 | | | mA |
| | | 4.5V ≤ V _{SET} ≤ 4.9V V _{LX} = 0.4V | 150 | | | mA |
| | | 5.0V ≤ V _{SET} ≤ 5.4V V _{LX} = 0.4V | 170 | | | mA |
| | | 5.5V ≤ V _{SET} ≤ 6.0V V _{LX} = 0.4V | 190 | | | mA |
| fosc2 | Change-over frequency | V _{IN} = V _{SET} × 0.6, I _{OUT} = 0.5mA (only for xx1A) | 10 | 35 | 70 | KHz |

*Note: V_{SET} means setting Output Voltage.

TEST CIRCUITS

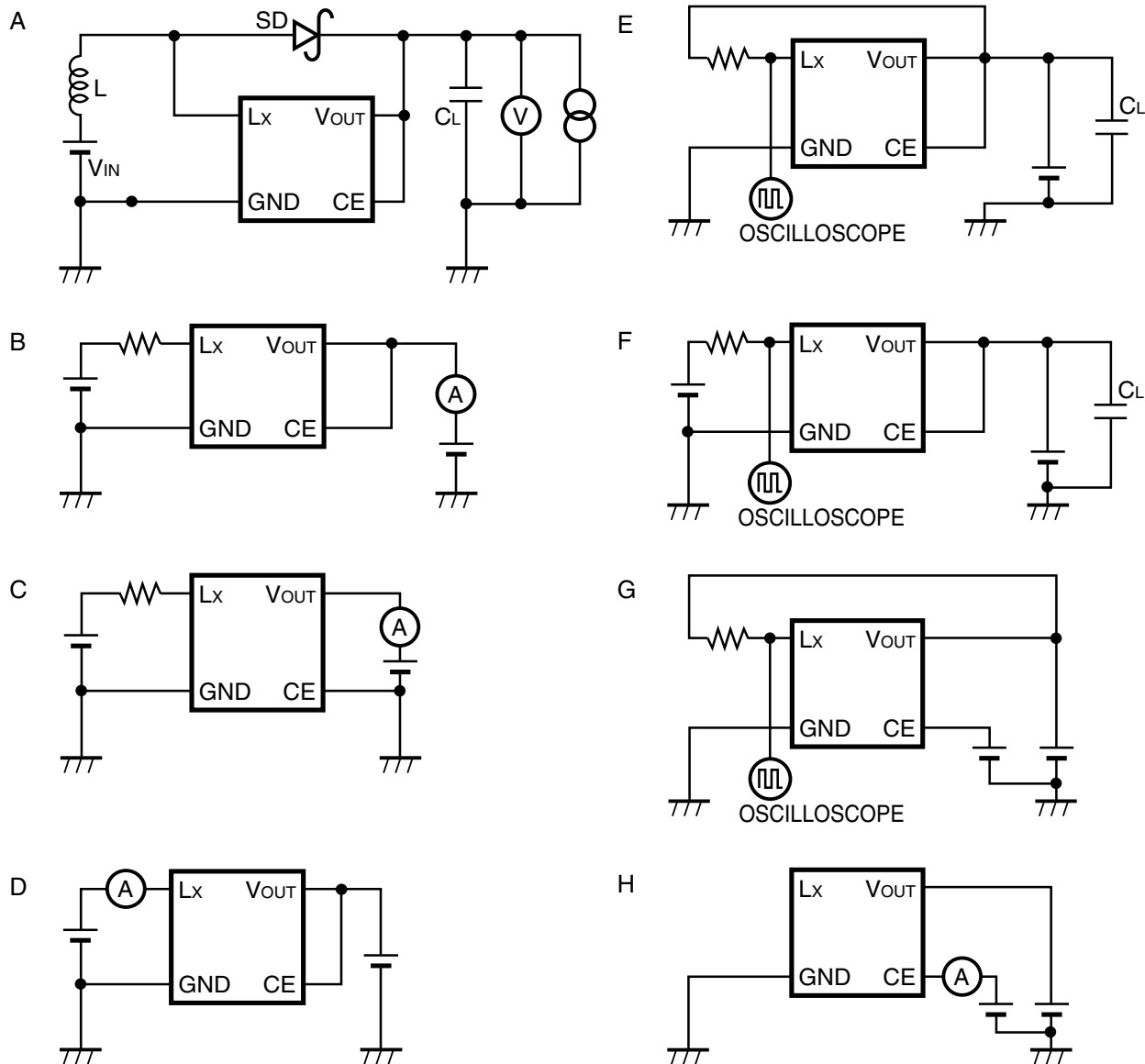

L: 100 μ H CD54 (Sumida Electric Co, LTD)

SD: MA721 (Matsushita Electronics Corporation, Schottky Type)

CL: 22 μ F \times 2 (Tantalum Type)

TYPICAL CHARACTERISTICS

1) Output Voltage vs. Output Current

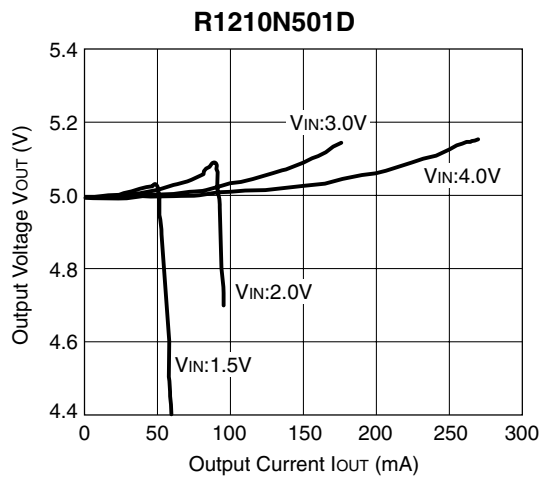
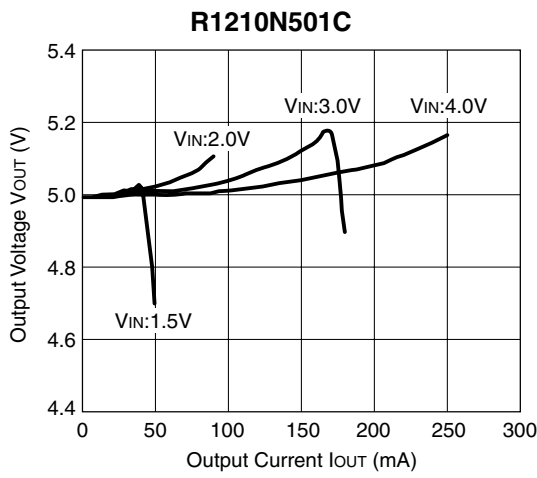
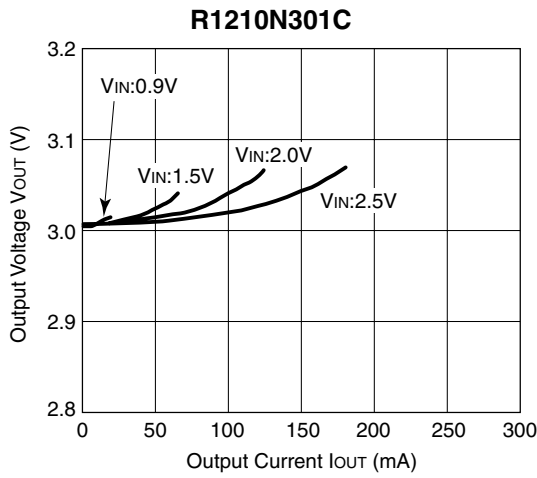

2) Efficiency vs. Output Current

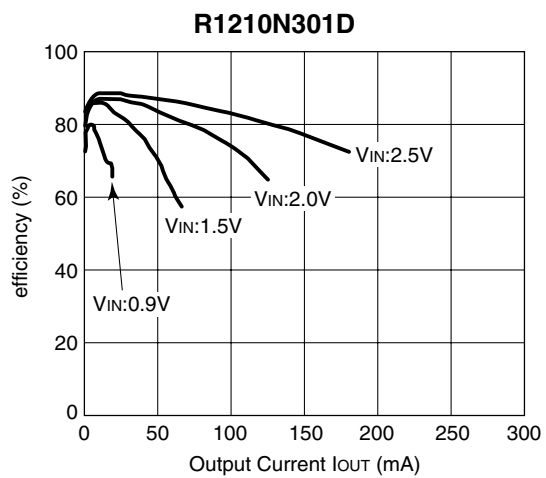
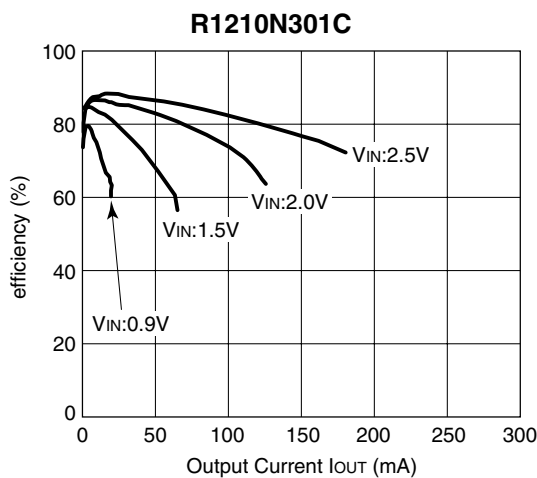

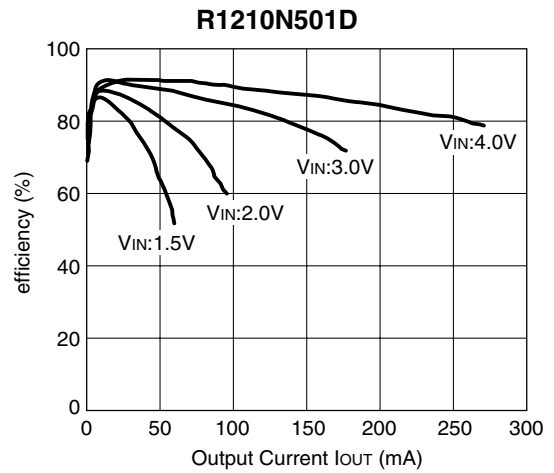
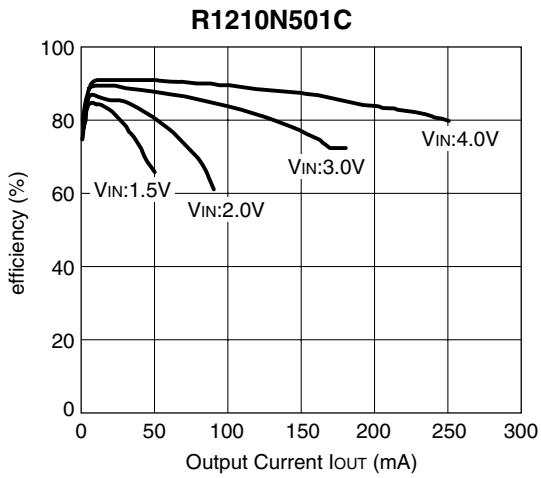

3) R1210Nxx1A/C Efficiency

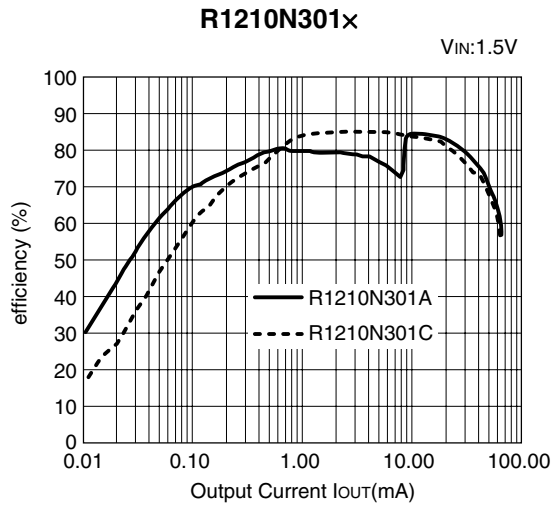

4) Ripple Voltage vs. Output Current

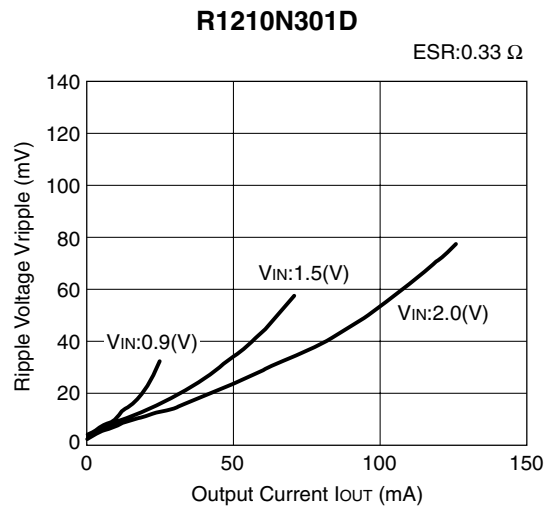
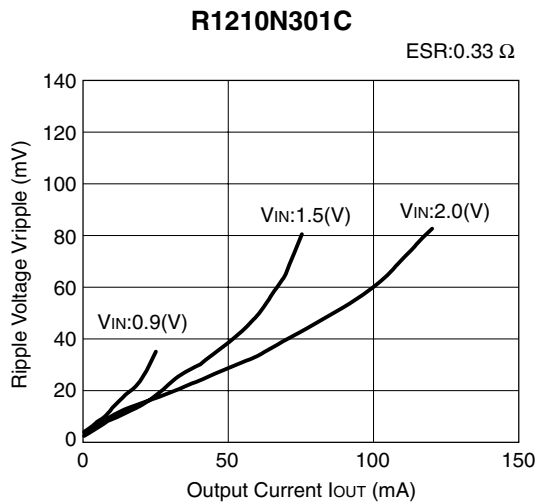

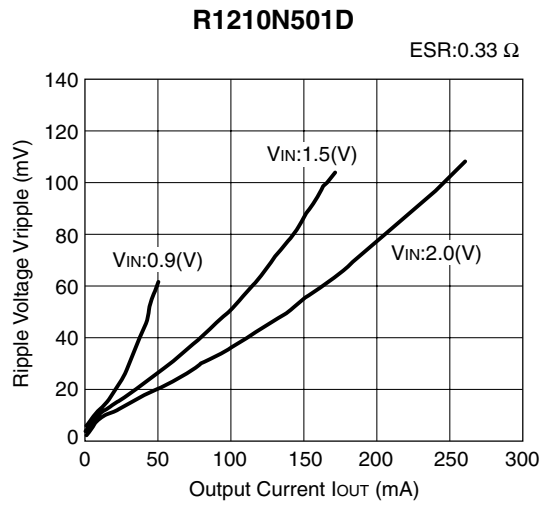

5) Start-up Voltage/ Hold-on Voltage vs. Output Current (Topt=25°C)

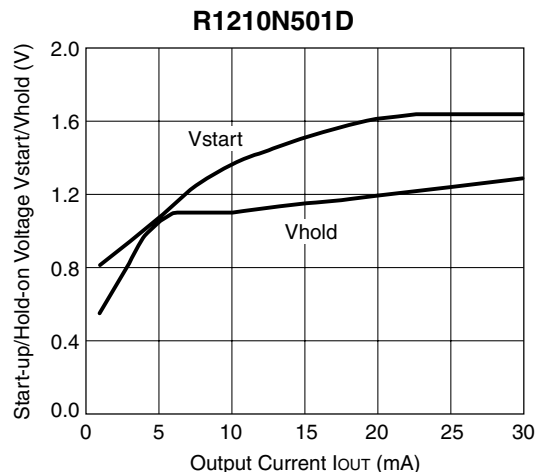
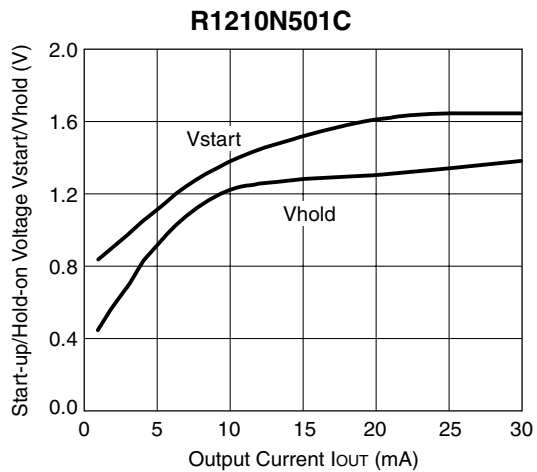
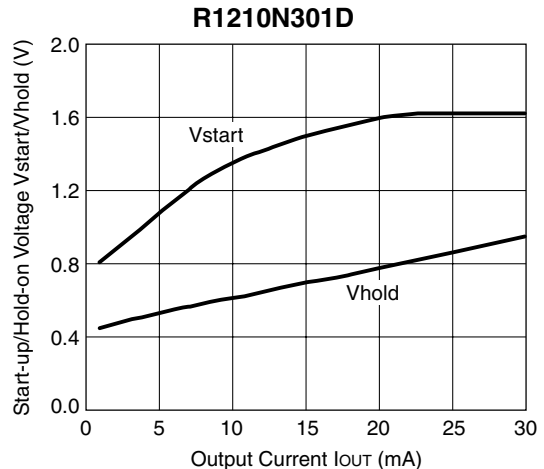

6) Output Voltage vs. Temperature

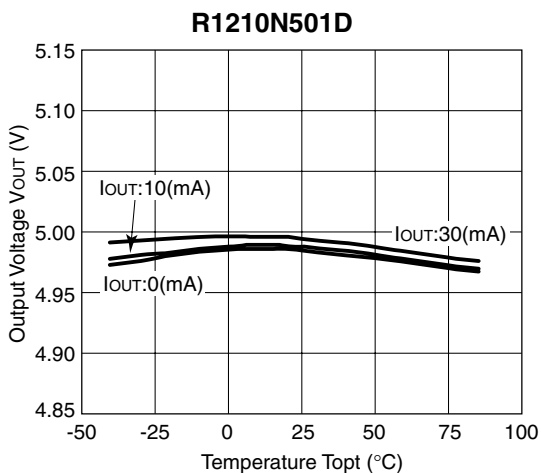
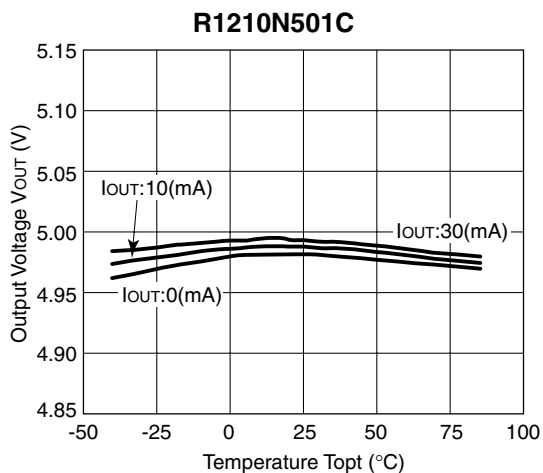
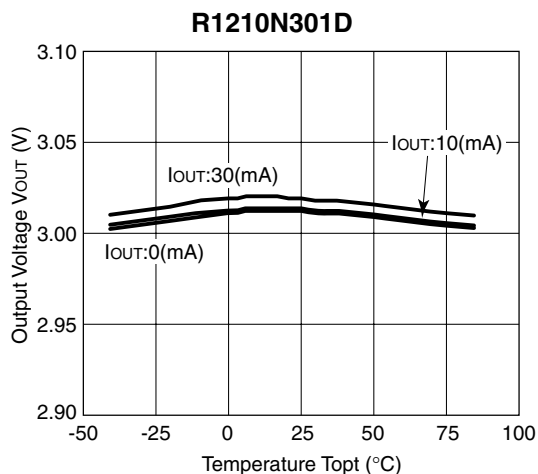

7) Supply Current 1 vs. Temperature

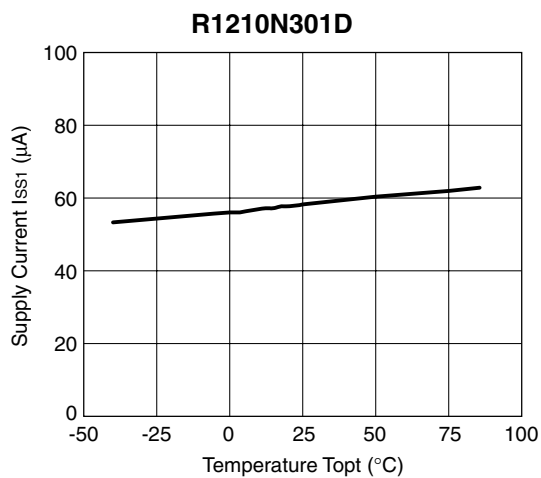
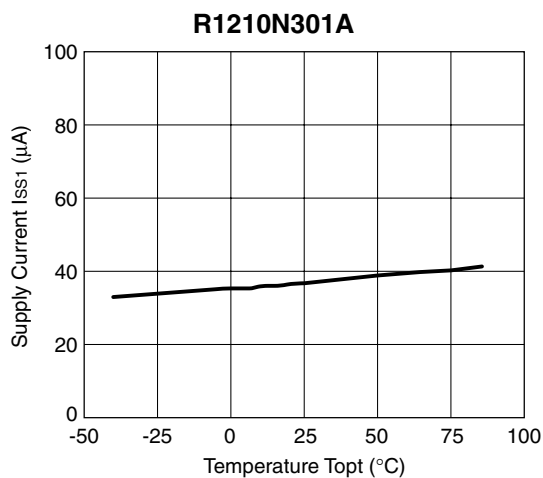

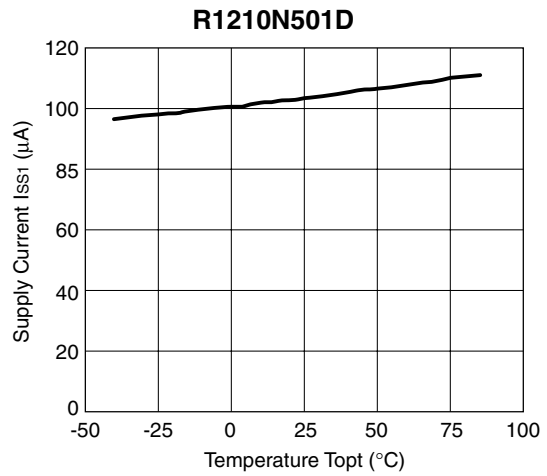
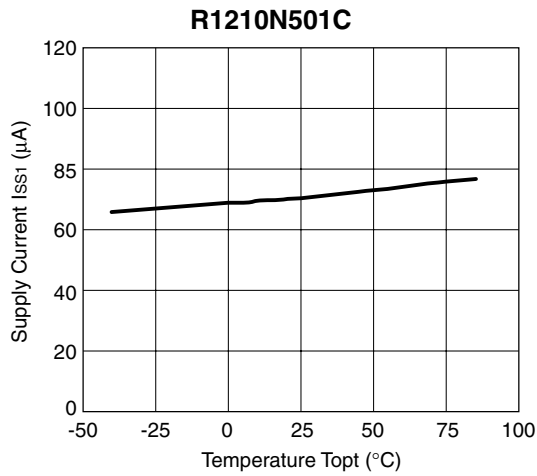

8) Supply Current2 vs. Temperature

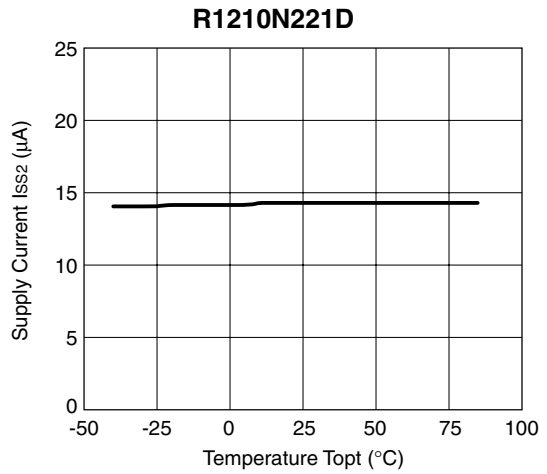
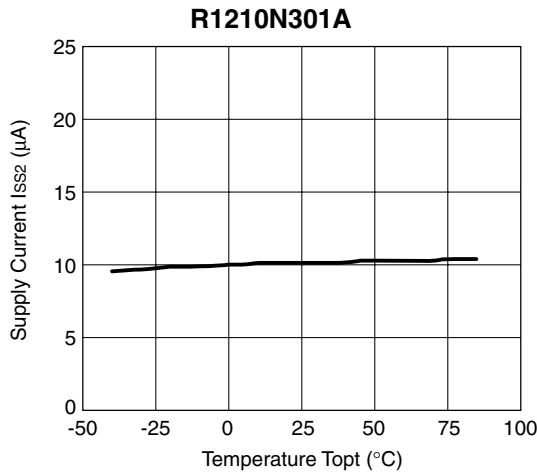

9) Standby Current vs. Temperature

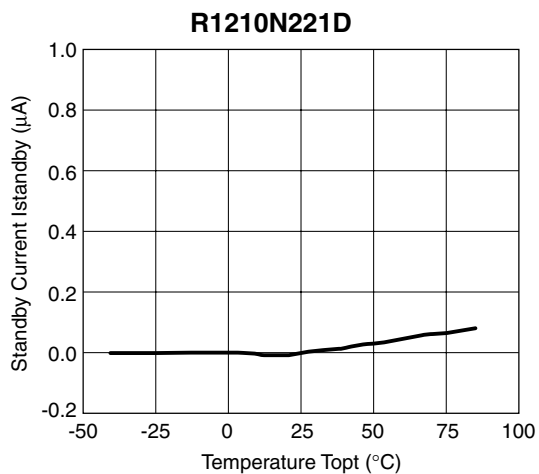
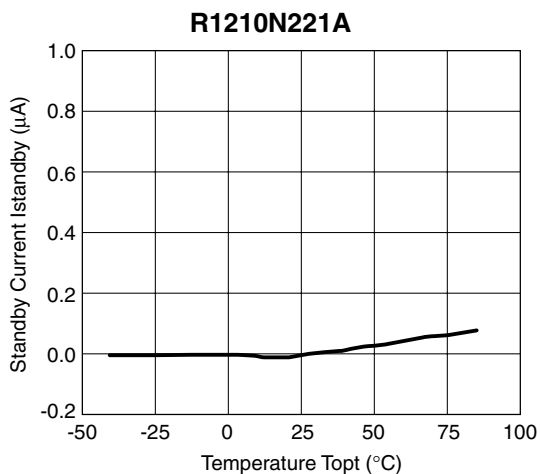

10) Oscillator Frequency vs. Temperature



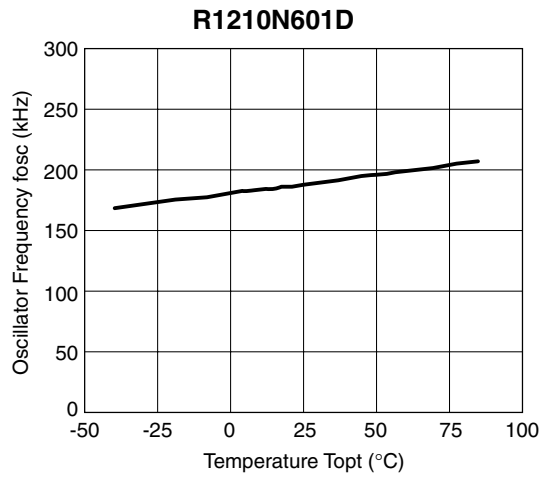

11) Maximum Duty Cycle vs. Temperature

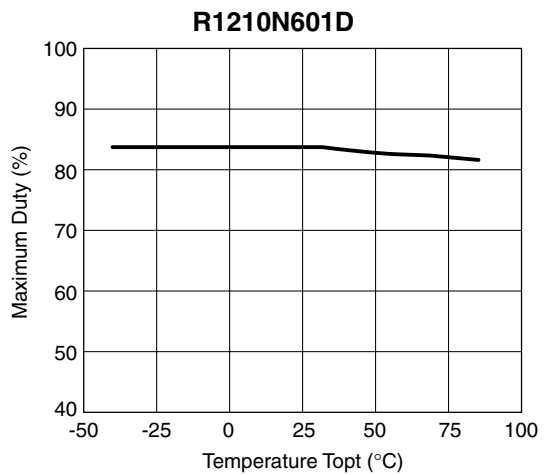
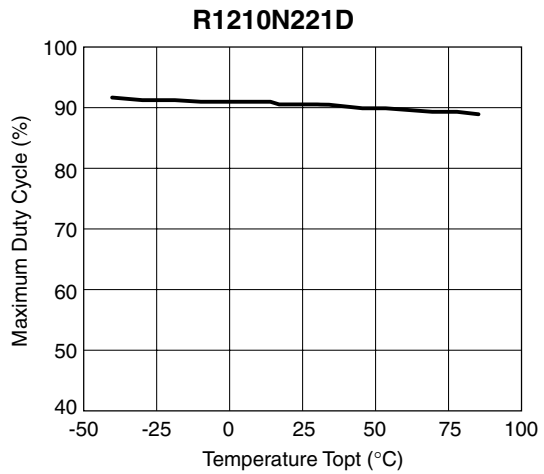

12) Lx Switching Current vs. Temperature



13) Lx leakage Current vs. Temperature



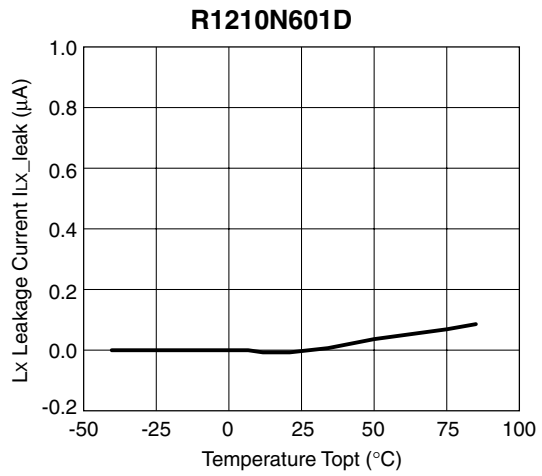
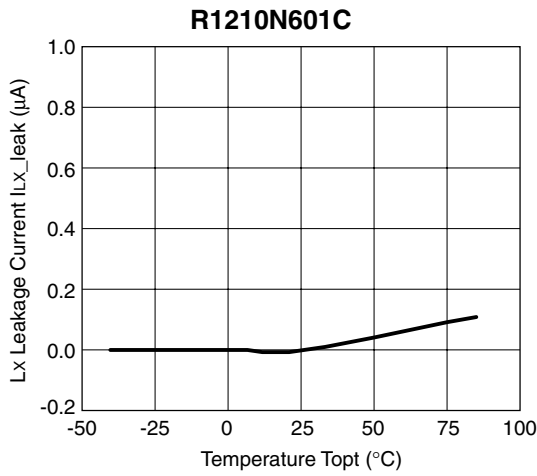

14) VLx Voltage Limit vs. Temperature

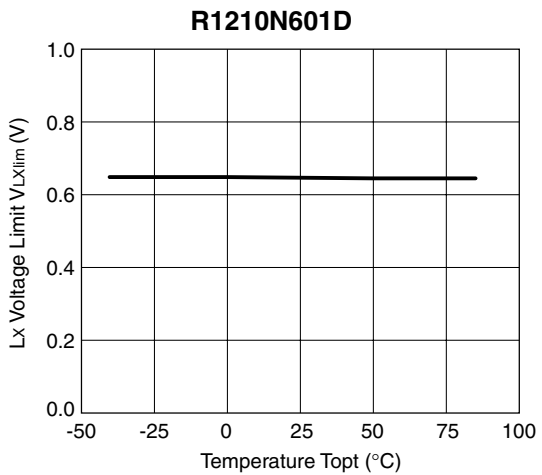
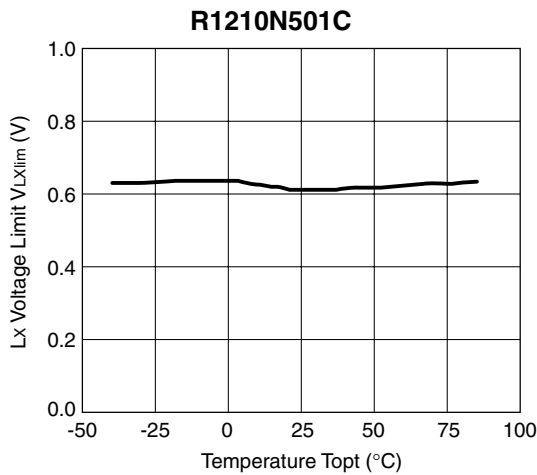
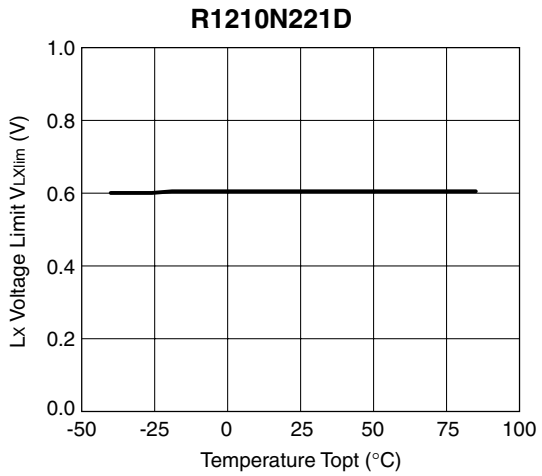
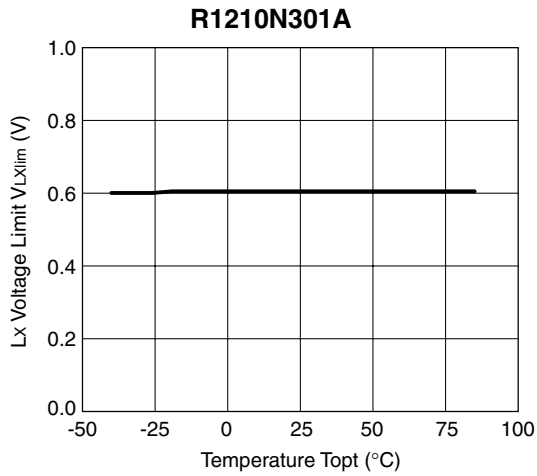

15) CE "H" Input Voltage vs. Temperature

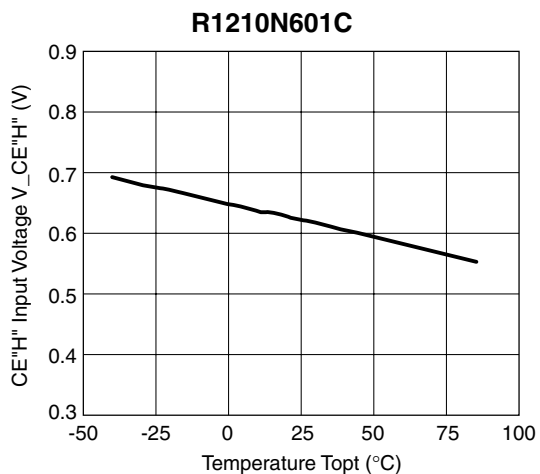
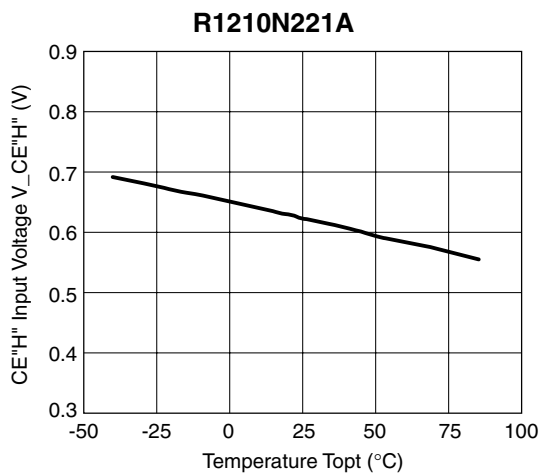

16) CE "L" Input Voltage vs. Temperature

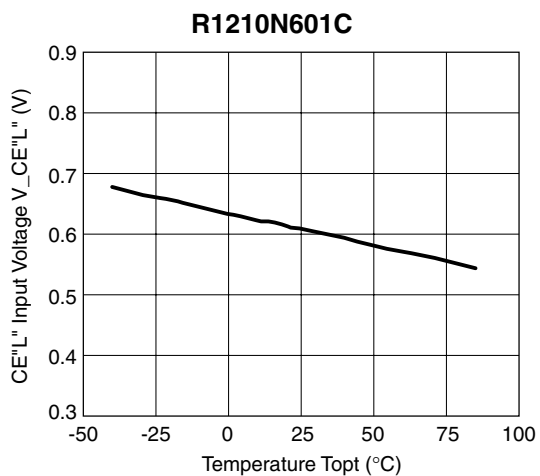
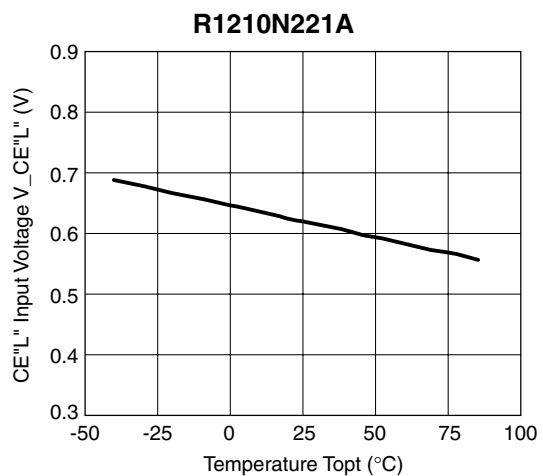

Компания «Океан Электроники» предлагает заключение долгосрочных отношений при поставках импортных электронных компонентов на взаимовыгодных условиях!

Наши преимущества:

- Поставка оригинальных импортных электронных компонентов напрямую с производств Америки, Европы и Азии, а так же с крупнейших складов мира;
- Широкая линейка поставок активных и пассивных импортных электронных компонентов (более 30 млн. наименований);
- Поставка сложных, дефицитных, либо снятых с производства позиций;
- Оперативные сроки поставки под заказ (от 5 рабочих дней);
- Экспресс доставка в любую точку России;
- Помощь Конструкторского Отдела и консультации квалифицированных инженеров;
- Техническая поддержка проекта, помощь в подборе аналогов, поставка прототипов;
- Поставка электронных компонентов под контролем ВП;
- Система менеджмента качества сертифицирована по Международному стандарту ISO 9001;
- При необходимости вся продукция военного и аэрокосмического назначения проходит испытания и сертификацию в лаборатории (по согласованию с заказчиком);
- Поставка специализированных компонентов военного и аэрокосмического уровня качества (Xilinx, Altera, Analog Devices, Intersil, Interpoint, Microsemi, Actel, Aeroflex, Peregrine, VPT, Syfer, Eurofarad, Texas Instruments, MS Kennedy, Miteq, Cobham, E2V, MA-COM, Hittite, Mini-Circuits, General Dynamics и др.);

Компания «Океан Электроники» является официальным дистрибьютором и эксклюзивным представителем в России одного из крупнейших производителей разъемов военного и аэрокосмического назначения «JONHON», а так же официальным дистрибьютором и эксклюзивным представителем в России производителя высокотехнологичных и надежных решений для передачи СВЧ сигналов «FORSTAR».



JONHON

«JONHON» (основан в 1970 г.)

Разъемы специального, военного и аэрокосмического назначения:

(Применяются в военной, авиационной, аэрокосмической, морской, железнодорожной, горно- и нефтедобывающей отраслях промышленности)

«FORSTAR» (основан в 1998 г.)

ВЧ соединители, коаксиальные кабели, кабельные сборки и микроволновые компоненты:

(Применяются в телекоммуникациях гражданского и специального назначения, в средствах связи, РЛС, а так же военной, авиационной и аэрокосмической отраслях промышленности).



Телефон: 8 (812) 309-75-97 (многоканальный)

Факс: 8 (812) 320-03-32

Электронная почта: ocean@oceanchips.ru

Web: <http://oceanchips.ru/>

Адрес: 198099, г. Санкт-Петербург, ул. Калинина, д. 2, корп. 4, лит. А