

3M™ LATCH/EJECT HEADER, 1552 SERIES

2MM X 2MM STRAIGHT & RIGHT ANGLE, THROUGH-HOLE, STRAIGHT & SURFACE MOUNT



5 1552XX-X20X
LATCH MATING FOR
MOLDED-ON SOCKET
WITH LATCHING EAR



5 1552XX-X30X
LATCH MATING FOR
PRESS-ON SOCKET

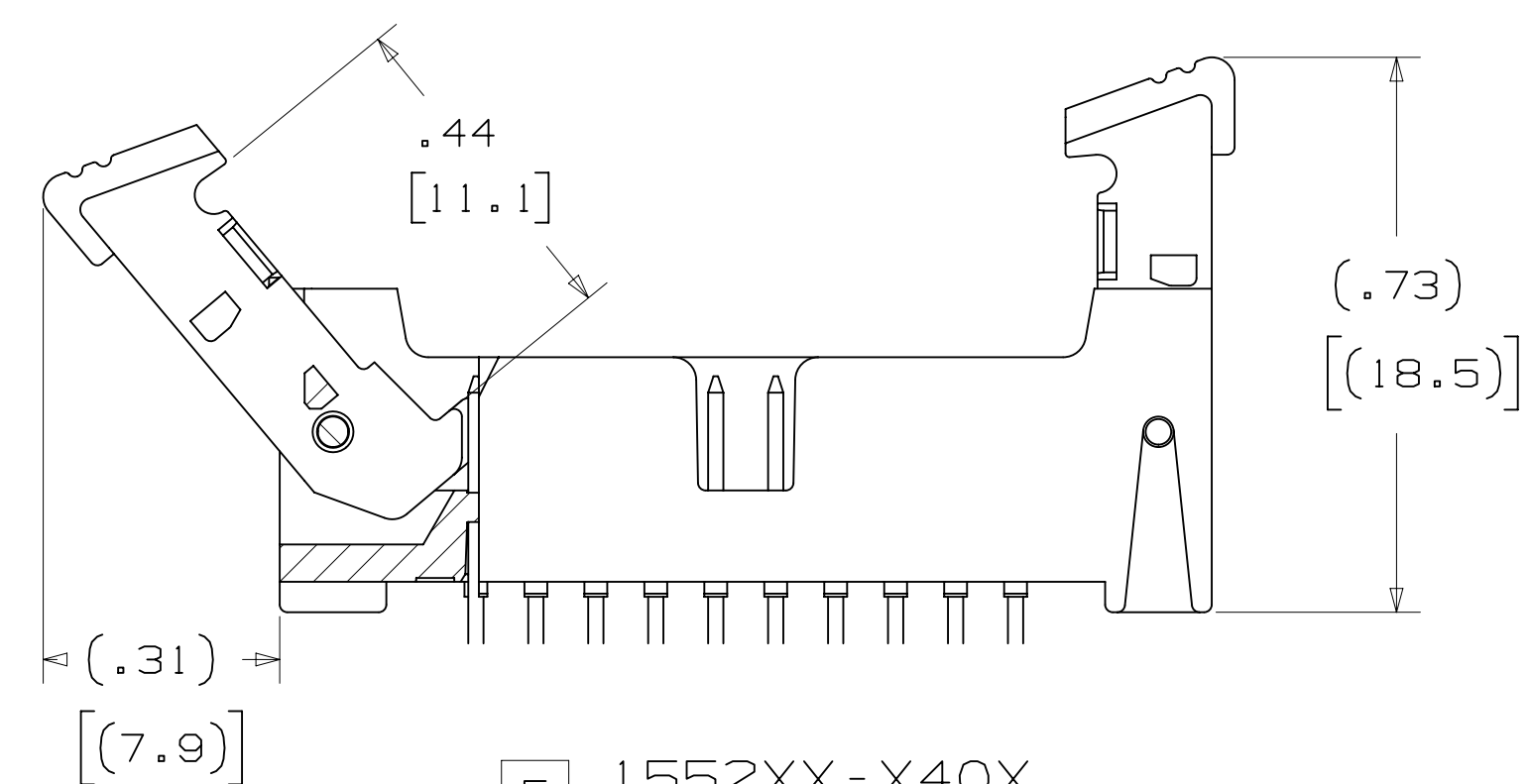

5 1552XX-X40X
LATCH MATING FOR
2MM SCI CARRIER

3 ELECTRICAL PERFORMANCE:

CURRENT RATING: 4.75A, 1 LINE POWERED
2.00A, 6 ADJACENT LINES POWERED
1.25A, ALL LINES POWERED

RATING CONDITIONS: EIA-364-070 METHOD 2, 30°C MAXIMUM TEMPERATURE RISE, 20% DERATED. REFERENCE APPROPRIATE 3M PRODUCT SPECIFICATION FOR DETAILED CURRENT DERATING CURVES.

INSULATION RESISTANCE: > 1X10⁹ OHMS AT 500 V_{DC}
WITHSTANDING VOLTAGE (1552XX): 1000 V_{RMS} AT SEA LEVEL
WITHSTANDING VOLTAGE (G1552XX): 750 V_{RMS} AT SEA LEVEL

3 ENVIRONMENTAL:

TEMPERATURE RATING: -55°C TO +105°C
PROCESS RATING: MAXIMUM 260°C (PER J-STD-020)
MOISTURE SENSITIVITY LEVEL: 1 (PER J-STD-020)

- * 14 PIN COUNTS RANGING FROM 06 TO 50 POSITIONS.
- * LATCH/EJECT MECHANISM SECURELY LATCHES TO SOCKET.
- * ROLL PINS RETAIN LATCHES TO BODY IN SHIPPING AND HIGH VIBRATION ENVIRONMENTS.
- * EJECTOR HELPS MAKE UNMATING OF CABLE ASSEMBLIES EASIER.
- * HIGH TEMPERATURE INSULATORS SUITABLE FOR LEAD FREE PROCESSING.
- * ROBUST SYSTEM SOLUTION WHEN USED WITH 3M IDC WIREMOUNT SOCKETS OR 3M MOLDED CABLE ASSEMBLIES.
- * SMT LATCH/EJECT HEADERS ARE AVAILABLE IN TAPE AND REEL WITH VACUUM CAP FOR AUTOMATIC PLACEMENT.

CONTACT QTY.	DIM. "A"	DIM. "B"	DIM. "D"	LATCH OPTION	TAPE WIDTH	ORDER CODE	CONTACT QTY.
06	.673 [17.09]	.157 [4.00]	.333 [8.45]	2, 4	44 MM	WD	06
08	.752 [19.10]	.236 [6.00]	.411 [10.44]	2, 4	44 MM	WD	08
10	.831 [21.10]	.315 [8.00]	.490 [12.45]	2, 3, 4	44 MM	WD	10
12	.910 [23.10]	.394 [10.00]	.569 [14.45]	3, 4	44 MM	WD	12
16	1.067 [27.10]	.551 [14.00]	.726 [18.44]	2, 4	56 MM	WE	16
20	1.224 [31.09]	.709 [18.00]	.884 [22.45]	2, 3, 4	56 MM	WE	20
22	1.303 [33.10]	.787 [20.00]	.963 [24.46]	2, 4	56 MM	WE	22
24	1.382 [35.10]	.866 [22.00]	1.041 [26.44]	2, 4	56 MM	WE	24
26	1.461 [37.10]	.945 [24.00]	1.120 [28.45]	2, 3, 4	72 MM	WF	26
30	1.618 [41.10]	1.102 [28.00]	1.278 [32.46]	2, 4	72 MM	WF	30
34	1.774 [45.09]	1.260 [32.00]	1.435 [36.46]	2, 4	72 MM	WF	34
40	2.012 [51.10]	1.496 [38.00]	1.671 [42.44]	2, 3, 4	72 MM	WF	40
44	2.169 [55.09]	1.654 [42.00]	1.829 [46.46]	2, 3, 4	88 MM	WG	44
50	2.405 [61.09]	1.980 [48.00]	2.065 [54.45]	2, 3, 4	88 MM	WG	50

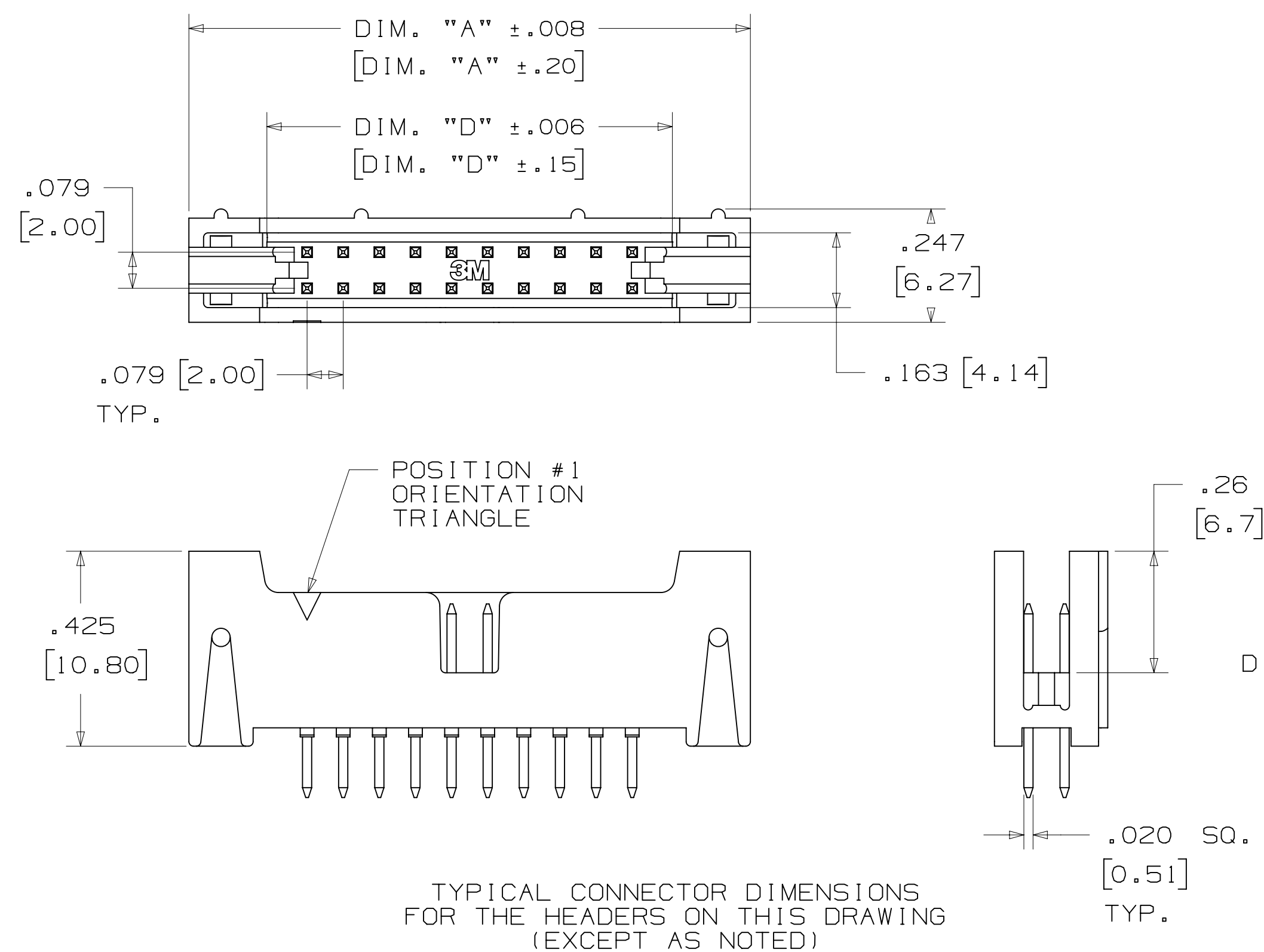

TYPICAL CONNECTOR DIMENSIONS FOR THE HEADERS ON THIS DRAWING (EXCEPT AS NOTED)

DIMENSIONS: MM [INCHES]

- NOTES
- MATERIAL:
PLASTIC:
GLASS FILLED POLYESTER (LCP)
UL94V-0, BLACK
CONTACT: COPPER ALLOY.
 - PLATING:
50μ NICKEL UNDERPLATING
WIPE AREA: SEE ORDERING INFO.
SOLDER TAIL: 200μ MATTE TIN.
 - IN THE EVENT OF CONFLICT BETWEEN THIS DATA AND THAT CONTAINED IN THE PRODUCT SPECIFICATION, THE PRODUCT SPECIFICATION TAKES PRECEDENT.
 - REGULATORY INFORMATION:
VISIT 3M.com/regs OR CONTACT YOUR 3M REPRESENTATIVE TO FIND THE RoHS COMPLIANCE STATUS OF THE 3M PART YOU ARE INTERESTED IN.
 - SEE TABLE 1 FOR LATCH AVAILABILITY.
 - MATING COMPATIBILITY SERIES:
1522, 870, 2M AND 2MM SCI CARRIER (93XX).
 - SURFACE MOUNT VERSION:
ORDER CODE APPLIES TO THE TAPE AND REEL WIDTH.

3M ELECTRONICS MATERIALS SOLUTIONS DIVISION
INTERCONNECT SOLUTIONS
<http://www.3mconnectors.com>

3M IS A TRADEMARK OF 3M COMPANY.
FOR TECHNICAL, SALES OR ORDERING
INFORMATION CALL 800-225-5373

DESIGN REFERENCE	NEXT ASSEMBLY	REV	ECO	ISSUE DATE AND DESCRIPTION	DRFT	CHKD
DIVISION	DIVISION CODE	DATE	DATE	DATE	DATE	DATE
	EMSD	JAN 21, 2015	JAN 21, 2015	JAN 21, 2015	JAN 21, 2015	JAN 21, 2015
DO NOT SCALE DRAWING	SCALE 4/1	TOLERANCES EXCEPT AS NOTED		INCHES		
				.00 ± .01		
				.000 ± .008		
				.0000 ±		
				MILLIMETERS		
				0 ± .3		
				.00 ± .20		
				.000 ±		
				ANGLES		
				MARKED ONLY		
3M		© 3M COPYRIGHT 2017		This document and the information it contains are 3M property and may not be reproduced or further distributed without 3M permission, or used or disclosed other than for 3M authorized purposes. All rights reserved.		
L 58601		AUG 11, 2016		JNC		RS
		8-11-16 ADD SHT 4		REVISE TRADEMAKING NOTE JUN 01, 2016		
		PRODUCTION RELEASE, APR 29, 2016				
TITLE		LATCH/EJECT HEADER, 2MM, STRAIGHT, RIGHT ANGLE & SMT				
CAGE NUMBER	SIZE	DRAWING NO.	REV.			
D		78-5100-2199-7	L			
MODEL	1552	DET	ISTS	YES	NO	SHT 1 OF 4

78-5100-2199-7
DRAWING NUMBER
Imaged: L.6 Central Time 5/17/2017 UTC Offset

3M™ LATCH/EJECT HEADER, 1552 SERIES
2MM X 2MM STRAIGHT & RIGHT ANGLE, THROUGH-HOLE, STRAIGHT & SURFACE MOUNT

STRAIGHT VERSION



ORDERING INFORMATION
1552XX-6X0X-XX

CONTACT QUANTITY: PLATING OPTIONS:
 RB = 30µIN [.76µm] GOLD
 RA = 10µIN [.25µm] GOLD
 (RIA E1 & C1 APPLY) FOR BOTH PLATINGS

LATCHING OPTIONS:
 2 = LATCH, MOLDED-ON SOCKET WITH LATCHING EARS, SERIES: 870, 2MM
 3 = LATCH, PRESS-ON SOCKET, SERIES: 1522
 4 = LATCH, 2MM SCI CARRIER ONLY, SERIES: 93XX

SOLDER TAIL LENGTH:
 DIMENSION "E"
 2 = .112 [2.84]
 3 = .155 [3.94]

STRAIGHT VERSION WITH INTERSTITIAL GROUNDS

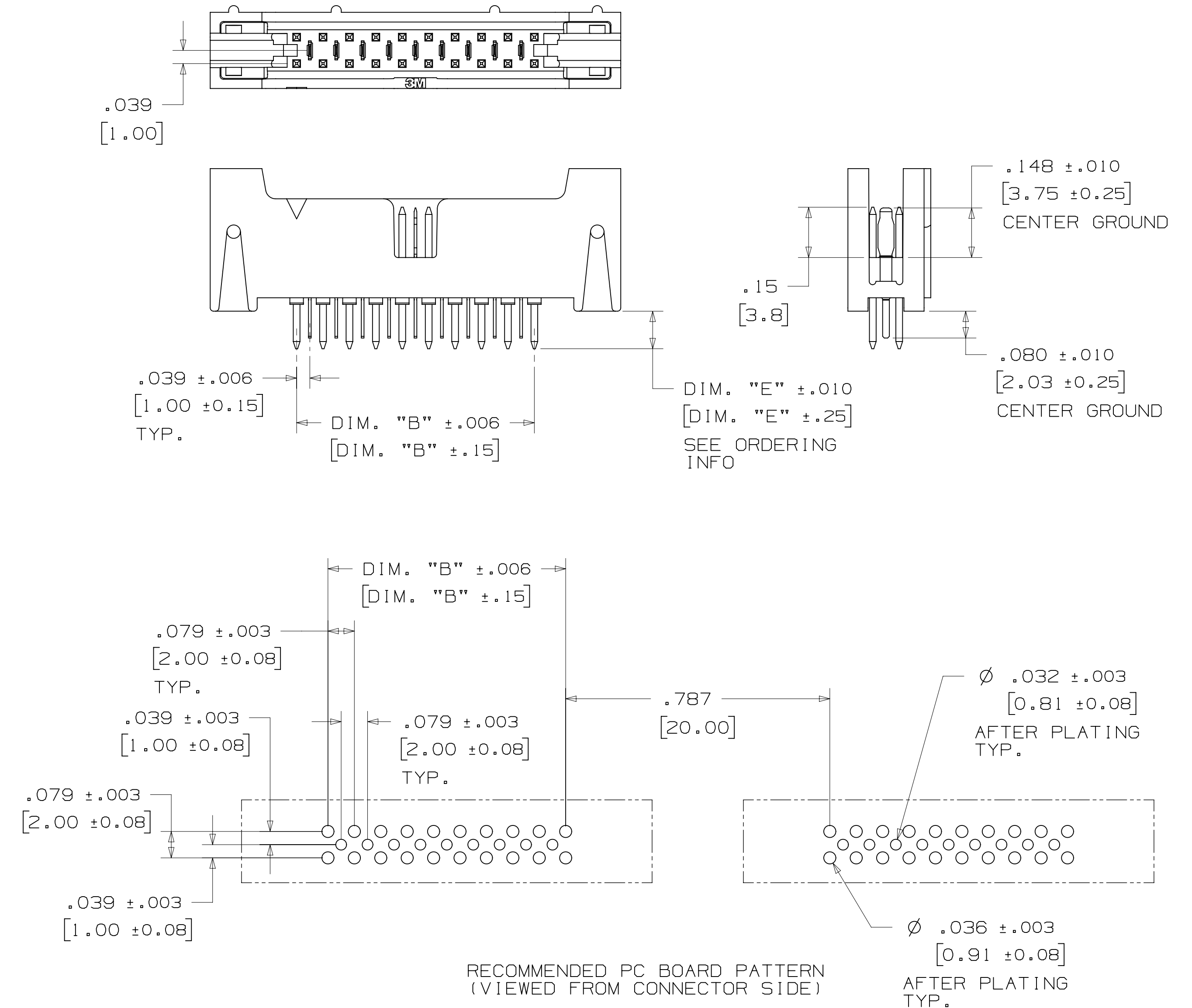

ORDERING INFORMATION
G1552XX-6X0X-XX

CONTACT QUANTITY: PLATING OPTIONS:
 RB = 30µIN [.76µm] GOLD
 RA = 10µIN [.25µm] GOLD
 (RIA E1 & C1 APPLY) FOR BOTH PLATINGS

LATCHING OPTIONS:
 4 = LATCH, 2MM SCI CARRIER ONLY, SERIES 93XX

SOLDER TAIL LENGTH:
 DIMENSION "E"
 2 = .112 [2.84]

DESIGN REFERENCE	NEXT ASSEMBLY	REV	ECO	ISSUE DATE AND DESCRIPTION	DRFT	CHKD
DATE	DATE	DATE	DATE	DATE	DATE	DATE
CHKD	DATE	APPV	DATE			
		R. SCHERER	JAN 21, 2015			
DIVISION	DIVISION CODE	© 3M COPYR [GHT] 2017 This document and the information it contains are 3M property and may not be reproduced or further distributed without 3M permission, or used or disclosed other than for 3M authorized purposes. All rights reserved.				
DO NOT SCALE DRAWING	SCALE 4/1	TOLERANCES EXCEPT AS NOTED	3M Center St. Paul, MN 55144			
THIRD ANGLE PROJECTION	INCHES .00 ±.01 .000 ±.008 .0000 ±	MILLIMETERS 0 ± .0 ±.3 .00 ±.20	TITLE LATCH/EJECT HEADER, 2MM, STRAIGHT, RIGHT ANGLE & SMT			
MAX SURFACE ROUGHNESS	MARKED ONLY	ANGLS	CAGE NUMBER	SIZE	DRAWING NO.	REV.
			D	78-5100-2199-7	L	
			MODEL	1552	DET	ISTS <input type="checkbox"/> YES <input checked="" type="checkbox"/> NO SHT 2 OF 4

78-5100-2199-7 DRAWING NUMBER
 1552
 8-11-16 ADD SHT 4
 REVISE TRADEMAKE NOTE JUN 01, 2016
 PRODUCTION RELEASE, APR 29, 2016
 JNC RS
 Standard Time5/17/2017UTC Offset

3M™ LATCH/EJECT HEADER, 1552 SERIES
2MM X 2MM STRAIGHT & RIGHT ANGLE, THROUGH-HOLE, STRAIGHT & SURFACE MOUNT

RIGHT ANGLE VERSION

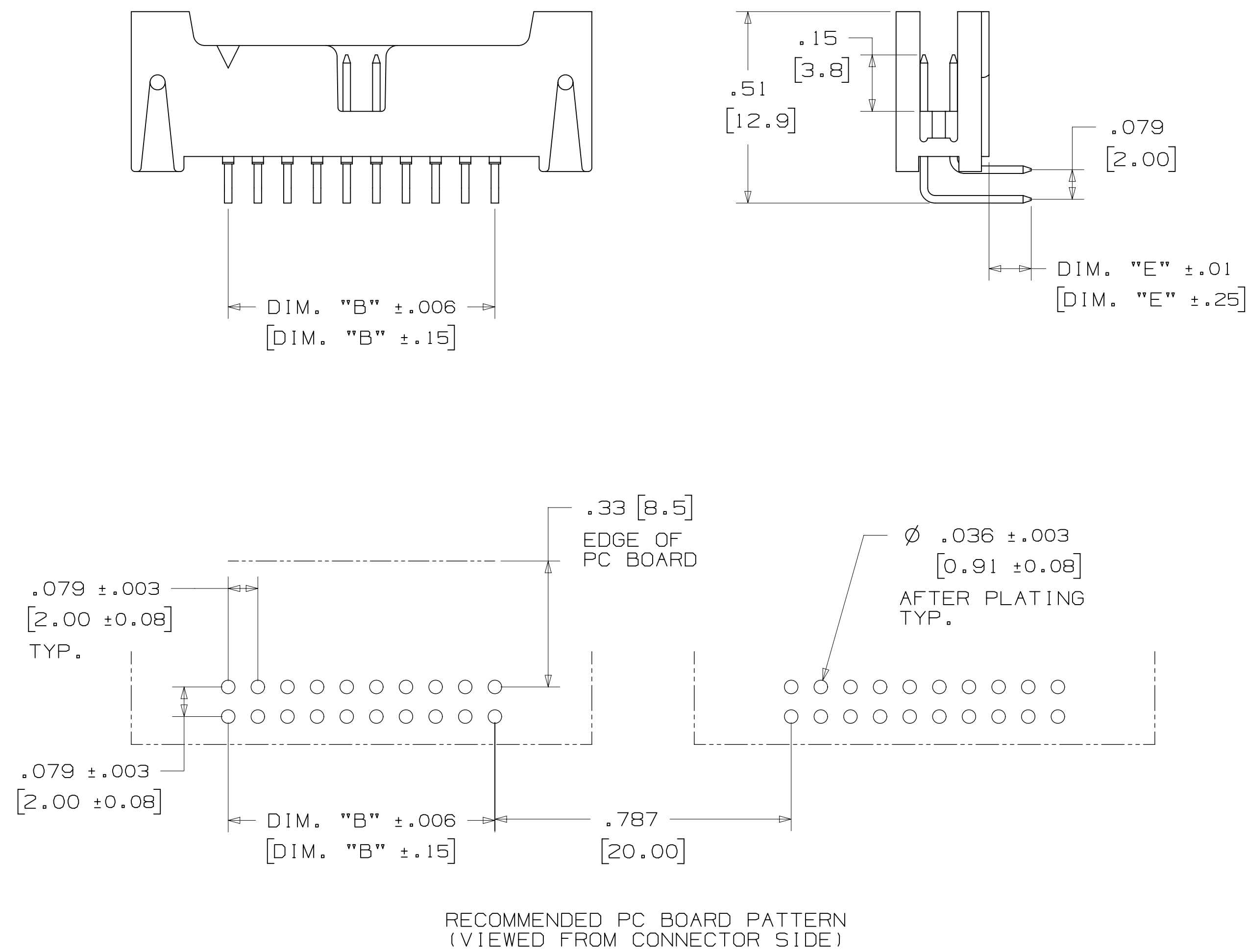

ORDERING INFORMATION
1552XX-5X0X-XX

LATCHING OPTIONS:
2 = LATCH, MOLDED-ON SOCKET WITH LATCHING EARS, SERIES: 870, 2MM
3 = LATCH, PRESS-ON SOCKET, SERIES: 1522
4 = LATCH, 2MM SCI CARRIER ONLY, SERIES 93XX

PLATING OPTIONS:
RB = 30µIN [.76µm] GOLD
RA = 10µIN [.25µm] GOLD (RIA E1 & C1 APPLY) FOR BOTH PLATINGS

SOLDER TAIL LENGTH:
DIMENSION "E"
2 = .112 [2.84]
3 = .155 [3.94]

CONTACT QUANTITY: _____

SURFACE MOUNT VERSION

NOTES:
1) TAPE & REEL PARTS ALWAYS SUPPLIED WITH VACUUM PICK-UP CAP.
2) TAPE & REEL NOT AVAILABLE WITH SCI LATCH OPTION.
3) TRAY PARTS SUPPLIED WITHOUT VACUUM PICK-UP CAP.

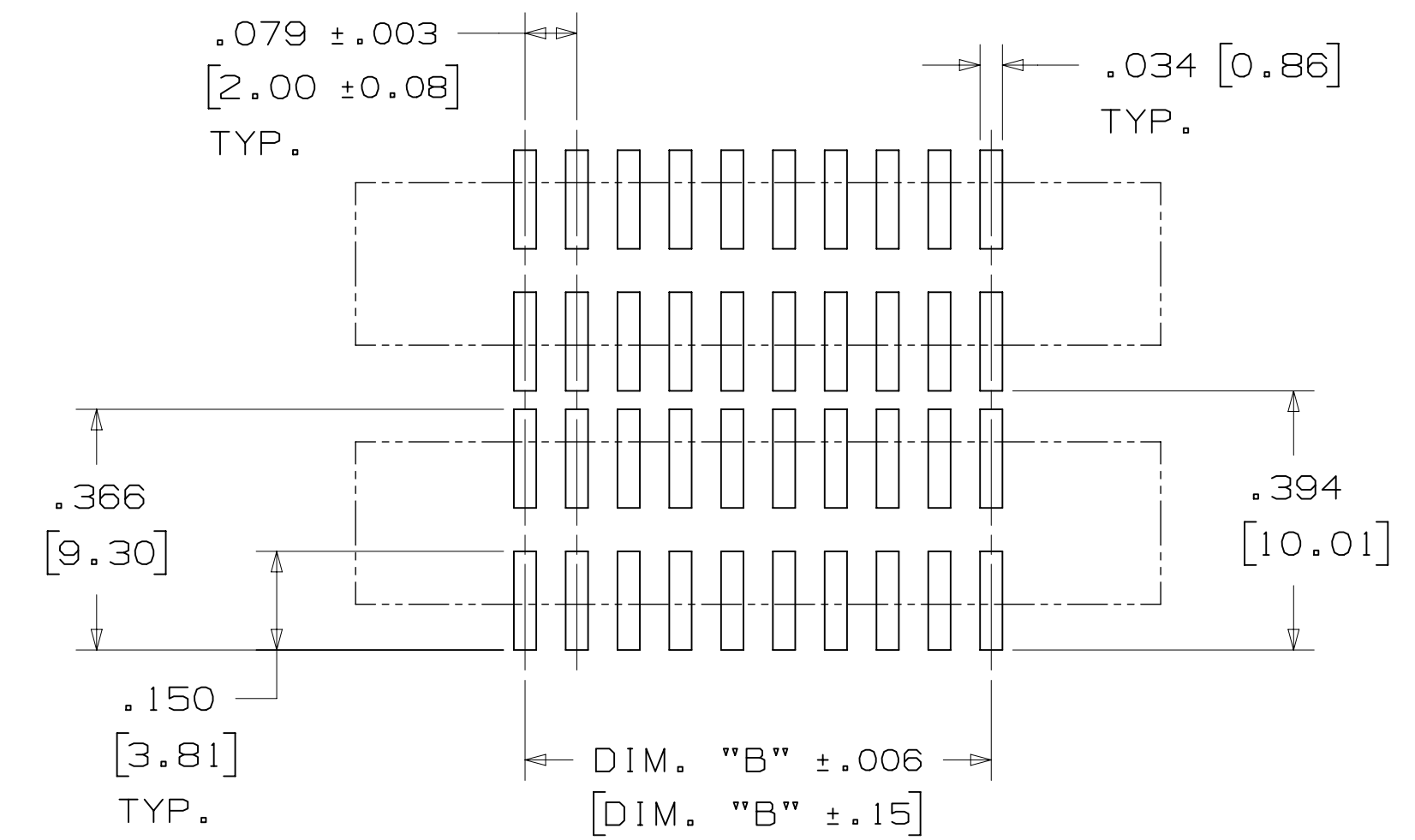
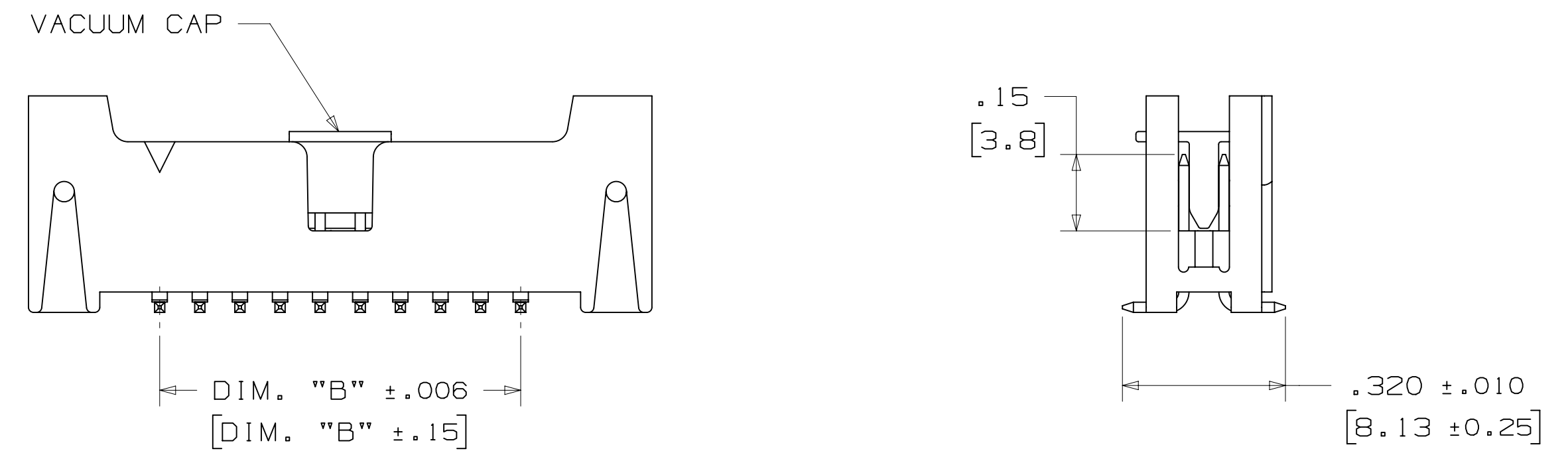

RECOMMENDED PC BOARD PATTERN
(VIEWED FROM CONNECTOR SIDE)

ORDERING INFORMATION

1552XX-2X00-XX-XX

CONTACT QUANTITY: _____

LATCHING OPTIONS:
2 = LATCH, MOLDED-ON SOCKET WITH LATCHING EARS, SERIES: 870, 2MM
3 = LATCH, PRESS-ON SOCKET, SERIES: 1522
4 = LATCH, 2MM SCI CARRIER ONLY, SERIES 93XX

PACKAGING:
BLANK = TRAYS
WX = TAPE & REEL (SEE TABLE 1 ORDER CODE)

PLATING OPTIONS:
RB = 30µIN [.76µm] GOLD
RA = 10µIN [.25µm] GOLD (RIA E1 & C1 APPLY) FOR BOTH PLATINGS

DESIGN REFERENCE	NEXT ASSEMBLY	REV	ECO	ISSUE DATE AND DESCRIPTION	DRFT	CHKD
DATE	DATE	DATE	DATE	DATE	DATE	DATE
CHKD	APPV	DATE	DATE	DATE	DATE	DATE
DIVISION	DIVISION CODE	L 58601 AUG 11, 2016 8-11-16 ADD SHT 4 REVISE TRADEMAKE NOTE JUN 01, 2016 PRODUCTION RELEASE, APR 29, 2016				
DO NOT SCALE DRAWING	SCALE 4/1	TOLERANCES EXCEPT AS NOTED INCHES .00 ±.01 .000 ±.008 .0000 ±				
THIRD ANGLE PROJECTION	INTERPRET PER ASME Y14.5 - 2009	MILLIMETERS 0 ±.3 .00 ±.20 .000 ±				
MAX SURFACE ROUGHNESS	MARKED ONLY	CAGE NUMBER D78-5100-2199-7 MODEL 1552 DET. YES NO SHT 3 OF 4				

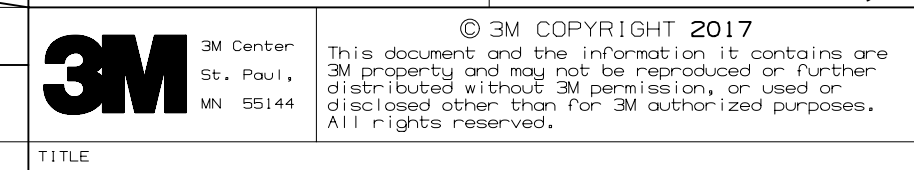

TITLE
LATCH/EJECT HEADER,
2MM, STRAIGHT, RIGHT
ANGLE & SMT

REVISION

Imaged: L.6 Central Standard Time 5/17/2017 UTC OffSet

3M™ LATCH/EJECT HEADER, 1552 SERIES
 2MM X 2MM STRAIGHT & RIGHT ANGLE, THROUGH-HOLE, STRAIGHT & SURFACE MOUNT

Technical Information: The technical information, recommendations and other statements contained in this document are based upon tests or experience that 3M believes are reliable, but the accuracy or completeness of such information is not guaranteed.

Product Use: Many factors beyond 3M's control and uniquely within user's knowledge and control can affect the use and performance of a 3M product in a particular application. Given the variety of factors that can affect the use and performance of a 3M product, user is solely responsible for evaluating the 3M product and determining whether it is fit for a particular purpose and suitable for user's method of application.

Warranty, Limited Remedy, and Disclaimer: Unless an additional warranty is specifically stated on the applicable 3M product packaging or product literature, 3M warrants that each 3M product meets the applicable 3M product specification at the time 3M ships the product. 3M MAKES NO OTHER WARRANTIES OR CONDITIONS, EXPRESS OR IMPLIED, INCLUDING, BUT NOT LIMITED TO, ANY IMPLIED WARRANTY OR CONDITION OF MERCHANTABILITY OR FITNESS FOR A PARTICULAR PURPOSE OR ANY IMPLIED WARRANTY OR CONDITION ARISING OUT OF A COURSE OF DEALING, CUSTOM OR USAGE OF TRADE. If the 3M product does not conform to this warranty, then the sole and exclusive remedy is, at 3M's option, replacement of the 3M product or refund of the purchase price.

Limitation of Liability: Except where prohibited by law, 3M will not be liable for any loss or damage arising from the 3M product, whether direct, indirect, special, incidental or consequential, regardless of the legal theory asserted, including warranty, contract, negligence or strict liability.

Unless otherwise noted, references to industry specifications are intended to indicate substantial compliance to the material elements of the specification. Such references should not be construed as a guarantee of compliance to all requirements in a given specification.

DESIGN REFERENCE	NEXT ASSEMBLY	REV	ECO	ISSUE DATE AND DESCRIPTION	DRFT	CHKD
APPROVED	DATE	DATE	DATE	DATE	DATE	DATE
CHKD	DATE	DATE	DATE	DATE	DATE	DATE
DIVISION	DIVISION CODE	3M Center St. Paul, MN 55144		© 3M COPYRIGHT 2017 This document and the information it contains are 3M property and may not be reproduced or further distributed without 3M permission, or used or disclosed other than for 3M authorized purposes. All rights reserved.		
DO NOT SCALE DRAWING	SCALE 1/1	TOLERANCES EXCEPT AS NOTED		TITLE		
		INCHES .00 ± .01 .000 ± .008 .0000 ±		LATCH/EJECT HEADER, 2MM, STRAIGHT, RIGHT ANGLE & SMT		
THIRD ANGLE PROJECTION	INTERPRET PER ASME Y14.5 - 2009	MILLIMETERS 0 ± .0 ± .3 .00 ± .20 .000 ±		CAGE NUMBER		
MAX SURFACE ROUGHNESS	MARKED SURFACES	MARKED ONLY		DRAWING NO. 78-5100-2199-7		
		MODEL 1552		REV. L		
				DET. YES X NO SHT 4 OF 4		

78-5100-2199-7 DRAWING NUMBER
 1552
 Standard Time5/17/2017UTC Offrset

Компания «Океан Электроники» предлагает заключение долгосрочных отношений при поставках импортных электронных компонентов на взаимовыгодных условиях!

Наши преимущества:

- Поставка оригинальных импортных электронных компонентов напрямую с производств Америки, Европы и Азии, а так же с крупнейших складов мира;
- Широкая линейка поставок активных и пассивных импортных электронных компонентов (более 30 млн. наименований);
- Поставка сложных, дефицитных, либо снятых с производства позиций;
- Оперативные сроки поставки под заказ (от 5 рабочих дней);
- Экспресс доставка в любую точку России;
- Помощь Конструкторского Отдела и консультации квалифицированных инженеров;
- Техническая поддержка проекта, помощь в подборе аналогов, поставка прототипов;
- Поставка электронных компонентов под контролем ВП;
- Система менеджмента качества сертифицирована по Международному стандарту ISO 9001;
- При необходимости вся продукция военного и аэрокосмического назначения проходит испытания и сертификацию в лаборатории (по согласованию с заказчиком);
- Поставка специализированных компонентов военного и аэрокосмического уровня качества (Xilinx, Altera, Analog Devices, Intersil, Interpoint, Microsemi, Actel, Aeroflex, Peregrine, VPT, Syfer, Eurofarad, Texas Instruments, MS Kennedy, Miteq, Cobham, E2V, MA-COM, Hittite, Mini-Circuits, General Dynamics и др.);

Компания «Океан Электроники» является официальным дистрибьютором и эксклюзивным представителем в России одного из крупнейших производителей разъемов военного и аэрокосмического назначения «JONHON», а так же официальным дистрибьютором и эксклюзивным представителем в России производителя высокотехнологичных и надежных решений для передачи СВЧ сигналов «FORSTAR».



JONHON

«JONHON» (основан в 1970 г.)

Разъемы специального, военного и аэрокосмического назначения:

(Применяются в военной, авиационной, аэрокосмической, морской, железнодорожной, горно- и нефтедобывающей отраслях промышленности)

«FORSTAR» (основан в 1998 г.)

ВЧ соединители, коаксиальные кабели,
кабельные сборки и микроволновые компоненты:

(Применяются в телекоммуникациях гражданского и специального назначения, в средствах связи, РЛС, а так же военной, авиационной и аэрокосмической отраслях промышленности).



Телефон: 8 (812) 309-75-97 (многоканальный)

Факс: 8 (812) 320-03-32

Электронная почта: ocean@oceanchips.ru

Web: <http://oceanchips.ru/>

Адрес: 198099, г. Санкт-Петербург, ул. Калинина, д. 2, корп. 4, лит. А