

Optocoupler, Phototransistor Output, With Base Connection, High BV_{CER} Voltage



#179004



DESCRIPTION

The H11D1/H11D2/H11D3/H11D4 are optocouplers with very high BV_{CER} . They are intended for telecommunications applications or any DC application requiring a high blocking voltage.

The H11D1/H11D2 are identical and the H11D3/H11D4 are identical.

FEATURES

- CTR at $I_F = 10 \text{ mA}$, $BV_{CER} = 10 \text{ V}$: $\geq 20 \%$
- Good CTR linearly with forward current
- Low CTR degradation
- Very high collector emitter breakdown voltage
 - H11D1/H11D2, $BV_{CER} = 300 \text{ V}$
 - H11D3/H11D4, $BV_{CER} = 200 \text{ V}$
- Isolation test voltage: 5300 V_{RMS}
- Low coupling capacitance
- High common mode transient immunity
- Package with base connection
- Lead (Pb)-free component
- Component in accordance to RoHS 2002/95/EC and WEEE 2002/96/EC



RoHS
COMPLIANT

AGENCY APPROVALS

- UL1577, file no. E52744 system code H or J, double protection
- DIN EN 60747-5-2 (VDE0884)
DIN EN 60747-5-5 pending available with option 1
- BSI IEC60950 IEC60065
- FIMKO

APPLICATIONS

- Telecommunications
- Replace relays

ORDER INFORMATION	
PART	REMARKS
H11D1	CTR > 20 %, DIP-6
H11D2	CTR > 20 %, DIP-6
H11D3	CTR > 20 %, DIP-6
H11D4	CTR > 20 %, DIP-6
H11D1-X007	CTR > 20 %, SMD-6 (option 7)
H11D1-X009	CTR > 20 %, SMD-6 (option 9)
H11D2-X007	CTR > 20 %, SMD-6 (option 7)
H11D3-X007	CTR > 20 %, SMD-6 (option 7)

Note

For additional information on the available options refer to option information.

H11D1/H11D2/H11D3/H11D4



Vishay Semiconductors Optocoupler, Phototransistor Output,
With Base Connection, High BV_{CER} Voltage

ABSOLUTE MAXIMUM RATINGS					
PARAMETER	TEST CONDITION	PART	SYMBOL	VALUE	UNIT
INPUT					
Reverse voltage			V_R	6	V
DC forward current			I_F	60	mA
Surge forward current	$t \leq 10 \mu s$		I_{FSM}	2.5	A
Power dissipation			P_{diss}	100	mW
OUTPUT					
Collector emitter voltage		H11D1	V_{CE}	300	V
		H11D2	V_{CE}	300	V
		H11D3	V_{CE}	200	V
		H11D4	V_{CE}	200	V
Collector base voltage		H11D1	V_{CBO}	300	V
		H11D2	V_{CBO}	300	V
		H11D3	V_{CBO}	200	V
		H11D4	V_{CBO}	200	V
Emitter base voltage			V_{BEO}	7	V
Collector current			I_C	100	mA
Power dissipation			P_{diss}	300	mW
COUPLER					
Isolation test voltage	between emitter and detector, refer to climate DIN 50014, part 2, Nov. 74		V_{ISO}	5300	V_{RMS}
Insulation thickness between emitter and detector				≥ 0.4	mm
Creepage distance				≥ 7	mm
Clearance distance				≥ 7	mm
Comparative tracking index	per DIN IEC 112/VDE 0303, part 1			175	
Isolation resistance	$V_{IO} = 500 \text{ V}, T_{amb} = 25 \text{ }^\circ\text{C}$		R_{IO}	$\geq 10^{12}$	Ω
	$V_{IO} = 500 \text{ V}, T_{amb} = 100 \text{ }^\circ\text{C}$		R_{IO}	$\geq 10^{11}$	Ω
Storage temperature range			T_{stg}	- 55 to + 150	$^\circ\text{C}$
Operating temperature range			T_{amb}	- 55 to + 100	$^\circ\text{C}$
Junction temperature			T_j	100	$^\circ\text{C}$
Soldering temperature	max. 10 s, dip soldering: distance to seating plane $\geq 1.5 \text{ mm}$		T_{sld}	260	$^\circ\text{C}$

Note

$T_{amb} = 25 \text{ }^\circ\text{C}$, unless otherwise specified.

Stresses in excess of the absolute Maximum Ratings can cause permanent damage to the device. Functional operation of the device is not implied at these or any other conditions in excess of those given in the operational sections of this document. Exposure to absolute Maximum Rating for extended periods of the time can adversely affect reliability.



H11D1/H11D2/H11D3/H11D4

Optocoupler, Phototransistor Output, Vishay Semiconductors
With Base Connection, High BV_{CER} Voltage

ELECTRICAL CHARACTERISTICS							
PARAMETER	TEST CONDITION	PART	SYMBOL	MIN.	TYP.	MAX.	UNIT
INPUT							
Forward voltage	$I_F = 10 \text{ mA}$		V_F		1.1	1.5	V
Reverse voltage	$I_R = 10 \text{ } \mu\text{A}$		V_R	6			V
Reverse current	$V_R = 6 \text{ V}$		I_R		0.01	10	μA
Capacitance	$V_R = 0 \text{ V}, f = 1 \text{ MHz}$		C_O		25		pF
Thermal resistance			R_{thJA}		750		K/W
OUTPUT							
Collector emitter breakdown voltage	$I_{CE} = 1 \text{ mA}, R_{BE} = 1 \text{ M}\Omega$	H11D1	BV_{CER}	300			V
		H11D2	BV_{CER}	300			V
		H11D3	BV_{CER}	200			V
		H11D4	BV_{CER}	200			V
Emitter base breakdown voltage	$I_{EB} = 100 \text{ } \mu\text{A}$		BV_{EBO}	7			V
Collector emitter capacitance	$V_{CE} = 10 \text{ V}, f = 1 \text{ MHz}$		C_{CE}		7		pF
Collector base capacitance	$V_{CB} = 10 \text{ V}, f = 1 \text{ MHz}$		C_{CB}		8		pF
Emitter base capacitance	$V_{EB} = 5 \text{ V}, f = 1 \text{ MHz}$		C_{EB}		38		pF
Thermal resistance			R_{th}		250		K/W
COUPLER							
Coupling capacitance			C_C		0.6		pF
Current transfer ratio	$I_F = 10 \text{ mA}, V_{CE} = 10 \text{ V}, R_{BE} = 1 \text{ M}\Omega$		I_C/I_F	20			%
Collector emitter, saturation voltage	$I_F = 10 \text{ mA}, I_C = 0.5 \text{ mA}, R_{BE} = 1 \text{ M}\Omega$		V_{CEsat}		0.25	0.4	V
Collector emitter, leakage current	$V_{CE} = 200 \text{ V}, R_{BE} = 1 \text{ M}\Omega$	H11D1	I_{CER}			100	nA
		H11D2	I_{CER}			100	nA
	$V_{CE} = 300 \text{ V}, R_{BE} = 1 \text{ M}\Omega, T_{amb} = 100 \text{ } ^\circ\text{C}$	H11D1	I_{CER}			250	μA
		H11D2	I_{CER}			250	μA

Note

$T_{amb} = 25 \text{ } ^\circ\text{C}$, unless otherwise specified.

Minimum and maximum values were tested requirements. Typical values are characteristics of the device and are the result of engineering evaluations. Typical values are for information only and are not part of the testing requirements.

CURRENT TRANSFER RATIO							
PARAMETER	TEST CONDITION	PART	SYMBOL	MIN.	TYP.	MAX.	UNIT
Current transfer ratio	$I_F = 10 \text{ mA}, V_{CE} = 10 \text{ V}, R_{BE} = 1 \text{ M}\Omega$		CTR	20			%

SWITCHING CHARACTERISTICS							
PARAMETER	TEST CONDITION	SYMBOL	MIN.	TYP.	MAX.	UNIT	
Turn-on time	$I_C = 2 \text{ mA}$ (to be adjusted by varying I_F), $R_L = 100 \text{ } \Omega, V_{CC} = 10 \text{ V}$	t_{on}		5		μs	
Rise time	$I_C = 2 \text{ mA}$ (to be adjusted by varying I_F), $R_L = 100 \text{ } \Omega, V_{CC} = 10 \text{ V}$	t_r		2.5		μs	
Turn-off time	$I_C = 2 \text{ mA}$ (to be adjusted by varying I_F), $R_L = 100 \text{ } \Omega, V_{CC} = 10 \text{ V}$	t_{off}		6		μs	
Fall time	$I_C = 2 \text{ mA}$ (to be adjusted by varying I_F), $R_L = 100 \text{ } \Omega, V_{CC} = 10 \text{ V}$	t_f		5.5		μs	

Note

Switching times measurement-test circuit and waveforms

TYPICAL CHARACTERISTICS

$T_{amb} = 25\text{ }^{\circ}\text{C}$, unless otherwise specified



Fig. 1 - Current Transfer Ratio (typ.)



Fig. 4 - Output Characteristics



Fig. 2 - Diode Forward Voltage (typ.)

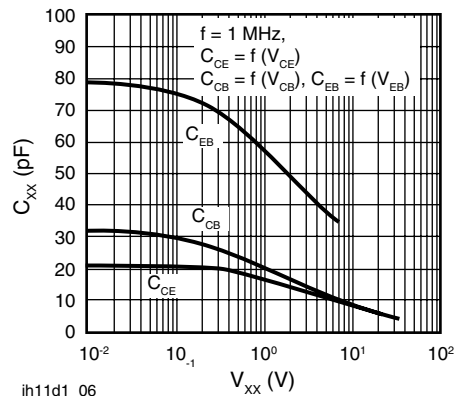

Fig. 5 - Transistor Capacitances (typ.)

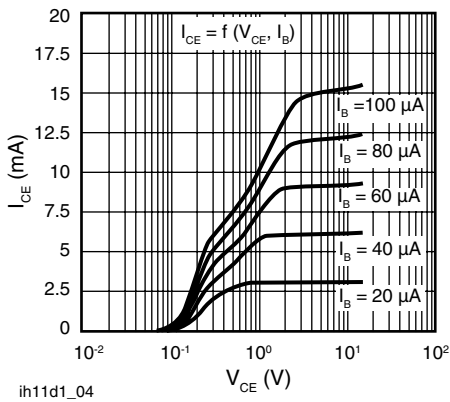

Fig. 3 - Output Characteristics

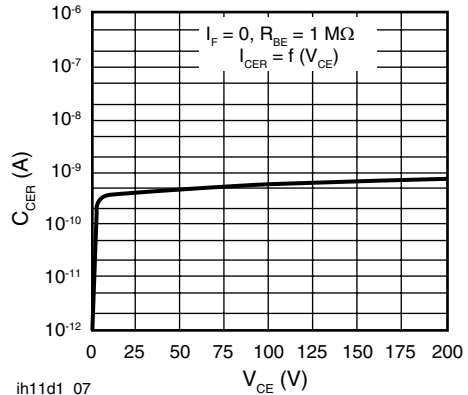
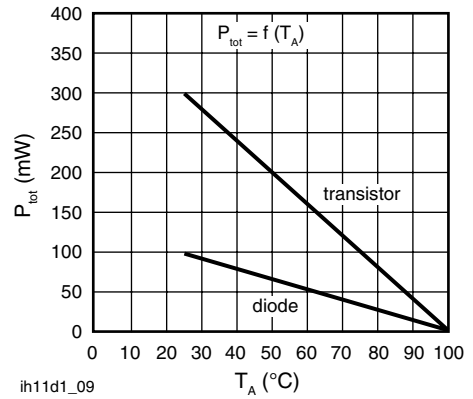

Fig. 6 - Collector Emitter Leakage Current (typ.)



ih11d1_08

Fig. 7 - Permissible Loss Diode



ih11d1_09

Fig. 8 - Permissible Power Dissipation

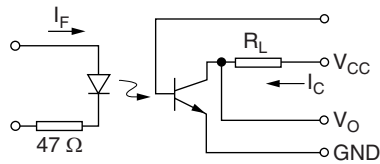

ih11d1_01

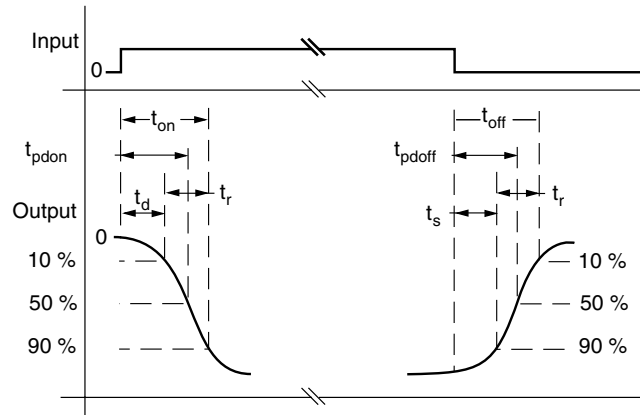

Fig. 9 Switching Times Measurement-Test Circuit and Waveform

H11D1/H11D2/H11D3/H11D4



Vishay Semiconductors Optocoupler, Phototransistor Output,
With Base Connection, High BV_{CER} Voltage

PACKAGE DIMENSIONS in inches (millimeters)

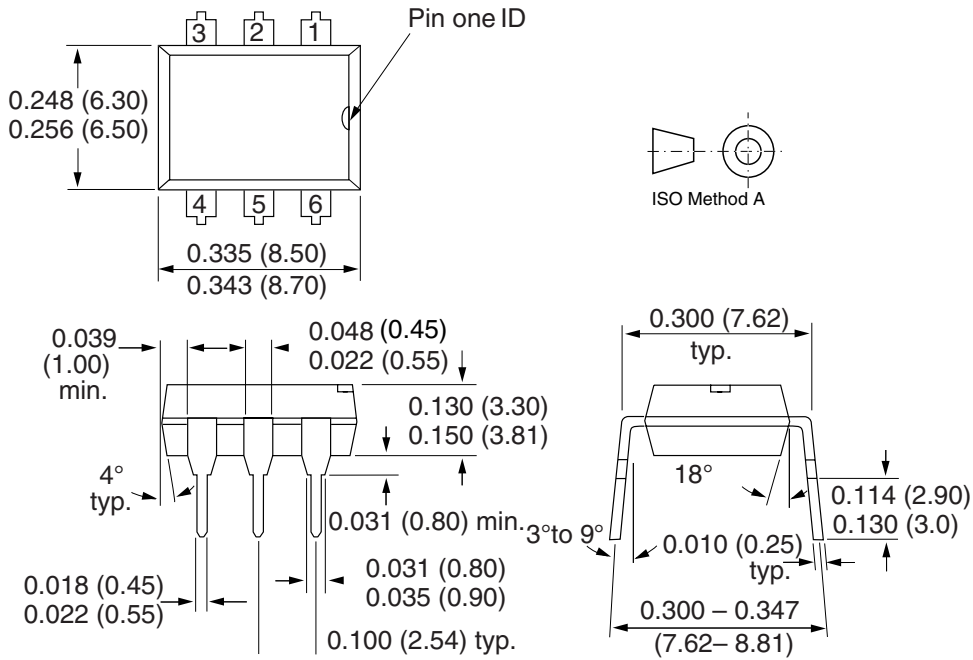

i178004

Option 7

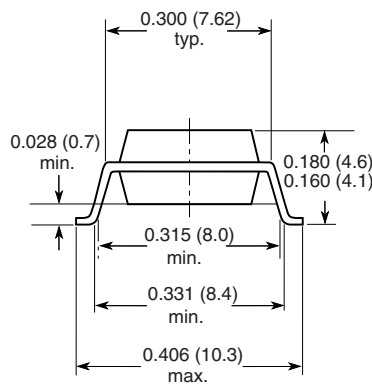

Option 9

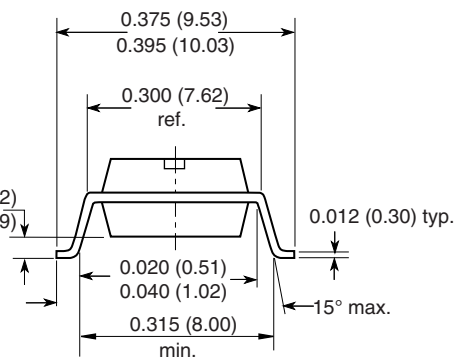

18494



OZONE DEPLETING SUBSTANCES POLICY STATEMENT

It is the policy of Vishay Semiconductor GmbH to

1. Meet all present and future national and international statutory requirements.
2. Regularly and continuously improve the performance of our products, processes, distribution and operating systems with respect to their impact on the health and safety of our employees and the public, as well as their impact on the environment.

It is particular concern to control or eliminate releases of those substances into the atmosphere which are known as ozone depleting substances (ODSs).

The Montreal Protocol (1987) and its London Amendments (1990) intend to severely restrict the use of ODSs and forbid their use within the next ten years. Various national and international initiatives are pressing for an earlier ban on these substances.

Vishay Semiconductor GmbH has been able to use its policy of continuous improvements to eliminate the use of ODSs listed in the following documents.

1. Annex A, B and list of transitional substances of the Montreal Protocol and the London Amendments respectively.
2. Class I and II ozone depleting substances in the Clean Air Act Amendments of 1990 by the Environmental Protection Agency (EPA) in the USA
3. Council Decision 88/540/EEC and 91/690/EEC Annex A, B and C (transitional substances) respectively.

Vishay Semiconductor GmbH can certify that our semiconductors are not manufactured with ozone depleting substances and do not contain such substances.

We reserve the right to make changes to improve technical design
and may do so without further notice.

Parameters can vary in different applications. All operating parameters must be validated for each customer application by the customer. Should the buyer use Vishay Semiconductors products for any unintended or unauthorized application, the buyer shall indemnify Vishay Semiconductors against all claims, costs, damages, and expenses, arising out of, directly or indirectly, any claim of personal damage, injury or death associated with such unintended or unauthorized use.

Vishay Semiconductor GmbH, P.O.B. 3535, D-74025 Heilbronn, Germany



Notice

Specifications of the products displayed herein are subject to change without notice. Vishay Intertechnology, Inc., or anyone on its behalf, assumes no responsibility or liability for any errors or inaccuracies.

Information contained herein is intended to provide a product description only. No license, express or implied, by estoppel or otherwise, to any intellectual property rights is granted by this document. Except as provided in Vishay's terms and conditions of sale for such products, Vishay assumes no liability whatsoever, and disclaims any express or implied warranty, relating to sale and/or use of Vishay products including liability or warranties relating to fitness for a particular purpose, merchantability, or infringement of any patent, copyright, or other intellectual property right.

The products shown herein are not designed for use in medical, life-saving, or life-sustaining applications. Customers using or selling these products for use in such applications do so at their own risk and agree to fully indemnify Vishay for any damages resulting from such improper use or sale.

Компания «Океан Электроники» предлагает заключение долгосрочных отношений при поставках импортных электронных компонентов на взаимовыгодных условиях!

Наши преимущества:

- Поставка оригинальных импортных электронных компонентов напрямую с производств Америки, Европы и Азии, а так же с крупнейших складов мира;
- Широкая линейка поставок активных и пассивных импортных электронных компонентов (более 30 млн. наименований);
- Поставка сложных, дефицитных, либо снятых с производства позиций;
- Оперативные сроки поставки под заказ (от 5 рабочих дней);
- Экспресс доставка в любую точку России;
- Помощь Конструкторского Отдела и консультации квалифицированных инженеров;
- Техническая поддержка проекта, помощь в подборе аналогов, поставка прототипов;
- Поставка электронных компонентов под контролем ВП;
- Система менеджмента качества сертифицирована по Международному стандарту ISO 9001;
- При необходимости вся продукция военного и аэрокосмического назначения проходит испытания и сертификацию в лаборатории (по согласованию с заказчиком);
- Поставка специализированных компонентов военного и аэрокосмического уровня качества (Xilinx, Altera, Analog Devices, Intersil, Interpoint, Microsemi, Actel, Aeroflex, Peregrine, VPT, Syfer, Eurofarad, Texas Instruments, MS Kennedy, Miteq, Cobham, E2V, MA-COM, Hittite, Mini-Circuits, General Dynamics и др.);

Компания «Океан Электроники» является официальным дистрибьютором и эксклюзивным представителем в России одного из крупнейших производителей разъемов военного и аэрокосмического назначения «JONHON», а так же официальным дистрибьютором и эксклюзивным представителем в России производителя высокотехнологичных и надежных решений для передачи СВЧ сигналов «FORSTAR».



JONHON

«JONHON» (основан в 1970 г.)

Разъемы специального, военного и аэрокосмического назначения:

(Применяются в военной, авиационной, аэрокосмической, морской, железнодорожной, горно- и нефтедобывающей отраслях промышленности)

«FORSTAR» (основан в 1998 г.)

ВЧ соединители, коаксиальные кабели, кабельные сборки и микроволновые компоненты:

(Применяются в телекоммуникациях гражданского и специального назначения, в средствах связи, РЛС, а так же военной, авиационной и аэрокосмической отраслях промышленности).



Телефон: 8 (812) 309-75-97 (многоканальный)

Факс: 8 (812) 320-03-32

Электронная почта: ocean@oceanchips.ru

Web: <http://oceanchips.ru/>

Адрес: 198099, г. Санкт-Петербург, ул. Калинина, д. 2, корп. 4, лит. А