



DESIGN GUIDE

VIPAC™



CONTENTS



2 – 3	PRODUCT OVERVIEW
4	FEATURES
5	INPUT / OUTPUT OPTIONS
6	SPECIFICATIONS
7 – 8	TECHNICAL OVERVIEW
9	INPUT CONNECTIONS
10 – 12	OUTPUT CONNECTION OPTIONS
13 – 14	CHASSIS CONFIGURATIONS
15 – 16	MOUNTING OPTIONS
17 – 20	MECHANICAL DRAWINGS
21	MECHANICAL INFORMATION
22	THERMAL MANAGEMENT
23	GENERAL INFORMATION
24	APPLICATION TIPS

PRODUCT OVERVIEW

Vicor's VIPAC™ is an integrated power system leveraging the latest advances in DC-DC converter technology and modular front-ends. VIPAC combines application specific power processing units (PPU), a choice of chassis styles and remotely located hold up capacitors to provide fast, flexible and highly reliable power solutions for a wide range of demanding applications.

The PPU is the core element of the system and may be specified for 115/230 Vac operation. The PPU incorporates Vicor's autoranging FARM modular front-end to provide transient protection, EMI filtering and inrush current limiting. The web-based [PowerBench™](#) enables designers to configure the PPU with up to three independently regulated outputs having power levels from 50 to 500 W and with as much as 900 W total output power. Vicor's Maxi, Mini, Micro Family DC-DC converters, in industry standard quarter, half and full brick packages, are used to deliver output voltages from 2 to 48 Vdc. Additionally, the wide trim range of the modules can provide operating voltages as low as 500 mV.

The PPU is comprised of:

- AC input modular front end
- Vicor's Maxi, Mini, Micro Family high density DC-DC converters
- Coldplate or finned chassis
- Choice of output termination styles

The VIPAC is offered in several chassis configurations facilitating its use in a variety of applications using either conduction, convection or forced convection cooling. The low profile, conduction cooled version may be mounted to an existing cabinet wall, coldplate or heat sink. The 0.5" or 1" finned versions, available in longitudinal or transverse configurations, are ideal for use in free or forced convection environments. The use of standard chassis footprints allows different input voltage configurations of the VIPAC to be used interchangeably depending on system and market requirements.

VIPACs use remotely located capacitors to facilitate packaging and placement options not previously available. The low profile PPU can be placed closer to the load or attached to cabinet walls while the capacitors may be integrated into the host system away from heat sources for improved reliability. System hold up / ride-thru requirements can also be tailored for specific applications via different value capacitors. The hold up capacitors may be obtained from Vicor as a prepackaged hold up box (HUB). VIPAC is a new class of flexible, high density power

solutions.

PPU



HUB





AC Input Autoranging

- 115/230 Vac
- 50/60 Hz (400 Hz optional)



FEATURES

- **Analog User Interface**

- Power Up / Down control
- BUS-OK



- **Partitioned Power Architecture**

- Maximizes packaging flexibility
- Remote hold-up capacitors (AC input)
- User-definable hold-up characteristics (AC input)
- Enhanced reliability
- Wide operating temperature range
 - 20° to +95°C chassis C-Grade
 - 40° to +95°C chassis T-Grade



- **Secondary Control**







- Output voltage trimming
- 10 – 110% Vout



OUTPUT OPTIONS

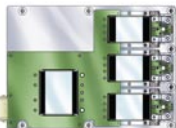

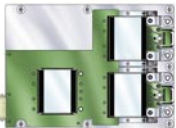
Output Voltage Selection

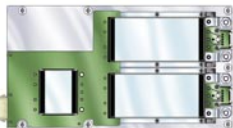
VIPAC Configuration		2 V	3.3 V	5 V	12 V	15 V	24 V	28 V	36 V	48 V	Total
		Micro									
		Maximum Output Power (W)*									
	# Outputs										
VP-G	Single	50	75	100	150	150	150	150	150	150	150
	Single //	100	150	200	300	300	300	300	300	300	300
	Dual	50 50	75 75	100 100	150 150	150 150	150 150	150 150	150 150	150 150	300
	Dual //	100 50	150 75	200 100	300 150	300 150	300 150	300 150	300 150	300 150	450
	Triple	50 50	75 75	100 100	150 150	150 150	150 150	150 150	150 150	150 150	450
		50	75	100	150	150	150	150	150	150	
		Mini									
		Maximum Output Power (W)*									
	# Outputs										
VP-E	Single	100	150	200	250	250	250	250	250	250	250
	Single //	200	300	400	500	500	500	500	500	500	500
	Dual	100 100	150 150	200 200	250 250	250 250	250 250	250 250	250 250	250 250	500
		Maxi									
		Maximum Output Power (W)*									
	# Outputs										
VP-F	Single	160	264	400	500	500	500	500	500	500	500
	Single //	320	528	800	900	900	900	900	900	900	900
	Dual	160 160	264 264	400 400	500 500	500 500	500 500	500 500	500 500	500 500	900

*Model numbers and total output power capability are application specific.
 Component tolerances may effect total output power ($\pm 5\%$) in parallel (//) configurations.
 See VIPAC configuration tool at: vicorpower.com/vcad

SPECIFICATIONS

115/230 Vac Autoranging Input

Parameter	Min	Typ	Max	Unit	Notes
Operating input voltage	90		132	Vac	Autoranging doubler mode
	180		264	Vac	Autoranging bridge mode
Input undervoltage shut down			90	Vac	No damage
AC line frequency	47		63	Hz	C-Grade
	47		440	Hz	T-Grade
Power factor		0.60			Nominal Line
Inrush current			30	Amps	264 Vac peak line, cold start
Input surge withstand	EN61000-4-5				2 kV–50 µs common mode
Performance Criteria B					1 kV–50 µs differential mode
Hold-up capacitance		1,800	3,300	µF	Refer to VCAD calculator
Leakage current			3.2	mA	at 264 Vac input
EMI					Additional filter components are required for compliance to EN55022 and FCC conducted emissions requirements.

Environmental

Parameter	Min	Typ	Max	Unit	Notes
Dielectric withstand	2,121			Vdc	Vdc test recommended due to Y-caps
Input to chassis	1,500			Vrms	Class 1 product. Isolation components tested prior to assembly. Do not test finished product at this value.
Input to output	3,000			Vrms	
Operating temperature – chassis					
C-Grade	-20		95	°C	
T-Grade	-40		95	°C	
Shock	50			g	GR 6063, NEBS, Zone 4 (designed to meet)
Vibration	1			g	GR 6063, NEBS, Zone 4 (designed to meet)
Humidity	5		95	%	Non-condensing
Safety approvals					
cTUVus EN 60950-1,					
UL 60950-1,					
CE Marked (LVD)					

Output Specifications – General at 25°C, nominal line and nominal load, per module unless otherwise specified

Parameter	Min	Typ	Max	Unit	Notes
Output voltage set point			±1	%	Vout nom
Line regulation		±0.02	±0.2	%	Low line to high line; full load
Temperature regulation		±0.002	±0.005	%/°C	Over operating temp. range
Over temperature shut down		115		°C	
Power sharing accuracy		±2	±5	%	10% to 100% of full load
Programming range	10		110	%	Of nominal output voltage. (For trimming below 90% of nominal, a minimum load of 10% of maximum rated power may be required)
Current limit		115		% Iout max.	Output voltage 95% of nominal
Short circuit current		115		% Iout max.	Output voltage <250 mV

See 300 V Maxi, Mini, Micro Family data sheets for detailed module specifications.

Interface Control Functions (See technical description)

Type	Output Enable /Disable	Output Sequencing	Bus OK
Remote	✓	✓	✓

TECHNICAL OVERVIEW

Overview

Vicor's VIPAC offers a 115/230 Vac autoranging input. The front-end section utilizes Vicor's FARM input module to provide EMI filtering, transient protection, inrush current limiting and rectification. The VIPAC has provisions to allow controlling the operation of the individual outputs and providing a BUS OK status indication. Reference the figure below for circuit operation.

Up to three individually fused Maxi, Mini, Micro Family DC-DC converters are combined with the front end in an integrated mechanical – assembly providing a high efficiency power supply delivering up to 900 W of output power.

Circuit Operation

The AC autoranging input VIPAC utilizes the FARM module which provides inrush current limiting, transient protection, EMI filtering and rectification. The AC line voltage is applied via an agency approved 6 pin connector. A fuse in the "L1" lead protects the VIPAC from damage due to internal shorts. At start-up, AC inrush current is limited by a PTC thermistor. The PTC thermistor serves as both an inrush current limiter on power up and a current limiting shut-down device in the event of an input over voltage condition. The PTC is shunted out shortly after initial power up by a DC bus voltage sense circuit. The main energy storage capacitors are located remotely in the HUB (Hold-up Box) or as customer supplied hold-up capacitors. The main rectifiers and filter capacitors act as either a full wave bridge or voltage doubler (depending on the applied AC voltage) delivering a nominal 300 Vdc to one or more Vicor Maxi, Mini, Micro Family DC-DC converters.

The DC-DC converters deliver the selected output voltage and current levels, provide output over voltage protection, output current limiting, voltage regulation, trim capability and input to output isolation.

At initial power up, the front end is configured for 230 Vac operation and the PTC inrush limiter permits the main storage capacitors to charge up at a controlled rate toward full operating DC bus potential. If the bus voltage settles below the operating threshold, the unit will auto-strap for 115 Vac operation. The strapping function is performed by an SCR that configures the front end as either a full wave bridge or a voltage doubler. If the unit is operating in the 115 Vac mode and a long duration transient is applied to the VIPAC (>150 Vac for 50 ms), the unit will auto-strap for 230 Vac operation. Input power must be removed for approximately one minute to restore normal operation from 115 Vac. A control circuit holds the DC-DC converter PC pins low, DC outputs off, the PTC shunt inactive and the BUS-OK output in FAIL status until the DC bus potential reaches a minimum threshold. The PC terminals of all converter modules internal to the VIPAC are FET controlled by a logical replica of the BUS-OK status line, and therefore inhibit converter operation at power up until the DC bus potential has settled to a proper operating level. At this point, the converters are enabled and the PTC shunt activated. A voltage sensing circuit connected across the DC bus performs input over voltage sensing and protection. In the event of an over voltage condition, an SCR/PTC combination will simultaneously disable the DC-DC converters and hold down the DC bus. Normal operation will resume when the input voltage returns within steady-state limits.



BUS-OK

An internal replica of BUS-OK is wired to the PC pin of all internal driver modules. The modules will be disabled (no DC output) during initial power up of the VIPAC until the internal DC input bus voltage to the DC-DC converters is sufficient to support fully-loaded operation. The BUS-OK status output reflects the status of this inhibit function. This same logic circuit will shut down the converters when the internal DC bus voltage is insufficient to support proper loaded operation. This shut down will occur during normal power down, line dropouts of duration exceeding the hold up time, or internal faults causing the internal DC bus voltage at the input of the converters to collapse. The BUS-OK output provide the user with an optically isolated status indication of the internal DC bus. This output, in system applications, can provide power supply status, switch in (standby) backup sources or initiate “power down” sequences to save volatile memory contents in the event of a power loss.

Individual Module Control

Driving the appropriate optocoupler can independently control each DC-DC module within the VIPAC. The minimum optocoupler input current for disabling the supplies is 3 mA. The maximum allowable current is 20 mA. J3 connector pins 1 and 2 always control module 1, pins 3 and 4 always control module 2 (if present) and pins 5 and 6 control module 3 (if present).

Electrical Connections

J3 status output pair BUS-OK+ (PIN 8), BUS-OK- (PIN 7) are the collector (+) and emitter (-) of NPN optocoupler output transistor. The collector terminal BUS-OK+ of the optocoupler, in a typical application, and the drive pin (PIN 10) can be connected via current limiting resistors to an external source no greater than 18 Vdc. These resistors should limit the maximum current to the optocoupler output transistors to 2 mA. The emitter terminal BUS-OK- is connected to the return of the external source.

The status FAULT condition will set the BUS OK optocoupler output transistors in saturation and are capable of sinking up to 1.5 mA with a Vce saturation voltage of 0.4 V. Users should be cautioned that although the output of the VIPAC can be used as the pull up source, shortly after BUS-OK changes from OK (High Z) to NOT OK (Saturated), the pull up voltage will be shut down. It is thus advisable to provide a capacitive reservoir, if the pull up source is one of the VIPAC's outputs, in order to maintain the pull up potential after loss of DC current output. Use edge sensing logic to detect assertion of logic outputs, or a separate source of bias supply voltage (i.e., backup batteries) to provide a safe pull up voltage source regardless of the line status.



INPUT CONNECTIONS

AC Input/V Bus

Conn. Pin# Funct. Mating Conn.

Conn.	Pin#	Funct.	Mating Conn.
J2	1	V Bus+	P/N 22499
	2	Strap	
	3	V Bus-	
	4	L2/N	
	5	L1	
	6	GND ⊕	

I/O Interface*

Conn. Pin# Funct. Mating Conn.

Conn.	Pin#	Funct.	Mating Conn.
J3	1	Module 1 E/D Return	JST 10ZR-3H-P
	2	Module 1 E/D Supply	
	3	Module 2 E/D Return	
	4	Module 2 E/D Supply	
	5	Module 3 E/D Return	
	6	Module 3 E/D Supply	
	7	BUS-OK Status Return	
	8	BUS-OK Status Supply	
	9	N/C	
	10	BUS-OK Drive Input	



OUTPUT CONNECTION OPTIONS

Discrete Output Configurations

LugMate (Factory Installed Option)

Micro LugMate



Ring Lugs



#4-40 Torque 4 in. lbs.

LugMate Pin Out

Pin #	Solder Pad	Function
1		- Vout
	Rd	Trim-Down
	SC	Secondary Control
	Ru	Trim-Up
3		+ Vout

Micro LugMate - with Rd/Ru trim resistor solder pads. (Design calculator for trim resistors located at vicorpower.com)



Mini/Maxi LugMate

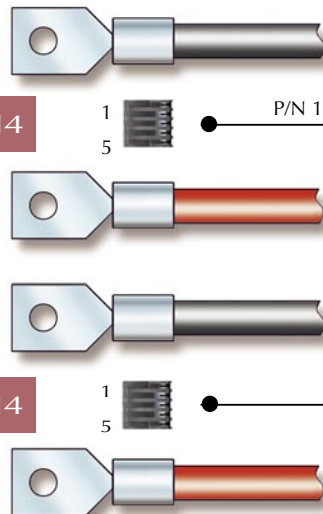

#10-32 Torque 16 in. lbs.

Pin #	Conn.	Function	Mating Conn.
1		- Vout	
	J4-1	- Vout	P/N 16385
	J4-2	- Sense	
	J4-3	Secondary Control	
	J4-4	+ Sense	
	J4-5	+ Vout	
5		+ Vout	

*Removable jumper is factory installed for local sensing. See Pg 24 for details

OUTPUT CONNECTION OPTIONS

Parallel Output Configurations Shown with the output of two modules connected in parallel using BUS BARS.

LugMate (Factory Installed Option)



Ring Lugs

LugMate Pin Out

Pin #	Solder Pad	Function
1		- Vout
	Rd	Trim-Down
	SC	Secondary Control
	Ru	Trim-Up
3		+ Vout

Micro LugMate - with Rd/Ru trim resistor solder pads. (Design calculator for trim resistors located at vicorpower.com)



Mini/Maxi LugMate

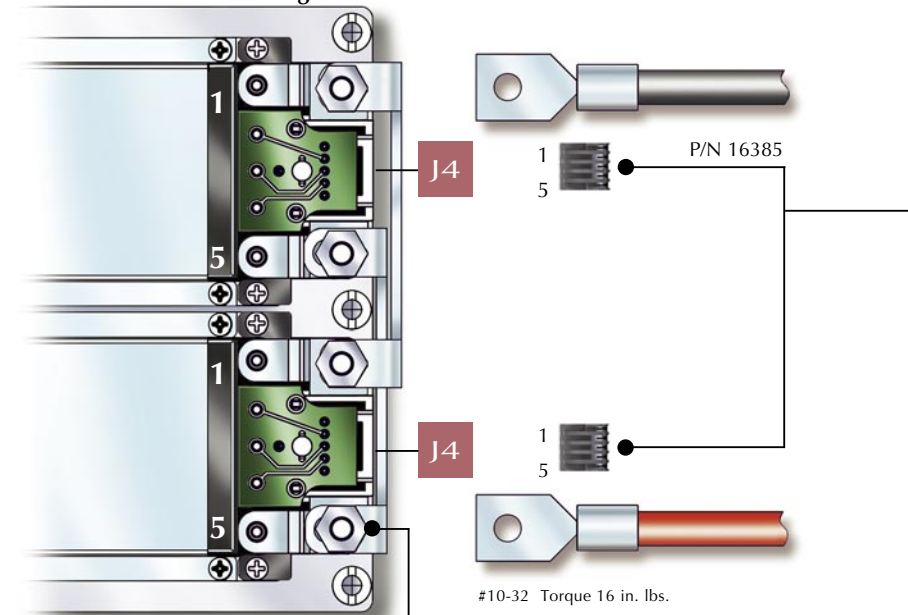

Pin #	Conn.	Function	Mating Conn.
1		- Vout	
	J4-1	- Vout	P/N 16385
	J4-2	- Sense	
	J4-3	Secondary Control	
	J4-4	+ Sense	
	J4-5	+ Vout	
5		+ Vout	

*Removable jumper is factory installed for local sensing. In using 2 modules configured as a single output as illustrated, one module must be dedicated as a master, or the sense lines must be terminated to the same point physically to their respective output.

OUTPUT CONNECTION OPTIONS

PlugMate

(Factory Installed Option)

Micro PlugMate



Vicor kit P/N 25073



PlugMate Pin Out

(Looking into PlugMate)

1		4
5		8

Pin #	Function	Pin #	Function
1	+Vout	5	+Vout
2	+Vout	6	N/C
3	-Vout	7	SC
4	-Vout	8	-Vout

Mating Connector	TE Connectivity P/N	Vicor P/N
Housing	TYC-794657-8	
Pin	1-106529-2	
Kit		25073

Mini PlugMate



Vicor kit P/N 25067



1						9
10						18

Pin #	Function	Pin #	Function
1	+Vout	10	+Vout
2	+Vout	11	+Vout
3	+Vout	12	+Vout
4	N/C	13	+S
5	N/C	14	SC
6	N/C	15	-S
7	-Vout	16	-Vout
8	-Vout	17	-Vout
9	-Vout	18	-Vout

Mating Connector	TE Connectivity P/N	Vicor P/N
Housing	TYC1-794657-8	
Pin	1-106529-2	
Kit		25067

Maxi PlugMate



Vicor kit P/N 25061



1										12
13										24

Pin #	Function	Pin #	Function
1	+Vout	13	+Vout
2	+Vout	14	+Vout
3	+Vout	15	+Vout
4	+Vout	16	+Vout
5	+Vout	17	+Vout
6	N/C	18	+S
7	SC	19	-S
8	-Vout	20	-Vout
9	-Vout	21	-Vout
10	-Vout	22	-Vout
11	-Vout	23	-Vout
12	-Vout	24	-Vout

Mating Connector	TE Connectivity P/N	Vicor P/N
Housing	TYC2-794657-4	
Pin	1-106529-2	
Kit		25061

Note:

VIPACs that contain multiple modules configured as a single output (paralleled for power or redundancy) **MUST** have their Outputs and Sense connected to each other at the load. **DO NOT OPERATE A PARALLEL CONFIGURATION WITH ONLY ONE MODULE CONNECTED.**

CHASSIS CONFIGURATIONS



VP-A

3 MICRO

- 4.96" x 6.8" (126,0 x 172,7 mm)
- Dual or Triple Output
- Up to 450 W
- Up to 75 A



VP-C

2 MAXI

- 4.96" x 9.15" (126,0 x 232,4 mm)
- Single or Dual Output
- Up to 900 W
- Up to 160 A



VP-B

2 MINI

- 4.96" x 6.8" (126,0 x 172,7 mm)
- Single or Dual Output
- Up to 500 W
- Up to 100 A



VP-D

2 MICRO

- 3.15" x 6.8" (80,0 x 172,7 mm)
- Single or Dual Output
- Up to 300 W
- Up to 50 A

CHASSIS CONFIGURATIONS

Finned Chassis Configurations



VP-E

1 MINI

- 3.15" x 6.8" (80,0 x 172,7 mm)
- Single Output
- Up to 250 W



VP-F

1 MAXI

- 3.15" x 9.15" (80,0 x 232,4 mm)
- Single Output
- Up to 500 W
- Up to 80 A



VP-G

1 MICRO

- 3.15" x 6.8" (80,0 x 172,7 mm)
- Single Output
- Up to 150 W
- Up to 25 A



Coldplate



Optional 0.5" Fin



Optional 1" Fin



Longitudinal



Transverse

MOUNTING OPTIONS

Thru Hole Mounting



Surface Mounting



VIPAC with integral finned heat sink thru hole mounted



VIPAC with external user supplied heat sink



MOUNTING OPTIONS



For proper clearance use:

Long standoff (P/N 23709R) for mounting 1" heat sink fins down.

Short standoff (P/N 23710R) for mounting 0.5" heat sink fins down or either heat sink fins up.



MECHANICAL DRAWINGS



Configuration VP-A



Configuration VP-B



Torque in. / lbs.	Feature	MOUNTING			Max. Chassis Temp.
		Locations indicated by	Type	Quantity of holes provided for VIPAC Model Configuration	
12	Coldplate (Thermal interface material required)	⊙ ●	Clearance holes for 8-32 90 CS to .30	6 6 6 5 6 6 6 VP - A B C D E F G	95°C
	Finned heat sink	⊙	threaded thru hole for 8-32	6 6 6 5 6 6 6 VP - A B C D E F G	95°C
4 16	Micro Lugmate Mini/Maxi Lugmates				

All dimensions are $\frac{\text{in}}{\text{mm}}$

MECHANICAL DRAWINGS

Configuration VP-C



Configuration VP-D



Torque in. / lbs.	Feature	MOUNTING		Max. Chassis Temp.	
		Locations indicated by	Type		Quantity of holes provided for VIPAC Model Configuration
	Coldplate (Thermal interface material required)	⊙ ●	Clearance holes for 8-32 90 CS to .30	VP - 6 6 6 5 6 6 6 A B C D E F G	95°C
12	Finned heat sink	⊙	threaded thru hole for 8-32	VP - 6 6 6 5 6 6 6 A B C D E F G	95°C
4 16	Micro Lugmate Mini/Maxi Lugmates				

All dimensions are $\frac{\text{in}}{\text{mm}}$

MECHANICAL DRAWINGS



Configuration VP-E

LugMates



PlugMates



Configuration VP-F

LugMates



PlugMates



Torque in. / lbs.	Feature	MOUNTING			Max. Chassis Temp.
		Locations indicated by	Type	Quantity of holes provided for VIPAC Model Configuration	
	Coldplate (Thermal interface material required)	⊙ ●	Clearance holes for 8-32 90 CS to .30	VP - 6 6 6 5 6 6 6 A B C D E F G	95°C
12	Finned heat sink	⊙	threaded thru hole for 8-32	VP - 6 6 6 5 6 6 6 A B C D E F G	95°C
4 16	Micro Lugmate Mini/Maxi Lugmates				

All dimensions are $\frac{\text{in}}{\text{mm}}$

MECHANICAL DRAWINGS

Configuration VP-G

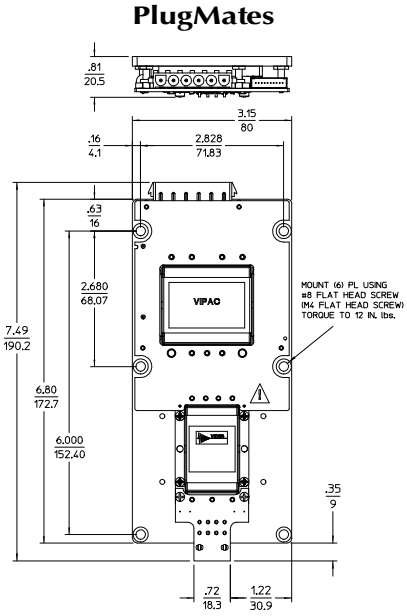

Torque in. / lbs.	Feature	MOUNTING			Max. Chassis Temp.
		Locations indicated by	Type	Quantity of holes provided for VIPAC Model Configuration	
	Coldplate (Thermal interface material required)	⊙ ●	Clearance holes for 8-32 90 CS to .30	VP - 6 6 6 5 6 6 6 A B C D E F G	95°C
12	Finned heat sink	⊙	threaded thru hole for 8-32	VP - 6 6 6 5 6 6 6 A B C D E F G	95°C
4 16	Micro Lugmate Mini/Maxi Lugmates				

All dimensions are $\frac{\text{in}}{\text{mm}}$

Heat Sink Options



Coldplate



0.5" Fin Option



1" Fin Option

Fin spacing and relief
are the same for both Fin options.

MECHANICAL INFORMATION



VIPAC Product Weight

VIPAC Model Prefix	Chassis Configuration	Chassis Configuration					
		Coldplate		0.5" Fins		1" Fins	
		Pounds	Grams	Pounds	Grams	Pounds	Grams
VP-G	1 Micro	0.9	411	1.4	640	1.6	731
VP-D	2 Micro	1.0	457	1.5	686	1.7	777
VP-A	3 Micro	1.4	640	2.2	1006	2.5	1143
VP-E	1 Mini	1.0	457	1.4	640	1.6	731
VP-B	2 Mini	1.4	640	2.2	1006	2.6	1189
VP-F	1 Maxi	1.3	594	2.0	914	2.3	1051
VP-C	2 Maxi	2.2	1006	3.0	1371	3.5	1600

VIPAC Standoff Mounting Kits

Vicor Kit P/N	Kit Description	For use with:
23709R	Qty. 6 – #23655 long standoff	1" finned heat sinks
23710R	Qty. 6 – #23656 short standoff	1/2" finned heat sinks or coldplate

Hold-up Box (HUB)



Top view, HUB



Description*	Height		Weight		Part Number
	(Inches ±.06")	(mm)	Ounces	Grams	
820 µF	1.55	39,4	3.95	112	HUB820-S
1200 µF	1.75	44,5	4.85	137	HUB1200-S
1800 µF	2.14	54,4	6.11	173	HUB1800-S
2200 µF	2.85	72,4	7.44	211	HUB2200-S
2700 µF	3.52	89,4	8.70	247	HUB2700-S
3300 µF	3.52	89,4	9.38	266	HUB3300-S

* Each HUB contains two (2) capacitors of the value shown.

Maximum cable length between the HUB and VIPAC ≤ 3'

THERMAL MANAGEMENT

Thermal Impedance Specifications (°C/W)

VIPAC Model Prefix	Chassis Config.	Heat Sink	Natural Convection	Airflow					
				200 (LFM)	400 (LFM)	600 (LFM)	800 (LFM)	1000 (LFM)	1200 (LFM)
VP-A	3 Micro	0.5" L	1.98	0.77	0.53	0.45	0.39	0.36	0.33
		0.5" T	1.71	0.68	0.48	0.40	0.36	0.33	0.30
		1.0" L	1.68	0.58	0.42	0.36	0.32	0.30	0.28
		1.0" T	1.27	0.46	0.33	0.28	0.25	0.23	0.21
VP-B	2 Mini	0.5" L	1.90	0.77	0.53	0.44	0.39	0.36	0.33
		0.5" T	1.67	0.69	0.48	0.41	0.37	0.33	0.31
		1.0" L	1.49	0.54	0.39	0.34	0.31	0.28	0.27
		1.0" T	1.22	0.47	0.33	0.28	0.25	0.23	0.21
VP-C	2 Maxi	0.5" L	1.50	0.62	0.42	0.35	0.31	0.28	0.25
		0.5" T	1.19	0.52	0.36	0.31	0.27	0.25	0.23
		1.0" L	1.17	0.43	0.31	0.27	0.24	0.22	0.20
		1.0" T	0.86	0.35	0.25	0.21	0.19	0.17	0.16
VP-D	2 Micro	0.5" L	3.13	1.28	0.89	0.74	0.66	0.59	0.54
		0.5" T	2.40	1.02	0.73	0.63	0.56	0.51	0.47
		1.0" L	2.81	0.97	0.70	0.60	0.54	0.50	0.46
		1.0" T	1.87	0.75	0.55	0.47	0.42	0.39	0.35
VP-E	1 Mini	0.5" L	3.11	1.26	0.88	0.74	0.65	0.59	0.54
		0.5" T	2.39	1.01	0.73	0.62	0.56	0.51	0.47
		1.0" L	2.51	0.87	0.64	0.56	0.51	0.48	0.45
		1.0" T	1.76	0.70	0.52	0.44	0.40	0.37	0.33
VP-F	1 Maxi	0.5" L	2.42	1.02	0.69	0.57	0.50	0.45	0.41
		0.5" T	1.72	0.77	0.55	0.47	0.42	0.38	0.37
		1.0" L	2.01	0.72	0.52	0.45	0.41	0.38	0.36
		1.0" T	1.26	0.53	0.38	0.33	0.29	0.27	0.25
VP-G	1 Micro	0.5" L	3.13	1.28	0.89	0.74	0.66	0.59	0.54
		0.5" T	2.40	1.02	0.73	0.63	0.56	0.51	0.47
		1.0" L	2.81	0.97	0.70	0.60	0.54	0.50	0.46
		1.0" T	1.87	0.75	0.55	0.47	0.42	0.39	0.35

GENERAL INFORMATION



Suggested Wire Gauge

Function	Wire Gauge	Application
AC Input Leads	#14	All AC and earth GND ⊕ leads (VIPAC power systems)
DC Output Leads	#20	0 A – 3 A
	#18	4 A – 6 A
	#16	7 A – 10 A
	#14	11 A – 15 A
	#12	16 A – 25 A
	#10	26 A – 40 A
	#8	41 A – 65 A
	#6	66 A – 104 A
	#4	105 A – 160 A

Mating Connector Cross Reference

Designator	Description	Manufacturer	Part Number	
			Pin	Housing
J2	VIPAC AC Input - 6 Pin	TE Connectivity	350551-1	640585-1
J3	VIPAC I/O Interface - 10 Pin	JST	10ZR-3H or 10ZR-3H-P	
J4	VIPAC Output Control - 5 Pin	TE Connectivity	MTA100-IDC644083-5	
	HUB 820-S, 1200-S, 1800-S 3 Pin	TE Connectivity	770248-1	770018-1
	HUB 2200-S, 2700-S, 3300-S 3 Pin	TE Connectivity	193842-1	770018-1
	Micro PlugMate mating connector - 8 pin	TE Connectivity	1-106529-2	TYC-794657-8
	Mini PlugMate mating connector - 18 pin	TE Connectivity	1-106529-2	TYC1-794657-8
	Maxi PlugMate mating connector - 24 pin	TE Connectivity	1-106529-2	TYC2-794657-4

APPLICATION TIPS

Selecting Heat Sinks

VIPAC Power Systems are rated for a maximum chassis temperature of 95°C. Operation within these limits is essential for long life and users should select an appropriate thermal management system. The thermal performance of a particular VIPAC chassis configuration can be approximated from the thermal resistance of the chassis, ambient operating temperature and total power dissipation, using a few simple formulas shown below.

Thermal Resistance: Refer to pg 22

Power Dissipation: Calculated as: $(P_{out} / \text{Efficiency}) - P_{out}$

Example:

Verify a 500 W, 28 Vdc output VIPAC does not exceed 95°C chassis temperature (Tc).

- VP-C chassis configuration with 1" transverse heat sink is selected and 200 lfm airflow is provided.
- Thermal resistance (θ) of 0.35°C/W is obtained from the chart on pg 22.
- Ambient operating temperature (TA) specified by the user is 40°C.
- VIPAC Power System efficiency (η) is 80% overall.

Formula:

$$\begin{aligned} T_c &= \left(\left(\frac{P_{out}}{\eta} - P_{out} \right) \times \theta \right) + T_A \\ &= \left(\left(\frac{500}{0.8} - 500 \right) \times 0.35 \right) + 40 \\ &= 83.75^\circ\text{C} \end{aligned}$$

Conclusion:

This VIPAC will operate in the conditions specified and not exceed maximum chassis temperature.

Comment:

Efficiency of a particular VIPAC will depend on the specific output voltages and operating load conditions. In general the efficiency of VIPACs with outputs of 5 Vdc or less is approximately 70% and those with outputs greater than 5 Vdc is 80%. A more accurate calculation can be derived by summing dissipation of each DC-DC converter module used in the VIPAC and the front-end section of the VIPAC (using 95% efficiency for the front-end).

VIPAC Power System Dissipation

$$P_{diss} = \sum_{1-n} \frac{P_{out}(n)}{\frac{\eta(n)}{0.95}} - P_{out}(n)$$

Remote Sense

A remote sense feature is provided on outputs configured with Mini or Maxi sized DC-DC converters. The output sense connections must be terminated either locally or remotely and may not be left open. **The sense lines for VIPACs configured with a single paralleled output must be terminated to the same point.** VIPACs provided with the optional LugMate connectors are configured for local sensing via removable jumpers installed at the factory. The jumpers will need to be removed if access to the secondary control function is made via mating connector P/N 16385 and connections will need to be established for local or remote sensing.

Hold up Capacitors

Hold up capacitors can be located remotely with up to 3' of cable. Vicor applications engineering should be consulted for projects requiring greater separation.

Wire Routing

Avoid routing wires over VIPAC Power System. Do not bundle Input and Output leads together.

Crimping Tool

Amp Hand Tool P/N	Die Set #	Wire Size
91508-1		20-18 AWG
91506-1		16-14 AWG
69710-1	58380-1	12 AWG
	58380-2	10 AWG

Parallel Outputs

The VIPAC can be configured with parallel modules for increased power or redundancy. When used for increased power, short the SC pin to –Sense on one module. This configures the module as a Booster. The user must properly connect the output and sense terminals (See above).

At no time operate a paralleled output with a load applied only to one module! (See Output Connection Options)

TECHNICAL SUPPORT CONTACTS

For a complete and updated list of contacts visit Vicor at:

http://www.vicorpower.com/contact-us?selectedTab=%23contact_tab2

*Information furnished by Vicor is believed to be accurate and reliable. However, no responsibility is assumed by Vicor for its use. No license is granted by implication or otherwise under any patent or patent rights of Vicor. Vicor components are not designed to be used in applications, such as life support systems, wherein a failure or malfunction could result in injury or death. All sales are subject to Vicor's Terms and Conditions of Sale, which are available upon request. No user serviceable components, contact Vicor to arrange for repair or replacement. **Specifications are subject to change without notice.***

Mouser Electronics

Authorized Distributor

Click to View Pricing, Inventory, Delivery & Lifecycle Information:

Vicor:

[VP-C2209316](#) [VP-F2839235](#) [VP-E2935648E](#) [VP-F2334010](#) [VP-D2935653E](#) [VP-C2104853](#) [VP-D2103629](#) [VP-F2417426E](#) [VP-G3236413E](#) [VP-D2927817](#) [VP-D1798791E](#) [VP-C2432694](#) [VP-A1432187E](#) [VP-D2469630E](#) [VP-E2272622E](#) [VP-C2715222](#) [VP-F1415375E](#) [VP-G2084219](#) [VP-D1782197](#) [VP-C3208827](#) [VP-F2445412](#) [VP-D2619045](#) [VP-D2757628](#) [VP-G2291118](#) [VP-D2802237E](#) [VP-A3210010](#) [VP-G2341213](#) [VP-D2635020](#) [VP-E3011216](#) [VP-E1907997](#) [VP-G2754210](#) [VP-A2655010E](#) [VP-A2864277E](#) [VP-B2539214E](#) [VP-A3080210](#) [VP-B2957011](#) [VP-B2749706E](#) [VP-G2523016](#) [VP-C2812451E](#) [VP-D2217414](#) [VP-D1968787](#) [VP-A2527027E](#) [VP-F2039586](#) [VP-F1845809](#) [VP-B3113839E](#) [VP-D2384256](#) [VP-B2384829E](#) [VP-E2164833](#) [VP-F1598600E](#) [VP-F2599124E](#) [VP-G1911988](#) [VP-C2913019E](#) [VP-D2767630E](#) [VP-E2777267E](#) [VP-E2089596](#) [VP-G2346282](#) [VP-A2556472](#) [VP-A2815415E](#) [VP-B2831230E](#) [VP-C2319622](#) [VP-F3008813E](#) [VP-A2308410E](#) [VP-D1925988](#) [VP-E2434907E](#) [VP-A3097438](#) [VP-A2286523](#) [VP-D2415428E](#) [VP-A2296491](#) [VP-G2989015E](#) [VP-A2776023E](#) [VP-D2098219](#) [VP-A2729221](#) [VP-F2415455](#) [VP-D3109427E](#) [VP-F1904992](#) [VP-F2296528](#) [VP-F1792383](#) [VP-C1762582E](#) [VP-E2454810](#) [VP-F2376239](#) [VP-D1722588](#) [VP-G2592763E](#) [VP-F3207617](#) [VP-B2881055](#) [VP-G2107622](#) [VP-C2863231](#) [VP-B1680391](#) [VP-C2629447](#) [VP-B2301059E](#) [VP-E3054419E](#) [VP-D2735227](#) [VP-C2135448](#) [VP-A2123840](#) [VP-E2305426E](#) [VP-C2596826](#) [VP-A2197011E](#) [VP-E2171064](#) [VP-F2610881E](#) [VP-E2094819E](#) [VP-D2863685E](#)

Компания «Океан Электроники» предлагает заключение долгосрочных отношений при поставках импортных электронных компонентов на взаимовыгодных условиях!

Наши преимущества:

- Поставка оригинальных импортных электронных компонентов напрямую с производств Америки, Европы и Азии, а так же с крупнейших складов мира;
- Широкая линейка поставок активных и пассивных импортных электронных компонентов (более 30 млн. наименований);
- Поставка сложных, дефицитных, либо снятых с производства позиций;
- Оперативные сроки поставки под заказ (от 5 рабочих дней);
- Экспресс доставка в любую точку России;
- Помощь Конструкторского Отдела и консультации квалифицированных инженеров;
- Техническая поддержка проекта, помощь в подборе аналогов, поставка прототипов;
- Поставка электронных компонентов под контролем ВП;
- Система менеджмента качества сертифицирована по Международному стандарту ISO 9001;
- При необходимости вся продукция военного и аэрокосмического назначения проходит испытания и сертификацию в лаборатории (по согласованию с заказчиком);
- Поставка специализированных компонентов военного и аэрокосмического уровня качества (Xilinx, Altera, Analog Devices, Intersil, Interpoint, Microsemi, Actel, Aeroflex, Peregrine, VPT, Syfer, Eurofarad, Texas Instruments, MS Kennedy, Miteq, Cobham, E2V, MA-COM, Hittite, Mini-Circuits, General Dynamics и др.);

Компания «Океан Электроники» является официальным дистрибьютором и эксклюзивным представителем в России одного из крупнейших производителей разъемов военного и аэрокосмического назначения «JONHON», а так же официальным дистрибьютором и эксклюзивным представителем в России производителя высокотехнологичных и надежных решений для передачи СВЧ сигналов «FORSTAR».



JONHON

«JONHON» (основан в 1970 г.)

Разъемы специального, военного и аэрокосмического назначения:

(Применяются в военной, авиационной, аэрокосмической, морской, железнодорожной, горно- и нефтедобывающей отраслях промышленности)

«FORSTAR» (основан в 1998 г.)

ВЧ соединители, коаксиальные кабели,
кабельные сборки и микроволновые компоненты:

(Применяются в телекоммуникациях гражданского и специального назначения, в средствах связи, РЛС, а так же военной, авиационной и аэрокосмической отраслях промышленности).



Телефон: 8 (812) 309-75-97 (многоканальный)

Факс: 8 (812) 320-03-32

Электронная почта: ocean@oceanchips.ru

Web: <http://oceanchips.ru/>

Адрес: 198099, г. Санкт-Петербург, ул. Калинина, д. 2, корп. 4, лит. А