

High Efficiency LED, \varnothing 5 mm Untinted Non-Diffused

Color	Type	Technology	Angle of Half Intensity $\pm\varphi$
Yellow	TLHY5800	GaAsP on GaP	4°
Green	TLHG5800	GaP on GaP	4°
Pure green	TLHP5800	GaP on GaP	4°

Description

The TLH.5800 series was developed for standard applications which need a very small radiation angle or a very high luminous intensity.

It is housed in a 5 mm untinted non-diffused plastic package. The very small viewing angle of these devices provide a very high luminous intensity.

The yellow and green LEDs are categorized in luminous intensity and additionally in wavelength groups.

That allows users to assemble LEDs with uniform appearance.

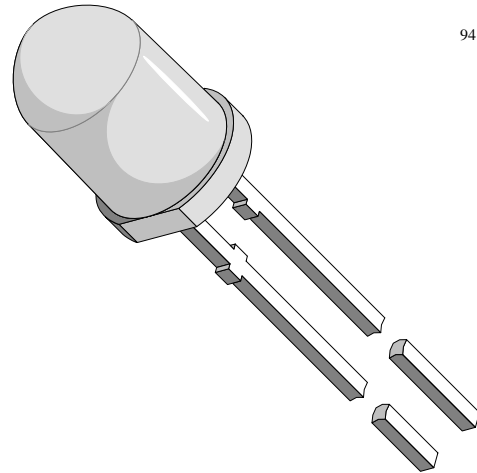

94 8631

Features

- Standard T-1 $\frac{3}{4}$ package
- Small mechanical tolerances
- Suitable for DC and high peak current
- Very small viewing angle
- Very high intensity
- Luminous intensity categorized
- Yellow and green color categorized

Applications

Status lights
 OFF / ON indicator
 Lightpipe
 Outdoor display
 Medical instruments
 Maintenance lights
 Legend lights

Absolute Maximum Ratings

$T_{amb} = 25^{\circ}\text{C}$, unless otherwise specified

TLHY5800, TLHG5800, TLHP5800,

Parameter	Test Conditions	Symbol	Value	Unit
Reverse voltage		V_R	6	V
DC forward current	$T_{amb} \leq 65^{\circ}\text{C}$	I_F	30	mA
Surge forward current	$t_p \leq 10 \mu\text{s}$	I_{FSM}	1	A
Power dissipation	$T_{amb} \leq 65^{\circ}\text{C}$	P_V	100	mW
Junction temperature		T_j	100	$^{\circ}\text{C}$
Operating temperature range		T_{amb}	-20 to +100	$^{\circ}\text{C}$
Storage temperature range		T_{stg}	-55 to +100	$^{\circ}\text{C}$
Soldering temperature	$t \leq 5 \text{ s}$, 2 mm from body	T_{sd}	260	$^{\circ}\text{C}$
Thermal resistance junction/ambient		R_{thJA}	350	K/W

Optical and Electrical Characteristics

$T_{amb} = 25^{\circ}\text{C}$, unless otherwise specified

Yellow (TLHY5800)

Parameter	Test Conditions	Type	Symbol	Min	Typ	Max	Unit
Luminous intensity	$I_F = 20 \text{ mA}$, $I_{Vmin}/I_{Vmax} \geq 0.5$		I_V	100	250		mcd
Dominant wavelength	$I_F = 10 \text{ mA}$		λ_d	581		594	nm
Peak wavelength	$I_F = 10 \text{ mA}$		λ_p		585		nm
Angle of half intensity	$I_F = 10 \text{ mA}$		ϕ		± 4		deg
Forward voltage	$I_F = 20 \text{ mA}$		V_F		2.4	3	V
Reverse voltage	$I_R = 10 \mu\text{A}$		V_R	6	15		V
Junction capacitance	$V_R = 0$, $f = 1 \text{ MHz}$		C_j		50		pF

Green (TLHG5800)

Parameter	Test Conditions	Type	Symbol	Min	Typ	Max	Unit
Luminous intensity	$I_F = 20 \text{ mA}$, $I_{Vmin}/I_{Vmax} \geq 0.5$		I_V	400	700		mcd
Dominant wavelength	$I_F = 10 \text{ mA}$		λ_d	562		575	nm
Peak wavelength	$I_F = 10 \text{ mA}$		λ_p		565		nm
Angle of half intensity	$I_F = 10 \text{ mA}$		ϕ		± 4		deg
Forward voltage	$I_F = 20 \text{ mA}$		V_F		2.4	3	V
Reverse voltage	$I_R = 10 \mu\text{A}$		V_R	6	15		V
Junction capacitance	$V_R = 0$, $f = 1 \text{ MHz}$		C_j		50		pF

Pure green (TLHP5800)

Parameter	Test Conditions	Type	Symbol	Min	Typ	Max	Unit
Luminous intensity	$I_F = 20 \text{ mA}$, $I_{V\min}/I_{V\max} \geq 0.5$		I_V	25	85		mcd
Dominant wavelength	$I_F = 10 \text{ mA}$		λ_d	555		565	nm
Peak wavelength	$I_F = 10 \text{ mA}$		λ_p		555		nm
Angle of half intensity	$I_F = 10 \text{ mA}$		ϕ		± 4		deg
Forward voltage	$I_F = 20 \text{ mA}$		V_F		2.4	3	V
Reverse voltage	$I_R = 10 \mu\text{A}$		V_R	6	15		V
Junction capacitance	$V_R = 0$, $f = 1 \text{ MHz}$		C_j		50		pF

Typical Characteristics ($T_{\text{amb}} = 25^\circ\text{C}$, unless otherwise specified)

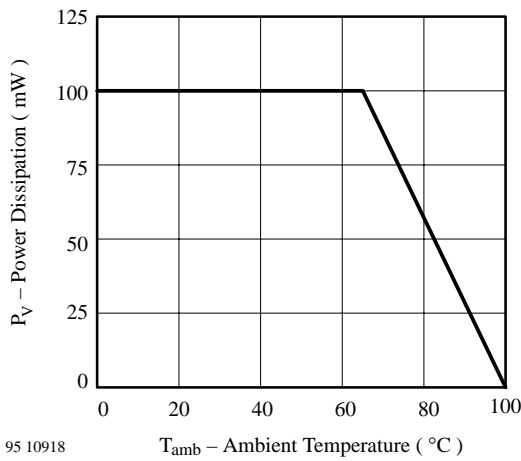

Figure 1 Power Dissipation vs. Ambient Temperature

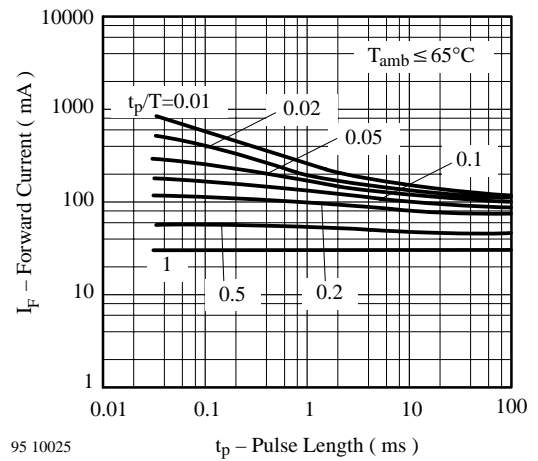

Figure 3 Forward Current vs. Pulse Length

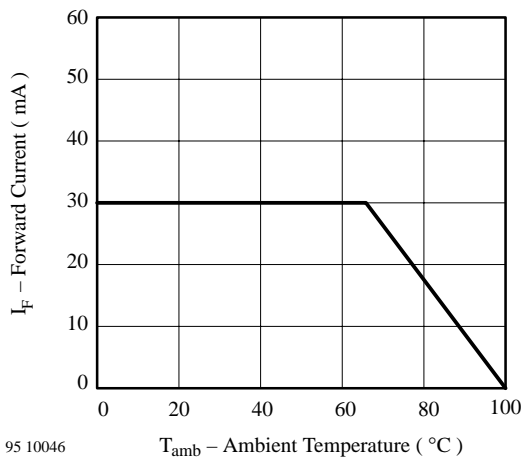

Figure 2 Forward Current vs. Ambient Temperature

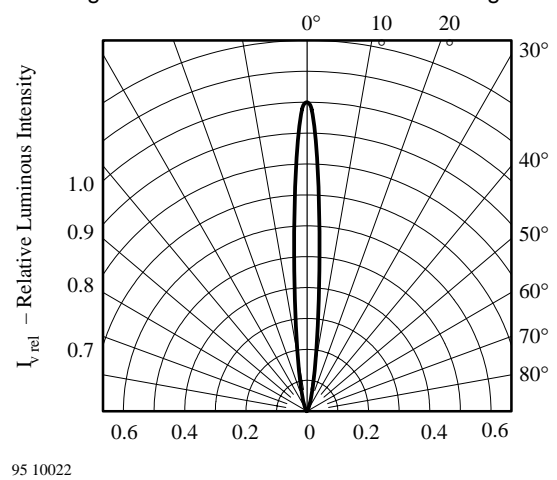

Figure 4 Rel. Luminous Intensity vs. Angular Displacement

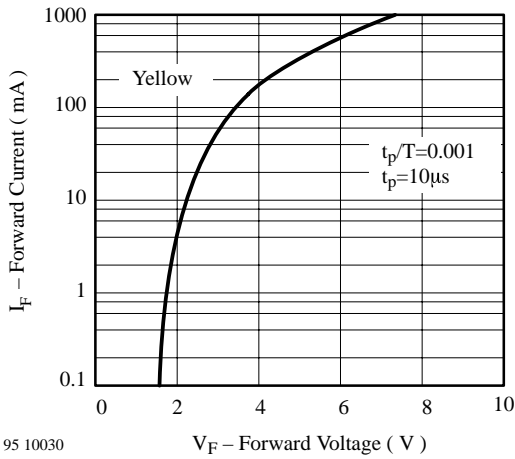

Figure 5 Forward Current vs. Forward Voltage

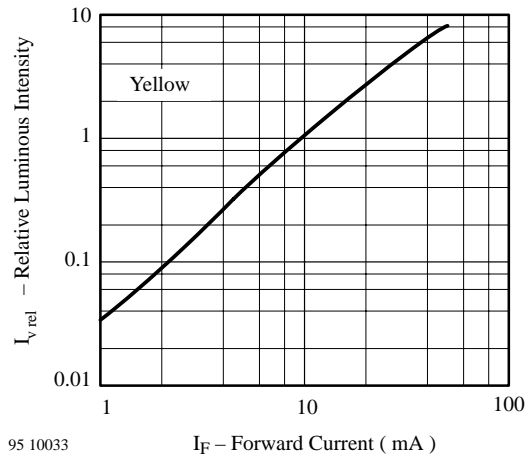

Figure 8 Relative Luminous Intensity vs. Forward Current

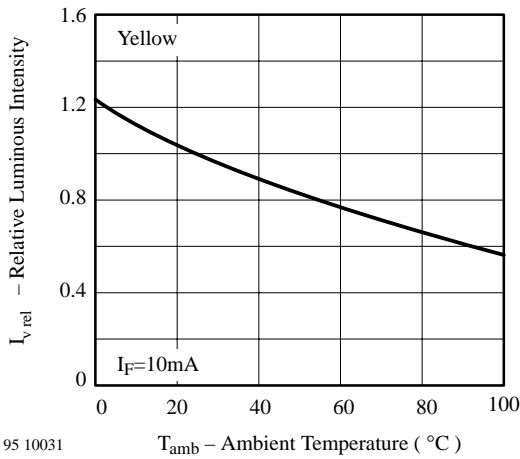

Figure 6 Rel. Luminous Intensity vs. Ambient Temperature

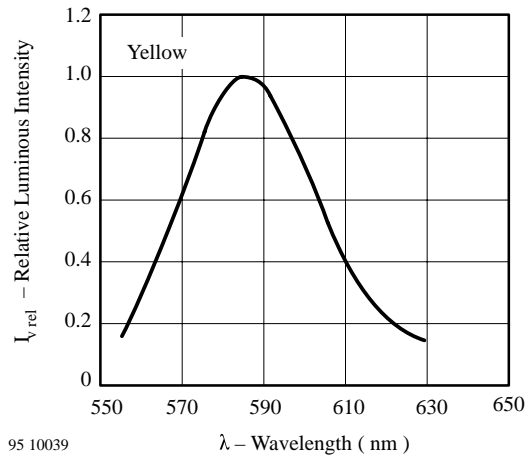

Figure 9 Relative Luminous Intensity vs. Wavelength

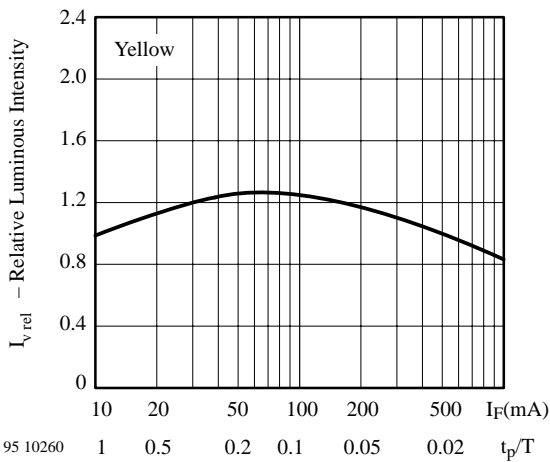

Figure 7 Rel. Lumin. Intensity vs. Forw. Current/Duty Cycle

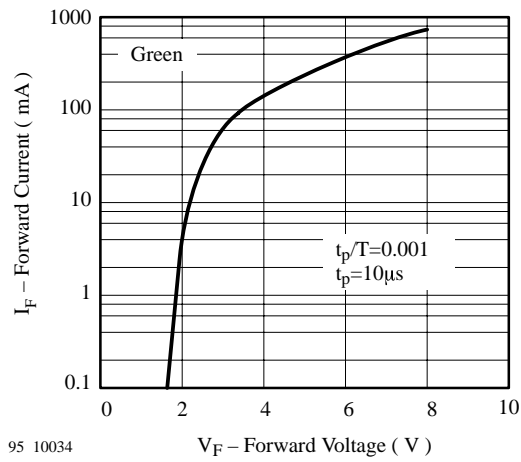
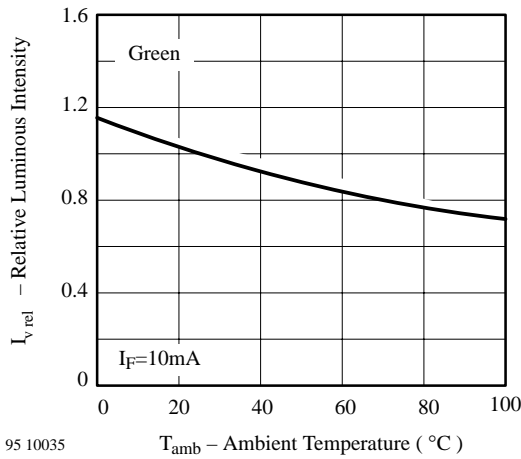
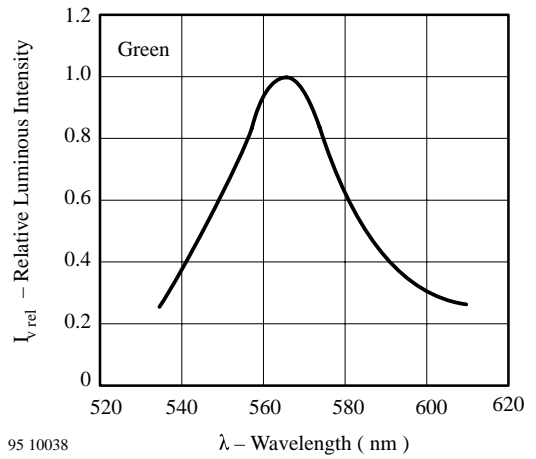

Figure 10 Forward Current vs. Forward Voltage



95 10035

Figure 11 Rel. Luminous Intensity vs. Ambient Temperature



95 10038

Figure 14 Relative Luminous Intensity vs. Wavelength

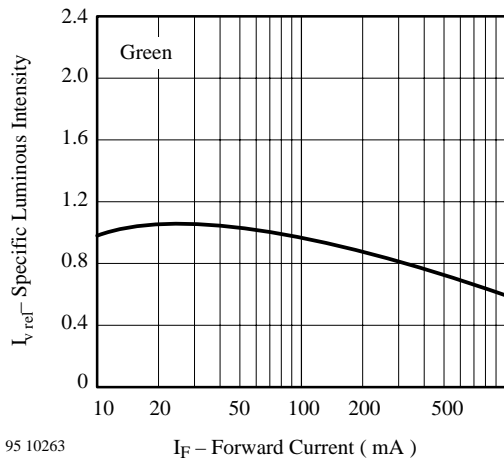

95 10263

Figure 12 Specific Luminous Intensity vs. Forward Current

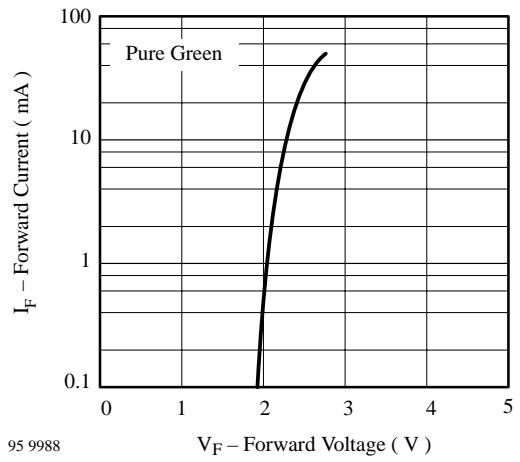

95 9988

Figure 15 Rel. Luminous Intensity vs. Ambient Temperature

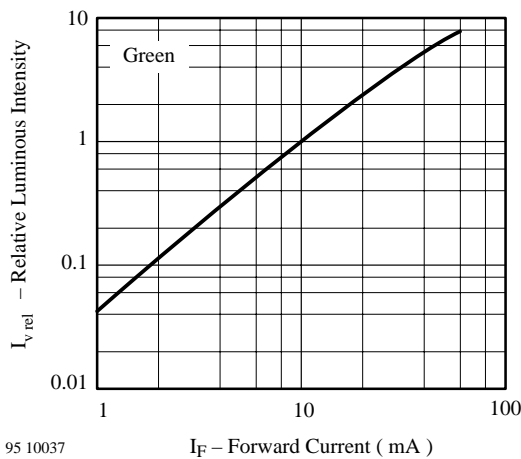

95 10037

Figure 13 Relative Luminous Intensity vs. Forward Current

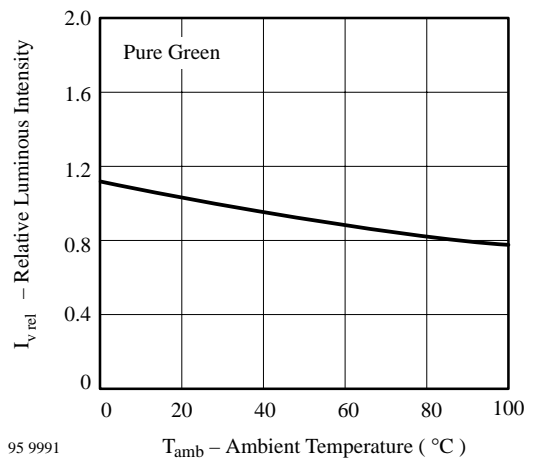

95 9991

Figure 16 Rel. Luminous Intensity vs. Ambient Temperature

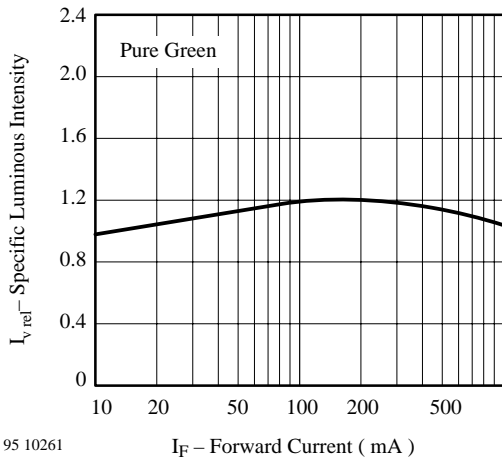

Figure 17 Specific Luminous Intensity vs. Forward Current

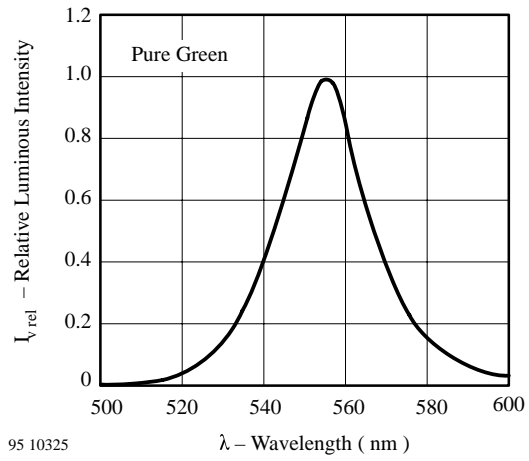

Figure 19 Relative Luminous Intensity vs. Wavelength

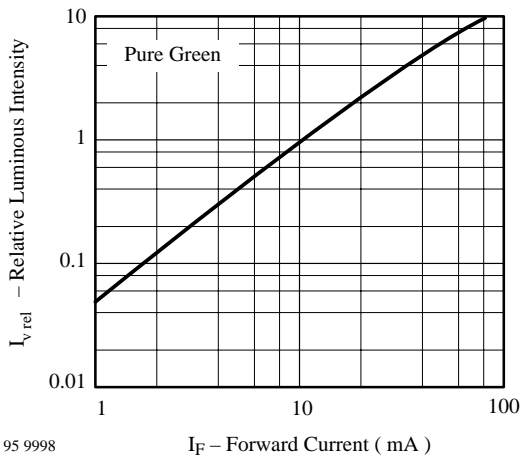
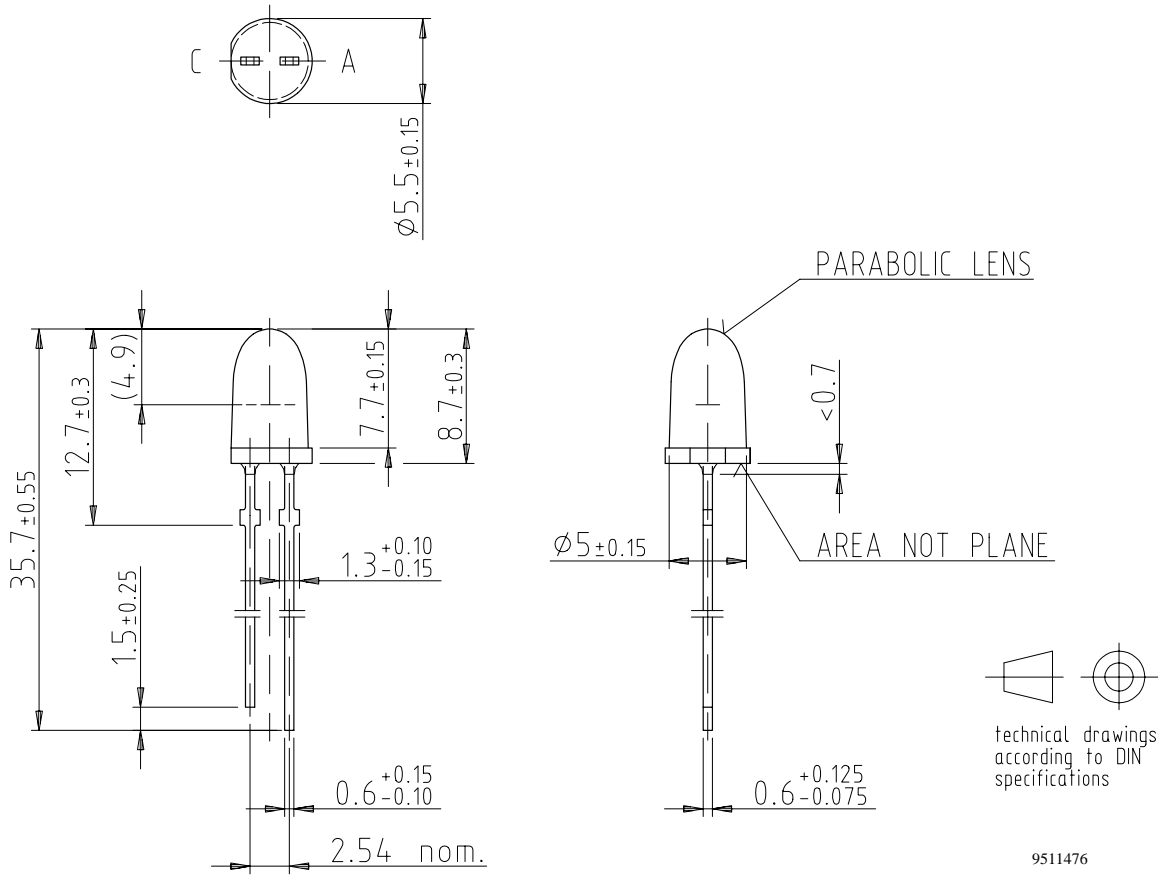

Figure 18 Relative Luminous Intensity vs. Forward Current

Dimensions in mm



Ozone Depleting Substances Policy Statement

It is the policy of **Vishay Semiconductor GmbH** to

1. Meet all present and future national and international statutory requirements.
2. Regularly and continuously improve the performance of our products, processes, distribution and operating systems with respect to their impact on the health and safety of our employees and the public, as well as their impact on the environment.

It is particular concern to control or eliminate releases of those substances into the atmosphere which are known as ozone depleting substances (ODSs).

The Montreal Protocol (1987) and its London Amendments (1990) intend to severely restrict the use of ODSs and forbid their use within the next ten years. Various national and international initiatives are pressing for an earlier ban on these substances.

Vishay Semiconductor GmbH has been able to use its policy of continuous improvements to eliminate the use of ODSs listed in the following documents.

1. Annex A, B and list of transitional substances of the Montreal Protocol and the London Amendments respectively
2. Class I and II ozone depleting substances in the Clean Air Act Amendments of 1990 by the Environmental Protection Agency (EPA) in the USA
3. Council Decision 88/540/EEC and 91/690/EEC Annex A, B and C (transitional substances) respectively.

Vishay Semiconductor GmbH can certify that our semiconductors are not manufactured with ozone depleting substances and do not contain such substances.

We reserve the right to make changes to improve technical design and may do so without further notice.

Parameters can vary in different applications. All operating parameters must be validated for each customer application by the customer. Should the buyer use Vishay-Telefunken products for any unintended or unauthorized application, the buyer shall indemnify Vishay-Telefunken against all claims, costs, damages, and expenses, arising out of, directly or indirectly, any claim of personal damage, injury or death associated with such unintended or unauthorized use.

Vishay Semiconductor GmbH, P.O.B. 3535, D-74025 Heilbronn, Germany
Telephone: 49 (0) 7131 67 2831, Fax number: 49 (0) 7131 67 2423

Компания «Океан Электроники» предлагает заключение долгосрочных отношений при поставках импортных электронных компонентов на взаимовыгодных условиях!

Наши преимущества:

- Поставка оригинальных импортных электронных компонентов напрямую с производств Америки, Европы и Азии, а так же с крупнейших складов мира;
- Широкая линейка поставок активных и пассивных импортных электронных компонентов (более 30 млн. наименований);
- Поставка сложных, дефицитных, либо снятых с производства позиций;
- Оперативные сроки поставки под заказ (от 5 рабочих дней);
- Экспресс доставка в любую точку России;
- Помощь Конструкторского Отдела и консультации квалифицированных инженеров;
- Техническая поддержка проекта, помощь в подборе аналогов, поставка прототипов;
- Поставка электронных компонентов под контролем ВП;
- Система менеджмента качества сертифицирована по Международному стандарту ISO 9001;
- При необходимости вся продукция военного и аэрокосмического назначения проходит испытания и сертификацию в лаборатории (по согласованию с заказчиком);
- Поставка специализированных компонентов военного и аэрокосмического уровня качества (Xilinx, Altera, Analog Devices, Intersil, Interpoint, Microsemi, Actel, Aeroflex, Peregrine, VPT, Syfer, Eurofarad, Texas Instruments, MS Kennedy, Miteq, Cobham, E2V, MA-COM, Hittite, Mini-Circuits, General Dynamics и др.);

Компания «Океан Электроники» является официальным дистрибьютором и эксклюзивным представителем в России одного из крупнейших производителей разъемов военного и аэрокосмического назначения «JONHON», а так же официальным дистрибьютором и эксклюзивным представителем в России производителя высокотехнологичных и надежных решений для передачи СВЧ сигналов «FORSTAR».



JONHON

«JONHON» (основан в 1970 г.)

Разъемы специального, военного и аэрокосмического назначения:

(Применяются в военной, авиационной, аэрокосмической, морской, железнодорожной, горно- и нефтедобывающей отраслях промышленности)

«FORSTAR» (основан в 1998 г.)

ВЧ соединители, коаксиальные кабели, кабельные сборки и микроволновые компоненты:

(Применяются в телекоммуникациях гражданского и специального назначения, в средствах связи, РЛС, а так же военной, авиационной и аэрокосмической отраслях промышленности).



Телефон: 8 (812) 309-75-97 (многоканальный)

Факс: 8 (812) 320-03-32

Электронная почта: ocean@oceanchips.ru

Web: <http://oceanchips.ru/>

Адрес: 198099, г. Санкт-Петербург, ул. Калинина, д. 2, корп. 4, лит. А